

# Multi-Channel Hipot Tester

GPT-9500 Series

---

USER MANUAL



ISO-9001 CERTIFIED MANUFACTURER

**GW INSTEK**

This manual contains proprietary information, which is protected by copyright. All rights are reserved. No part of this manual may be photocopied, reproduced or translated to another language without prior written consent of Good Will company.

The information in this manual was correct at the time of printing. However, Good Will continues to improve products and reserves the rights to change specification, equipment, and maintenance procedures at any time without notice.

---

---

# Table of Contents

<b>SAFETY INSTRUCTIONS .....</b>	<b>5</b>
<b>GETTING STARTED .....</b>	<b>9</b>
GPT-9500 Series Overview .....	10
Front Panel Overview .....	14
Rear Panel Overview .....	18
Status Bar .....	21
Set Up.....	23
<b>OPERATION .....</b>	<b>31</b>
Menu Tree .....	33
Test Lead Connection .....	39
MANU Tests .....	40
AUTO Tests.....	91
<b>UTILITY .....</b>	<b>141</b>
System Setting .....	143
Test Setting .....	163
Interface Setting .....	190
<b>EXTERNAL CONTROL.....</b>	<b>199</b>
External Control Overview.....	200
<b>REMOTE CONTROL .....</b>	<b>204</b>
Interface Configuration .....	205
Command Syntax.....	209
Command List .....	211
<b>APPENDIX .....</b>	<b>289</b>
Fuse Replacement.....	289
Test Errors .....	290

Factory Default Parameters .....	291
Status System.....	292
GPT-9500 Specifications .....	293
GPT-9503/9513 Dimensions.....	298
Declaration of Conformity .....	299
<b>INDEX.....</b>	<b>300</b>

# S SAFETY INSTRUCTIONS

This chapter contains important safety instructions that you must follow during operation and storage. Read the following before any operation to ensure your safety and to keep the instrument in the best possible condition.

## Safety Symbols

These safety symbols may appear in this manual or on the instrument.

---



WARNING

Warning: Identifies conditions or practices that could result in injury or loss of life.



CAUTION

Caution: Identifies conditions or practices that could result in damage to the instrument or to other properties.



DANGER High Voltage



Attention Refer to the Manual



Protective Conductor Terminal



Frame or Chassis Terminal



Earth (ground) Terminal



Do not dispose electronic equipment as unsorted municipal waste. Please use a separate collection facility or contact the supplier from which this instrument was purchased.

## Safety Guidelines

---

General Guideline • Do not place any heavy object on the instrument.



CAUTION

- Avoid severe impact or rough handling that leads to damaging the instrument.
- Do not discharge static electricity to the instrument.
- Use only mating connectors, not bare wires, for the terminals.
- Do not block the cooling fan opening.
- Do not disassemble the GPT-9500 unless you are qualified.

Position Guideline • The rear position of the GPT-9500 should be placed in an area with easy accessible for power disconnection, that is, unplugging the power cord with ease.



WARNING

- Keep away from the device under test which connects with the GPT-9500 when test is underway. In addition, while test is ongoing, never touch the device under test, the GPT-9500 as well as other relevant units.
- Any inappropriate manner that is unspecified by the manufacturer may result in irreversible harms or impaired protection by the GPT-9500.

(Measurement categories) EN 61010-1:2010 specifies the measurement categories and their requirements as follows. The GPT-9500 does not fall under category II, III or IV.

- Measurement category IV is for measurement performed at the source of low-voltage installation.
  - Measurement category III is for measurement performed in the building installation.
  - Measurement category II is for measurement performed on the circuits directly connected to the low voltage installation.
- 

#### Power Supply



WARNING

- AC Input voltage range:  
AC 100V – 240V  $\pm$  10%
  - Frequency: 50Hz/60Hz
  - To avoid electrical shock connect the protective grounding conductor of the AC power cord to an earth ground.
- 

#### Cleaning the GPT-9500

- Disconnect the power cord before cleaning.
  - Use a soft cloth dampened in a solution of mild detergent and water. Do not spray any liquid.
  - Do not use chemicals containing harsh material such as benzene, toluene, xylene, and acetone.
- 

#### Operation Environment

- Location: Indoor, no direct sunlight, dust free, almost non-conductive pollution (Note below)
- Relative Humidity:  $\leq$  70% (no condensation)
- Altitude: < 2000m
- Temperature: 0°C~40°C

(Pollution Degree) EN 61010-1:2010 specifies the pollution degrees and their requirements as follows. The GPT-9500 falls under degree 2.

Pollution refers to "addition of foreign matter, solid, liquid, or gaseous (ionized gases), that may produce a reduction of dielectric strength or surface resistivity".

- Pollution degree 1: No pollution or only dry, non-conductive pollution occurs. The pollution has no influence.
- Pollution degree 2: Normally only non-conductive pollution occurs. Occasionally, however, a temporary conductivity caused by condensation must be expected.
- Pollution degree 3: Conductive pollution occurs, or dry, non-conductive pollution occurs which becomes conductive due to condensation which is expected. In such conditions, equipment is normally protected against exposure to direct sunlight, precipitation, and full wind pressure, but neither temperature nor humidity is controlled.

---

#### Storage environment

- Location: Indoor
- Temperature:  $-10^{\circ}\text{C}$  to  $70^{\circ}\text{C}$
- Relative Humidity:  $\leq 85\%$  (no condensation)

---

#### Disposal



Do not dispose this instrument as unsorted municipal waste. Please use a separate collection facility or contact the supplier from which this instrument was purchased. Please make sure discarded electrical waste is properly recycled to reduce environmental impact.

# G GETTING STARTED

This chapter describes the safety analyzer in a nutshell, including its main features and front / rear panel introduction. After going through the overview, please read the safety considerations in the Set Up chapter.

---

<b>GPT-9500 Series Overview .....</b>	<b>10</b>
Series lineup .....	10
Lineup Overview .....	11
Main Features .....	11
Accessories .....	12
Package Contents .....	13
<b>Front Panel Overview .....</b>	<b>14</b>
GPT-9503/9513 .....	14
<b>Rear Panel Overview .....</b>	<b>18</b>
GPT-9503/9513 .....	18
<b>Status Bar .....</b>	<b>21</b>
<b>Set Up .....</b>	<b>23</b>
Tilting the Stand .....	23
Line Voltage Connection and Power Up .....	24
How to edit parameter value promptly .....	25
Workplace Precautions .....	27
Operating Precautions .....	28
Basic Safety Checks .....	30

## GPT-9500 Series Overview

### Series lineup

The GPT-9500 Series are multi-channel AC/DC withstanding voltage and insulation resistance safety tester.

The GPT-9513 is AC/DC withstanding voltage and insulation resistance tester with 8 channels scan – Hi & Lo setup functions. The GPT-9503 is AC/DC withstanding voltage and insulation resistance tester with 8 channels scan – Hi setup functions. For the all models, the testing terminals are also mirrored on the rear panel for added safety and for more permanent safety testing environments.

The GPT-9500 Series can store up to 501 manual tests, and run up to 99 manual tests sequentially within an automatic test, allowing the safety testers to accommodate any number of safety standards, including IEC, EN, UL, CSA, GB, JIS and others.

Note: Throughout this user manual, the terms ACW, DCW and IR, refer to AC Withstanding, DC Withstanding and Insulation Resistance testing, respectively.

## Lineup Overview

Model name	ACW	DCW	IR	Scan - Hi	Scan - Lo
GPT-9503	✓	✓	✓	✓	
GPT-9513	✓	✓	✓	✓	✓

## Main Features

Performance	<ul style="list-style-type: none"> <li>• ACW: 5kVAC</li> <li>• DCW: 6kVDC</li> <li>• IR: 50V~1kV</li> <li>• 8-CH Scanner</li> </ul>
Features	<ul style="list-style-type: none"> <li>• Ramp up time control</li> <li>• Fall time control</li> <li>• Safety discharge</li> <li>• 501 test conditions (MANU mode)</li> <li>• 99 steps per group (AUTO mode)</li> <li>• 99 groups for total 500 memory locations (AUTO mode)</li> <li>• Over temperature, voltage and current protection</li> <li>• View, Edit, Ready, Test, Stop, High Voltage and Pass, Fail indicators</li> <li>• Interlock (configurable)</li> </ul>
Interface	<ul style="list-style-type: none"> <li>• RS232/USB interface for programming</li> <li>• Signal I/O port for pass/fail/test monitoring and start/stop control</li> <li>• Interlock terminal for safety operation</li> </ul>

## Accessories

Standard Accessories	Part number	Description
	GHT-115 x 1*	Test lead set
	GHT-116B x 1*	Test lead (Black)
	GHT-116R x 8*	Test lead (Red)
	Region dependent	Power cord
	N/A	Interlock wire
	* Please refer to the packing list since the accessories may vary.	
Optional Accessories	Part number	Description
	GHT-205	High Voltage Test Probe
	GHT-113	High Voltage Test Pistol
	GTL-236	RS232C cable
	GTL-246	USB cable (A to B type)

## Package Contents

Check the contents before using the GPT-9500 series.

### Opening the box

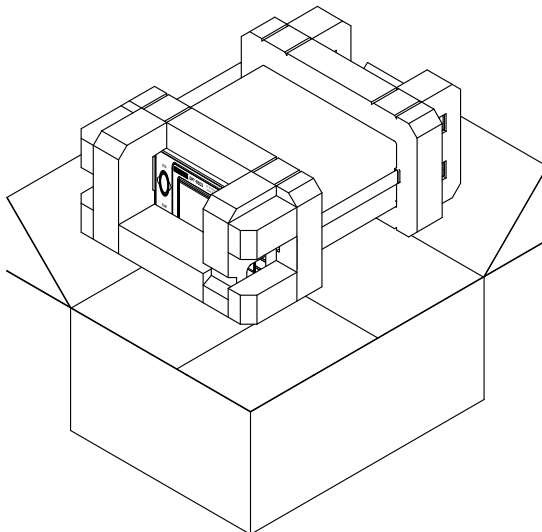

Contents (single unit)	• GPT-9500 unit	• GHT-115 test lead x1*
	• Quick Start Guide	• GHT-116B test lead x 1 (Black) *
	• User manual CD	• GHT-116R test leads x 8 (Red) *
	• Power cord x1 (region dependent)	• Interlock wire

\* Please refer to the packing list since the accessories may vary.



Note

Keep the packaging, including the box, polystyrene foam and plastic envelopes should the need arise to return the unit to GW Instek.

## Front Panel Overview

GPT-9503/9513

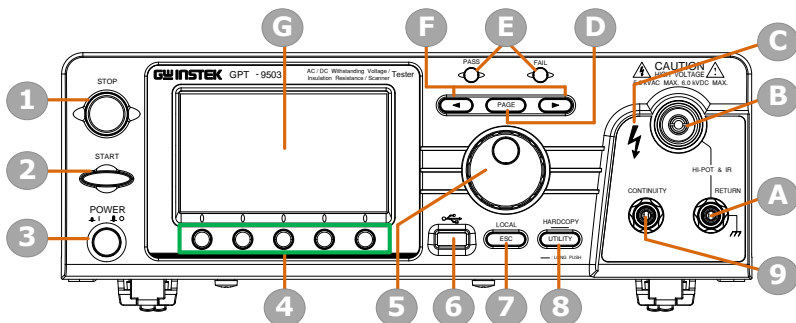

Item	Description
1	STOP Button
2	START Button
3	POWER Switch
4	Soft Keys (Green Zone)
5	Scroll Wheel
6	USB A-Type Host Port
7	ESC/LOCAL Key
8	UTILITY/HARDCOPY key
9	CONTINUITY Terminal
A	RETURN Terminal
B	HIGH VOLTAGE Output Terminal
C	HIGH VOLTAGE Indicator
D	PAGE Key
E	PASS/FAIL Indicators
F	Arrow Keys
G	Display

STOP button

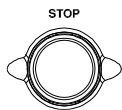

The STOP button is used to stop/cancel tests. The STOP button will also put the tester in the READY status to begin testing.

START button



The START button is used to start tests. The START button can be used to start tests when the tester is in the READY status. Pressing the START button will put the tester in the TEST status.

POWER switch



Turns the power on. The tester will always start up with the AUTO (0) test setting display.

Soft Keys

The Soft keys correspond to the menu keys directly above on the main display.

Scroll wheel



The scroll wheel is used to edit parameter values. Be aware that faster the scroll speed, bigger the value digits can be set and vice versa.

USB Host Port

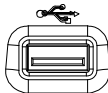

It can connect with USB flash drive for parameter storage and firmware upgrade. Also, it is available for screenshot hardcopy in association with the Hardcopy key.

ESC/LOCAL Key



ESC allows user to return to previous page. LOCAL switches operation back to local mode from remote mode

UTILITY/  
HARDCOPY key

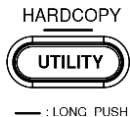

UTILITY changes to the main utility setting page. Long press HARDCOPY key for 1 second to take a screenshot. Make sure an USB flash disk is inserted before the action.

CONTINUITY  
terminal



The CONTINUITY terminal (red) is used for CONT (Continuity) test. Refer to page 104 for test lead connection of CONTINUITY.

RETURN terminal

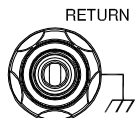

The RETURN terminal (black) is used for ACW, DCW and IR tests.

HIGH VOLTAGE  
output terminal

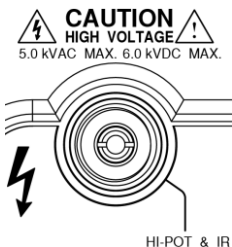

The HIGH VOLTAGE terminal output is used for outputting the testing voltage in ACW, DCW and IR tests. The terminal is recessed for safety. This terminal is used in conjunction with the RETURN terminal.

HIGH VOLTAGE  
indicator



The HIGH VOLTAGE indicator will light up red when an output terminal is active. Only after the test has finished or stopped will the indicator turn off.

PAGE Key



It is used to change among different pages concerning parameter editing or AUTO mode displays.

PASS/FAIL  
indicators

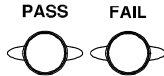

The PASS and FAIL indicators light up upon a PASS or FAIL test result at the end of a MANU test or AUTO test.

Arrow Keys



The arrow keys are used to select the digit of a value that is being edited.

Display

4.3" Color TFT LCD display in 480 X 272 resolution

## Rear Panel Overview

GPT-9503/9513

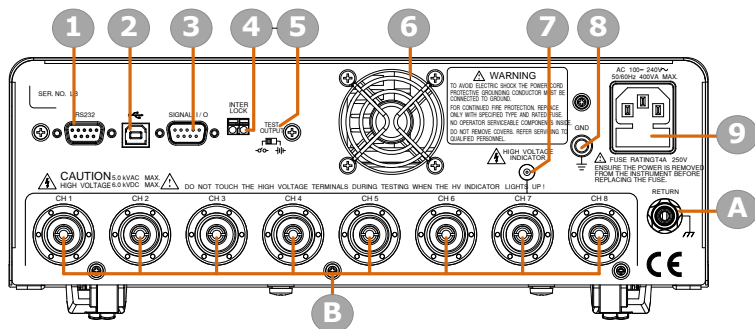

Item	Description
1	RS232 Interface Port
2	USB B-Type Interface Port
3	Signal I/O Port
4	INTERLOCK Terminal
5	TEST OUTPUT Switch
6	Fan
7	HIGH VOLTAGE Indicator
8	GND
9	AC Mains Input (Power Cord Socket)
A	RETURN Terminal
B	HIGH VOLTAGE Output/RETURN Terminals from CH1 - CH8 (RETURN function is only available for GPT-9513)

RS232 Interface Port

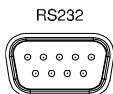

The RS232 port is used for remote control.

USB B-Type Interface Port



The USB B-Type port is used for remote control.

SIGNAL I/O port

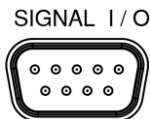

The SIGNAL I/O port is used to monitor the tester status (PASS, FAIL, TEST) and input (START/STOP signals).

INTERLOCK Terminal



The INTERLOCK terminal is used to connect with interlock wire for safety operation.

TEST OUTPUT switch



When SIGNAL I/O is utilized, depending on the applied device, it can be toggled between power symbol and contact symbol.



Contact symbol      Power symbol

Fan/Fan Vents

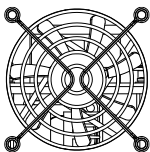

Exhaust fan. Allow enough room for the fan to vent. Do not block the fan openings.

HIGH VOLTAGE Indicator

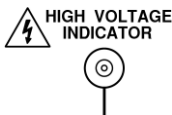

The HIGH VOLTAGE indicator will light up when an output terminal is active. Only after the test has finished or stopped will the lamp turn off.

GND



Connect the GND (ground) terminal to the earth ground.

AC Mains Input

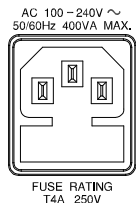

AC Mains Input for Power Cord Socket: 100 - 240 VAC  $\pm$ 10%.

The fuse holder contains the AC mains fuse. For fuse replacement details, see page 45.

RETURN terminal

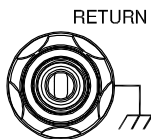

The RETURN terminal is used for ACW, DCW and IR tests. Note that it can be shared by HIGH VOLTAGE output terminals (CH1 - CH8) jointly at the same time.

HIGH VOLTAGE output terminals (CH1 - CH8)

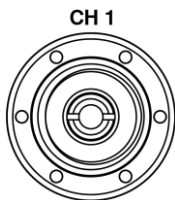

The HIGH VOLTAGE terminals outputs (CH1 - CH8) are used for outputting the testing voltage in ACW, DCW and IR tests. The terminals are recessed for safety and used in conjunction with the RETURN terminal.

|

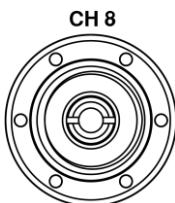

For GPT-9513, all channels are selectable for HV output, L-Return and non-used, whilst all channels of GPT-9503 are selectable for HV output and non-used only.

 **WARNING**

**USE WITH EXTREME CAUTION.** Do not touch the HIGH VOLTAGE terminal during testing.







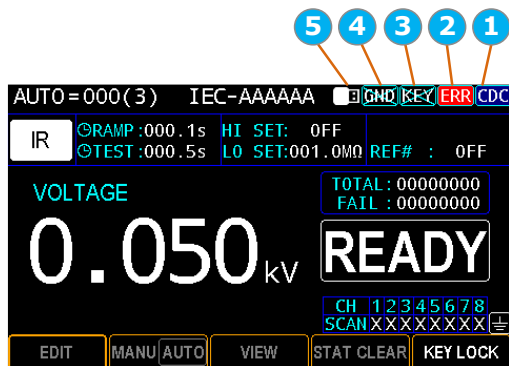

## Status Bar

**Background** Identify each icon within the top status bar.

**Status Bar Display**



Item	Description
1	RMT/RS232/USB-CDC/USB-TMC icon
2	Error icon for commands from remote control
3	Panel Key Lock activation icon
4	Power GND Check activation icon
5	USB flash drive connection icon

Remote Control		It indicates the unit is under remote control. Refer to page 204 for details.
RS232		It indicates RS-232 interface is activated. Refer to page 190 and 206 for details.
USB - CDC		It indicates USB - CDC interface is activated. Refer to page 190 and 205 for details.
USB - TMC		It indicates USB - TMC interface is activated. Refer to page 190 and 205 for details.
ERROR		It indicates error occurs in command of remote control. To erase the error icon, it is required to read or sweep the error by remote control commands or reboot action. Refer to page 285 for details.
Panel Key Lock		It indicates the Panel Key Lock function is enabled. Refer to page for 81 details.
Power GND Check		It indicates the Power GND Check function is enabled. Refer to page for 166 details.
USB Flash Drive – connected		It indicates the USB flash drive is well connected with unit and ready for storage, firmware upgrade or screenshot hardcopy.
USB Flash Drive – not available		It indicates something error occurs and thus USB flash drive fails to connect to unit. Usually this icon shows for few seconds firstly when flash drive is being connected to unit since the inserted flash drive is in the process of being identified by unit.

## Set Up

### Tilting the Stand

---

Horizontal position

Place the unit on a flat surface horizontally.

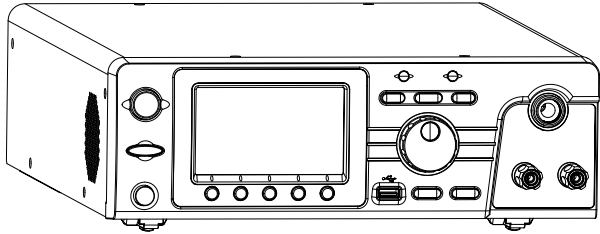

Tilt stand position Gently pull the 2 stands out from the bottom and the unit will be placed in the tilt stand position.

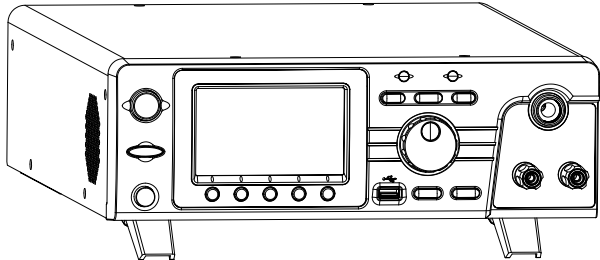

## Line Voltage Connection and Power Up

**Background**                      The GPT-9500 accepts line voltages of 100 - 240V at 50Hz or 60Hz.

**Steps**                              1. Connect the power cord to the AC Mains Input socket on the rear panel.

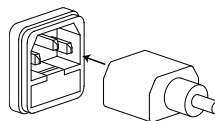

2. If the power cord does not have an earth ground, ensure the ground terminal is connected to an earth ground.

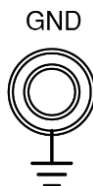

 **Warning**

Ensure the power cord is connected to an earth ground. Failure could be harmful to the operator and instrument.

3. Press the Power button.

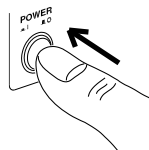

4. When the unit is powered up, the display will show the group 0 of AUTO test mode as shown in the figure below.

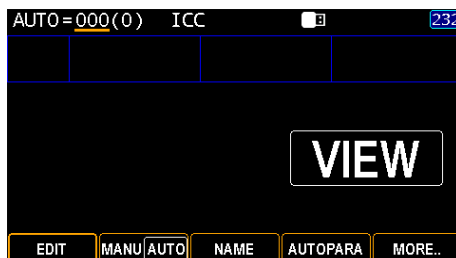

## How to edit parameter value promptly

**Background** The GPT-9500 Tester generally uses the scroll wheel, arrow keys and Enter key to edit numerical values. The following section will explain some tips in detail.

**Steps to edit a value in MANU test**

1. Under MANU test, press the EDIT soft-key followed by pressing the RAMP TIME soft-key to enter the parameter field.



2. The selected parameter (RAMP) will be underlined in orange. Use the scroll wheel to increase or decrease the value.



3. Use the arrow keys to move the cursor to a target digit of the desired value.



4. Turn the scroll wheel again to edit the value of the selected digit.

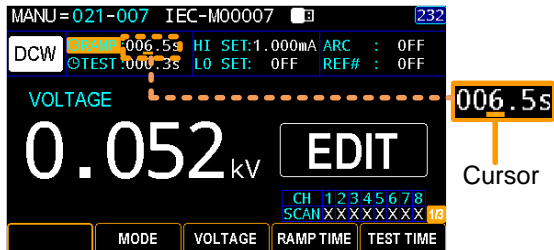

5. Repeat the steps above for all the relevant digits.
6. Press the SAVE soft-key to complete.

A rectangular button with a black border and the word "SAVE" in white capital letters on a black background.

Note

By default the value to be edited starts at the lowest digit with cursor covering the entire value. By pressing the arrow keys the cursor will move to each digit.

## Workplace Precautions

---

**Background**                      The GPT-9500 is a high voltage instrument that outputs dangerous voltages. The following section describes precautions and procedures that must be followed to ensure a safe work environment.

---



### WARNING

The GPT-9500 generates voltages in excess of 5kVAC or 6kVDC. Follow all safety precautions, warnings and directions given in the following section when using the instrument.

---

1. Only technically qualified personnel should be allowed to operate the hipot tester.
2. The operating workplace must be fully isolated, especially when the instrument is in operation. The instrument should be clearly labeled with appropriate warning signage.
3. The operator should not wear any conductive materials, jewelry, badges, or other items, such as wrist watches.
4. The operator should wear insulation gloves for high voltage protection.
5. Ensure the earth ground of the line voltage is properly grounded.
6. Ensure any devices that are adversely affected by magnetic fields are not placed near the tester.

## Operating Precautions

---

**Background**            The GPT-9500 is a high voltage instrument that outputs dangerous voltages. The following section describes precautions and procedures that must be followed to ensure that the tester is operated in a safe manner.

---



### WARNING

The GPT-9500 generates voltages of up to 5kVAC or 6kVDC. Follow all safety precautions, warnings and directions given in the following section when using the instrument.

---

1. Never touch the hipot tester, lead wires, terminals, probes and other connected equipment when the tester is testing.
2. Do not turn the hipot tester on and off quickly or repeatedly. When turning the power off, please allow a few moments before turning the power back on. This will allow the protection circuits to properly initialize.

Do not turn the power off when a test is running, unless in an emergency.

3. Only use those test leads supplied with the instrument. Leads with inappropriate gauges can be dangerous to both the operator and the instrument.
4. Do not short the HIGH VOLTAGE terminal with ground. Doing so could charge the chassis to dangerously high voltages.
5. Ensure the earth ground of the line voltage is properly grounded.

6. Only connect the test leads to the HIGH VOLTAGE terminals before the start of a test. Keep the test leads disconnected at all other times.
7. Always press the STOP button when pausing testing.
8. Do not leave the hipot tester unattended. Always turn the power off when leaving the testing area.
9. When remotely controlling the hipot tester, ensure adequate safety measures are in place to prevent:
  - Inadvertent output of the test voltage.
  - Accidental contact with the instrument during testing. Ensure that the instrument and DUT are fully isolated when the instrument is remotely controlled.
10. Ensure an adequate discharge time for the DUT.

When DCW or IR tests are performed, the DUT, test leads and probes become highly charged. The GPT-9500 has discharge circuitry to discharge the DUT after each test. The time required for a DUT to discharge depends on the DUT and test voltage.

Never disconnect the hipot tester before a discharge is completed.

## Basic Safety Checks

---

**Background**                      The GPT-9500 tester is a high voltage device and as such, daily safety checks should be made to ensure safe operation.

---

1. Ensure all test leads are not broken and are free from defects such as cracks or splitting.
  2. Ensure the tester is always connected to an earth ground.
  3. Test the tester operation with a low voltage/current output:  
Ensure the tester generates a FAIL judgment when the HIGH VOLTAGE and RETURN terminals are shorted (using the lowest voltage/current as the testing parameters).
- 



### WARNING

Do not use high voltages/currents when the HIGH VOLTAGE and RETURN terminals are shorted. It may result in damage to the instrument.

---

# O PERATION

---

<b>Menu Tree</b> .....	<b>33</b>
Menu Tree Overview .....	34
<b>Test Lead Connection</b> .....	<b>39</b>
ACW, DCW, IR Connection.....	39
<b>MANU Tests</b> .....	<b>40</b>
Choose/Recall a MANU Test Number .....	41
Setting the MANU Test Mode .....	43
Setting the Test Voltage.....	44
Setting the Ramp UP Time .....	45
Setting the Test Time.....	47
Setting the Upper and Lower Limits.....	50
Setting the ARC Detection .....	52
Setting a Reference Value .....	53
Setting the Scan Arrangement .....	55
Creating a MANU Test Name.....	57
Setting the Wait Time.....	59
Setting the Fall Time .....	61
Setting the Grounding Mode .....	63
Setting the IR Test Range.....	67
Setting OFFSET reference value .....	68
Viewing the Parameters Settings .....	70
Setting the Pause (PA) Step .....	72
Setting the Open Short Check (OSC) Step.....	75
Copy a MANU step .....	78
Clear the tests state .....	80

Set the Panel Key Lock.....	81
Running a MANU Test.....	83
PASS / FAIL MANU Test .....	87
<b>AUTO Tests .....</b>	<b>91</b>
Choose/Recall an AUTO Test .....	92
Creating an AUTO Test Name .....	93
Adding a MANU Step to the AUTO Test .....	94
Viewing and Editing AUTO Group .....	95
Setting AUTO Parameters .....	97
Getting the Reference Value .....	111
Getting the Standard Value.....	113
Viewing Steps in AUTO Group .....	115
Viewing Parameters Settings of Each Step in List ..	117
Page View in AUTO Test .....	118
Clear the tests state .....	121
Set a Panel Key Lock.....	122
Running an Automatic Test .....	124
AUTO Test Results .....	135

# Menu Tree

This section describes the overall structure of the operation statuses and modes for the GPT-9500 tester, which has two main testing modes (MANU, AUTO), one utility mode (UTILITY) and 5 main operation statuses (VIEW, EDIT, READY, TEST and STOP).

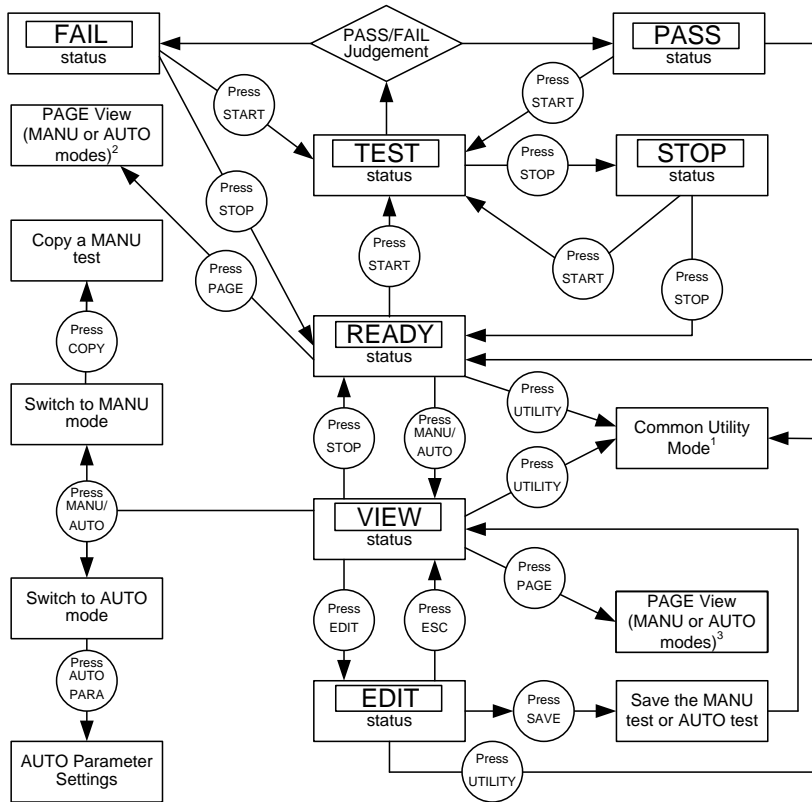

1 Press ESC to return to the previous screen.  
 2 The specific PAGE view for MANU or AUTO modes under READY status  
 3 The specific PAGE view for MANU or AUTO modes under VIEW status

## Menu Tree Overview

**MANU Mode** MANU mode is used to create and/or execute a single test. Only under MANU mode can parameters be edited for each manual test.

MANU mode

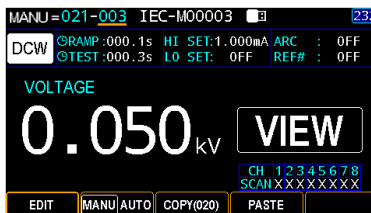

**AUTO Mode**

AUTO mode indicates that the tester is automatic, which consists of a sequential AUTO test of up to 99 MANU steps.

AUTO mode

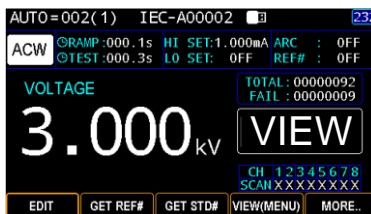

**UTILITY Mode**

UTILITY mode covers the System, Test as well as Interface settings, which are system-wide and applied to both MANU and partially AUTO tests.

UTILITY mode

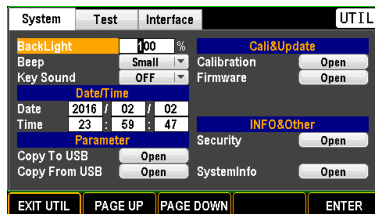

Page View for VIEW status

Under VIEW status, pressing PAGE key to see each parameter in detail for MANU mode or to see detailed parameters within a list table for AUTO mode.

Page VIEW for MANU mode under VIEW status

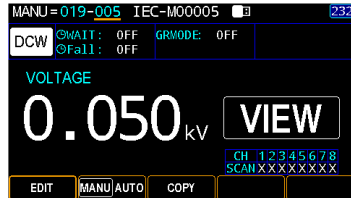

Page VIEW for AUTO mode under VIEW status

SN	STEP	MODE	VOLT	HI SET	LO SET	SCAN
01	001	DCW	0.068kV	1.000mA	OFF	XXXXXXXXXX
02	003	DCW	0.050kV	7.606mA	OFF	HLXXXXXXXX
03	007	DCW	0.052kV	1.000mA	OFF	XXXXXXXXXX
04	002	OSC	0.050kV	STD# =>	000µA	XXXXXXXXXX
05	013	IR	0.050kV	OFF	001.0MΩ	XXXXXXXXXX

Buttons at the bottom: EDIT, MANU/AUTO, NAME, AUTOPARA, MORE..

Page View for READY status

Under READY status, pressing PAGE key to see measured values with judgments in detail of each channel for MANU mode (only available when scan function is enabled, refer to page 55) or to see measured values with judgments within a list table for AUTO mode.

Page VIEW for MANU mode under READY status

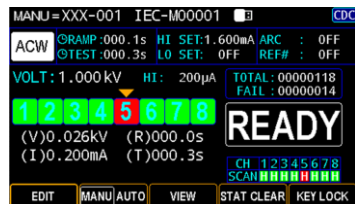

Page VIEW for AUTO mode under READY status

SN	STEP	MODE	VOLT	CURR/OHM	STATUS	SCAN
01	004	ACW	2.998kV	0.000mA	PASS	XXXXXXXXXX
02	006	DCW	0.050kV	0.0µA	PASS	XXXXXXXXXX
03	060	OSC	0.050kV	0.006mA	PASS	XXXXXXXXXX
04	025	DCW	0.050kV	0.0µA	PASS	XXXXXXXXXX

Buttons at the bottom: READY

**VIEW Status**

VIEW status is used to view the parameters of the selected MANU test/AUTO test. Also, pressing the PAGE key under VIEW status can switch to specific page view for MANU or AUTO mode.

VIEW status in MANU test

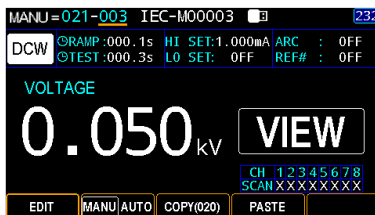

VIEW status in AUTO test

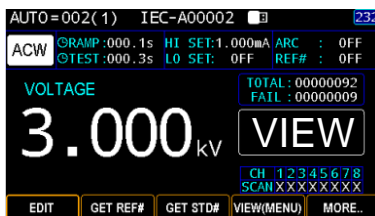

**EDIT Status**

EDIT status is used to edit the MANU test or AUTO test parameters. Pressing the EDIT/SAVE key will save any changes. Pressing the ESC key will cancel any changes.

EDIT status in MANU test

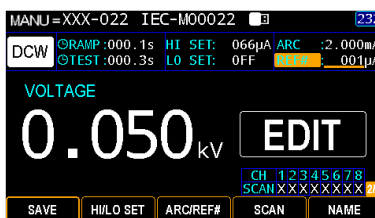

EDIT status in AUTO test

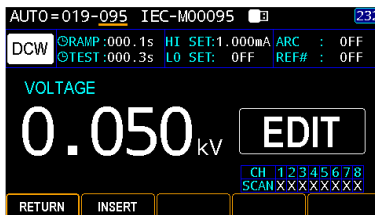

READY Status

When the tester is in READY status of MANU or AUTO test, it is ready to begin testing. Pressing the START button will begin testing and put the tester into TEST status. Pressing the MANU/AUTO soft-key will return the tester to VIEW status. Also, pressing the PAGE key under READY status can switch to specific page view for MANU or AUTO mode.

READY status in MANU test

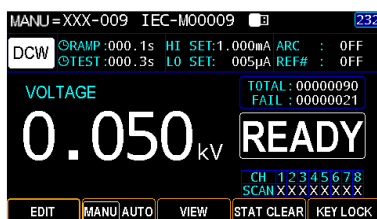

READY status in AUTO test

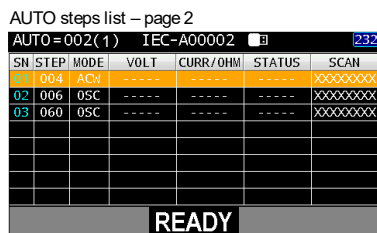

**TEST Status**

TEST status is active when a MANU test or AUTO test is running. Pressing STOP will cancel the MANU test or the remaining steps in an AUTO test instantly.

TEST status in MANU test

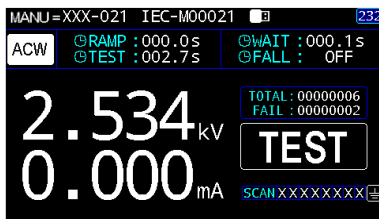

TEST status in AUTO test

AUTO = 021-007 IEC-A00021						
SN	STEP	MODE	VOLT	CURR/OHM	STATUS	SCAN
01	001	DCW	0.069kV	0.01A	PASS	XXXXXXXXXX
02	003	DCW	0.050kV	0.01A	PASS	HLXXXXXXXX
03	007	DCW	0.022kV	0.01A	TEST	XXXXXXXXXX
04	002	OSC	-----	-----	-----	XXXXXXXXXX
05	013	IR	-----	-----	-----	XXXXXXXXXX

  

P/N: AA-0166	<b>TEST</b>	RAMP TIME: 003.8s
L/N: B_2		
S/N: BEF.997		

**STOP Status**

STOP status is shown when a MANU or an AUTO test did not finish running and has been stopped by user. Pressing STOP will return the tester to READY status.

STOP status in MANU test

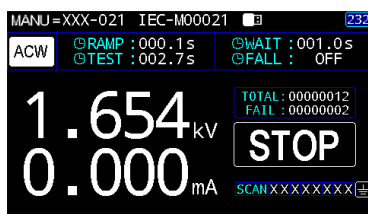

STOP status in AUTO test

AUTO = 021-001 IEC-A00021						
SN	STEP	MODE	VOLT	CURR/OHM	STATUS	SCAN
01	001	DCW	0.038kV	0.01A	STOP	XXXXXXXXXX
02	003	DCW	-----	-----	-----	HLXXXXXXXX
03	007	DCW	-----	-----	-----	XXXXXXXXXX
04	002	OSC	-----	-----	-----	XXXXXXXXXX
05	013	IR	-----	-----	-----	XXXXXXXXXX

P/N: AA-0166	<b>STOP</b>	
L/N: B_2		
S/N: BEF.997		

## Test Lead Connection

This section describes how to connect the GPT-9500 to a DUT for ACW withstanding, DCW withstanding as well as insulation resistance testing.

### ACW, DCW, IR Connection

---

**Background** ACW, DCW and IR tests use the HIGH VOLTAGE terminal and RETURN terminal with the GHT-115 test leads.

---

**ACW, DCW, IR Connection**

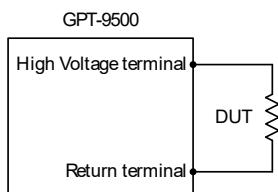

- Steps**
1. Turn the power off on the tester.
  2. Connect the high voltage test lead (red) to the HIGH VOLTAGE terminal and screw firmly into place.
  3. Connect the return test lead (white) into the RETURN terminal and screw the protector bar into place, as shown below.

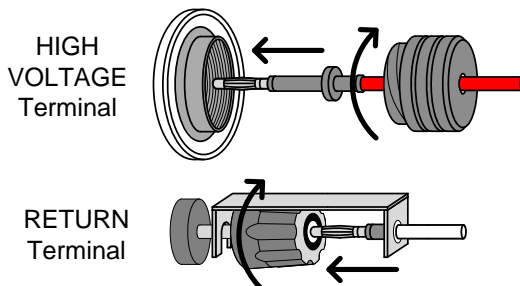

## MANU Tests

This section describes how to create, edit and run ACW, DCW and IR manual tests. Each MANU setting described in this chapter only applies to the selected manual test - no other manual tests are affected.

Each manual test can be stored/recalled to/from one of 501 memory locations. Each stored manual test can be used as a test step when creating an AUTO test (page 91).



- Choose/Recall a MANU Test Number → from page 41.
- Setting the MANU Test Mode → from page 43.
- Setting the Test Voltage → from page 44.
- Setting the Ramp UP Time → from page 45.
- Setting the Test Time → from page 47.
- Setting the Upper and Lower Limits → from page 50.
- Setting the ARC Detection → from page 52.
- Setting a Reference Value → from page 53.
- Setting the Scan Arrangement → from page 55.
- Creating a MANU Test Name → from page 57.
- Setting the Wait Time → from page 59.
- Setting the Fall Time → from page 61.
- Setting the Grounding Mode → from page 63.
- Setting the IR Test Range → from page 67.
- Setting OFFSET reference value → from page 68.
- Viewing the Parameters Settings → from page 70.
- Setting the Pause (PA) Step → from page 72.
- Setting the Open Short Check (OSC) Step → from page 75.
- Copy a MANU step → from page 78.
- Clear the MANU tests state → from page 80.
- Set the Panel Key Lock → from page 81.
- Running a MANU Test → from page 83.
- PASS / FAIL MANU Test → from page 87.

## Choose/Recall a MANU Test Number

---

**Background** AC Withstand (ACW), DC Withstand (DCW), Insulation Resistance (IR), Pause (PA) and Open Short Check (OSC) modes can only be created and edited in the MANU mode. MANU number 001 to 500 can be saved and thus be loaded when editing/creating a MANU test or an AUTO test. MANU number 000 acts like a trial mode in that it could not be added into AUTO test.

---

- Steps**
1. Press the MANU/AUTO soft-key to select MANU option. 
  2. Use the scroll wheel to choose the MANU number. 
- MANU #      000~500  
(MANU# 000 acts like a trial mode)
- 



Note

The MANU test number can only be chosen in VIEW status.

**MANU Number Description**

The following “MANU=XXX-019” stands for the MANU step 019 of the AUTO group XXX. The XXX simply means this MANU step doesn’t belong to any AUTO group.

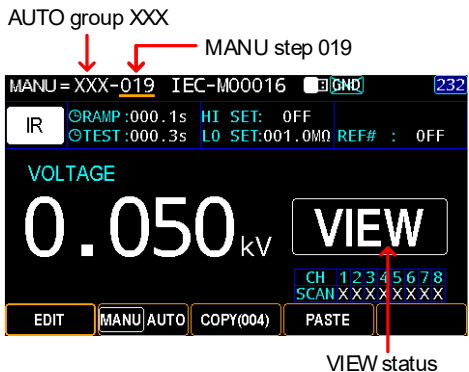



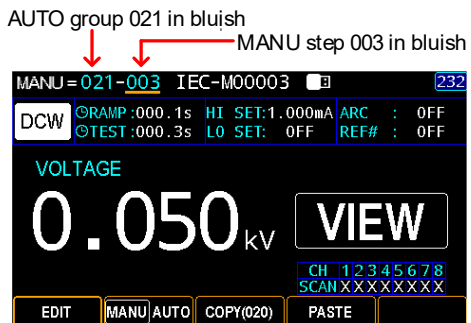

Note

When MANU step has been added to AUTO group, the number of AUTO group shows in the prefix (021 in the case below) and the full MANU number turn out bluish.



## Setting the MANU Test Mode

**Background**                      Essentially, there are 5 modes, AC Withstand (ACW), DC Withstand (DCW), Insulation Resistance (IR), Pause (PA) and Open Short Check (OSC) modes. Precisely, the previous 3 (ACW, DCW and IR) are for both MANU and AUTO tests, whereas the rest 2 (PA and OSC) are for AUTO test only.

- Steps**
1. Press the MANU/AUTO soft-key to select MANU option. 
  2. Press the EDIT soft-key followed by clicking the MODE soft-key.   

  3. Navigate the scroll wheel to toggle between 5 modes. Further press the SAVE soft-key to confirm the selection.   

- ACW            AC Withstand (MANU, AUTO)
- DCW            DC Withstand (MANU, AUTO)
- IR                Insulation Resistance (MANU, AUTO)
- PA                Pause action(AUTO)
- OSC             Open Short Check action(AUTO)

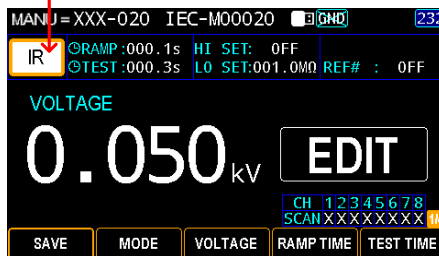



Selected MANU Test Mode



4. Press the SAVE soft-key to complete. 

## Setting the Test Voltage

**Background**                      The test voltage can be set from 0.050kV to 5kV for ACW, 0.050kV to 6kV for DCW and 0.050kV to 1kV for IR.

- Steps**
1. Press the MANU/AUTO soft-key to select MANU option. 
  2. Press the EDIT soft-key followed by clicking the VOLTAGE soft-key.   

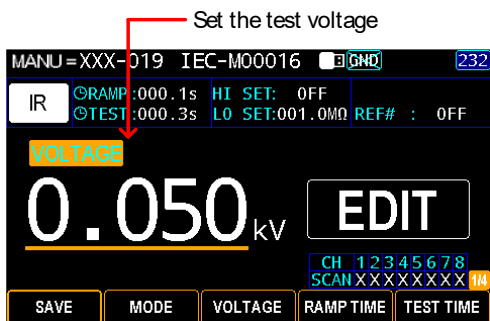
  3. Use the scroll wheel to set the test voltage. 
- ACW                      0.050kV ~ 5kV  
 DCW                      0.050kV ~ 6kV  
 IR                          0.050kV ~ 1kV



4. Press the SAVE soft-key to complete. 



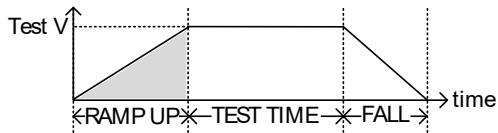

## Setting the Ramp UP Time

**Background** The Ramp Up time is the total time taken for the tester to reach the test voltage level. The Ramp Up time can be set from 000.1 to 999.9 seconds. The Ramp Up time is applicable for ACW, DCW and IR tests.

**Output Voltage Timing Chart (Resistive load)**



**Steps**

1. Press the MANU/AUTO soft-key  to select MANU option.
2. Press the EDIT soft-key followed by clicking the RAMP TIME soft-key.   

3. Use the scroll wheel to set the ramp up time. 

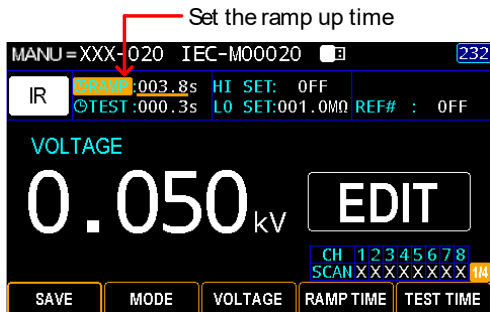
ACW 000.1s~999.9s  
 DCW 000.1s~999.9s  
 IR 000.1s~999.9s



4. Press the SAVE soft-key to complete.



Ramp Time  
Duration Indicator

After pressing START to begin MANU test with set RAMP TIME, a section at the upper left corner of display shows the countdown duration of RAMP TIME, which will run for the full course of set value followed by the set test time.

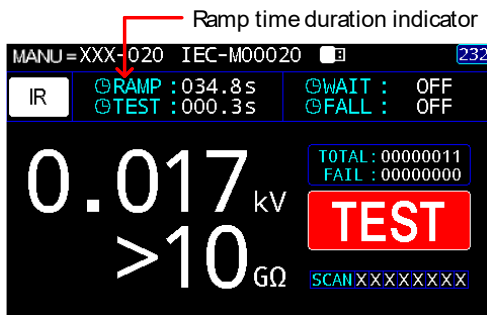

## Setting the Test Time

**Background** This setting is used to set the test time for a test. The test time determines how long the test voltage is applied to DUT. This test time does not include RAMP UP time or FALL time. The test time can be set from 0.3 seconds to 999.9 seconds for ACW, DCW and IR tests, with a resolution of 0.1 seconds for all modes. Also, the test time can be set "CONT." for all 3 modes.

Output Voltage  
Timing Chart  
(Resistive load)

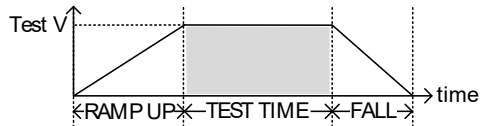

Steps

1. Press the MANU/AUTO soft-key to select MANU option.
2. Press the EDIT soft-key followed by clicking the TEST TIME soft-key.
3. Use the scroll wheel to set the TEST TIMER value.



ACW	000.3s~999.9s
DCW	000.3s~999.9s
IR	000.3s~999.9s

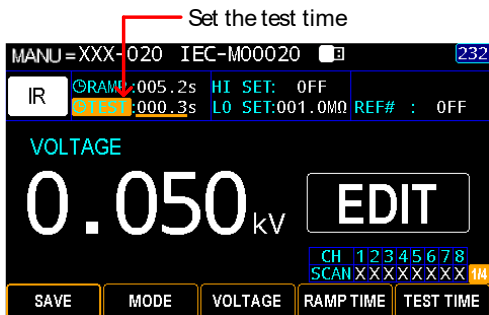

4. Press the SAVE soft-key to complete.



**CONT. Test Time**

When it is either ACW, DCW or IR test, the TEST TIME can be set CONT., which means the test time will last infinitely until FAIL judgment occurs.

Identical with the regular setting for TEST TIME, use the scroll wheel to set CONT. for TEST TIME value.

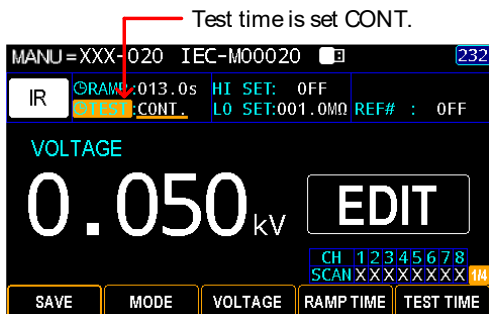

When setting greater than 40VA for DCW and greater than 100VA for ACW, respectively, the maximum test time is 600 seconds followed by the identical rest time.



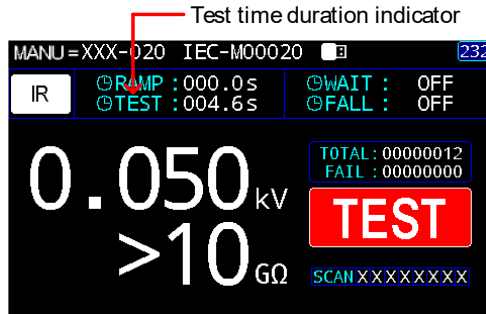

Test Time  
Duration Indicator

After pressing START to begin MANU test with set TEST TIME, a section at the upper left corner of display shows the countdown duration of set TEST TIME following the end of set RAMP TIME.



## Setting the Upper and Lower Limits

**Background** There is both a LOW and HI judgment setting. When the measured value is below the LOW SET setting, the test will be judged as FAIL. When the value exceeds the HI SET setting the test will be judged as FAIL. Any measurement between the LOW SET and HI SET setting is judged as PASS. The LOW SET limit cannot be made greater than the HI SET limit.

- Steps**
1. Press the MANU/AUTO soft-key to select MANU option. 
  2. Press the EDIT soft-key followed by clicking the PAGE key.   

  3. Press the HI/LO SET soft-key and then use the scroll wheel to set the HI SET limit.   

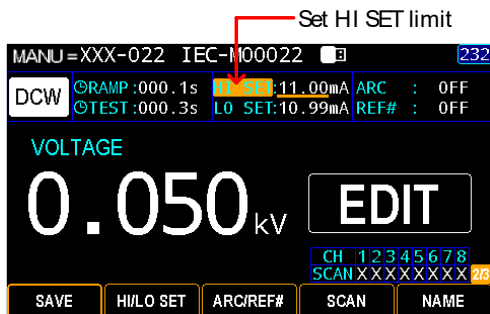
ACW (HI)	001 $\mu$ A~033.0mA
DCW (HI)	001 $\mu$ A~11.00mA
IR (HI)	000.2M $\Omega$ ~50.00G $\Omega$ , OFF



- Press the HI/LO SET soft-key and then use the scroll wheel to set the LO SET limit.



ACW (LO)	OFF, 001 $\mu$ A~32.99mA
DCW (LO)	OFF, 001 $\mu$ A~10.99mA
IR (LO)	000.1M $\Omega$ ~50.00G $\Omega$

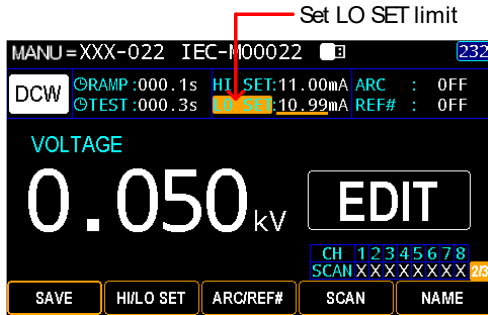

- Press the SAVE soft-key to complete.



Note

\*Please note that the resolution of the measured value depends on the resolution of HI SET setting.







Note

The LO SET setting is limited by the HI SET setting. The LO SET limit cannot be greater than the HI SET limit.

## Setting the ARC Detection

**Background**      ARC detection, otherwise known as flashover detection, detects fast voltage or current transients that are not normally detected. Arcing is usually an indicator of poor withstanding insulation, electrode gaps or other insulating problems that cause temporary spikes in current or voltage during ACW and DCW testing. ARC mode setting only applies to both ACW and DCW tests.

- Steps**
1. Press the MANU/AUTO soft-key to select MANU option. 
  2. Press the EDIT soft-key followed by clicking the PAGE key.   

  3. Press the ARC/REF# soft-key and then use the scroll wheel to set the threshold of ARC detection.   

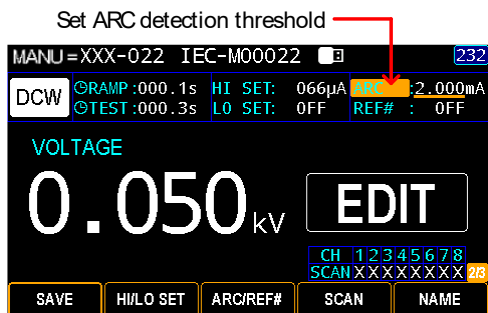





ACW                      OFF, 1.000mA~60.00mA  
 DCW                      OFF, 1.000mA~60.00mA



4. Press the SAVE soft-key to complete. 

## Setting a Reference Value

**Background**                      The REF# acts as an offset. The REF VALUE is subtracted from the measured current (ACW, DCW) or measured resistance (IR).

- Steps**
1. Press the MANU/AUTO soft-key to select MANU option. 
  
  2. Press the EDIT soft-key followed by clicking the PAGE key.   

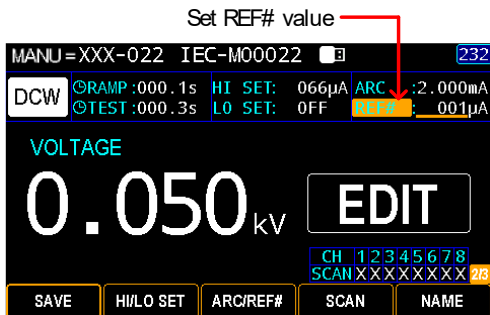
  
  3. For both ACW and DCW modes, press the ARC/REF# soft-key for two times and then use the scroll wheel to set the REF# value.   
  
 As for IR mode, press the REF# soft-key followed by using the scroll wheel to set the REF# value. 
- ACW              OFF, 001 $\mu$ A~HI SET current-0.1mA  
                          \*HI SET + REF value  $\leq$  33.00 mA
- DCW              OFF, 001 $\mu$ A~HI SET current-0.1mA  
                          \*HI SET + REF value  $\leq$  11.00 mA
- IR                  OFF, 000.1M $\Omega$ ~50.00G $\Omega$



4. Press the SAVE soft-key to complete.



Note



For IR test, an offset reference value of tester can be automatically created via the GR MODE and OFFSET functions. See page 68 for details.

## Setting the Scan Arrangement

---

**Background** As an 8-channel output hipot tester, up to 8 DUTs can be connected and tested with this tester simultaneously. Consequently, user is able to customize own deployments for each channel per varied applications.

There are 3 statuses available for each channel, which are "X" meaning open or no connection, "H" standing for Hi-POT & IR output and "L" signaling Return terminal.

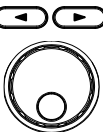
- |              |                                                                                                                                                                          |                                                                                    |
|--------------|--------------------------------------------------------------------------------------------------------------------------------------------------------------------------|------------------------------------------------------------------------------------|
| <b>Steps</b> | 1. Press the MANU/AUTO soft-key to select MANU option.                                                                                                                   |   |
|              | 2. Press the EDIT soft-key followed by clicking the PAGE key.                                                                                                            |   |
|              | 3. Press the SCAN soft-key to enter the SCAN setting.                                                                                                                    |   |
|              | 4. Use the left and right arrow keys to move among each channel, and utilize the scroll wheel to set the status for each channel in light of the practical applications. |  |
- H** Hi-POT/IR output  
**L** Return terminal  
**X** Open/No Connection



Only GPT-9513 supports L-Return terminal setup. The GPT-9503 is Not available for L setup.

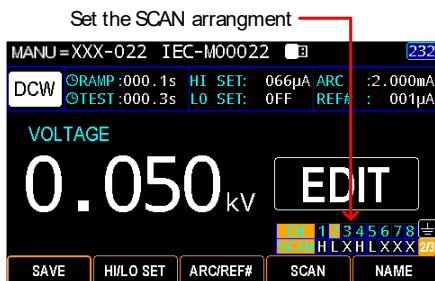

5. Press the SAVE soft-key to complete.



### Scan Judgments

After performing a test, if the “Step By Step Scan (page 188)” is activated, it is available to check judgments of each channel from display where green indicates the channels are passed, whilst red indicates the channel is failed.

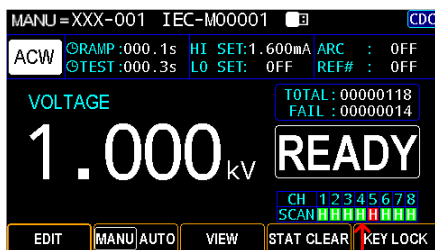

SCAN judgments after a test

Press the PAGE key and arrow keys to toggle scan details of each channel where info of test voltage (V), measured current (I), ramp up time (R) and test time (T) are displayed, individually.

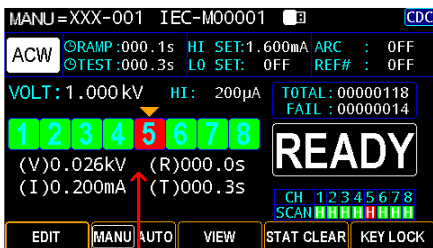

Judgment details of each channel



Note

When multiple channels are set “H” simultaneously, it is required to apply to the DUTs of identical property with total leaking current composed of the total amount from each channel. And properly adjust the set current value while considering the leaking current change from each DUT. Be aware that there is certain degree of uncertainty from this test. Be advised to manipulate multi-channels output test when DUTs are of high yield rate and stability.

## Creating a MANU Test Name

### Background

Each MANU test can have a user-defined name (default: IEC-M00XXX) up to 13 characters long. See the available list of characters below.

### Character List

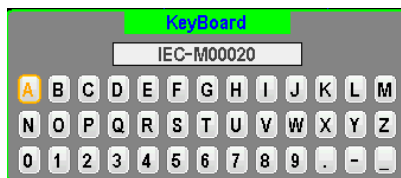

### Steps

1. Press the MANU/AUTO soft-key to select MANU option.



2. Press the EDIT soft-key followed by clicking the PAGE key.
 

EDIT
PAGE
  
3. Press the NAME soft-key to enter the NAME setting.
 

NAME
  
4. The on-screen keyboard is shown where user can input a preferred name for MANU test. Use the arrow keys or scroll wheel to move among each character and press INPUT soft-key to input character. Press CAPSLOCK soft-key to toggle between high and low case. Press BACKSPACE soft-key to backspace the inputted word. Press EXIT KeyB to exit from the KeyBoard and discard setting.

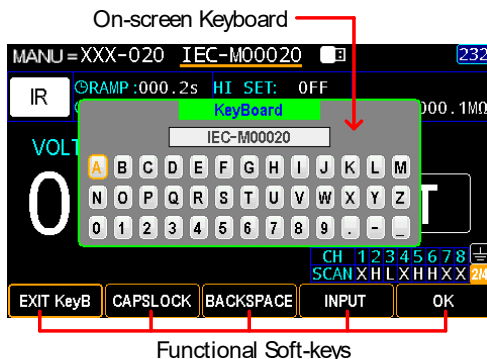

5. Press the OK soft-key to confirm input followed by pressing the SAVE soft-key to complete setting.
 

OK
SAVE

## Setting the Wait Time

---

### Background

The Wait Time refers to the pending time before judgment appears. Generally, test time begins after ramp up time; however, a wait time can be intervened between ramp up time and test and begins depending on relevant settings. See page 168 for details.

The Wait Time is applicable for ACW, DCW and IR tests.

### Steps

1. Press the MANU/AUTO soft-key to select MANU option.



2. Press the EDIT soft-key followed by clicking the PAGE key for twice.



3. Press the WAIT TIME soft-key followed by using the scroll wheel to set the WAIT TIME value.



ACW	OFF, 000.1s~999.9s
DCW	OFF, 000.1s~999.9s
IR	OFF, 000.1s~999.9s

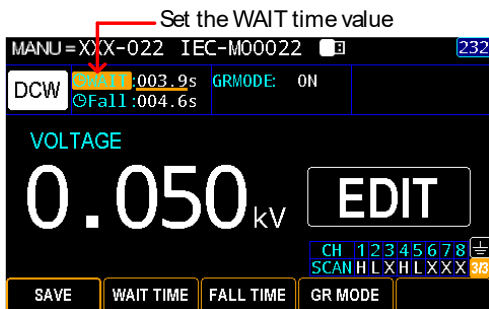

4. Press the SAVE soft-key to complete.



Wait Time Indicator

When performing MANU test, while the WAIT time is set, the indicator of WAIT time will be shown on the upper right corner of display counting down the set duration during a test progress.

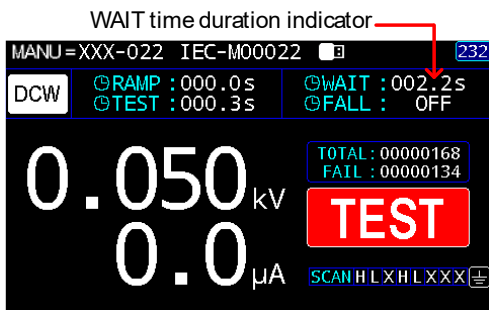

## Setting the Fall Time

**Background** The FALL time is the time taken for the DUT to discharge the test voltage level. The FALL time can be set from OFF to 999.9 seconds. The FALL time is applicable for ACW, DCW and IR tests.

**Output Voltage Timing Chart (Resistive load)**

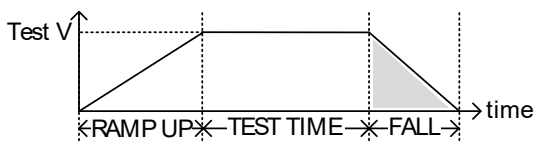

**Steps**

1. Press the MANU/AUTO soft-key to select MANU option.
2. Press the EDIT soft-key followed by clicking the PAGE key for twice.
3. Press the FALL TIME soft-key followed by using the scroll wheel to set the FALL TIME value.



ACW	OFF, 000.1s~999.9s
DCW	OFF, 000.1s~999.9s
IR	OFF, 000.1s~999.9s

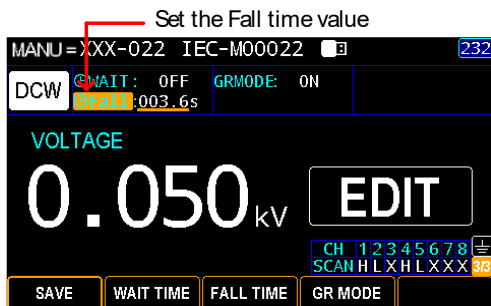

4. Press the SAVE soft-key to complete.



**FALL Duration Indicator**

When performing MANU test, after the set TEST TIME is fully completed, a section at the upper right corner of display shows the countdown duration of FALL time, which will run for the full course of set value by user. See the screenshot shown below.

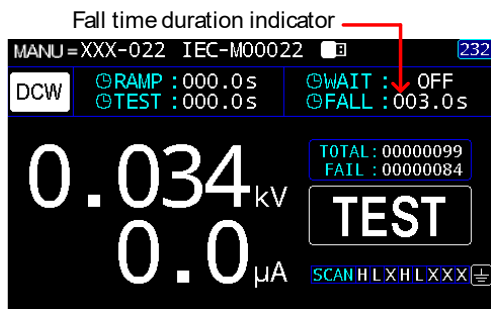

## Setting the Grounding Mode

### Background

When GROUND MODE is set to ON, the GPT-9500 grounds the return terminal to the ground. This mode is best for DUTs that are grounded to an earth ground by their chassis, fixtures or operation environment. This mode measures the potential of the HIGH VOLTAGE terminal with respect to earth ground. This means that additional noise which leaks to earth ground will also be measured. This is the safest testing mode, though potentially not as accurate.

When GROUND MODE is set to OFF, the return terminal is floating with respect to the earth ground. This mode is for DUTs that are floating and not directly connected to an earth ground. This is more accurate than when GROUND MODE is set to ON as less noise will be measured. For this reason, this testing mode is able to measure with better stability.

ACW/DCW, GROUND MODE ON, DUT grounded

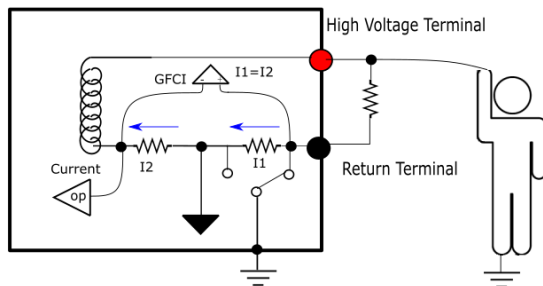

ACW/DCW, GROUND MODE OFF, DUT floating

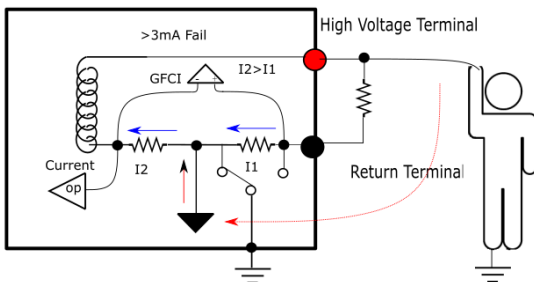

Note

If the current value, which results from comparison between I1 and I2 current, is above 3mA, once user unexpectedly touches the DUT, the GFCI, Ground Fault Circuit Interrupter, function activates and output will be stopped immediately so that protection mechanism will be well triggered at once.

IR, GROUND MODE ON, DUT grounded

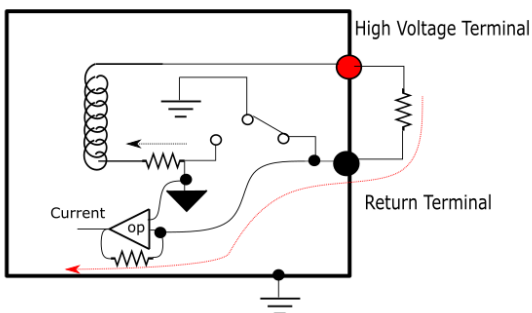

IR, GROUND MODE OFF, DUT floating

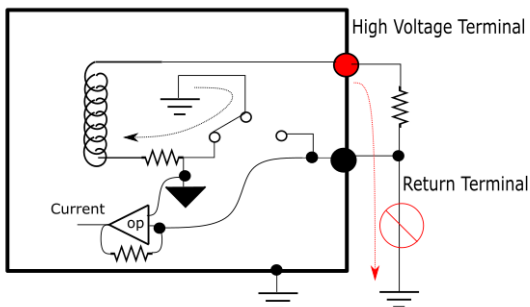

Warning

When GROUND MODE is set to OFF, the DUT, fixtures or connected instrumentation cannot be grounded. This will short circuit the internal circuitry during a test.

For ACW and DCW tests, if it is not known whether the DUT test setup is grounded or not, always set GROUND MODE to ON.

Only set GROUND MODE to OFF when the DUT is floating electrically.

Steps

1. Press the MANU/AUTO soft-key to select MANU option.



2. Press the EDIT soft-key followed by clicking the PAGE key for twice.



3. Press the GR MODE soft-key followed by using the scroll wheel to turn ON/OFF the ground mode.



GR MODE

ON, OFF

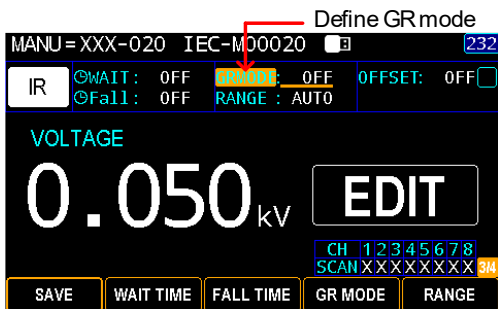

4. Press the SAVE soft-key to complete.





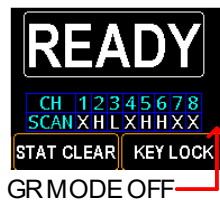
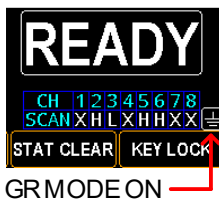

Ground mode icon

The GR MODE icon on the display appears accordingly.



## Setting the IR Test Range

**Background** Due to the measured current range in IR test is way to broader per varied DUT, it is suggested to select an appropriate current range for the applied DUT. This is only available for IR test.



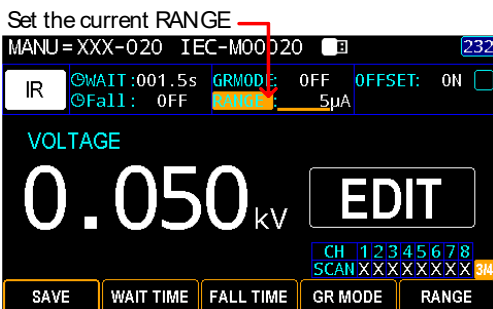

- Steps**
1. Press the MANU/AUTO soft-key to select MANU option. 
  2. Press the EDIT soft-key followed by clicking the PAGE key for twice.   

  3. Press the RANGE soft-key followed by using the scroll wheel to set the current range.   

- RANGE      5 $\mu$ A, 50 $\mu$ A, 500 $\mu$ A, 5mA, AUTO



4. Press the SAVE soft-key to complete. 

## Setting OFFSET reference value

**Background**                      The OFFSET is used to determine the offset resistance of the tester. It is imperative to turn ON GR MODE before setting OFFSET value. When an OFFSET is performed, the reference is automatically set to the measured resistance. This function is only applicable to IR test.

- Steps**
1. Press the MANU/AUTO soft-key to select MANU option. 
  2. Press the EDIT soft-key followed by clicking the PAGE key three times.   
 x 3
  3. Press the OFFSET soft-key followed by using the scroll wheel to turn ON/OFF the OFFSET function.   

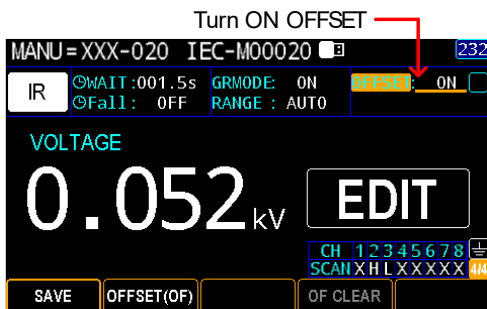
- OFFSET            ON, OFF

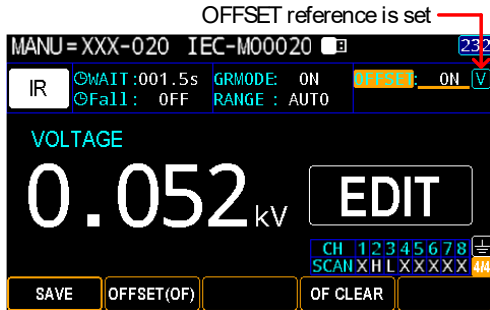
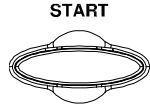

4. Press the SAVE soft-key to complete. 

- 5. Press the START button to perform the OFFSET function. The resistance of the tester, after the OFFSET has finished, will be added into the OFFEST field with an icon in proximity shown below.



OFFSET CLEAR

It is available to clear the set OFFSET reference value by clicking the OF CLEAR soft-key.



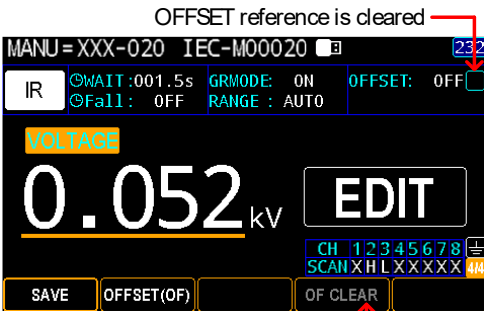

The OFFSET icon will be disappeared meaning no offset reference is set and the OF CLEAR soft-key will be grayed out accordingly.



OF CLEAR soft-key is grayed out

## Viewing the Parameters Settings

**Background** After setting up the parameters of each test mode (ACW, DCW and IR), user can check those settings anytime with ease.

- Steps**
1. Press the MANU/AUTO soft-key to select MANU option. 
  2. Use the scroll wheel to go to the target MANU step. 
  3. The parameters settings from each test mode are shown below. Use the PAGE key to toggle pages. 

DCW parameters – page 1

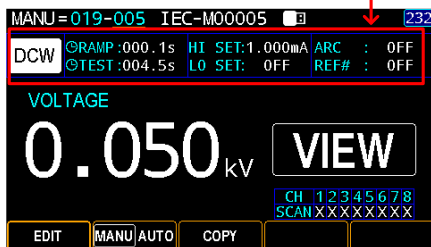

DCW

DCW parameters – page 2

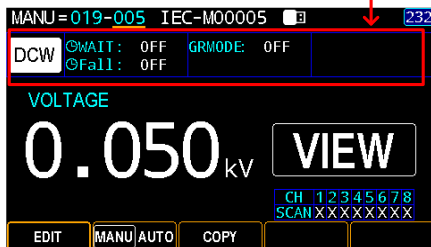

ACW parameters – page 1

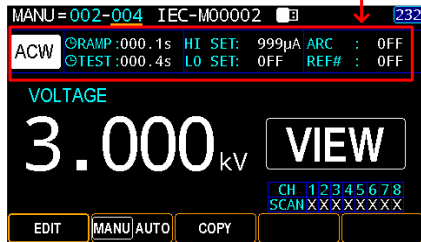

ACW

ACW parameters – page 2

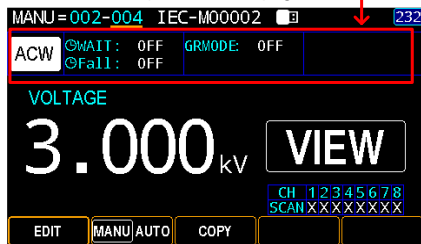

IR parameters – page 1

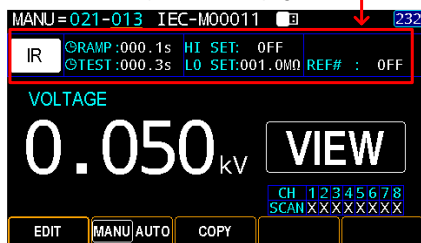



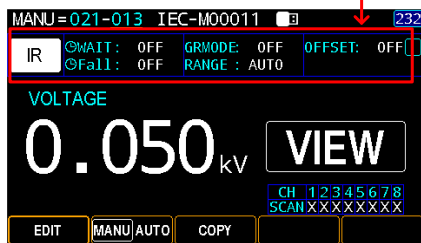

IR

IR parameters – page 2



## Setting the Pause (PA) Step

**Background** Basically, Pause (PA) step under MANU mode is specifically for AUTO mode. It provides, based on differed applications, a pause action, which is equivalent to an interval, within AUTO group. User is able to define some parameters for the set PA step.

- Steps**
1. Press the MANU/AUTO soft-key to select MANU option. 
  2. Press the EDIT soft-key followed by clicking the MODE soft-key. 
  3. Use the scroll wheel to select the PA option. 
  4. Press the TIME soft-key followed by using the scroll wheel to define a time period in which PA step will be shown on screen. 
- TIME** CONT.: Infinite time until START key  
000.3s~999.9s

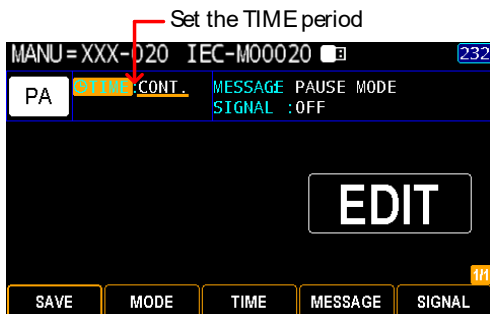

5. Press the MESSAGE soft-key to enter the Message setting, which will be shown when PA step endures. MESSAGE
  
6. The on-screen keyboard is shown where user can input a preferred Message for PA. Use the scroll wheel to move among each character and press INPUT soft-key to input character. Press CAPSLOCK soft-key to toggle between high and low case. Press BACKSPACE soft-key to backspace the inputted word. Press EXIT KeyB to exit from the KeyBoard and discard setting. MESSAGE

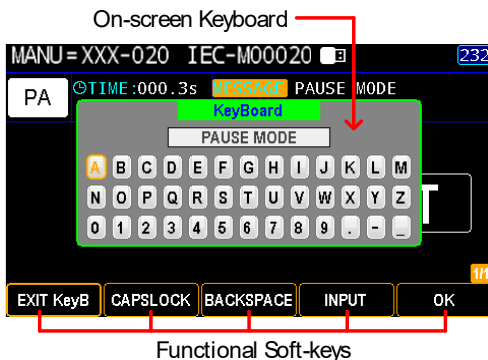

7. Press the OK soft-key to confirm. OK
  
  8. Press the SIGNAL soft-key followed by using the scroll wheel to turn ON/OFF Signal function, which outputs signal information including waveform of PA step to the connected external instrument. SIGNAL
- SIGNAL    ON, OFF

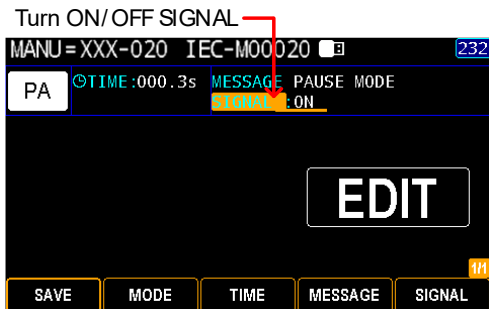

9. Press the SAVE soft-key to complete. SAVE

**PA Display**

While performing AUTO test where PA step is added, the screen will be shown as follows for PA step in which PAUSE TIME starts counting and the defined MESSAGE is clearly shown.

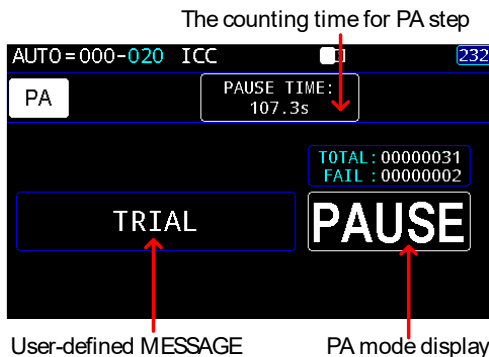







## Setting the Open Short Check (OSC) Step

---

**Background** Open Short Check (OSC) is a MANU step used to define the thresholds when open circuit or short circuit occurs between the test leads and DUT. The section here allows user to assign Hi limit and Low limit for Short and Open status check, respectively.

OSC, identical with the PA step, is specifically for AUTO mode. It provides an Open Short check step for multiple channels based on differed applications for AUTO tests.

---

- |              |                                                                                                               |                                                                                                                                                                           |
|--------------|---------------------------------------------------------------------------------------------------------------|---------------------------------------------------------------------------------------------------------------------------------------------------------------------------|
| <b>Steps</b> | 1. Press the MANU/AUTO soft-key to select MANU option.                                                        |                                                                                          |
|              | 2. Press the EDIT soft-key followed by clicking the MODE soft-key.                                            | <br>    |
|              | 3. Use the scroll wheel to select the OSC option.                                                             |                                                                                          |
|              | 4. Press the OPEN soft-key followed by using the scroll wheel to define a percentage of OPEN status judgment. | <br> |
- OPEN      10% ~ 100%

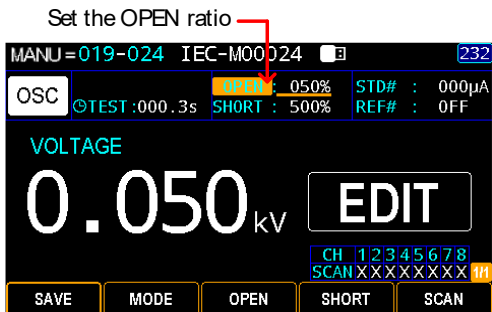

5. Press the SHORT soft-key followed by using the scroll wheel to define a percentage of SHORT status judgment.



SHORT OFF, 100% ~ 500%

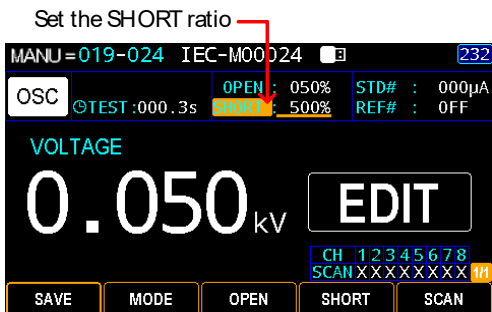

6. Press the SCAN soft-key to enter the SCAN setting.



7. Use the left and right arrow keys to move among each channel, and utilize the scroll wheel to set the status for each channel in light of the practical applications.



- H Hi-POT/IR output
- L Return terminal
- X Open/No Connection

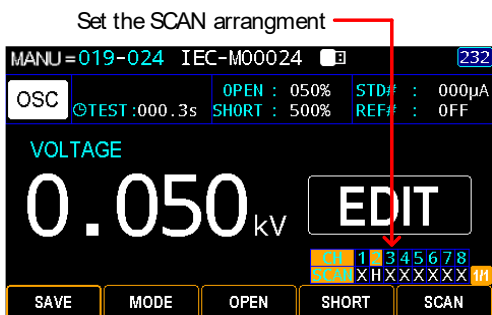

8. Press the SAVE soft-key to complete.



### OSC Display

Prior to executing OSC action, it is required to get a STD value, for which refer to the page 113. While performing AUTO test where OSC step is added, the screen will be shown as follows for OSC step in which FAIL judgments occurs in that either measured current value is lower than the set OPEN ratio or is higher than the SHORT ratio. In the case below, OPEN judgment comes up due to the measured current is lower than the OPEN threshold of user-defined 100% relative to the STD value.

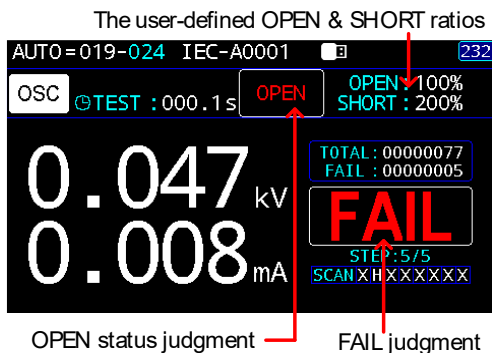

## Copy a MANU step

Background	In order promptly duplicate a MANU step, follow the steps below for easy setup.
Steps	<ol style="list-style-type: none"> <li>1. Make sure the unit is within the VIEW status under MANU mode. If it is under READY status, press the VIEW soft-key to return to the VIEW status. Alternatively, if it is under the EDIT status, press the SAVE soft-key to return to the VIEW status.</li> </ol>

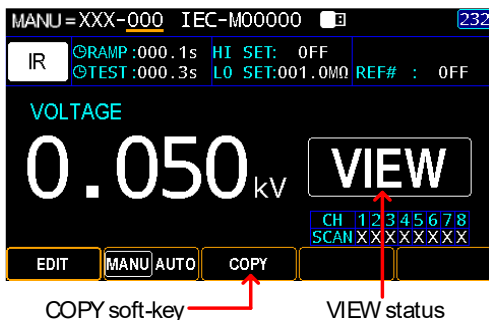

2. Use the scroll wheel to select a source MANU step number (000 for example) and press the COPY soft-key.
3. Further use the scroll wheel to select a target MANU step number (002 for example) and press the PASTE soft-key.



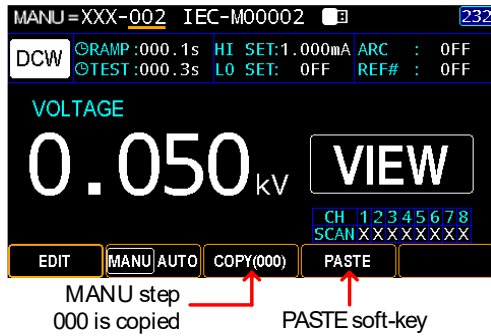

The MANU step number 000, from the example above, is replicated to the MANU step number 002 successfully.

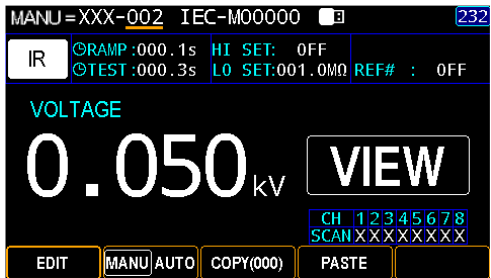

MANU step 002 has the identical parameters with MANU step 000

## Clear the tests state

### Background

The state covering TOTAL test counts and judgments of FAIL is clearly shown on the READY status. To erase the records, follow the steps below.

### Steps

1. Make sure the unit is within the READY status. If it is under VIEW status, press the STOP key to return to the READY status. Alternatively, if it is under the EDIT status, press the SAVE soft-key followed by the STOP key to return to the READY status.

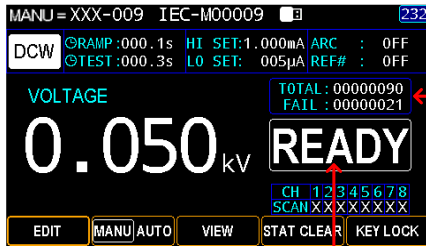

State table

READY status

TOTAL The total test counts  
FAIL The total FAIL judgments

2. Press and hold the STAT CLEAR

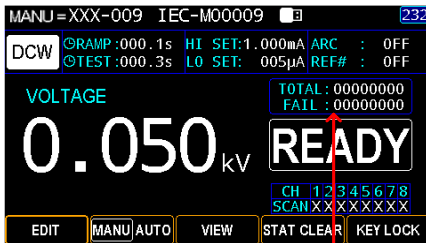

The tests state is zeroing

## Set the Panel Key Lock

**Background** Key Lock disables the front panel keys from changing the test number, mode or testing parameters. Only the START & STOP buttons required for testing are not disabled. Also, the KEY LOCK soft-key remains functional for user to unlock the function.

- Steps**
1. Make sure the unit is within the READY status under MANU mode. If it is under VIEW status, press the STOP key to return to the READY status. Alternatively, if it is under the EDIT status, press the SAVE soft-key followed by the STOP key to return to the READY status.

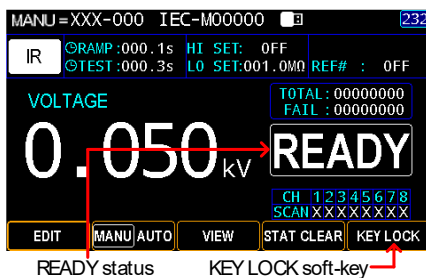

2. Press and hold the KEY LOCK soft-key for 1 second.



Unlock Key Lock

1. Again, press and hold the KEY LOCK soft-key for 1 second.



Functional Soft-keys

2. The on-screen keyboard is shown where user can input password to unlock the key lock. Use the scroll wheel to move among each number and press INPUT soft-key to input number. Press BACKSPACE soft-key to backspace the inputted word. Press EXIT PW to exit from the KeyBoard and discard setting.
3. Press the OK soft-key to unlock the KEY LOCK function.



Note

The password by default is 12345678.

## Running a MANU Test

**Background** A test can be run when the tester is in the READY status.



Note

The tester cannot start to run a test under the following conditions:

- A protection setting has been tripped; when a protection setting has been tripped the corresponding error message is displayed on the screen. See page 290 for a comprehensive list of the all the setting errors.
- The INTERLOCK function is ON and the Interlock wire is not shorted in the Interlock terminal (page 203).
- The STOP signal has been received remotely.
- If Double Action is ON, ensure the START button is pressed immediately after the STOP button (<0.5s).

**Steps**

1. Ensure the tester is in READY status for the test to come. Page 37

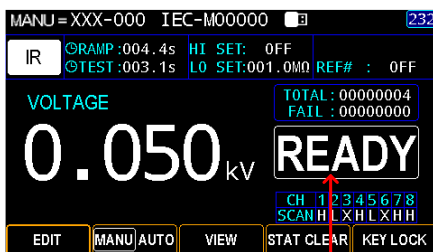

READY status →

- 2. Press the START button when the tester is in the READY status. The manual test starts accordingly and the tester goes into the TEST status.

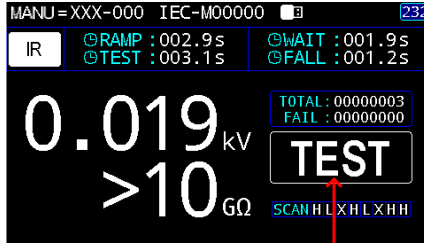
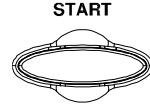

TEST status

- 3. The test will start by showing the ongoing RAMP time followed by ongoing WAIT time and the ongoing TEST time and, finally, the ongoing FALL time. The test will continue until the test is finished or stopped.

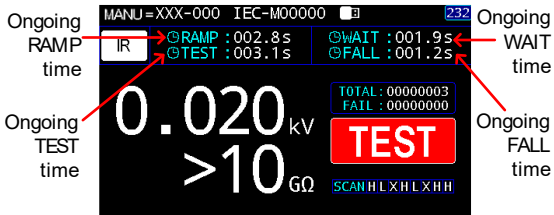

ACW Example

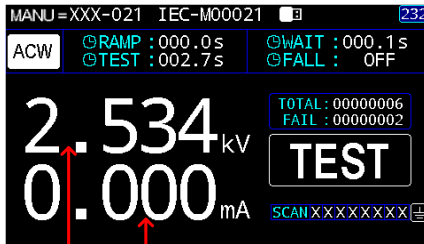

Test Voltage Measured Current

DCW Example

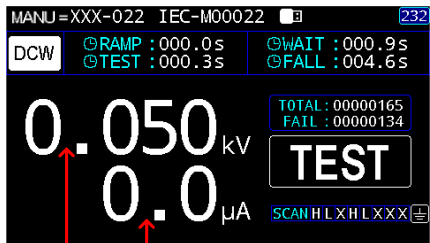

Test Voltage → Measured Current

IR Example

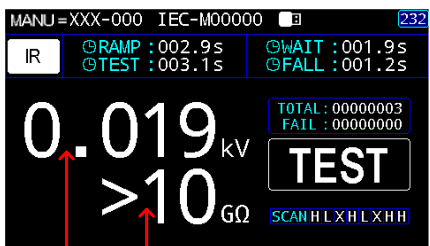

Test Voltage → Measured Resistance



Note

WAIT and FALL time only appear when user has activated them. See page 61 and 48 for details.

Stop the Test

- To stop the test at any time when it is running, press the STOP button. The test will stop immediately. When the STOP button is pressed, a judgment is not made and the STOP status will be shown.

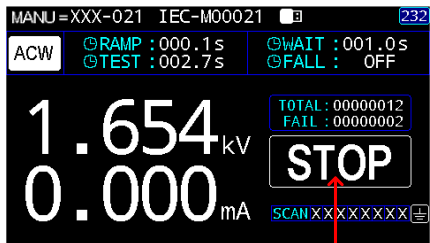
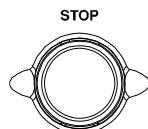

STOP status →

2. Further press the STOP button again to return to the READY status.

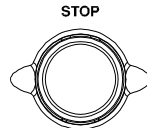

Or press the START button to resume the test.

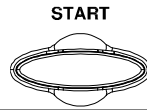

Note

Do not touch any terminals, test leads or any other connections when the test is ongoing.

---

## PASS / FAIL MANU Test

---

### Background

If the test is allowed to run to completion (the test is not stopped or a protection setting is not tripped) then the tester will judge the test as either PASS or FAIL.

---



Note

The test will be judged PASS when:

- The HI SET and LO SET limits have not been tripped during the test time.

The test will be judged FAIL when:

- Either the HI SET or LO SET limit has been tripped during the test time.
  - A protection setting has been tripped during the test time. See page 290 for a list of error messages.
- 

### PASS Judgment

1. When the test is judged as PASS, PASS will be displayed on screen, the buzzer will sound and the PASS indicator will be lit green.

PASS

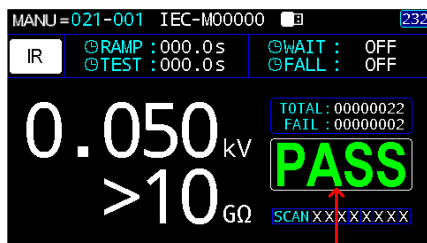

PASS judgment

---

- The tester will immediately restore back to the READY status after PASS judgment. However, if the PASS HOLD is activated, PASS judgment will persist until the set duration of PASS HOLD is fully met. Refer to page 83 for details.

In addition, pressing the STOP button during the set duration of PASS HOLD can return to READY status immediately.

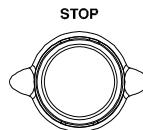

Note

The buzzer will only sound if the Buzzer is set to ON. See page 144 for details.

### PASS Timing Diagrams

The timing diagrams below show the ACW, DCW and IR timing for the START status, TEST status and PASS judgment.

#### ACW PASS Timing

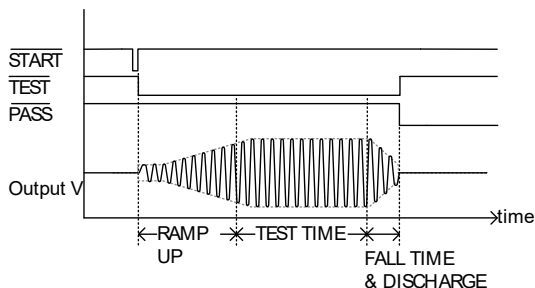

#### DCW PASS Timing

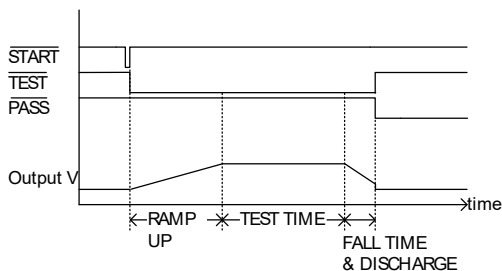

IR PASS Timing

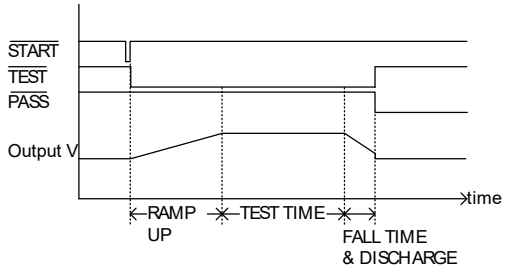

FAIL Judgment

1. When the test is judged as FAIL, FAIL will be displayed on screen, the buzzer will sound and the FAIL indicator will be lit red.

**FAIL**



As soon as a test is judged FAIL, power is cut from the terminals.

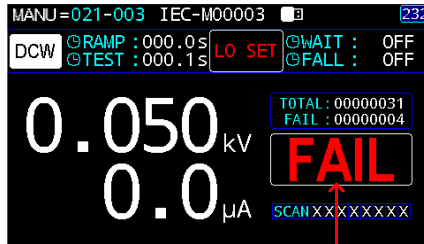

FAIL judgment

2. The FAIL judgment will be held on the display until the STOP button is pressed. Pressing the STOP button will return the tester back to the READY status.

**STOP**

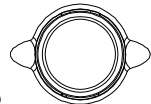

Or press the START button to resume the test.

**START**



Note

The buzzer will only sound if Fail Sound is set to ON. See page 144 for details.

**FAIL Timing Diagrams**

The timing diagrams below show the ACW, DCW and IR timing for the START status, TEST status and FAIL judgment.

**ACW FAIL Timing**

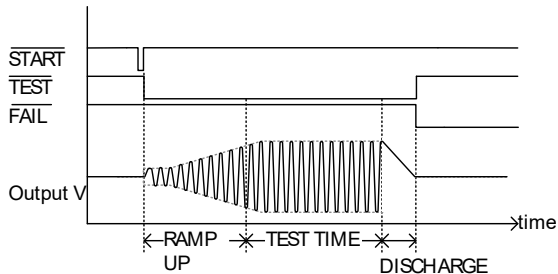

**DCW FAIL Timing**

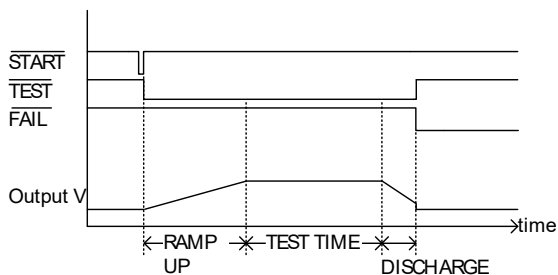

**IR FAIL Timing**

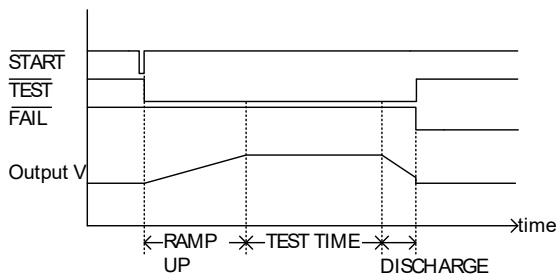

## AUTO Tests



This section describes how to create, edit and run up to 100 automatic tests. An Automatic test allows you to group up to 99 different MANU tests and run them sequentially within a single AUTO test. Each stored MANU test is used as a test step when creating an AUTO test.

- Choose/Recall an AUTO Test → from page 92
- Creating an AUTO Test Name → from page 93
- Adding a MANU Step to the AUTO Test → from page 94
- Viewing and Editing AUTO Group → from page 95
- Setting AUTO Parameters → from page 97
- Getting the Reference Value → from page 111
- Getting the Standard Value → from page 113
- Viewing Steps in AUTO Group → from page 115
- Viewing Parameters Settings of Each Step in List → from page 117
- Page View in AUTO Test → from page 118
- Clear the AUTO tests state → from page 121
- Set a Panel Key Lock → from page 122
- Running an Automatic Test → from page 124
- AUTO Test Results → from page 135

Before operating the GPT-9500 please read the safety precautions as outlined in the Set Up chapter on page 21.

## Choose/Recall an AUTO Test

**Background**                      The tester must first be put into AUTO mode to create or run automatic tests. Up to 100 automatic tests can be saved or recalled.

- Steps**
1. Press the MANU/AUTO soft-key  to select AUTO option.
  2. Use the scroll wheel to select a number of AUTO group. 

AUTO #      000~099



**Note**

The AUTO group number can only be chosen in VIEW status. And the AUTO 000 group is specifically for remote control usage.

**AUTO Group Number Description**

The following “AUTO = 000 (0)” stands for the AUTO group 000 where zero (0) MANU step is added.

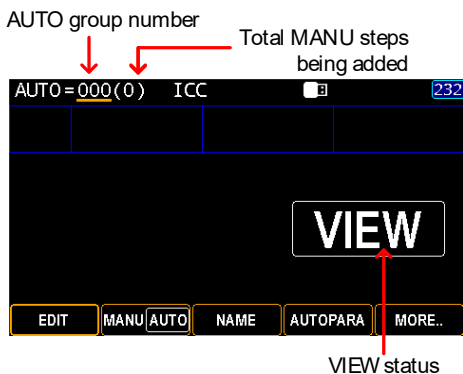



## Creating an AUTO Test Name

---

**Background** Each AUTO test can have a user-defined test name (Default: IEC-A000XX) up to 13 characters long. See the available list of characters below.

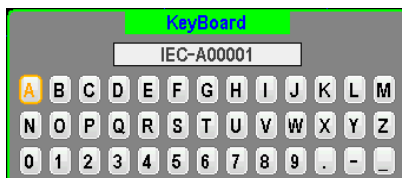
Character List



- Steps**
1. Press the MANU/AUTO soft-key to select AUTO option. 
  2. Press the NAME soft-key to enter the NAME setting. 
  3. The on-screen keyboard is shown where user can input a preferred name for AUTO test. Use the arrow keys or scroll wheel to move among each character and press INPUT soft-key to input character. Press CAPSLOCK soft-key to toggle between high and low case. Press BACKSPACE soft-key to backspace the inputted word. Press EXIT KeyB to exit from the KeyBoard and discard setting.

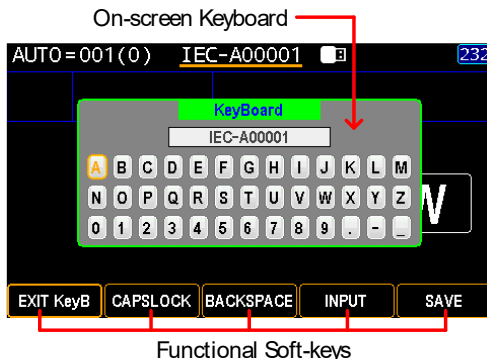

4. Press the SAVE soft-key to confirm the input name.



## Adding a MANU Step to the AUTO Test

**Background** Up to 99 MANU steps can be added to an AUTO test. Each step is added in a sequential order.

- Steps**
1. Press the MANU/AUTO soft-key to select AUTO option.



2. Press the EDIT soft-key.



3. Use the scroll wheel to choose target MANU step(s) to be added to the AUTO test.



MANU STEP number 001~500

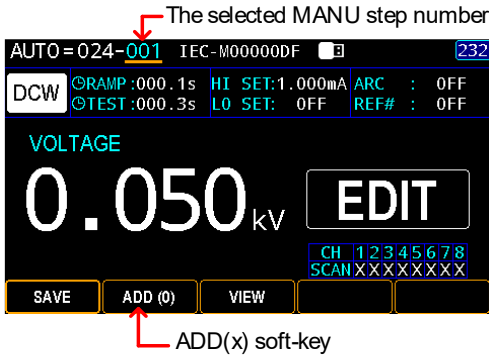

Note

- When MANU step has been added to AUTO group, the number of MANU step turn out bluish and thus will be Not added again.
- MANU number 000 acts like a trial mode in that it could Not be added into AUTO test.

4. Press the ADD(x) soft-key to add the selected MANU step into the AUTO group.



Note

The (x) behind ADD soft-key signifies the total MANU steps being added into the AUTO group.

5. Repeat the previous steps for any other MANU tests that you wish to add to the AUTO test.

## Viewing and Editing AUTO Group

Background

View contents of AUTO group in a table list where user can execute several actions to compose the AUTO group.

Steps

1. Press the MANU/AUTO soft-key to select AUTO option.



- Press the VIEW soft-key to enter the table page.



List of MANU steps of AUTO group

MANU=019(98) IEC-M00005						232
SN	STEP	MODE	VOLT	HI SET	LO SET	SCAN
01	005	DCW	0.050kV	1.000mA	OFF	XXXXXXXXXX
02	016	IR	0.500kV	OFF	050.0MΩ	HXXLXXXX
03	027	IR	0.052kV	OFF	000.1MΩ	XHLXHHXX
04	023	PA	-----	-----	-----	-----
05	024	OSC	0.050kV	STD# =>	008μA	XHXXXXXXXX
06	013	ACW	0.500kV	1.000mA	OFF	HXXLXXXX
07	014	ACW	0.500kV	1.000mA	OFF	XHXLXXXX
08	015	ACW	0.500kV	1.000mA	OFF	XXHLXXXX



Functional Soft-keys

Delete MANU Step

- Use the scroll wheel to move to each MANU step. Press DELETE soft-key to remove MANU step from the table or press DEL ALL to remove the entire MANU steps.



Insert MANU Step

- Use the scroll wheel to move to each MANU step. Press INSERT soft-key to enter the next page.



- From the screen below, use the scroll wheel to move to each MANU step followed by pressing INSERT soft-key to add target MANU step into the AUTO list. Press the RETURN soft-key to discard insert action.



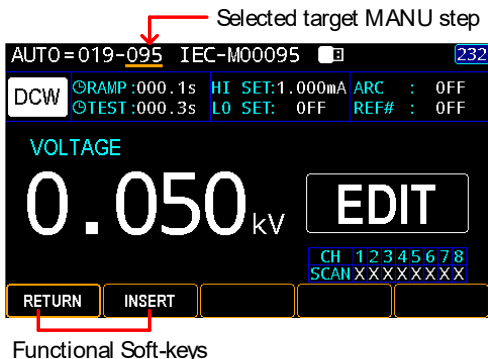



Note

When MANU step has been added to AUTO group, the number of MANU step turn out bluish and thus will be Not added again.

6. Press the EXIT soft-key to leave from the AUTO table list. 

## Setting AUTO Parameters

**Background** This is the parameters setting page specific for AUTO test. It has the higher authority over the parameter settings of each MANU step. Each AUTO group has its own AUTO parameters, which are commonly shared by all MANU steps within the same AUTO group.

- Steps**
1. Press the MANU/AUTO soft-key to select AUTO option. 
  2. Press the AUTOPARA soft-key to enter the AUTO parameters. 

AUTO Parameters  
Settings

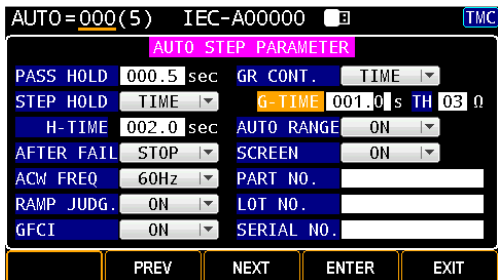

PASS HOLD

Background

The PASS HOLD setting refers to the holding duration after PASS judgment is shown on the display. When the PASS HOLD setting is set, a PASS judgment is held until the set duration is fully reached.

1. Use the PREV & NEXT keys or scroll wheel to move to the PASS HOLD field.



2. Press the ENTER soft-key followed by using the arrow keys and scroll wheel to define a duration.



PASS HOLD      000.2s ~ 999.9s

3. Press the ENTER soft-key to confirm the setting





The STOP key can be pressed at any time in the set duration of PASS HOLD to promptly halt the set PASS HOLD duration.

---

STEP HOLD

**Background**                      The STEP HOLD setting refers to the holding duration after each step within a AUTO group

1. Use the PREV & NEXT keys or scroll wheel to move to the STEP HOLD field.



2. Press the ENTER soft-key followed by using the scroll wheel to select an option. When TIME is selected, define an H-TIME by using the arrow keys and the scroll wheel.



TIME	Step is held until the set duration (H-TIME) is reached. 000.2 ~ 999.9 sec
KEY	Step is held until the START key is pressed.

3. Press the ENTER soft-key to confirm the setting



Note

The STOP key can be pressed at any time in the set duration of STEP HOLD to promptly halt the set STEP HOLD duration.

## AFTER FAIL

## Background

The AFTER FAIL setting refers to the ensuing action after FAIL judgment is shown on the display.

1. Use the PREV & NEXT keys or scroll wheel to move to the AFTER FAIL field.



2. Press the ENTER soft-key followed by using the scroll wheel to select an option.



CONT. Next step keeps going even after FAIL judgment appears.

STOP AUTO test will be stopped immediately after FAIL judgment of one of the steps appears. Only the STOP key can be pressed to return to the READY status.

RESTART AUTO test will be stopped immediately after FAIL judgment of one of the steps appears. User can press START key to restart the AUTO test from the 1<sup>st</sup> step.

3. Press the ENTER soft-key to confirm the setting



AC FREQ

**Background**                      A test frequency of 60Hz or 50Hz can be set, regardless of the input line voltage. The test frequency setting only applies to ACW test.

1. Use the PREV & NEXT keys or scroll wheel to move to the AC FREQ field.



2. Press the ENTER soft-key followed by using the scroll wheel to select an option.



AC FREQ    50Hz, 60Hz

3. Press the ENTER soft-key to confirm the setting



RAMP JUDG.

**Background**                      In theory, neither PASS nor FAIL status is judged during the ramp up time. However, RAMP JUDG. enables judgment during the ramp up duration instead for certain application.

1. Use the PREV & NEXT keys or scroll wheel to move to the RAMP JUDG. field.



2. Press the ENTER soft-key followed by using the scroll wheel to turn ON/OFF the function.

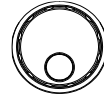

RAMP JUDG.      ON, OFF

3. Press the ENTER soft-key to confirm the setting



GFCI

Background

GFCI, Ground Fail Check Interrupt, function is particularly designed to detect if any electrical leakage or accidental interruption between DUT and GPT-9500. Once issue occurs, output will be stopped and warning message shows accordingly.



Note

To activate GFCI, the GR MODE should be disabled for test. Refer to page 63 for details.

1. Use the PREV & NEXT keys or scroll wheel to move to the GFCI field.



2. Press the ENTER soft-key followed by using the scroll wheel to turn ON/OFF the function.



GFCI                      ON, OFF

3. Press the ENTER soft-key to confirm the setting



GFCI Warning  
Display

GFCI warning message

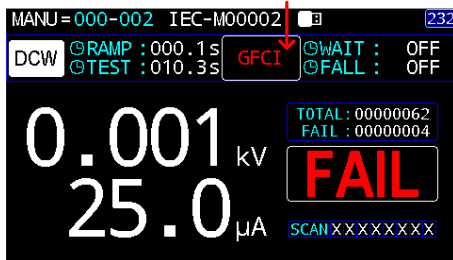

GR CONT.

Background

For some applications, continuity connection is required prior to tests. This section allows user to implement varied methods for continuity test.

 Note

Make sure to connect the specific cord between CONTINUITY terminal and the DUT before executing test with GR CONT. activation.

As the figure shown below, connect the test lead (red) one end to the CONTINUITY terminal and make the red alligator clip on the other end contacted with the DUT.

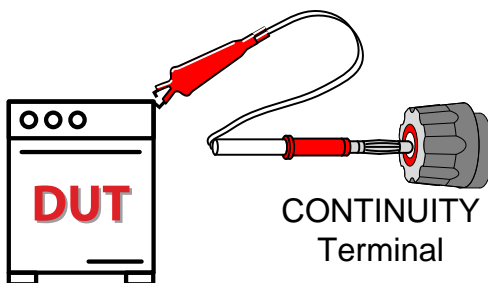

1. Use the PREV & NEXT keys or scroll wheel to move to the GR CONT. field.



2. Press the ENTER soft-key followed by using the scroll wheel to select an option. When TIME is selected, define a G-TIME and TH by using the arrow keys and the scroll wheel.



**KEY** Test cannot be proceeded to until continuity connection is well established.

**TIME** After continuity connection is wired, test will be started after the set time duration (G-TIME from 000.2 ~ 999.9 sec) and the set threshold value (TH from 01 ~ 50 Ω) are reached. Note that the set time will recount if continuity connection is disrupted amid the set time duration.

3. Press the ENTER soft-key to confirm the setting



GR CONT.  
Displays

**KEY**

Test is stopped with GR CONT message

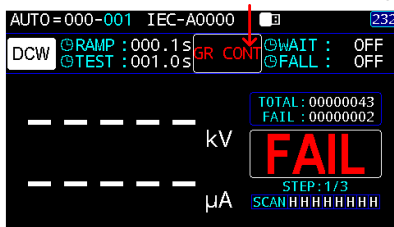

TIME

Test will start after GR wait duration

SN	STEP	MODE	VOLT	HI SET	LO SET	SCAN
00		CONT		30		
01	010	DCW	0.500kV	1.000mA	OFF	XXXXXXXXXX
02	011	DCW	1.000kV	1.000mA	OFF	XXXXXXXXXX
03	012	ACW	0.500kV	1.000mA	OFF	XXXXXXXXXX
04	013	ACW	1.000kV	1.000mA	OFF	XXXXXXXXXX
05	014	IR	0.500kV	OFF	001.0MΩ	XXXXXXXXXX
<b>READY</b>						



**Note**

When all steps of AUTO test are completed, if user intends to redo AUTO test again on the basis of TIME setting of GR CONT., please pull out followed by plugging in the test lead of CONTINUITY terminal so that continuity test will be proceeded properly before all steps of AUTO test.

AUTO RANGE

**Background** For DCW test, the unit for measured current can be determined by user preferences.

 **Note** AUTO RANGE is only applicable to DCW test.

1. Use the PREV & NEXT keys or scroll wheel to move to the AUTO RANGE field.



2. Press the ENTER soft-key followed by using the scroll wheel to turn ON/OFF the function.



- ON The displayed ampere unit is auto-adjustable in light of the measured current.
- OFF The displayed ampere unit is fixed within the unit of mA all the time.

3. Press the ENTER soft-key to confirm the setting



AUTO RANGE Displays

ON

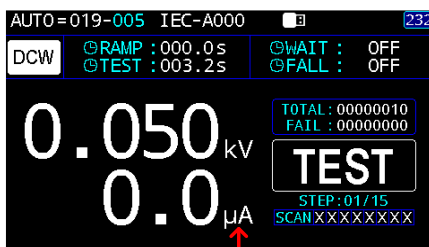

Ampere unit adjusts in accord with measured current

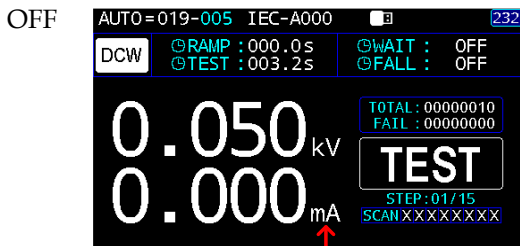

Ampere unit is fixed with the unit of mA

**SCREEN**

**Background** There are up to 3 display modes for READY status and test screen of AUTO test.

1. Use the PREV & NEXT keys or scroll wheel to move to the SCREEN field.



2. Press the ENTER soft-key followed by using the scroll wheel to select an option.



- OFF All the information is hidden from display except for system time.
- ON The entirely full information is shown on display.
- STAT Only TOTAL and FAIL counts with D. RATE (Rate of Distortion) are shown.

3. Press the ENTER soft-key to confirm the setting



SCREEN OFF  
Displays

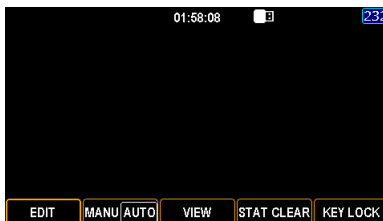

ON

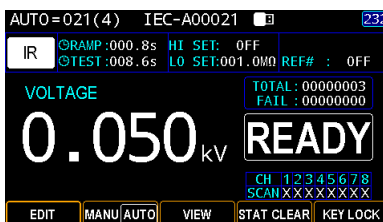

STAT

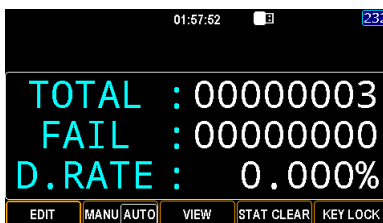

**PART NO., LOT NO. & SERIAL NO.**

Background

It is practical to tab additional info including part, lot and serial numbers for tests on products of batches for easy identification.

1. Use the PREV & NEXT keys or scroll wheel to move to the PART NO., LOT NO. and SERIAL NO. fields, respectively.





2. Press the ENTER soft-key to bring out the on-screen keyboard.

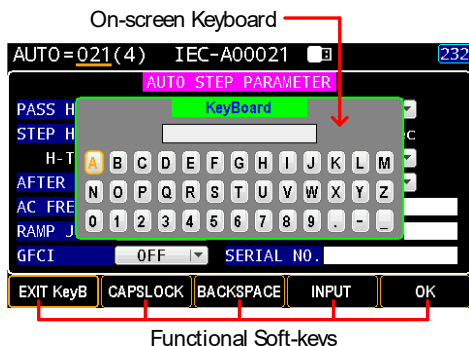

- Use the arrow keys or scroll wheel to move among each character and press INPUT soft-key to input character. Press CAPSLOCK soft-key to toggle between high and low case. Press BACKSPACE soft-key to backspace the inputted word. Press EXIT KeyB to exit from the KeyBoard and discard setting.



- Press the OK soft-key to confirm. 
- Press the SAVE soft-key to finish the AUTOPARA setting. 

PART NO., LOT NO. and SERIAL NO. Display

To see the user-defined No. info, go to the test result display, After AUTO test is finished, and the No. info will be shown in the lower-left corner.

AUTO=021-002 IEC-A00021 232

SN	STEP	MODE	VOLT	CURR/OHM	STATUS	SCAN
01	001	DCW	0.050kV	0.0µA	PASS	XXXXXXXX
02	003	DCW	0.050kV	0.0µA	PASS	HLXXXXXXXX
03	007	DCW	0.050kV	0.0µA	PASS	XXXXXXXX
04	002	OSC	0.047kV	0.000mA	OPEN	XXXXXXXX
05	013	IR	----	----	----	XXXXXXXX
P/N: AA-0166			<b>FAIL</b>			
L/N: B_2						
S/N: BEF.997						

The No. info is superimposed in AUTO test result display



Note

It is available to press the EXIT soft-key anytime to leave the AUTOPARA setting page.

## Getting the Reference Value

### Background

The REF value (REF#) acts as an offset. The REF# is subtracted from the measured current (ACW, DCW) or measured resistance (IR). The GET REF# for AUTO test is particularly convenient in that it helps obtain, with single click, the REF value for each MANU step at one time.

### Steps

1. Press the MANU/AUTO soft-key to select AUTO option.
2. Press the MORE soft-key followed by pressing GET REF# soft-key.



The AUTO group page will be shown where it requests HV output terminal needs to be OPEN prior to pressing START key to get REF#.

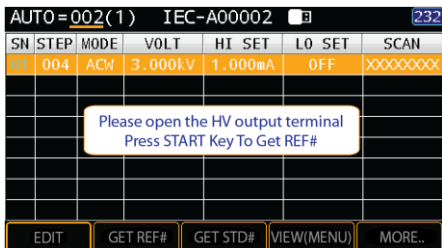

3. After pressing the START key, REF# of each step will be obtained in sequence and the prompt message shows OK.

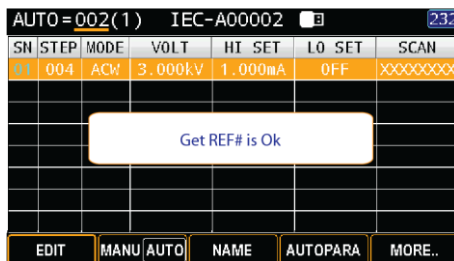
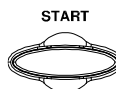

4. Press the ESC key to return to the VIEW status of AUTO group where the REF# will be shown in each MANU step.

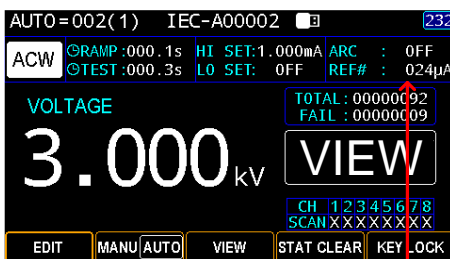

The obtained REF#

 Note

To see REF# of each MANU step, refer to page 115 for details on AUTO step viewing.

Clear the REF#

When it is in VIEW or READY status, press the MANU/AUTO soft-key to select AUTO option.



Press the MORE soft-key followed by pressing CLR REF# soft-key. The REF# will be thus zeroing.

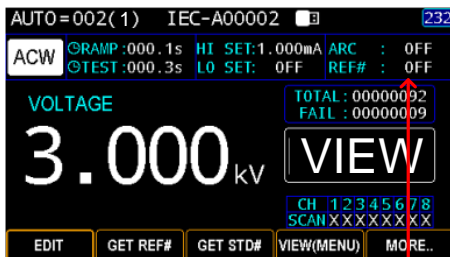

REF# is zeroing in

## Getting the Standard Value

Background

The Standard value (STD#) is a normal value to judge if open or short circuit occurs. It has relation with the Open Short Check (OSC), which is a MANU step used to define thresholds when open or short circuit occurs between the test leads and DUT. The GET STD# for AUTO test is particularly convenient in that it helps obtain, with single click, the STD# value for each OSC step containing multiple channels at one time.

Steps

1. Press the MANU/AUTO soft-key to select AUTO option.



2. Press the MORE soft-key followed by pressing GET STD# soft-key.



The AUTO group page will be shown where it requests GPT-9500 needs to connect to DUT prior to pressing START key to get STD#.

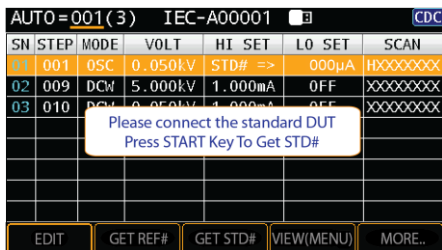

- After pressing the START key, STD# of each OSC step will be obtained in sequence and the prompt message shows OK.

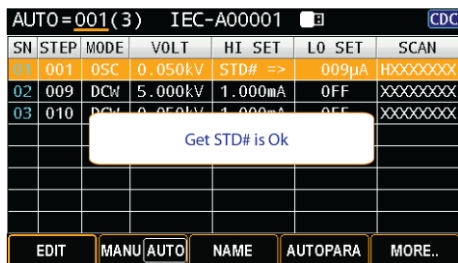
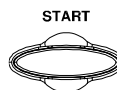

- Press the ESC key to return to the VIEW status of AUTO group where the STD# will be shown in each OSC MANU step.



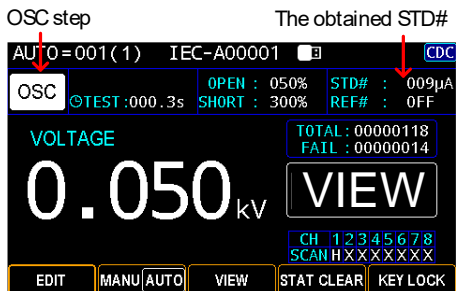





- Refer to page 75 for details on setting open circuit and short circuit thresholds.
- To see STD# of each OSC step, refer to page 115 for details on AUTO step viewing.
- The OSC will be invalid when Standard value (STD#) is defined less than 30uA

## Viewing Steps in AUTO Group

**Background** To check info of each MANU step within the same AUTO group, use the function below.

- Steps**
1. Press the MANU/AUTO soft-key to select AUTO option. 
  2. Press MORE soft-key followed by pressing VIEW (MANU) soft-key.   

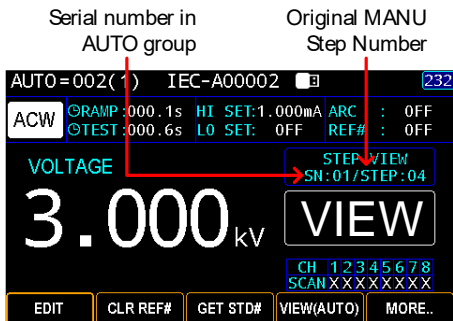
  3. The info box describing the serial number (SN) and the step number (STEP) of each MANU step within the same AUTO group shows in the upper-right corner. Use the scroll wheel to change each step. 



4. Press the VIEW (AUTO) soft-key to exit from the viewing page.



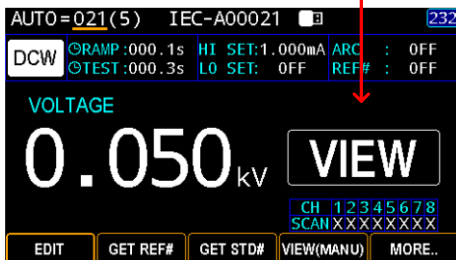

VIEW(AUTO)

MANU step Info box disappears



## Viewing Parameters Settings of Each Step in List

**Background** It is available to see parameters settings of each of step of an AUTO group within a list table.

- Steps**
1. Press the MANU/AUTO soft-key  to select AUTO option.
  2. Use the scroll wheel to go to the target AUTO group. 
  3. Use the PAGE key to enter the list table of target AUTO group where parameters settings of each step are well shown. Further use the scroll wheel to move up and down to the target step for details.  

AUTO=021(5) IEC-A00021  232						
SN	STEP	MODE	VOLT	HI SET	LO SET	SCAN
01	001	DCW	0.068kV	1.000mA	OFF	XXXXXXXX
02	003	DCW	0.050kV	7.606mA	OFF	HLXXXXXXXX
03	007	DCW	0.052kV	1.000mA	OFF	XXXXXXXX
04	002	OSC	0.050kV	STD# =>	000µA	XXXXXXXX
05	013	IR	0.050kV	OFF	001.0MΩ	XXXXXXXX
<div style="display: flex; justify-content: space-between; border: 1px solid black; padding: 2px;"> <span>EDIT</span> <span>MANU/AUTO</span> <span>NAME</span> <span>AUTOPARA</span> <span>MORE..</span> </div>						

## Page View in AUTO Test

**Background** To have overall yet quick glimpse on each step of same AUTO group, use the function below.

**Steps**

1. Make sure the unit is within the READY status under AUTO mode. If it is under VIEW status, press the STOP key to return to the READY status. Alternatively, if it is under the EDIT status, press the SAVE soft-key followed by the STOP key to return to the READY status.

2. Press the PAGE key to enter the AUTO list page.



3. Use the left and right arrow keys to toggle between 2 pages, and utilize the scroll wheel to move among each MANU step.



AUTO steps list – page 1

SN	STEP	MODE	VOLT	HI SET	LO SET	SCAN
01	004	ACW	3.000kV	1.000mA	999µA	XXXXXXXX
02	006	OSC	0.050kV	STD# =>	000µA	XXXXXXXX
03	060	OSC	0.050kV	STD# =>	001µA	XXXXXXXX
<b>READY</b>						

The page 1, in addition to the fixed serial number (SN), MANU step number (STEP) and MODE), includes the set test VOLT, HI & LO SET as well as SCAN deployment.

AUTO steps list – page 2

AUTO = 002(1) IEC-A00002 <span style="float:right">232</span>						
SN	STEP	MODE	VOLT	CURR/OHM	STATUS	SCAN
01	004	ACW	-----	-----	-----	XXXXXXXXXX
02	006	OSC	-----	-----	-----	XXXXXXXXXX
03	060	OSC	-----	-----	-----	XXXXXXXXXX
<b>READY</b>						

The page 2, in addition to the fixed serial number (SN), MANU step number (STEP) and MODE), includes actual test VOLT, measured CURR/OHM, judged STATUS and the actual SCAN judgments of each channel.

Test in Page View

Press the START key in Page View to execute AUTO test directly.

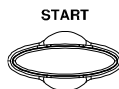

AUTO = 002-150 IEC-A00002 <span style="float:right">232</span>						
SN	STEP	MODE	VOLT	CURR/OHM	STATUS	SCAN
01	004	ACW	2.999kV	0.000mA	PASS	XXXXXXXXXX
02	006	DCW	0.050kV	0.0µA	PASS	XXXXXXXXXX
03	060	OSC	0.047kV	0.006mA	TEST	XXXXXXXXXX
04	025	DCW	-----	-----	-----	XXXXXXXXXX
<b>TEST</b>					TEST TIME:	000.1s

Test being executed for each step in sequence

TEST starts with time counting

Test Result in Page View

In addition to the final judgment in the bottom line, the judged status of each step is clearly shown.

AUTO=002-125 IEC-A00002 232						
SN	STEP	MODE	VOLT	CURR/OHM	STATUS	SCAN
01	004	ACW	2.999kV	0.000mA	PASS	XXXXXXXX
02	006	DCW	0.050kV	0.0μA	PASS	XXXXXXXX
03	060	OSC	0.047kV	0.006mA	PASS	XXXXXXXX
04	025	DCW	0.050kV	0.0μA	LO SET	XXXXXXXX
					<b>FAIL</b>	

The final judgment      Judgments of each step

Exit the Page View

Press the ESC key to return to the READY status of AUTO test.



## Clear the tests state

**Background** The test state covering TOTAL test counts and judgments of FAIL is clearly shown on the READY status of either MANU or AUTO test. To erase the records, follow the steps below.

- Steps**
1. Make sure the unit is within the READY status. If it is under VIEW status, press the STOP key to return to the READY status. Alternatively, if it is under the EDIT status, press the SAVE soft-key followed by the STOP key to return to the READY status.

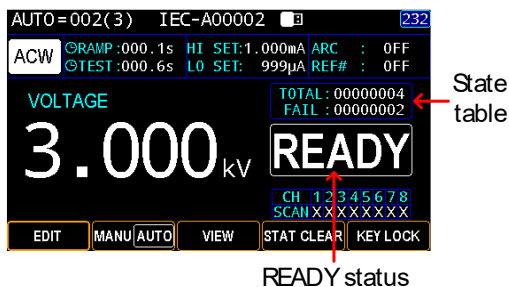

TOTAL The total test counts  
 FAIL The total FAIL judgments

2. Press and hold the STAT CLEAR  soft-key for 1 second.

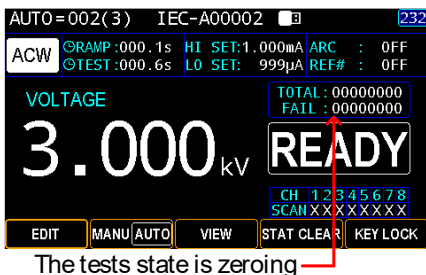

The tests state is zeroing

## Set a Panel Key Lock

**Background** Key Lock disables the front panel keys from changing the test number, mode or testing parameters. Only the START & STOP buttons required for testing are not disabled. Also, the KEY LOCK soft-key remains functional for user to unlock the function.

- Steps**
1. Make sure the unit is within the READY status under AUTO mode. If it is under VIEW status, press the STOP key to return to the READY status. Alternatively, if it is under the EDIT status, press the SAVE soft-key followed by the STOP key to return to the READY status.

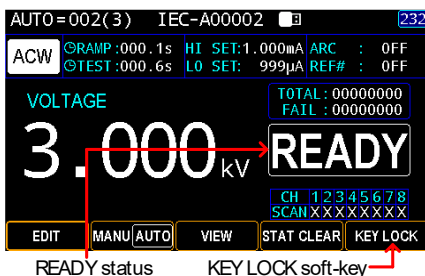

2. Press and hold the KEY LOCK soft-key for 1 second.

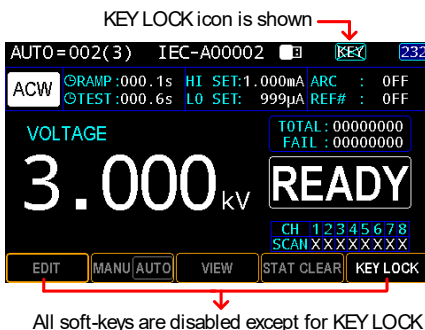

- Unlock Key Lock 3. Again, press and hold the KEY LOCK soft-key for 1 second.

KEY LOCK

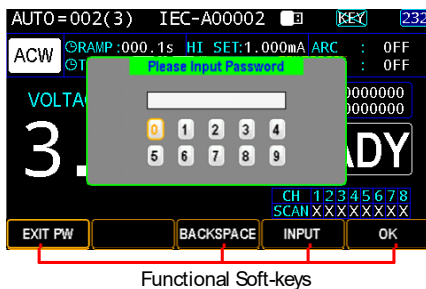

4. The on-screen keyboard is shown where user can input password to unlock the key lock. Use the scroll wheel to move among each number and press INPUT soft-key to input number. Press BACKSPACE soft-key to backspace the inputted word. Press EXIT PW to exit from the KeyBoard and discard setting.
5. Press the OK soft-key to unlock the KEY LOCK function.

OK

## Running an Automatic Test

**Background** An automatic test can be run when the tester is in READY status.



Note

The tester cannot start to run an AUTO test under the following conditions:

- Any protection modes have been tripped.
- The INTERLOCK function is ON and the Interlock wire is not shorted in the Interlock terminal (page 203).
- The STOP signal has been received remotely.
- If Double Action is ON, ensure the START button is pressed immediately after the STOP button (<0.5s).



Warning

Do not touch any terminals, test leads or the DUT when a test is running.

- Steps**
1. Ensure tester is in READY status for the AUTO test to come. If it is under VIEW status, press the STOP key to return to the READY status.

**Normal AUTO Display**

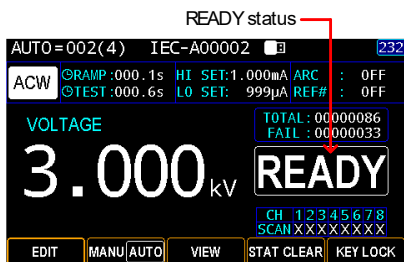

AUTO Page View Display

SN	STEP	MODE	VOLT	HI SET	LO SET	SCAN
01	004	ACW	3.000kV	1.000mA	999µA	XXXXXXXX
02	006	DCW	0.050kV	1.000mA	0FF	XXXXXXXX
03	060	OSC	0.050kV	STD# =>	001µA	XXXXXXXX
04	025	DCW	0.050kV	1.000mA	999µA	XXXXXXXX
<b>READY</b>						

READY status

2. Press the START button when the tester is in the READY status. The AUTO test starts automatically and the display changes to each MANU step in sequence.

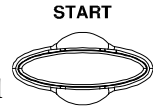

3. Each MANU step will start by showing the ongoing RAMP time followed by the ongoing TEST time and the ongoing WAIT time and finally the ongoing FALL time. All steps will be tested in sequence until the last test has finished or the test is stopped.

Normal AUTO Display

Several ongoing durations

The screenshot shows the following information:

- Mode: ACW
- Parameters: RAMP : 002.9s, TEST : 005.8s, WAIT : OFF, FALL : OFF
- Real-time values: 0.778 kV, 0.000 mA
- Summary: TOTAL : 00000126, FAIL : 00000053
- Step indicator: **TEST** (red box), STEP : 1/4
- Scan status: SCANXXXXXXXX

TEST is ongoing

The step being underway

AUTO Page View  
Display

The step being underway

SN	STEP	MODE	VOLT	CURR/OHM	STATUS	SCAN
01	004	ACW	0.778kV	0.000mA	TEST	XXXXXXXX
02	006	DCW	-----	-----	-----	XXXXXXXX
03	060	OSC	-----	-----	-----	XXXXXXXX
04	025	DCW	-----	-----	-----	XXXXXXXX
					<b>TEST</b>	RAMP TIME: 002.9s

TEST is ongoing                      Several ongoing durations



WAIT and FALL time only appear when user has activated them. See page 59 and page 61 for details.

PASS HOLD

1. If Pass Hold is set for an AUTO test, then the tester will hold for the set duration when PASS judgment for the entire steps occurs. See page 98 for more details.

Normal  
AUTO  
Display  
for PASS  
HOLD

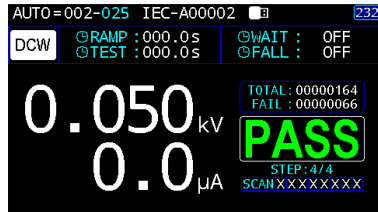

AUTO  
Page  
View  
Display  
for PASS  
HOLD

SN	STEP	MODE	VOLT	CURR/OHM	STATUS	SCAN
01	004	ACV	2.998kV	0.000mA	PASS	XXXXXXXXXX
02	006	DCV	0.050kV	0.0μA	PASS	XXXXXXXXXX
03	060	OSC	0.050kV	0.007mA	PASS	XXXXXXXXXX
04	025	DCV	0.050kV	0.0μA	PASS	XXXXXXXXXX
<b>PASS</b>						

2. The PASS indicator on the front panel will also be lit. The buzzer will sound when activated.
3. To repeat the AUTO test again, press the START button.
4. To exit from the PASS HOLD status, press the STOP button.

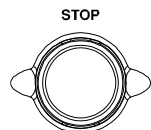
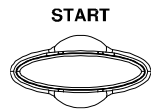

Note

When in the PASSHOLD status, only the START and STOP buttons can be pressed, all other keys are disabled.

STEP HOLD

1. If Step Hold is set for an AUTO test, then the tester will hold for each step, whether it is PASS or FAIL judgment, either for WAIT KEY or for HOLD TIME action. See page 100 for more details.

Normal  
AUTO  
Display  
for  
WAIT  
KEY



AUTO  
Page  
View  
Display  
for  
WAIT  
KEY

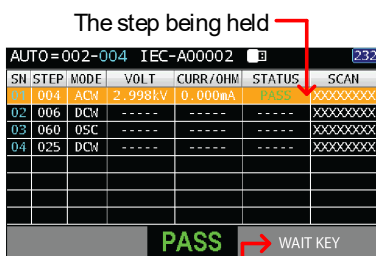

Normal  
AUTO  
Display  
for  
HOLD  
TIME

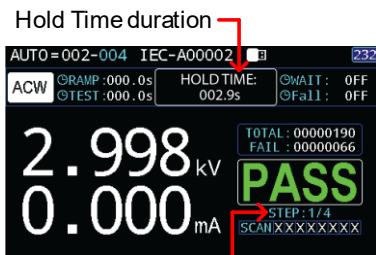

AUTO  
Page  
View  
Display  
for  
HOLD  
TIME

The step being held

SN	STEP	MODE	VOLT	CURR/OHM	STATUS	SCAN
01	004	ACW	2.998kV	0.000mA	PASS	XXXXXXXXXX
02	006	DCW	-----	-----	-----	XXXXXXXXXX
03	060	OSC	-----	-----	-----	XXXXXXXXXX
04	025	DCW	-----	-----	-----	XXXXXXXXXX

Hold Time duration

2. The PASS or FAIL indicator on the front panel will also be lit. The buzzer will sound when activated.



3. To repeat the AUTO test again, press the START button.

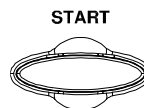

4. To exit from the PASS HOLD status, press the STOP button.

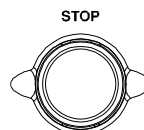

 Note

- When it is in STEP HOLD status, only the START and STOP buttons can be pressed, all other keys are disabled.
- If AFTER FAIL STOP is enabled, the STEP HOLD action will be discarded when FAIL judgment occurs.

- AFTER FAIL STOP 1. If After Fail Stop is set for an AUTO test, then the tester will stop the whole AUTO test immediately when a FAIL judgment of anyone of the steps occurs. See page 101 for more details.

Normal  
AUTO  
Display  
for  
AFTER  
FAIL  
STOP

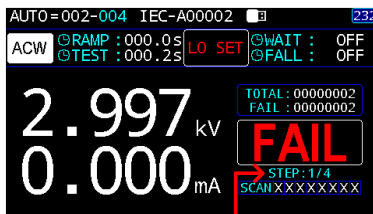

AUTO test stops in the 1st step immediately

AUTO  
Page  
View  
Display  
for  
AFTER  
FAIL  
STOP

SN	STEP	MODE	VOLT	CURR/OHM	STATUS	SCAN
01	004	ACW	2.997kV	0.000mA	LO SET	XXXXXXXXXX
02	006	DCW	----	----	----	XXXXXXXXXX
03	060	OSC	----	----	----	XXXXXXXXXX
04	025	DCW	----	----	----	XXXXXXXXXX

AUTO test stops in the 1st step immediately

2. The FAIL indicator on the front panel will also be lit. The buzzer will sound when activated.
3. When FAIL is displayed on-screen, press the STOP button to return to the READY status.

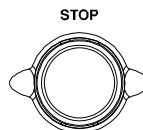

When AFTER FAIL STOP occurs, only the STOP button can be pressed, all other keys are disabled.

**AFTER FAIL  
RESTART**

1. If After Fail Restart is set for an AUTO test, then the tester will stop the whole AUTO test immediately when a FAIL judgment of anyone of the MANU steps occurs. And it is available to press the START key to restart the AUTO test. See page 101 for more details.

Normal  
AUTO  
Display  
for AFTER  
FAIL  
RESTART

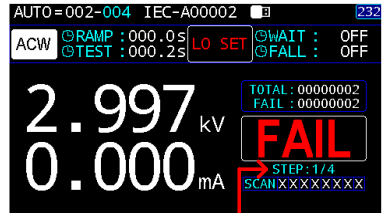

AUTO test stops in the 1st step immediately

AUTO  
Page View  
Display  
for  
AFTER  
FAIL  
RESTART

AUTO=002-004 IEC-A00002 232

SN	STEP	MODE	VOLT	CURR/OHM	STATUS	SCAN
01	004	ACM	2.997kV	0.000mA	LO SET	XXXXXXXXXX
02	006	DCM	----	----	----	XXXXXXXXXX
03	060	OSC	----	----	----	XXXXXXXXXX
04	025	DCM	----	----	----	XXXXXXXXXX

FAIL

AUTO test stops in the 1st step immediately

2. The FAIL indicator on the front panel will also be lit. The buzzer will sound when activated.



3. When FAIL is displayed on-screen, press the STOP button to return to the READY status or press the START key to restart the AUTO test.

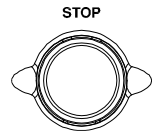

When AFTER FAIL RESTART occurs, only the START and STOP buttons can be pressed, all other keys are disabled.

- Stop a Test
- Running 1. To stop the AUTO test at any time when it is running, press the STOP button. The AUTO test will stop immediately. When the STOP button is pressed, a judgment is not made on the current test and any remaining tests are aborted.

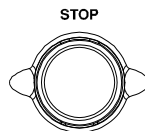

All panel keys except the STOP and START buttons are disabled when the tester has been stopped. All the results up until when the AUTO test was stopped are shown on-screen. See page 135 for more details on automatic test results.

Below is example of an automatic test that has been stopped in the midway. The remaining MANU steps are aborted without test results.





## AUTO Test Results

**Background** If all the test steps are allowed to run to completion (the AUTO test is not stopped or a protection setting is not tripped) then the tester will judge each step as either PASS or FAIL. This is shown as a table after the AUTO test has finished running. If the test has been stopped, then any remaining tests will not be run and thus the AUTO test will not finish running.

**Overview** Test Result of Normal AUTO Display

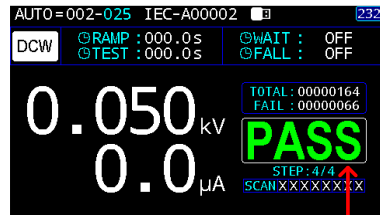

AUTO test result indicator

**Test Result of AUTO Page View Display**

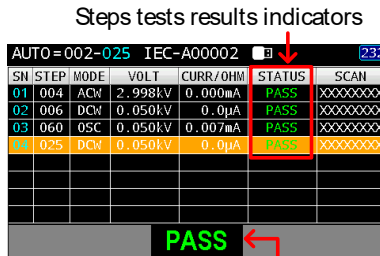

Steps tests results indicators

AUTO test result indicator

 **Note**

The PASS/FAIL/STOP result shown for an AUTO test as a whole depends on the results of all the steps (MANU steps) that compose an AUTO test. If Interlock function is enabled but without interlock wire shorted into Interlock terminal, the Interlock Open message will be shown and AUTO test will be unable to start. Refer to page 164 for details.

**PASS Result**

Each MANU step must be passed to present a PASS judgment on an AUTO test. When all the tests have been judged as PASS, the PASS indicator will be lit green and the buzzer will sound if activated.

**PASS**



PASS Judgment of Normal AUTO Display

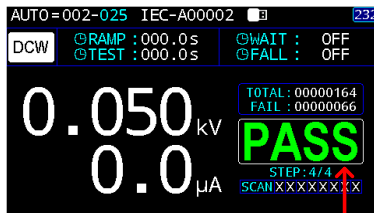

AUTO test PASS judgment

PASS Judgment of AUTO Page View Display

All steps with PASS judgments

SN	STEP	MODE	VOLT	CURR/OHM	STATUS	SCAN
01	004	ACW	2.998kV	0.000mA	PASS	XXXXXXXXXX
02	006	DCW	0.050kV	0.0μA	PASS	XXXXXXXXXX
03	060	OSC	0.050kV	0.007mA	PASS	XXXXXXXXXX
04	025	DCW	0.050kV	0.0μA	PASS	XXXXXXXXXX
					<b>PASS</b>	

AUTO test PASS judgment



Note

The Buzzer setting must to set to ON for the beeper to sound (page 144).

**FAIL Result**

A FAIL result from a single MANU step will result in FAIL judgment for the whole AUTO test.

**FAIL**



When any of the tests have been judged as FAIL, the FAIL indicator will be lit red and the buzzer will sound if activated.

**FAIL Judgment of Normal AUTO Display**

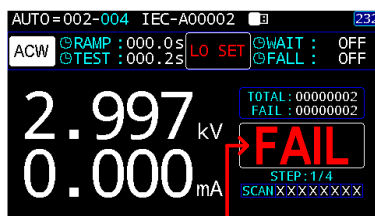

AUTO test FAIL judgment

**FAIL Judgment of AUTO Page View Display**

One of steps with FAIL judgment

SN	STEP	MODE	VOLT	CURR/OHM	STATUS	SCAN
01	004	ACW	2.999kV	0.000mA	PASS	XXXXXXXXXX
02	006	DCW	0.050kV	0.0μA	PASS	XXXXXXXXXX
03	060	OSC	0.047kV	0.006mA	PASS	XXXXXXXXXX
04	025	DCW	0.050kV	0.0μA	LO SET	XXXXXXXXXX

AUTO test FAIL judgment



**Note**

The Buzzer setting must to set to ON for the beeper to sound (page 144).

STOP Result

Once a step is stopped, the AUTO test will be presented STOP in its result. In other words, if a MANU step is stopped, the entire AUTO test turns out STOP status, neither PASS nor FAIL judgment. And the remaining MANU step(s) will be ignored with blank in test result field.

STOP  
Result of  
AUTO  
Page View  
Display

One of steps is stopped

SN	STEP	MODE	VOLT	CURR/OHM	STATUS	SCAN
01	004	ACH	2.997kV	0.000mA	LO SET	XXXXXXXX
02	006	DCW	0.050kV	0.0µA	STOP	XXXXXXXX
03	060	OSC	-----	-----	-----	XXXXXXXX
04	025	DCW	-----	-----	-----	XXXXXXXX

**STOP**

AUTO test STOP result

STOP  
Result of  
Normal  
AUTO  
Display

AUTO test STOP result

DCW		ⓄRAMP : 000.0S	ⓄWAIT : OFF
		ⓄTEST : 000.1S	ⓄFALL : OFF
0.050 kV		TOTAL : 0000048	
0.0 µA		FAIL : 0000019	
		<b>STOP</b>	
		STEP: 1/4	
		SCANXXXXXXXXXX	

The exact stopped step (1/4)



Note

The Buzzer setting must to set to ON for the beeper to sound (page 144).



Return to Status Ready 1. The PASS/FAIL/STOP results will be held on the screen until the STOP button is pressed.



Note

PASS HOLD will return to READY status automatically after the set duration (page 98).

2. To put the tester back into READY status, press the STOP button.

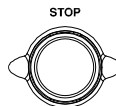

3. The READY indicator will be shown on the display.

AUTO  
Page View  
Display  
for  
READY  
Status



Return to READY status

Normal  
AUTO  
Display  
for  
READY  
Status

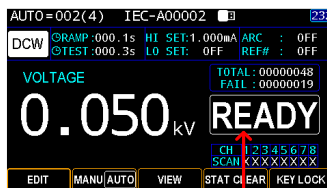

Return to READY status

PASS Timing  
Diagram

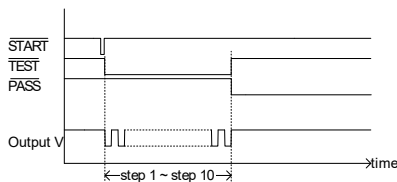

FAIL Timing  
Diagram

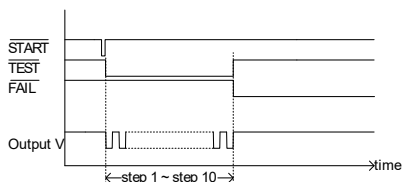

# UTILITY

---

<b>System Setting</b> .....	<b>143</b>
Backlight Setting .....	143
Beep Setting .....	144
Key Sound Setting .....	145
Date Setting .....	146
Time Setting.....	147
Copy To USB Setting .....	148
Copy From USB Setting .....	149
Calibration Setting .....	150
Calibration Alert Setting .....	151
Firmware Setting.....	158
Security Setting.....	159
Language Setting.....	161
System Info Setting .....	162
<b>Test Setting</b> .....	<b>163</b>
Control Setting.....	163
InterLock Setting.....	164
PowerGND Check Setting.....	166
Wait Time Mode Setting.....	168
ARC Mode Setting .....	170
Safety Display Setting .....	172
Double Action Setting .....	174
Start Click (1 Sec) Setting .....	176
ACW Frequency Setting (for MANU).....	178
Pass Hold Setting (for MANU) .....	179
GFCI Setting (for MANU).....	181

Auto Range Setting (for MANU) .....	183
Screen Setting (for MANU) .....	185
Ramp Judg Setting (for MANU) .....	187
Step By Step (Scan) Setting (for MANU) .....	188
<b>Interface Setting.....</b>	<b>190</b>
Interface Setting .....	190
Baud Rate Setting.....	191
Parity Setting .....	193
End Of Line Setting.....	194
SCPI ID Identity Setting.....	195
Auto Save (PARA) Setting.....	197

# System Setting

## Backlight Setting

Description Backlight brightness adjustment

Steps

1. Press the UTILITY key on the front panel followed by pressing the ENTER soft-key to enter the field.

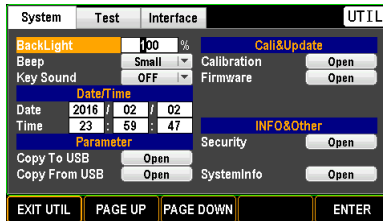

2. Use the arrow keys to move the cursor and use the scroll wheel to define target backlight level.

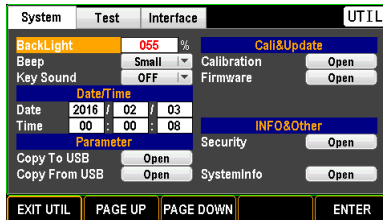
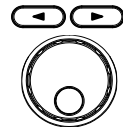

BackLight 5% (low) ~ 100% (high)

3. Press the ENTER soft-key to confirm the setting.



## Beep Setting

**Description** Use beep settings to set whether the beep will sound for PASS/FAIL judgments.

- Steps**
1. Press the UTILITY key on the front panel followed by using the scroll wheel to move to the Beep. Press the ENTER soft-key to enter the Beep field.

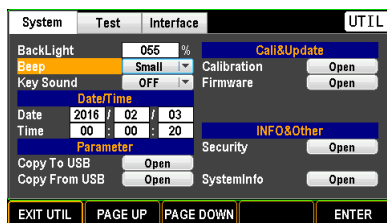

2. Use the scroll wheel to select an option for Beep sound level.

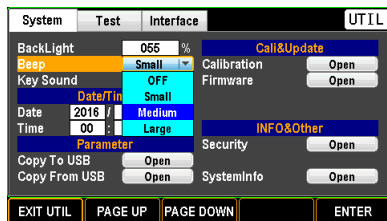

Beep OFF, Small, Medium, Large

3. Press the ENTER soft-key to confirm the setting.



When in the AUTO test, the Beep sound only applies to the final judgment of an AUTO test instead of for judgment of each test step.

## Key Sound Setting

Description Enable or Disable Key Sound.

Steps

1. Press the UTILITY key on the front panel followed by using the scroll wheel to move to the Key Sound. Press the ENTER soft-key to enter the Key Sound field.

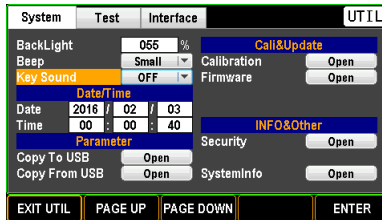

2. Use the scroll wheel to turn ON/OFF the Key Sound setting.

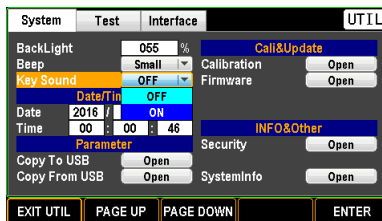

Key Sound OFF, ON

3. Press the ENTER soft-key to confirm the setting.



## Date Setting

**Description** Manually adjust date for system.

**Steps**

1. Press the UTILITY key on the front panel followed by using the scroll wheel to move to the Date. Press the ENTER soft-key to enter the Date field (YYYY - year).

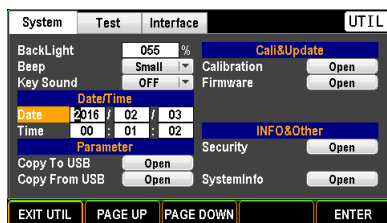

2. Use the arrow keys to move the cursor and use the scroll wheel to define target year.

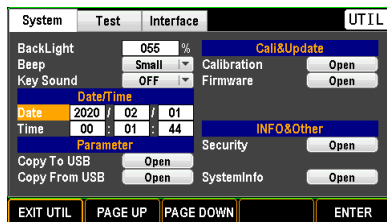
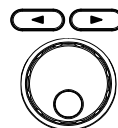

3. Press the ENTER soft-key to confirm the setting.
4. Repeat the above steps to further set up (MM - month) and (DD - date) fields, individually.



## Time Setting

Description Manually adjust time for system.

Steps

1. Press the UTILITY key on the front panel followed by using the scroll wheel to move to the Time. Press the ENTER soft-key to enter the Time field (HH - hour).

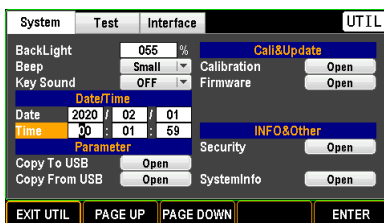

2. Use the arrow keys to move the cursor and use the scroll wheel to define target hour.

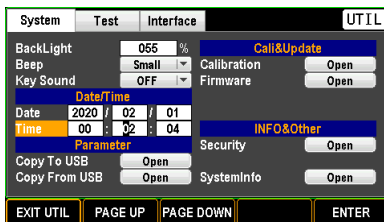
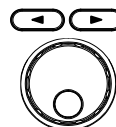

3. Press the ENTER soft-key to confirm the setting.



4. Repeat the above steps to further set up (MM - minute) and (SS - second) fields, individually.

## Copy To USB Setting

**Description** Copy the parameters settings from GPT-9500 to the connected USB. It is noted that only USB1.1 or 2.0, FAT16 or FAT32, capacity <= 64G can support this function.

- Steps**
1. Press the UTILITY key on the front panel followed by using the scroll wheel to move to the Copy To USB. Press the ENTER soft-key to enter the Copy To USB field.

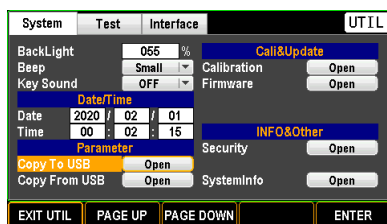

2. Use the arrow keys or scroll wheel to move among each character and press INPUT soft-key to input target characters.

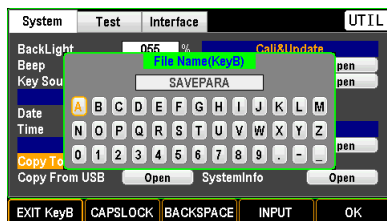

3. Press the OK soft-key to confirm the setting.



## Copy From USB Setting

**Description** Copy the parameters settings from the connected USB to GPT-9500. It is noted that only USB1.1 or 2.0, FAT16 or FAT32, capacity <= 64G can support this function.

- Steps**
1. Press the UTILITY key on the front panel followed by using the scroll wheel to move to the Copy From USB. Press the ENTER soft-key to enter the Copy From USB field.

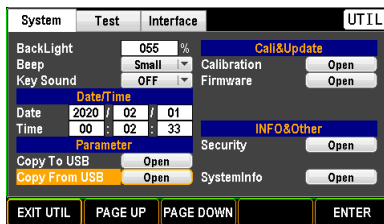

2. Use the scroll wheel to move to target .SAV file within the USB followed by pressing OK soft-key to proceed to the next step.

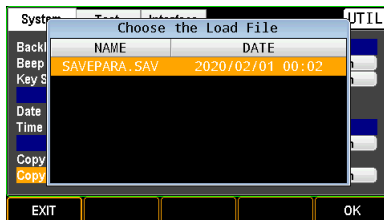

3. Use the scroll wheel to move to each check box followed by pressing the PAGE key to check/uncheck each parameter.



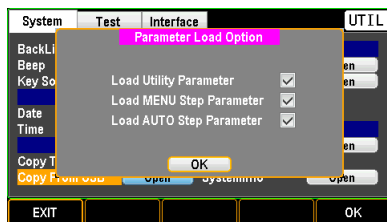

4. Press the OK soft-key to confirm the setting.



## Calibration Setting

**Description** This section mainly provides several calibration methods. **Note that only the certified technician can operate the calibration procedure. Refer to the service manual for details when necessary.**

1. Press the UTILITY key on the front panel followed by using the scroll wheel to move to the Calibration. Press the ENTER soft-key to enter the Calibration field.

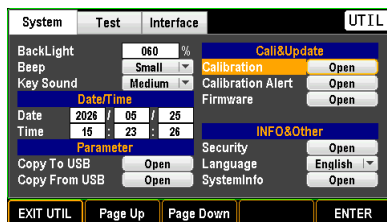

2. Use the arrow keys or scroll wheel to move among each character and press the INPUT soft-key to input target password.



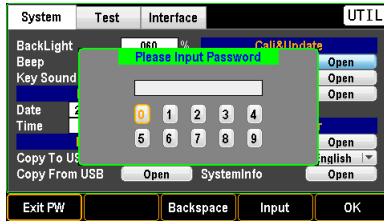

3. Refer to certified technician and the service manual for more details on calibration procedure.

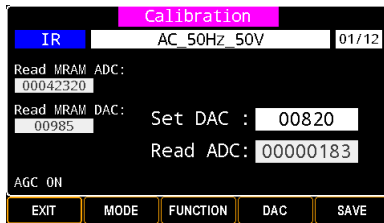

4. Press the OK soft-key to confirm the setting.

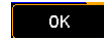

## Calibration Alert Setting

**Description** This section offers the settings of alert function, protection function, among others for calibration.

- Steps**
1. Press the UTILITY key on the front panel followed by using the scroll wheel to move to the Calibration Alert. Press the ENTER soft-key to enter the Calibration Alert field.



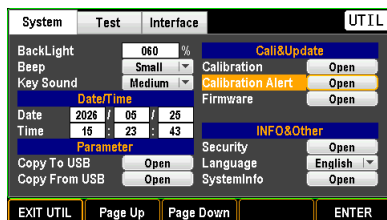

- Use the scroll wheel to move to the Calibration Alert followed by pressing the ENTER soft-key to enter the Calibration Alert field.

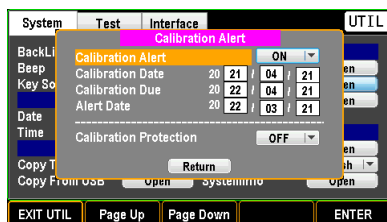

- Use the scroll wheel to turn ON/OFF the Calibration Alert, which activates alert function of calibration for user.

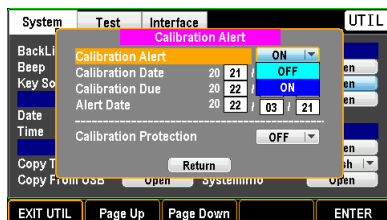

- Press the OK soft-key to confirm the setting.



- Use the scroll wheel to move to the Calibration Date field. Press the ENTER soft-key to enter the Calibration Date field.

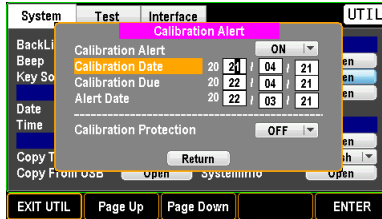

- Use the arrow keys to move the cursor and use the scroll wheel to define target year (YY - 20XX).

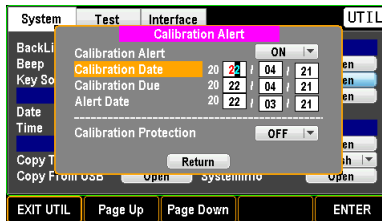

- Press the ENTER soft-key to confirm the setting.



- Repeat the above steps to further set up MM (month) and DD (date) fields, individually, for Calibration Date, which defines a specific date of calibration based on the date when the calibration of GPT-9500 is completed.

- Use the scroll wheel to move to the Calibration Due field. Press the ENTER soft-key to enter the Calibration Due field.

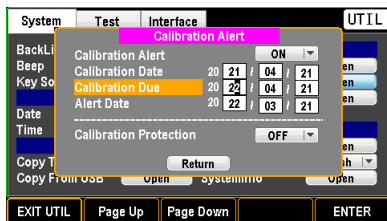

- Use the arrow keys to move the cursor and use the scroll wheel to define target year (YY - 20XX).

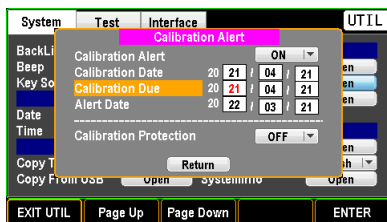
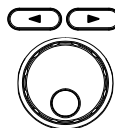

- Press the ENTER soft-key to confirm the setting.



- Repeat the above steps to further set up MM (month) and DD (date) fields, individually, for Calibration Due, which defines a specific due date of calibration (12 months after set calibration date, by default) for GPT-9500 unit.



Note

When the set due date is reached, the prompt message appears upon startup. Please have qualified technician perform calibration ASAP.

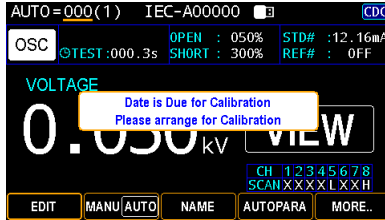

13. Use the scroll wheel to move to the Alert Date field. Press the ENTER soft-key to enter the Alert Date field.



ENTER

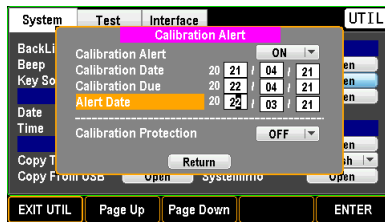

14. Use the arrow keys to move the cursor and use the scroll wheel to define target year (YY - 20XX).

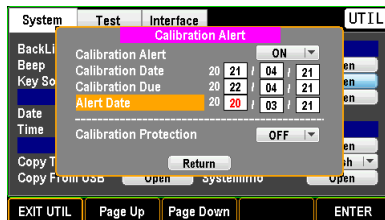
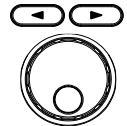

15. Press the ENTER soft-key to confirm the setting.

ENTER

- Repeat the above steps to further set up MM (month) and DD (date) fields, individually, for Alert Date, which defines a specific alert date of calibration (one month prior to set calibration due date, by default) for GPT-9500 unit.



Note

When the set alert date is reached, the prompt message appears upon startup. Please have qualified technician prearrange calibration at the earliest possible time.



- Use the scroll wheel to move to the Calibration Protection filed followed by pressing the ENTER soft-key to enter the Calibration Protection filed.

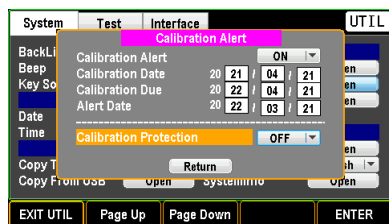
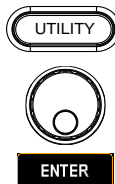

- Use the scroll wheel to turn ON/OFF the Calibration Protection, which forces the output function of GPT-9500 to become out of service when the calibration due date is met.



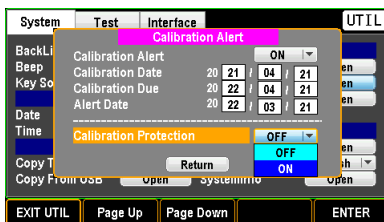

19. Press the OK soft-key to confirm the setting.



When the calibration protection is On and the set due date is reached, the prompt message appears upon startup. And the red highlight in the upper status bar signals that output function of GPT-9500 is off-limits for user. Please have qualified technician perform calibration ASAP.

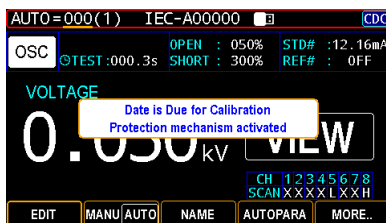

## Firmware Setting

**Description** This section is for updating the latest firmware.

- Steps**
1. Press the UTILITY key on the front panel followed by using the scroll wheel to move to the Firmware. Press the ENTER soft-key to enter the Firmware field.

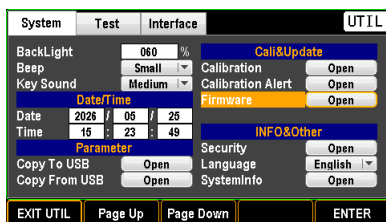

2. Press the ENTER soft-key to Check USB Files (Step 1) and the qualified firmware version will be shown with OK message.



Prior to update, make sure if the required firmware file (IMAGE.BIN) is stored within the plugged USB. If the firmware file is with name other than IMAGE.BIN, the file could Not be recognized by the unit properly.

- Use the scroll wheel to move to the Update followed by pressing the ENTER soft-key to Start Update.



ENTER

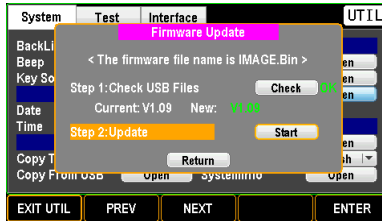

## Security Setting

Description

This section is to change the password and enable or disable Key Lock password.

Steps

- Press the UTILITY key on the front panel followed by using the scroll wheel to move to the Security. Press the ENTER soft-key to enter the Security field.



ENTER

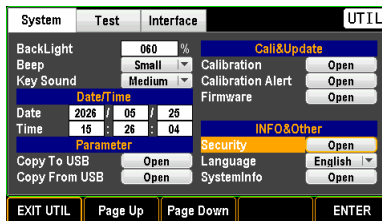

- Use the arrow keys or scroll wheel to move among each character and press the INPUT soft-key to input target password.



INPUT

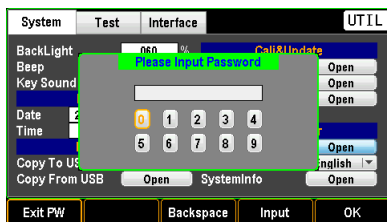

Default Password 12345678

- Use the Page key to check/uncheck KeyLock Password Enable function.



- Use the scroll wheel to move to the Old Password field to input the old password followed by inputting new password twice in the following 2 fields respectively. Finally, press the ENTER soft-key to Start changing to the new password.



For details of Key Lock, refer to page 81.

## Language Setting

Description Select language for user interface display.

Steps

1. Press the UTILITY key on the front panel followed by using the scroll wheel to move to the Language field.

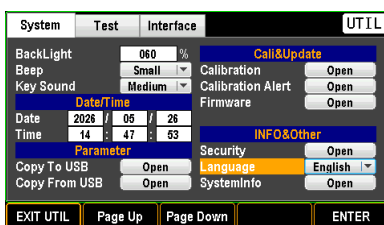

2. Press the ENTER soft-key to enter the Language field.

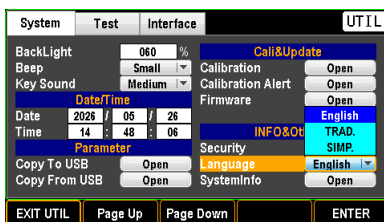

3. Use the scroll wheel to select among different languages for UI.



4. Press the OK soft-key to confirm the setting.



## System Info Setting

**Description** View system information including Vendor, Model Name, Serial Number and Firmware.

- Steps**
1. Press the UTILITY key on the front panel followed by using the scroll wheel to move to the SystemInfo.

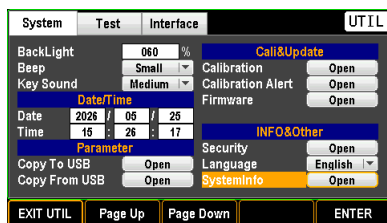

2. Press the ENTER soft-key to enter the SystemInfo field.

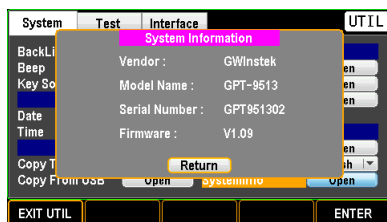

3. Press the ENTER soft-key to Return to the System main page.



# Test Setting

## Control Setting

**Description** Control By is used to determine how a test is started from the front panel (START/STOP keys) or from a SIGNAL I/O port or from both methods.

- Steps**
1. Press the UTILITY key on the front panel followed by pressing the PAGE DOWN soft-key repeatedly until the Test page appears.

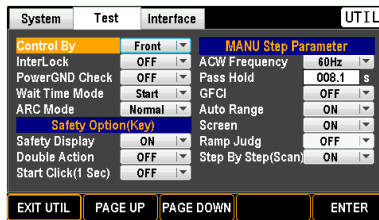

2. Press the ENTER soft-key to enter the Control By field. Use the scroll wheel to select a target method.

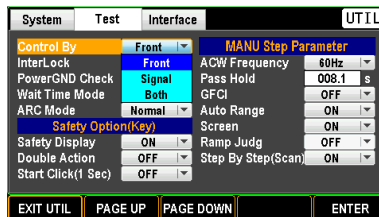

Control By Front, Signal, Both

3. Press the ENTER soft-key to confirm the setting.



## InterLock Setting

**Description** The Interlock function is a safety feature. The interlock function prevents a test from running, unless the interlock pins on the Interlock terminal are shorted. The included interlock wire can be used for this purpose. See page 203 for details.

- Steps**
1. Press the UTILITY key on the front panel followed by pressing the PAGE DOWN soft-key repeatedly until the Test page appears.

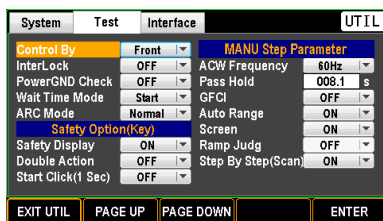

2. Use the scroll wheel to move to the InterLock field.

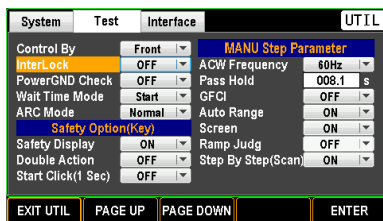

3. Press the ENTER soft-key to enter the InterLock field. Use the scroll wheel to select ON/OFF option.

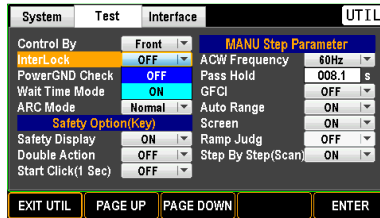

InterLock                      ON, OFF

4. Press the ENTER soft-key to confirm the setting.



When InterLock setting is ON but the interlock pins on the Interlock terminal are Not shorted, the prompt message will appear in either MANU or AUTO mode as the figures below shown.

MANU

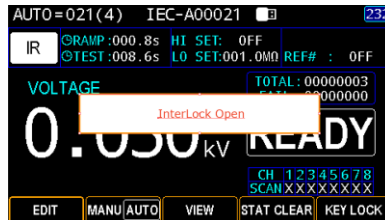

AUTO

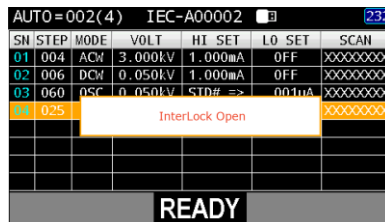

## PowerGND Check Setting

**Description** The Power GND Check detects if the ground terminal from power cord of instrument connects to earth ground properly.

- Steps**
1. Press the UTILITY key on the front panel followed by pressing the PAGE DOWN soft-key repeatedly until the Test page appears.

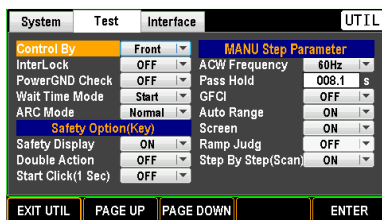

2. Use the scroll wheel to move to the PowerGND Check field.

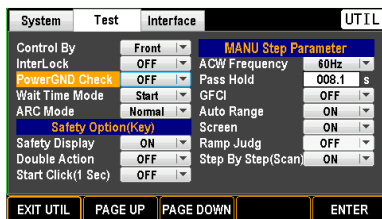

3. Press ENTER soft-key to enter the PowerGND Check field. Use scroll wheel to select ON/OFF option.





## Wait Time Mode Setting

**Description** This section determines the mechanism of Wait Time to begin with. Correlative with Ramp Time and Test Time, Wait Time setting is practical in terms of diversified applications.

- Steps**
1. Press the UTILITY key on the front panel followed by pressing the PAGE DOWN soft-key repeatedly until the Test page appears.

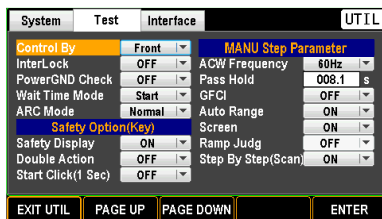
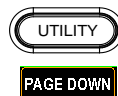

2. Use the scroll wheel to move to the Wait Time Mode field.

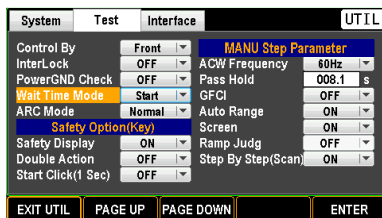

3. Press ENTER soft-key to enter the Wait Time Mode field. Use scroll wheel to select a target option.



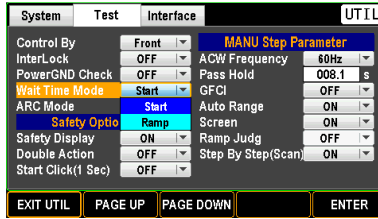

Wait Time Mode                      Start, Ramp

- Start                      Start option allows Wait Time to begin counting in the earliest manner, which means Wait Time runs in the first start with Ramp Time. Test will be judged after end of Wait Time. See the illustration below.

**WAIT TIME MODE : START**



Note

When the Wait Time Mode is set “Start”, the Ramp Judg (page 187) is automatically deactivated.

- Ramp                      Ramp option requests Wait Time to start only after end of Ramp Time. Similarly, test will be judged after end of Wait Time. See the illustration below.

**WAIT TIME MODE : RAMP**



4. Press the ENTER soft-key to confirm the setting.



## ARC Mode Setting

**Description**                      ARC detection, otherwise known as flashover detection, detects fast voltage or current transients that are not normally detected. Arcing is usually an indicator of poor withstanding insulation, electrode gaps or other insulating problems that cause temporary spikes in current or voltage during ACW and DCW testing. ARC mode setting only applies to both ACW and DCW tests.

**Steps**

1. Press the UTILITY key on the front panel followed by pressing the PAGE DOWN soft-key repeatedly until the Test page appears.

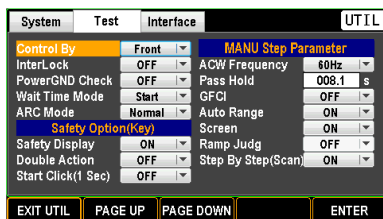

2. Use the scroll wheel to move to the ARC Mode field.

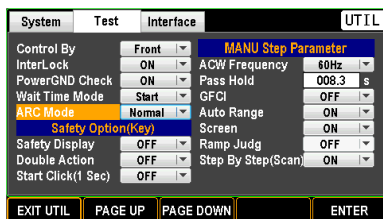

3. Press ENTER soft-key to enter the ARC Mode field. Use scroll wheel to select a preferred option.

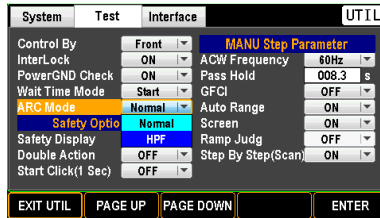

ARC Mode                      Normal, HPF

- Normal                      When ARC detection is activated for ACW or DCW test, the ARC Mode further allows user to set up in details. Normal indicates both High and Low frequency signals would be allowed to pass through.
- HPF                              Oppositely, HPF (High Pass Filter) only permits signals with a higher frequency for certain applications when necessary.

4. Press the ENTER soft-key to confirm the setting.



## Safety Display Setting

**Description** Safety Display has definite relation with the Double Action (page) and the Start Click (1 Sec) (page). It simply acts as a on-screen reminder when the above 2 functions are activated.

- Steps**
1. Press the UTILITY key on the front panel followed by pressing the PAGE DOWN soft-key repeatedly until the Test page appears.

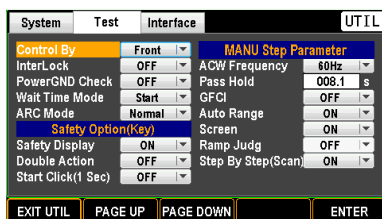

2. Use the scroll wheel to move to the Safety Display field.

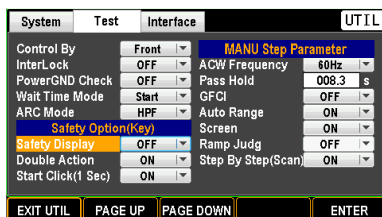

3. Press ENTER soft-key to enter the Safety Display field. Use scroll wheel to select ON/OFF option.



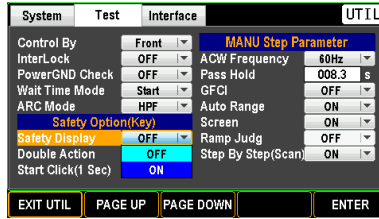

Safety Display ON, OFF

- ON When ON is selected, the screen will be shown as follows if both Double Action and Start Click (1 Sec) are activated.

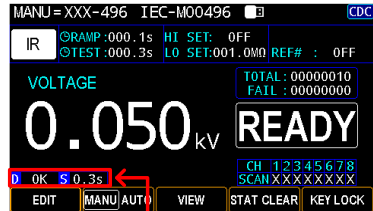

Safety Display for Double Action (D) and Start Click (S) are shown, respectively

- OFF If OFF is opted, there is no prompt message on screen regardless of activation or deactivation of both Double Action and Start Click (1 Sec).

4. Press the ENTER soft-key to confirm the setting.



## Double Action Setting

**Description** Double Action function is a safety feature used to prevent accidentally starting a test. Normally to start a test, the START button is pressed when the tester is in the READY status. To start a test of either MANU or AUTO when Double Action is ON, the STOP button must first be pressed, followed by the START button within 500ms, during which the READY status is in white color; otherwise the status of READY remains in grey color indicating safety protection is activated.

**Steps**

1. Press the UTILITY key on the front panel followed by pressing the PAGE DOWN soft-key repeatedly until the Test page appears.

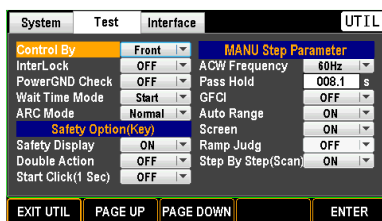

2. Use the scroll wheel to move to the Double Action field.

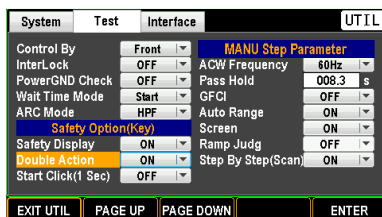

- Press ENTER soft-key to enter the Double Action field. Use scroll wheel to select ON/OFF option.

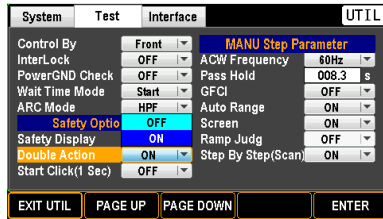

Double Action                      ON, OFF

- ON                      When ON is selected, the screen will be shown as follows if the Safety Display is activated.

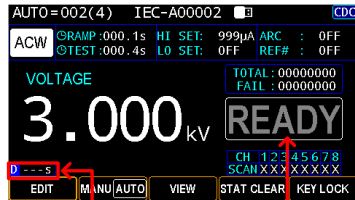

Double Action                      READY status  
 countdown display                      in grey

A countdown of 0.5 second starts after the STOP key is pressed.

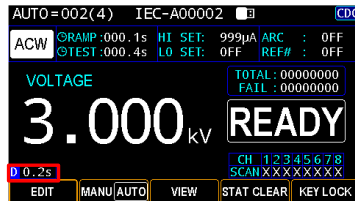

- OFF                      Double Action function is OFF.

- Press the ENTER soft-key to confirm the setting.



## Start Click (1 Sec) Setting

**Description** The Start Click For 1 Second indicates another safety feature that requires the START button being pressed for 1 second so that a test, whether MANU or AUTO, can be started.

- Steps**
1. Press the UTILITY key on the front panel followed by pressing the PAGE DOWN soft-key repeatedly until the Test page appears.

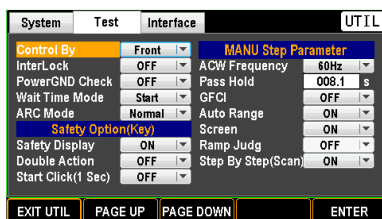

2. Use the scroll wheel to move to the Start Click (1 Sec) field.

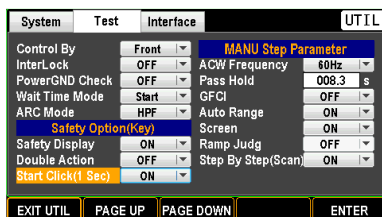

3. Press ENTER soft-key to enter the Double Action field. Use scroll wheel to select ON/OFF option.



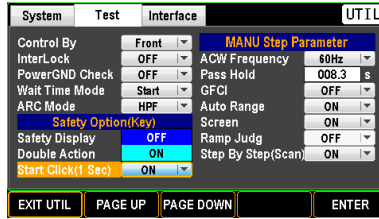

Start Click (1 Sec) ON, OFF

- ON When ON is selected, the screen will be shown as follows if the Safety Display is activated.

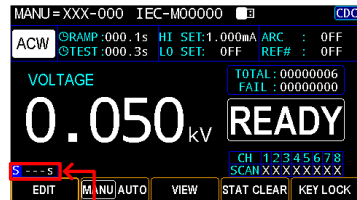

Start Click (1 Sec) countdown display

A countdown of 1 second starts after the START key is being pressed.

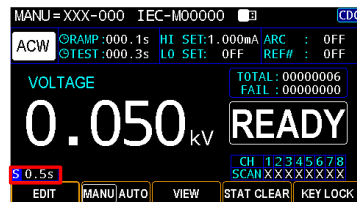

- OFF Start Click (1 Sec) is OFF.

4. Press the ENTER soft-key to confirm the setting.



## ACW Frequency Setting (for MANU)

**Description** A test frequency of 60Hz or 50Hz can be set, regardless of the input line voltage. The test frequency setting only applies to ACW test.

- Steps**
1. Press the UTILITY key on the front panel followed by pressing the PAGE DOWN soft-key repeatedly until the Test page appears.

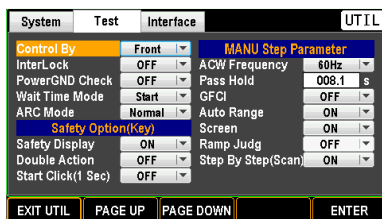

2. Use the scroll wheel to move to the ACW Frequency field.

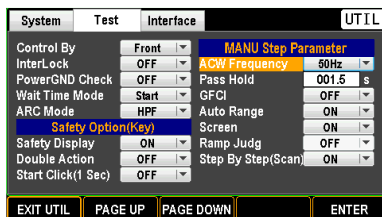

3. Press ENTER soft-key to enter the ACW Frequency field. Use scroll wheel to select an option.



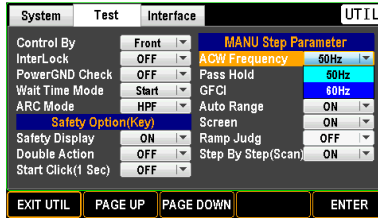

AC FREQ 50Hz, 60Hz

4. Press the ENTER soft-key to confirm the setting.



## Pass Hold Setting (for MANU)

### Description

The PASS HOLD setting refers to the holding duration after PASS judgment is shown on the display. When the PASS HOLD setting is set, a PASS judgment is held until the set duration is fully reached.

### Steps

1. Press the UTILITY key on the front panel followed by pressing the PAGE DOWN soft-key repeatedly until the Test page appears.

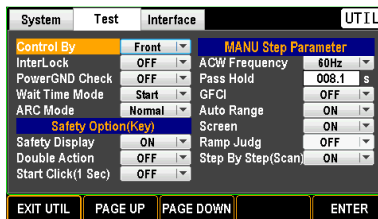
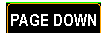

2. Use the scroll wheel to move to the Pass Hold field.





## GFCI Setting (for MANU)

**Description** GFCI function, Ground Fail Check Interrupt, is particularly designed to detect if any electrical leakage or accidental interruption between DUT and GPT-9500. Once issue occurs, output will be stopped and warning message shows accordingly.



**Note**

To activate GFCI, the GR MODE should be disabled for test. Refer to page 63 for details.

**Steps**

1. Press the UTILITY key on the front panel followed by pressing the PAGE DOWN soft-key repeatedly until the Test page appears.

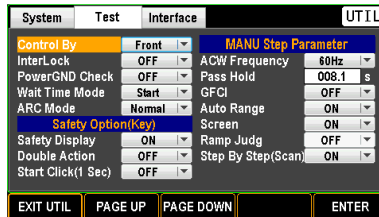

2. Use the scroll wheel to move to the GFCI field.

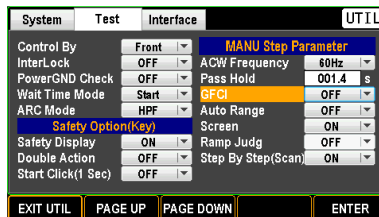

- Press ENTER soft-key to enter the GFCI field. Use scroll wheel to select ON/OFF option.

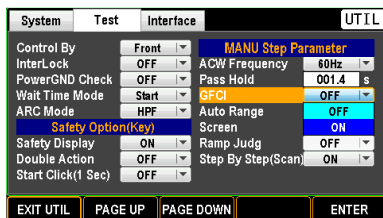

GFCI ON, OFF

- Press the ENTER soft-key to confirm the setting.



GFCI Warning Display

GFCI warning message

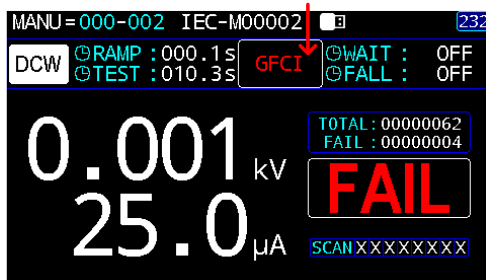

## Auto Range Setting (for MANU)

Description Specifically for DCW test, the unit for measured current can be determined by user preferences.



Note

AUTO RANGE is only applicable to DCW test.

Steps

1. Press the UTILITY key on the front panel followed by pressing the PAGE DOWN soft-key repeatedly until the Test page appears.

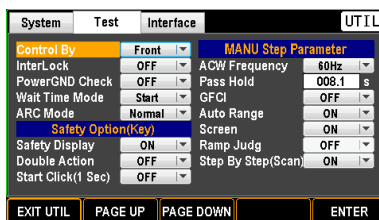

2. Use the scroll wheel to move to the Auto Range field.

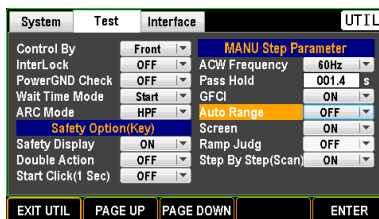

3. Press ENTER soft-key to enter the Auto Range field. Use scroll wheel to select ON/OFF option.



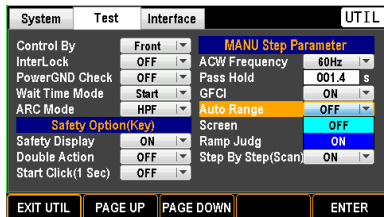

- Auto Range            ON, OFF
- ON                    The displayed ampere unit is auto-adjustable in light of the measured current.
- OFF                   The displayed ampere unit is fixed within the unit of mA all the time.

4. Press the ENTER soft-key to confirm the setting. ENTER

Auto Range Display    ON

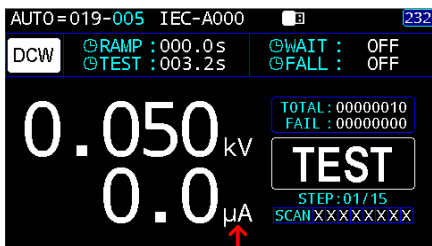

Ampere unit adjusts in accord with measured current

OFF

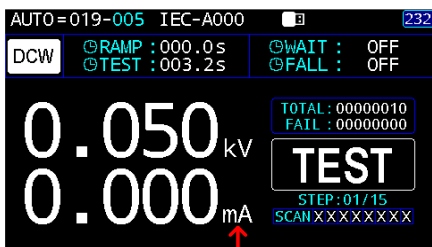

Ampere unit is fixed with the unit of mA

## Screen Setting (for MANU)

**Description** The Screen setting provides up to 3 modes for user's preference while conducting MANU test.

- Steps**
1. Press the UTILITY key on the front panel followed by pressing the PAGE DOWN soft-key repeatedly until the Test page appears.

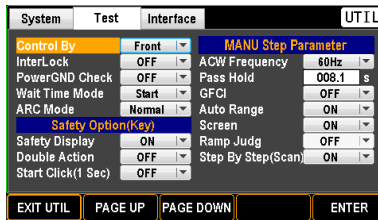

2. Use the scroll wheel to move to the Screen field.

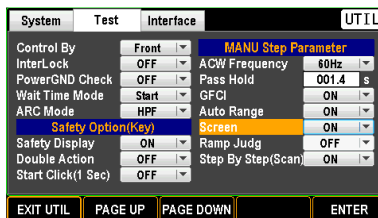

3. Press ENTER soft-key to enter the Screen field. Use scroll wheel to select a preferred option.



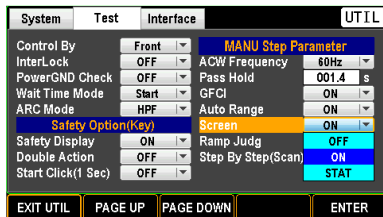

Screen ON, OFF, STAT

ON The MANU test display is shown with intact information normally.

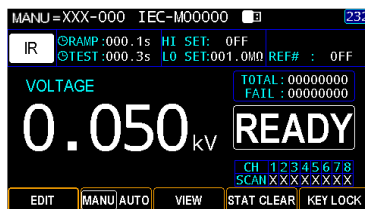

OFF The entire info of MANU test is hidden except the status bar with time display.

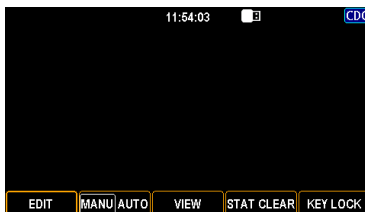

STAT Only the Total test counts, Fail counts and Distortion Rate (D. RATE) is shown under the STAT screen mode.

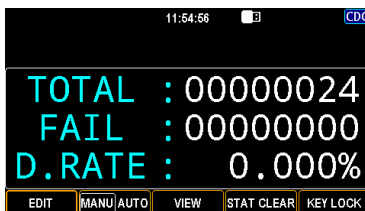

4. Press the ENTER soft-key to confirm the setting.



## Ramp Judg Setting (for MANU)

**Description** In theory, neither PASS nor FAIL status is judged during the ramp up time. However, the Ramp Judg function enables judgment during the ramp duration for certain application.

 **Note** When the Wait Time Mode (page 168) is set “Start”, the Ramp Judg function is automatically deactivated.

- Steps**
1. Press the UTILITY key on the front panel followed by pressing the PAGE DOWN soft-key repeatedly until the Test page appears.

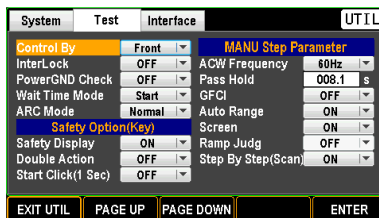

2. Use the scroll wheel to move to the Ramp Judg field.

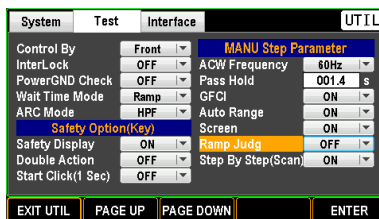

3. Press ENTER soft-key to enter the Ramp Judg field. Use scroll wheel to select ON/OFF option.

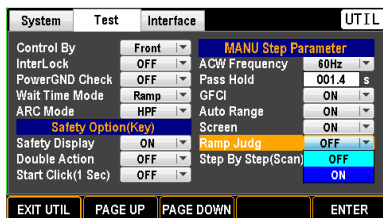

4. Press the ENTER soft-key to confirm the setting.



## Step By Step (Scan) Setting (for MANU)

### Description

In relation with multiple channels output, when 2 above channels are set “H” with none of them in “L”, GPT-9500 will figure out, step by step, which channel(s) is in charge of Fail judgment after test results in FAIL. It is a particularly practical function to verify each output channel. See page 56 for details.



### Note

When the Step By Step (Scan) is set OFF, only a FAIL judgment for test is given without any further details of judgments into each channel. Also, Step By Step (Scan) only supports ACW & DCW modes when it is turned ON.

### Steps

1. Press the UTILITY key on the front panel followed by pressing the PAGE DOWN soft-key repeatedly until the Test page appears.



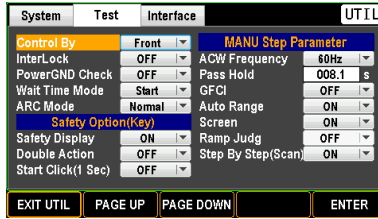

- Use the scroll wheel to move to the Step By Step (Scan) field.

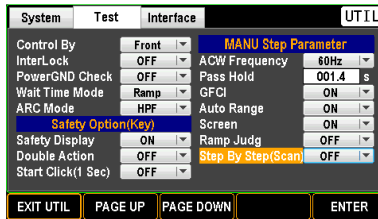

- Press ENTER soft-key to enter the Step By Step (Scan) field. Use scroll wheel to select ON/OFF option.

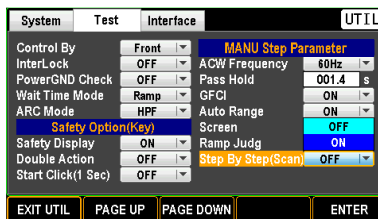

- Press the ENTER soft-key to confirm the setting.



# Interface Setting

## Interface Setting

**Description** The interface settings allows user to choose the remote interface configuration. USB and RS232 can be selected.

- Steps**
1. Press the UTILITY key on the front panel followed by pressing the PAGE DOWN soft-key repeatedly until the Interface page appears.

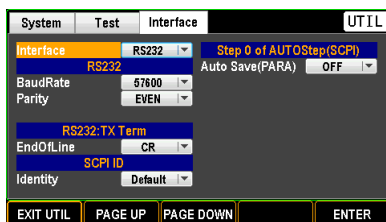

2. Press the ENTER soft-key to enter the Interface field. Use the scroll wheel to select a target option.

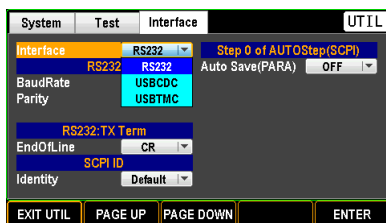

Interface RS232, USBCDC, USBTMC



Note

Before the GPT-9500 can be used for remote control utilizing the CDC or TMC USB class, install the appropriate CDC or TMC USB driver included within the User Manual CD.

**USBCDC:**

The USB port on the GPT-9500 will appear as a virtual COM port to a connected PC.

**USBTMC:**

The GPT-9500 can be controlled using National Instruments NI-Visa software\*. NI-Visa supports USB TMC. To use the TMC interface National Instruments Measurement and Automation Explorer can be used. This program is available on the NI website, [www.ni.com](http://www.ni.com), via a search for the VISA Runtime Engine page, or “downloads” at the following URL, <http://www.ni.com/visa/>

3. Press the ENTER soft-key to confirm the setting.



## Baud Rate Setting

Description

When RS232 interface is selected, move the cursor to the Baud Rate field to set an appropriate setting.

Steps

1. Press the UTILITY key on the front panel followed by pressing the PAGE DOWN soft-key repeatedly until the Interface page appears.



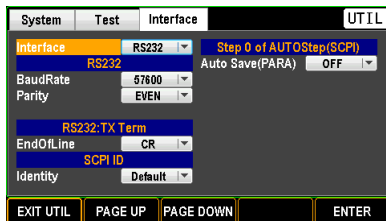

2. Use the scroll wheel to move to the BaudRate field.

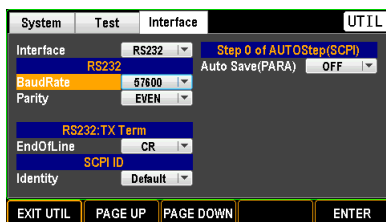

3. Press ENTER soft-key to enter the BaudRate field. Use scroll wheel to select a corresponding rate.

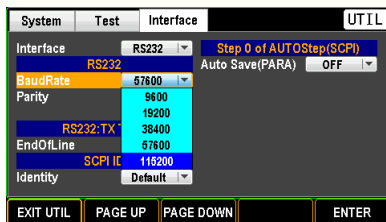

Baud Rate      9600, 19200, 38400, 57600, 115200

4. Press the ENTER soft-key to confirm the setting.



## Parity Setting

**Description** In RS232 communication, there're Even and Odd parity verification in terms of bits transmission. The section here allows user to designate a proper method.

- Steps**
1. Press the UTILITY key on the front panel followed by pressing the PAGE DOWN soft-key repeatedly until the Interface page appears.

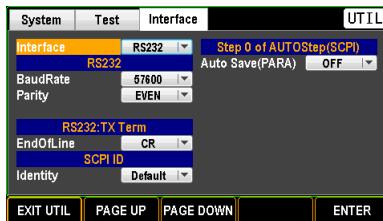

2. Use the scroll wheel to move to the Parity field.

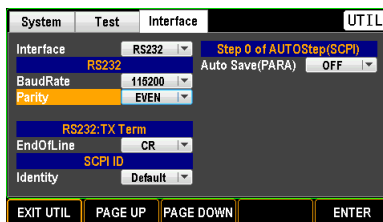

3. Press ENTER soft-key to enter the Parity field. Use scroll wheel to select a target option.



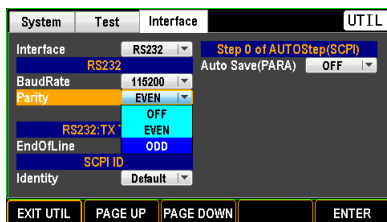

Parity EVEN, ODD

OFF: parity verification is off.

4. Press the ENTER soft-key to confirm the setting.



## End Of Line Setting

**Description** Also, it is necessary to define the rule of End of Line for commands of RS232 remote control.

1. Press the UTILITY key on the front panel followed by pressing the PAGE DOWN soft-key repeatedly until the Interface page appears.

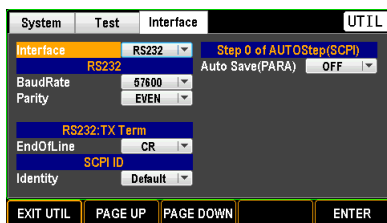

2. Use the scroll wheel to move to the EndOfLine field.



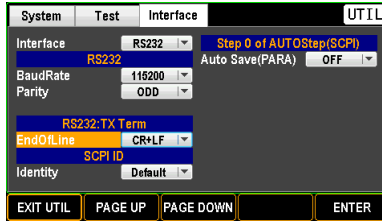

3. Press ENTER soft-key to enter the EndOfLine field. Use scroll wheel to select a target option.

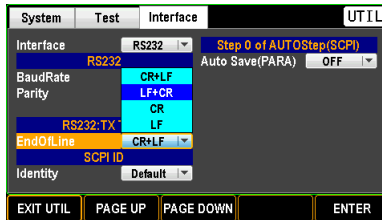

EndOfLine CR+LF, LF+CR, CR, LF

4. Press the ENTER soft-key to confirm the setting.



## SCPI ID Identity Setting

### Description

Generally, the \*IDN? query returns the manufacturer, model number, serial number, among others by Default. When SCPI ID is set to User, a user defined manufacturer and model number is returned with the \*IDN? query. Please see the page 288 for details.

### Steps

1. Press the UTILITY key on the front panel followed by pressing the PAGE DOWN soft-key repeatedly until the Interface page appears.



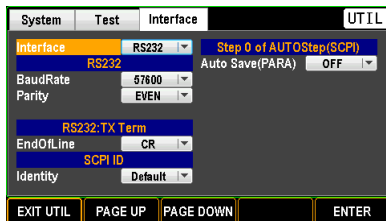

2. Use the scroll wheel to move to the Identity field.

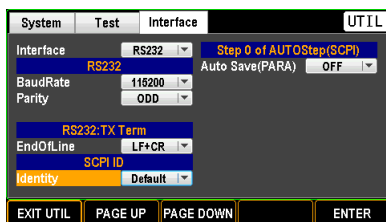

3. Press ENTER soft-key to enter the Identity field. Use scroll wheel to select a target option.

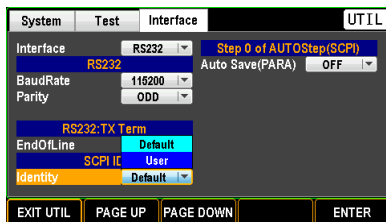

Identity      Default, User

4. Press the ENTER soft-key to confirm the setting.



## Auto Save (PARA) Setting

**Description** For SCPI communication, parameters of each command can be stored in the GPT-9500, by which however heavier burdens slows the efficiency of unit, more or less. User can turn this function On or Off by preference.

**Steps**

1. Press the UTILITY key on the front panel followed by pressing the PAGE DOWN soft-key repeatedly until the Interface page appears.

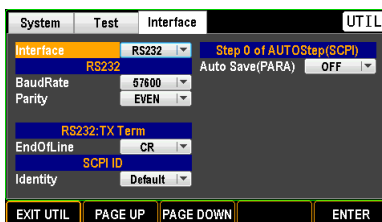

2. Use the scroll wheel to move to the Auto Save (PARA) field.

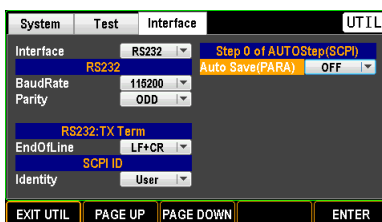

3. Press ENTER soft-key to enter the Auto Save (PARA) field. Use scroll wheel to turn ON/OFF the function.



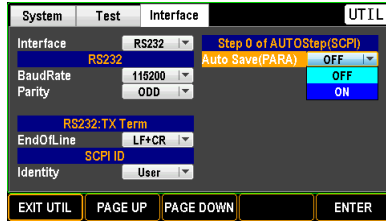

Auto Save (PARA)      ON, OFF

4. Press the ENTER soft-key to confirm the setting.



# E EXTERNAL CONTROL

The External Control chapter covers the  
REMOTE terminal and the SIGNAL I/O port.

---

<b>External Control Overview .....</b>	<b>200</b>
SIGNAL I/O Overview.....	200
Using the SIGNAL I/O to Start/Stop Tests .....	202
Using the Interlock Wire.....	203

## External Control Overview

The External Control section describes the rear panel SIGNAL I/O port.

### SIGNAL I/O Overview

#### Overview

The SIGNAL I/O port can be used to remotely start/stop tests and monitor the test status of the instrument. The SIGNAL I/O port uses a DB-9 pin female connector.

#### Pin Assignment

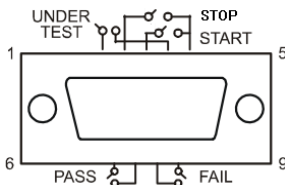

Pin name	Pin	Description
UnderTEST	1	UnderTEST signal Output
STOP	2	Stop signal input
START	3	Start signal input
UnderTEST_COM	4	UnderTEST signal Output COM
INPUT_COM	5	Start/Stop signal input COM
PASS	6	PASS signal Output
PASS_COM	7	PASS signal Output COM
FAIL	8	FAIL signal Output
FAIL_COM	9	FAIL signal Output COM

#### Input Connection

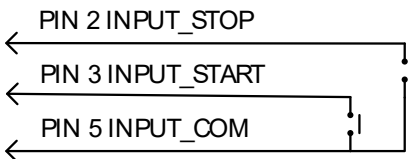

Output Connection

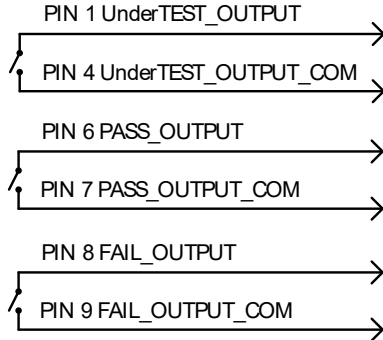

Signal Properties

Input Signals	
High level input voltage	5V ~ 32V
Low level input voltage	0V ~ 1V
Low level input current	Maximum of -5mA
Input period	Minimum of 1ms
Output Signals	
Output Type	Relay form A
Output Rated Voltage	30VDC
Maximum output current	0.5A

Input Stop and Input Start Timing

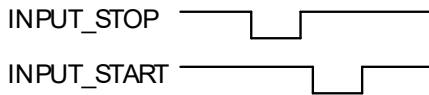

Output Timing

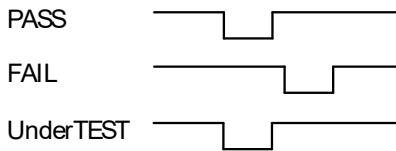

 Note

- Output is able to be deployed by programming.
- Under TEST PIN can be toggled between power symbol and contact symbol. Refer to page 19 for detail.

## Using the SIGNAL I/O to Start/Stop Tests

---

**Background** To use the SIGNAL I/O port the CONTROL settings have to be set to SIGNAL IO in the UTILITY mode.

---

- Panel operation**
1. Set the CONTROL option to Signal Page 163 in the UTILITY mode.
  2. Connect the Input/Output signals to the SIGNAL I/O port.
  3. To start the testing, short the STOP and INPUT\_COM line for a minimum of 1ms to put the tester into READY status.
  4. To start the testing, short the START and INPUT\_COM lines for a minimum of 1ms.
  5. To stop the testing, temporarily short the STOP and INPUT\_COM line again.
- 



### NOTE

Even if the GPT-9500 is configured to use the SIGNAL I/O interface, the STOP button on the front panel can still be used to stop a test.

---

## Using the Interlock Wire

---

**Background** When the INTERLOCK function is set to ON, tests are only allowed to start when Interlock wire is shorted with the Interlock terminal. Use the attached Interlock wire to short the Interlock pins on the Interlock terminal.

---

**Panel operation** 1. Insert the Interlock wire into the Interlock terminal on the rear panel as shown below.

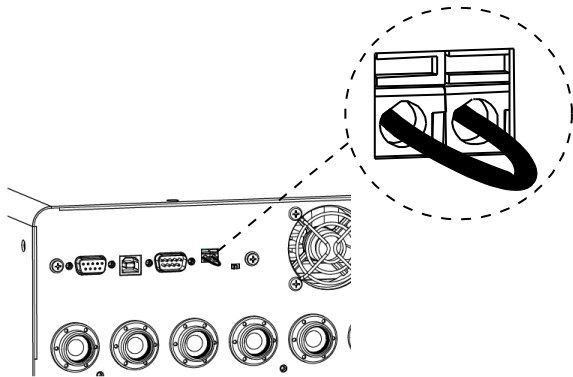

2. Set the Interlock option to ON in [Page 164](#) the UTILITY mode.

---

 **Note**

- With INTERLOCK set to ON, the tester can now only start a test when the Interlock pins are well shorted by the Interlock wire. Do not remove the interlock wire after starting a test. It must be inserted after a test has started or is running.
  - To remove interlock wire, utilize an appropriate flat-head screwdriver to levelly push the terminal inwards followed by pulling the wire out of the terminal. Please proceed with one terminal port per time.
-

# REMOTE CONTROL

This chapter describes basic configuration of IEEE488.2 based remote control. The remote interface supports USB and RS232.

---

<b>Interface Configuration .....</b>	<b>205</b>
<b>Command Syntax .....</b>	<b>209</b>
<b>Command List .....</b>	<b>211</b>

## Interface Configuration

### USB Remote Interface

USB Configuration	PC side connector	Type A, host
	GPT-9500 side connector	Rear panel Type B
	USB Speed	2.0 (Full speed)

- Panel operation
3. Connect the USB cable to the rear panel USB B-Type port.



4. Set the Interface to USB from the UTILITY page.

Page 190

## RS232 Remote Interface

RS232 Configuration	Connection	Non-null modem cable
	Baud rate	9600, 19200, 38400, 57600, 115200
	Parity	OFF, EVEN, ODD
	Data bits	8
	Stop bit	1
	Flow control	None

### Pin Assignment

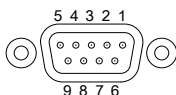

- 1: No connection
- 2: TxD (Transmit Data)
- 3: RxD (Receive Data)
- 4: No connection
- 5: GND
- 6-9: No connection

Connection	PC		GPT-9500	
	DB9 Pin	Signal	Signal	DB9Pin
	2	RxD	TxD	2
	3	TxD	RxD	3
	5	GND	GND	5

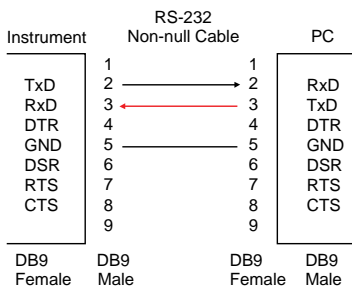

### Panel operation

1. Connect the non-null modem cable to the rear panel RS232 port.

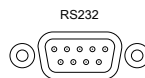

2. Set the Interface to RS232 from the UTILITY page.

Page 190

## USB/RS232 Remote Control Function Check

Functionality check

Invoke a terminal application such as RealTerm.

To check COM port number and other settings, see the Device Manager in PC. For Win10 operation system, from the search box on the taskbar, type Device Manager or right-click the Start button, and then select from the menu.

Run this query command via the terminal after the instrument has been configured for USB or RS-232 remote control.

\*idn?

This should return Model number, Serial number and Firmware version in the format below:

GWInstek,GPT9513,GDM123456,1.00

CR, LF can be used as the terminal character when entering queries/commands from a terminal application.

RMT Display

When the panel is being remotely controlled via the USB or RS232 interfaces, the RMT indicator will be displayed on the screen.

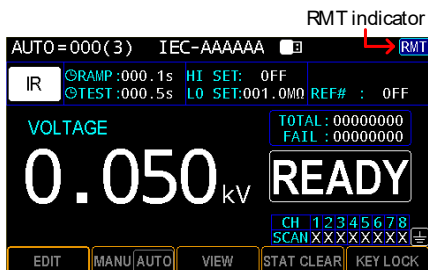

Err Display

When an incorrect command is sent to the tester, the Err indicator will be displayed on the screen indicating there is an error in command.

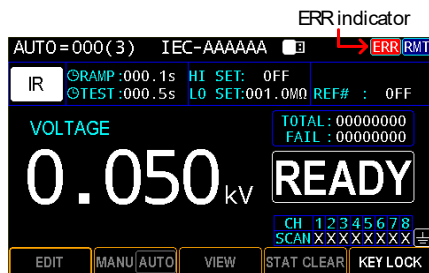

Return to Panel Control

Background

When the instrument is remotely controlled all panel keys except the STOP and START buttons are disabled. Receive a stop signal from either mode of Control By (Front, Signal or Both), while the RMT indicator is displayed, or simply send a SYSTLOCAl command (page 227) to return the instrument back to the panel control.



Note

To put the tester back to the RMT, simply issue another remote control command.

## Command Syntax

---

Compatible Standard	IEEE488.2	Partial compatibility
	SCPI, 1999	Partial compatibility

---

**Command Structure**

SCPI commands follow a tree-like structure, organized into nodes. Each level of the command tree is a node. Each keyword in an SCPI command represents each node in the command tree. Each keyword (node) of an SCPI command is separated by a colon (:).

For example, the diagram below shows an SCPI sub-structure and a command example.

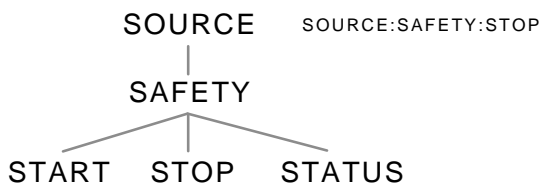

**Command types**

There are a number of different instrument commands and queries. A command sends instructions or data to the unit and a query receives data or status information from the unit.

### Command types

---

**Setting**                      A single or compound command with/without a parameter

**Example**                      SYSTem:ARC:MODE

---

Query	A query is a simple or compound command followed by a question mark (?). A parameter (data) is returned.
-------	----------------------------------------------------------------------------------------------------------

Example	SYSTem:ARC:MODE?
---------	------------------

**Command Forms**      Commands and queries have two different forms, long and short. The command syntax is written with the short form of the command in capitals and the remainder (long form) in lower case.

The commands can be written in capitals or lower-case, just so long as the short or long forms are complete. An incomplete command will not be recognized.

Below are examples of correctly written commands.

Long form	SYSTem:ARC:MODE SYSTEM:ARC:MODE system:arc:mode
-----------	-------------------------------------------------------

Short form	SYST:ARC:MODE syst:arc:mode
------------	--------------------------------

Command Format	<p>SYST:ARC:MODE NORMAL</p> <p>1                    1. Command header                          2. Space                          3. Parameter</p>
----------------	-----------------------------------------------------------------------------------------------------------------------------------------------------------

Message Separator	EOL or ; (semicolon)	Command Separator
-------------------	-------------------------	-------------------

## Command List

---

### System Commands

:SYSTem:CALibration:DATE .....	220
:SYSTem:CALibration:DATE? .....	220
:SYSTem:CALibration:DUE:DATE .....	220
:SYSTem:CALibration:DUE:DATE? .....	220
:SYSTem:CALibration:ALERT:DATE .....	221
:SYSTem:CALibration:ALERT:DATE? .....	221
:SYSTem:CALibration:ALERT:FUNcTION .....	221
:SYSTem:CALibration:ALERT:FUNcTION? .....	221
:SYSTem:CALibration:PROTection .....	222
:SYSTem:CALibration:PROTection? .....	222
:SYSTem:ERRor:[NEXT]? .....	222
:SYSTem:BEEPer[:IMMediate] .....	222
:SYSTem:BEEPer:STATe .....	222
:SYSTem:BEEPer:STATe? .....	223
:SYSTem:BEEPer:ERRor .....	223
:SYSTem:BEEPer:ERRor? .....	223
:SYSTem:BEEPer:VOLume .....	223
:SYSTem:BEEPer:VOLume? .....	223
:SYSTem:CLICk:STATe .....	223
:SYSTem:CLICk:STATe? .....	224
:SYSTem:VERsion? .....	224
:SYSTem:KLOCK .....	224
:SYSTem:KLOCK? .....	224
:SYSTem:LOCK:OWNer? .....	224
:SYSTem:LOCK:REQuest? .....	224
:SYSTem:LOCK:RELease .....	225
:SYSTem:OUTPut:EOF .....	225
:SYSTem:OUTPut:EOF? .....	225
:SYSTem:WAIT:MODE .....	225

:SYSTem:WAIT:MODE? .....	225
:SYSTem:ARC:MODE .....	226
:SYSTem:ARC:MODE? .....	226
:SYSTem:SCPi:MODE .....	226
:SYSTem:SCPi:MODE? .....	226
:SYSTem:SCPi:AUTO:SAVE .....	227
:SYSTem:SCPi:AUTO:SAVE? .....	227
:SYSTem:LOCal .....	227
:SYSTem:REMote .....	227
:SYSTem:RWLock .....	227

### Display Commands

:DISPlay:AUTO:VIEW .....	228
:DISPlay:AUTO:VIEW? .....	228

### Memory Commands

:MEMory:DELeTe:LOCAtion .....	229
:MEMory:FREE:STEP? .....	229
:MEMory:FREE:STATe? .....	229
:MEMory:STATe:DEFine .....	230
:MEMory:STATe:DEFine? .....	230
:MEMory:STATe:LABel? .....	230
:MEMory:NSTates? .....	231

### Source Commands

[:SOURce]:SAFety:FETCh? .....	237
[:SOURce]:SAFety:GCONTinuity:MMETerage? .....	237
[:SOURce]:SAFety:START[:ONCE] .....	238
[:SOURce]:SAFety:START:CSTandard .....	238
[:SOURce]:SAFety:START:OFFSet .....	238
[:SOURce]:SAFety:START:OFFSet? .....	238
[:SOURce]:SAFety:STOP .....	239
[:SOURce]:SAFety:STATus? .....	239
[:SOURce]:SAFety:SNUMber? .....	239
[:SOURce]:SAFety:RESult:ALL[:JUDGment]? .....	239

[:SOURce]:SAFEty:RESult:ALL:OMETerage?.....	240
[:SOURce]:SAFEty:RESult:ALL:MMETerage? .....	240
[:SOURce]:SAFEty:RESult:ALL:TIME[:TEST]? .....	241
[:SOURce]:SAFEty:RESult:ALL:TIME:RAMP? .....	241
[:SOURce]:SAFEty:RESult:ALL:TIME:FALL? .....	241
[:SOURce]:SAFEty:RESult:ALL:TIME:DWELl? .....	241
[:SOURce]:SAFEty:RESult:ALL:MODE?.....	242
[:SOURce]:SAFEty:RESult:COMPEted? .....	242
[:SOURce]:SAFEty:RESult:AREPort[:JUDGment][:MESsage] (RS232 Interface only).....	242
[:SOURce]:SAFEty:RESult:AREPort[:JUDGment][:MESsage]? (RS232 Interface only).....	243
[:SOURce]:SAFEty:RESult:AREPort:OMETerage (RS232 Interface only).....	243
[:SOURce]:SAFEty:RESult:AREPort:OMETerage? (RS232 Interface only).....	244
[:SOURce]:SAFEty:RESult:AREPort:MMETerage (RS232 Interface only).....	244
[:SOURce]:SAFEty:RESult:AREPort:MMETerage? (RS232 Interface only).....	245
[:SOURce]:SAFEty:RESult[:LAST][:JUDGment]? .....	245
[:SOURce]:SAFEty:RESult[:LAST]:OMETerage? .....	246
[:SOURce]:SAFEty:RESult[:LAST]:MMETerage? .....	246
[:SOURce]:SAFEty:RESult[:LAST]:STEP?.....	246
[:SOURce]:SAFEty:RESult[:LAST]:MODE? .....	247
[:SOURce]:SAFEty:RESult:STEP<n>[:JUDGment]? .....	247
[:SOURce]:SAFEty:RESult:STEP<n>:OMETerage? .....	248
[:SOURce]:SAFEty:RESult:STEP<n>:MMETerage? .....	248
[:SOURce]:SAFEty:STEP<n>:DELeTe .....	248
[:SOURce]:SAFEty:STEP<n>:SEt? .....	248
[:SOURce]:SAFEty:STEP<n>:MODE? .....	249
[:SOURce]:SAFEty:STEP<n>:AC[:LEVel] .....	249
[:SOURce]:SAFEty:STEP<n>:AC[:LEVel]? .....	249
[:SOURce]:SAFEty:STEP<n>:AC:LIMit[:HIGH] .....	250
[:SOURce]:SAFEty:STEP<n>:AC:LIMit[:HIGH]? .....	250
[:SOURce]:SAFEty:STEP<n>:AC:LIMit:LOW .....	250
[:SOURce]:SAFEty:STEP<n>:AC:LIMit:LOW? .....	250
[:SOURce]:SAFEty:STEP<n>:AC:LIMit:ARC[:LEVel] .....	251
[:SOURce]:SAFEty:STEP<n>:AC:LIMit:ARC[:LEVel]? .....	251
[:SOURce]:SAFEty:STEP<n>:AC:TIME:DWELl .....	251

[SOURce]:SAFETy:STEP<n>:AC:TIME:DWELI? ..... 252

[SOURce]:SAFETy:STEP<n>:AC:TIME:RAMP ..... 252

[SOURce]:SAFETy:STEP<n>:AC:TIME:RAMP? ..... 252

[SOURce]:SAFETy:STEP<n>:AC:TIME[:TEST] ..... 252

[SOURce]:SAFETy:STEP<n>:AC:TIME[:TEST]? ..... 253

[SOURce]:SAFETy:STEP<n>:AC:TIME:FALL ..... 253

[SOURce]:SAFETy:STEP<n>:AC:TIME:FALL? ..... 253

[SOURce]:SAFETy:STEP<n>:AC:CHANnel[:HIGH] ..... 254

[SOURce]:SAFETy:STEP<n>:AC:CHANnel[:HIGH]? ..... 254

[SOURce]:SAFETy:STEP<n>:AC:CHANnel:LOW ..... 255

[SOURce]:SAFETy:STEP<n>:AC:CHANnel:LOW? ..... 255

[SOURce]:SAFETy:STEP<n>:AC:REF ..... 256

[SOURce]:SAFETy:STEP<n>:AC:REF? ..... 256

[SOURce]:SAFETy:STEP<n>:AC:GROUndmode ..... 256

[SOURce]:SAFETy:STEP<n>:AC:GROUndmode? ..... 256

[SOURce]:SAFETy:STEP<n>:DC[:LEVel] ..... 257

[SOURce]:SAFETy:STEP<n>:DC[:LEVel]? ..... 257

[SOURce]:SAFETy:STEP<n>:DC:LIMit[:HIGH] ..... 257

[SOURce]:SAFETy:STEP<n>:DC:LIMit[:HIGH]? ..... 257

[SOURce]:SAFETy:STEP<n>:DC:LIMit:LOW ..... 258

[SOURce]:SAFETy:STEP<n>:DC:LIMit:LOW? ..... 258

[SOURce]:SAFETy:STEP<n>:DC:LIMit:ARC[:LEVel] ..... 258

[SOURce]:SAFETy:STEP<n>:DC:LIMit:ARC[:LEVel]? ..... 259

[SOURce]:SAFETy:STEP<n>:DC:TIME:DWELI ..... 259

[SOURce]:SAFETy:STEP<n>:DC:TIME:DWELI? ..... 259

[SOURce]:SAFETy:STEP<n>:DC:TIME:RAMP ..... 259

[SOURce]:SAFETy:STEP<n>:DC:TIME:RAMP? ..... 260

[SOURce]:SAFETy:STEP<n>:DC:TIME[:TEST] ..... 260

[SOURce]:SAFETy:STEP<n>:DC:TIME[:TEST]? ..... 260

[SOURce]:SAFETy:STEP<n>:DC:TIME:FALL ..... 261

[SOURce]:SAFETy:STEP<n>:DC:TIME:FALL? ..... 261

[SOURce]:SAFETy:STEP<n>:DC:CHANnel[:HIGH] ..... 261

[SOURce]:SAFETy:STEP<n>:DC:CHANnel[:HIGH]? ..... 262

[SOURce]:SAFETy:STEP<n>:DC:CHANnel:LOW ..... 262

[SOURce]:SAFETy:STEP<n>:DC:CHANnel:LOW? ..... 262

[SOURce]:SAFETy:STEP<n>:DC:REF ..... 263

[SOURce]:SAFETy:STEP<n>:DC:REF? ..... 263

[SOURce]:SAFETy:STEP<n>:DC:GROUndmode ..... 263

[SOURce]:SAFETy:STEP<n>:DC:GROUndmode? ..... 264

[SOURce]:SAFETy:STEP<n>:IR[:LEVel] ..... 264

[:SOURce]:SAFETy:STEP<n>:IR[:LEVel]? .....	264
[:SOURce]:SAFETy:STEP<n>:IR:LIMit:HIGH .....	264
[:SOURce]:SAFETy:STEP<n>:IR:LIMit:HIGH? .....	265
[:SOURce]:SAFETy:STEP<n>:IR:LIMit[:LOW] .....	265
[:SOURce]:SAFETy:STEP<n>:IR:LIMit[:LOW]? .....	265
[:SOURce]:SAFETy:STEP<n>:IR:TIME:DWELl .....	266
[:SOURce]:SAFETy:STEP<n>:IR:TIME:DWELl? .....	266
[:SOURce]:SAFETy:STEP<n>:IR:TIME:RAMP .....	266
[:SOURce]:SAFETy:STEP<n>:IR:TIME:RAMP? .....	266
[:SOURce]:SAFETy:STEP<n>:IR:TIME[:TEST] .....	267
[:SOURce]:SAFETy:STEP<n>:IR:TIME[:TEST]? .....	267
[:SOURce]:SAFETy:STEP<n>:IR:TIME:FALL .....	267
[:SOURce]:SAFETy:STEP<n>:IR:TIME:FALL? .....	267
[:SOURce]:SAFETy:STEP<n>:IR:RANGe[:UPPer] .....	268
[:SOURce]:SAFETy:STEP<n>:IR:RANGe[:UPPer]? .....	268
[:SOURce]:SAFETy:STEP<n>:IR:RANGe:LOWer .....	268
[:SOURce]:SAFETy:STEP<n>:IR:RANGe:LOWer? .....	269
[:SOURce]:SAFETy:STEP<n>:IR:RANGe:AUTO .....	269
[:SOURce]:SAFETy:STEP<n>:IR:RANGe:AUTO? .....	269
[:SOURce]:SAFETy:STEP<n>:IR:CHANnel[:HIGH] .....	270
[:SOURce]:SAFETy:STEP<n>:IR:CHANnel[:HIGH]? .....	270
[:SOURce]:SAFETy:STEP<n>:IR:CHANnel:LOW .....	270
[:SOURce]:SAFETy:STEP<n>:IR:CHANnel:LOW? .....	271
[:SOURce]:SAFETy:STEP<n>:IR:REF .....	271
[:SOURce]:SAFETy:STEP<n>:IR:REF? .....	271
[:SOURce]:SAFETy:STEP<n>:IR:GROUndmode.....	272
[:SOURce]:SAFETy:STEP<n>:IR:GROUndmode? .....	272
[:SOURce]:SAFETy:STEP<n>:OSC:LIMit:OPEN .....	272
[:SOURce]:SAFETy:STEP<n>:OSC:LIMit:OPEN? .....	273
[:SOURce]:SAFETy:STEP<n>:OSC:LIMit:SHORT.....	273
[:SOURce]:SAFETy:STEP<n>:OSC:LIMit:SHORT? .....	273
[:SOURce]:SAFETy:STEP<n>:OSC:CHANnel[:HIGH] .....	274
[:SOURce]:SAFETy:STEP<n>:OSC:CHANnel[:HIGH]? .....	274
[:SOURce]:SAFETy:STEP<n>:OSC:CHANnel:LOW .....	274
[:SOURce]:SAFETy:STEP<n>:OSC:CHANnel:LOW? .....	275
[:SOURce]:SAFETy:STEP<n>:OSC:CSTandard .....	275
[:SOURce]:SAFETy:STEP<n>:OSC:CSTandard? .....	275
[:SOURce]:SAFETy:STEP<n>:PAuse[:MESSAge].....	276
[:SOURce]:SAFETy:STEP<n>:PAuse[:MESSAge]? .....	276
[:SOURce]:SAFETy:STEP<n>:PAuse:UTSignal .....	276

[:SOURce]:SAFETy:STEP<n>:PAuse:UTSIGNAL?	277
[:SOURce]:SAFETy:STEP<n>:PAuse:TIME[:TEST]	277
[:SOURce]:SAFETy:STEP<n>:PAuse:TIME[:TEST]?	277
[:SOURce]:SAFETy:PRESet:TIME:PASS	278
[:SOURce]:SAFETy:PRESet:TIME:PASS?	278
[:SOURce]:SAFETy:PRESet:TIME:STEP	278
[:SOURce]:SAFETy:PRESet:TIME:STEP?	278
[:SOURce]:SAFETy:PRESet:RJUDgment	279
[:SOURce]:SAFETy:PRESet:RJUDgment?	279
[:SOURce]:SAFETy:PRESet:AC:FREQuency	279
[:SOURce]:SAFETy:PRESet:AC:FREQuency?	279
[:SOURce]:SAFETy:PRESet:WRANge[:AUTO]	280
[:SOURce]:SAFETy:PRESet:WRANge[:AUTO]?	280
[:SOURce]:SAFETy:PRESet:GFI[:SWITCh]	280
[:SOURce]:SAFETy:PRESet:GFI[:SWITCh]?	280
[:SOURce]:SAFETy:PRESet:GCONtinuity	281
[:SOURce]:SAFETy:PRESet:GCONtinuity?	281
[:SOURce]:SAFETy:PRESet:GCONtinuity:THRRehold	281
[:SOURce]:SAFETy:PRESet:FAIL:OPERation	281
[:SOURce]:SAFETy:PRESet:FAIL:OPERation?	282
[:SOURce]:SAFETy:PRESet:SCREen	282
[:SOURce]:SAFETy:PRESet:SCREen?	282
[:SOURce]:SAFETy:PRESet:NUMber:PART	282
[:SOURce]:SAFETy:PRESet:NUMber:PART?	283
[:SOURce]:SAFETy:PRESet:NUMber:LOT	283
[:SOURce]:SAFETy:PRESet:NUMber:LOT?	283
[:SOURce]:SAFETy:PRESet:NUMber:SERIal	283
[:SOURce]:SAFETy:PRESet:NUMber:SERIal?	284

**Common Commands**

*CLS .....	285
*ESE.....	285
*ESE? .....	286
*ESR? .....	286
*SRE .....	286
*SRE?.....	286
*STB? .....	287
*OPC .....	287
*OPC? .....	287
*PSC .....	287
*PSC? .....	287
*RST .....	287
*IDN? .....	288
*SAV.....	288
*RCL.....	288

## System Commands

:SYSTem:CALibration:DATE .....	220
:SYSTem:CALibration:DATE? .....	220
:SYSTem:CALibration:DUE:DATE.....	220
:SYSTem:CALibration:DUE:DATE?.....	220
:SYSTem:CALibration:ALERt:DATE .....	221
:SYSTem:CALibration:ALERt:DATE?.....	221
:SYSTem:CALibration:ALERt:FUNcTion .....	221
:SYSTem:CALibration:ALERt:FUNcTion? .....	221
:SYSTem:CALibration:PROTection .....	222
:SYSTem:CALibration:PROTection? .....	222
:SYSTem:ERRor:[NEXT]?.....	222
:SYSTem:BEEPer[:IMMediate] .....	222
:SYSTem:BEEPer:STATe .....	222
:SYSTem:BEEPer:STATe? .....	223
:SYSTem:BEEPer:ERRor .....	223
:SYSTem:BEEPer:ERRor? .....	223
:SYSTem:BEEPer:VOLume .....	223
:SYSTem:BEEPer:VOLume? .....	223
:SYSTem:CLICk:STATe.....	223
:SYSTem:CLICk:STATe? .....	224
:SYSTem:VERSIon? .....	224
:SYSTem:KLOCK .....	224
:SYSTem:KLOCK? .....	224
:SYSTem:LOCK:OWNer? .....	224
:SYSTem:LOCK:REQuest? .....	224
:SYSTem:LOCK:RELease .....	225
:SYSTem:OUTPut:EOF .....	225
:SYSTem:OUTPut:EOF? .....	225
:SYSTem:WAIT:MODE .....	225

---

:SYSTem:WAIT:MODE?.....	225
:SYSTem:ARC:MODE.....	226
:SYSTem:ARC:MODE?.....	226
:SYSTem:SCPi:MODE.....	226
:SYSTem:SCPi:MODE?.....	226
:SYSTem:SCPi:AUTO:SAVE.....	227
:SYSTem:SCPi:AUTO:SAVE?.....	227
:SYSTem:LOCal.....	227
:SYSTem:REMOte.....	227
:SYSTem:RWLock.....	227

---

**:SYSTem:CALibration:DATE**

---

Sets the calibration date.

Parameter: <NR1> (year, month, day)

Example: SYST:CAL:DATE 2020,4,1

Sets the date to 2020/4/1.

year: 2000~2098

month: 1~12

day: 1~31

---

---

**:SYSTem:CALibration:DATE?**

---

Returns the calibration date.

Return parameter: <Date>, Ex: 2020,4,1

---

---

**:SYSTem:CALibration:DUE:DATE**

---

Sets the next calibration date.

Parameter: <NR1> (year, month, day)

Example: SYST:CAL:DUE:DATE 2021,4,1

Sets the date to 2021/4/1.

year: 2000~2099

month: 1~12

day: 1~31

---

---

**:SYSTem:CALibration:DUE:DATE?**

---

Returns the next calibration date.

Return parameter: <Date>, Ex: 2021,4,1

---

---

**:SYSTem:CALibration:ALERt:DATE**

---

Sets the alert date of the calibration.

Parameter: <NR1> (year, month, day)

Example: SYST:CAL:ALER:DATE 2021,3,1

Sets the date to 2021/3/1.

year: 2000~2099

month: 1~12

day: 1~31

---

---

**:SYSTem:CALibration:ALERt:DATE?**

---

Returns the alert date of the calibration.

Return parameter: <Date>, Ex: 2021,3,1

---

---

**:SYSTem:CALibration:ALERt:FUNCTion**

---

Sets the alert function of the calibration.

Parameter: 0 | 1 | ON | OFF

Example: SYST:CAL:ALER:FUNC ON

Allows the alert function of the calibration.

---

---

**:SYSTem:CALibration:ALERt:FUNCTion?**

---

Returns the status of the alert function of the calibration.

Return parameter: 0 | 1, 0=OFF, 1=ON

---

---

**:SYSTEM:CALibration:PROTection**

---

Sets the protection mechanism of the calibration.

Parameter: 0 | 1 | ON | OFF

Example: SYST:CAL:PROT ON

Allows the calibration protection mechanism.

---

---

**:SYSTEM:CALibration:PROTection?**

---

Returns the status of the calibration protection mechanism.

Return parameter: 0 | 1, 0=OFF, 1=ON

---

---

**:SYSTEM:ERRor:[NEXT]?**

---

Returns the current system error, if any.

---

---

**:SYSTEM:BEEPer[:IMMediate]**

---

Makes buzzer beep once.

Parameter: <None>

Example: SYST:BEEP:IMM

---

---

**:SYSTEM:BEEPer:STATe**

---

Turns the buzzer on/off.

Parameter: 0 | 1 | ON | OFF

Example: SYST:BEEP:STAT OFF

Turns the buzzer off.

\* The key sound of front panel is Not affected by the state.

\* The command of SYSTem:BEEPer is Not affected by the state.

---

---

**:SYSTem:BEEPer:STATe?**

---

Returns the buzzer state.

Return parameter: 0 | 1, 1=ON, 0=OFF.

---

---

**:SYSTem:BEEPer:ERRor**

---

Sets the beeper to sound for an SCPI error.

Parameter: 0 | 1 | ON | OFF

Example: SYST:BEEP:ERR ON

Allows the beeper to sound when an SCPI error occurs.

---

---

**:SYSTem:BEEPer:ERRor?**

---

Returns the beeper error mode.

Return parameter: 0 | 1, 0=OFF, 1=ON

---

---

**:SYSTem:BEEPer:VOLume**

---

Sets the beeper volume.

Parameter: <NR1> (0 ~ 3)

Example: SYST:BEEP:VOL 2

Sets the beeper volume to medium.

---

---

**:SYSTem:BEEPer:VOLume?**

---

Returns the beeper volume of Hold function.

Return parameter: OFF | SMALL | MEDIUM | LARGE

---

---

**:SYSTem:CLICk:STATe**

---

Turns the key sound of front panel on/off.

---

Parameter: 0 | 1 | ON | OFF

Example: SYST:CLIC:STAT OFF

Turns key sound off.

---

:SYSTEM:CLICK:STATE?

---

Returns the key sound of front panel state.

Return Parameter: 0 | 1, 1=ON, 0=OFF.

---

:SYSTEM:VERSION?

---

Returns SCPI version.

Return parameter: 1994.0.

---

:SYSTEM:KLOCK

---

Sets the LOCAL key to locked or released.

Example: SYST:KLOC ON

Sets the LOCAL key locked for front panel.

---

:SYSTEM:KLOCK?

---

Returns the LOCAL key of front panel state.

Return parameter: 0 | 1, 0=unlocked, 1=locked.

---

:SYSTEM:LOCK:OWNER?

---

Returns the remote control state.

Return Parameter: NONE | REMOTE.

---

:SYSTEM:LOCK:REQUEST?

---

---

Enables remote control and returns message "1".

Return parameter: 1, already set to the status of remote control.

---

### :SYSTem:LOCK:RELease

---

Enables local control (front panel control) and disables remote control.

---

### :SYSTem:OUTPut:EOF

---

Sets the EOL character (CR+LF, LF+CR, CR, LF).

Parameter: <NR1>(0~ 3) (0=CR+LF, 1=LF+CR, 2=CR, 3=LF)

Example: SYST:OUTP:EOF 0

Sets the EOL character as CR+LF.

\* The parameters will not be saved.

---

### :SYSTem:OUTPut:EOF?

---

Returns the EOL character.

Return parameter: 0 | 1 | 2 | 3 (0=CR+LF, 1=LF+CR, 3=CR, 4=LF)

---

### :SYSTem:WAIT:MODE

---

Sets the Wait Time Mode.

Parameter: START | RAMP.

Example: SYST:WAIT:MODE START.

Sets the Wait Time Mode to Start.

---

### :SYSTem:WAIT:MODE?

---

Returns the Wait Time Mode.

---

Return parameter: START | RAMP.

---

### :SYSTem:ARC:MODE

---

Sets the ARC Mode.

Parameter: NORMAL | HPF.

Example: SYST:ARC:MODE NORMAL.

Sets the ARC Mode to Normal mode.

---

### :SYSTem:ARC:MODE?

---

Returns the ARC Mode.

Return parameter: NORMAL | HPF.

---

### :SYSTem:SCPi:MODE

---

Sets the SCPI mode. The SCPI mode is used to determine whether the \*IDN? query returns the "DEFAULT" or "USER" identification string.

Parameter: DEFAULT | USER.

Example: SYST:SCP:MODE DEFAULT.

Sets the SCPI mode to default.

\* The parameters will not be saved.

---

### :SYSTem:SCPi:MODE?

---

Returns the SCPI mode. The SCPI mode is used to determine whether the \*IDN? query returns the "DEFAULT" or "USER" identification string.

Return parameter: DEFAULT | USER.

---

---

**:SYSTem:SCPi:AUTO:SAVE**

---

Do the setting parameters need to be saved automatically for SCPI command?

Parameter: 0 | 1, 1=ON, 0=OFF.

Example: SYST:SCP:AUTO:SAVE ON.

Sets the parameters automatically saved.

\* Parameters auto saving generally takes some time. Hence, it is suggested to disable the function when no necessity occurs.

---

---

**:SYSTem:SCPi:AUTO:SAVE?**

---

Returns the autosave for scpi command mode.

Parameter: 0 | 1.

---

---

**:SYSTem:LOCal**

---

Enables local control (front panel control) and disables remote control.

---

---

**:SYSTem:REMote**

---

Enables remote control and disables local control (front panel control), all key are disabled except ESC key (return to local control).

---

---

**:SYSTem:RWLock**

---

Enables remote control and disables local control (front panel control, all key are disable).

---

## Display Commands

---

:DISPlay:AUTO:VIEW .....	228
:DISPlay:AUTO:VIEW? .....	228

### :DISPlay:AUTO:VIEW

---

Sets the step view mode of AUTO step

Parameter: LIST | SINGLE.

Example: DISP:AUTO:VIEW LIST.

Sets the step view mode to list mode.

---

### :DISPlay:AUTO:VIEW?

---

Returns the step view mode of AUTO step

Return parameter: LIST | SINGLE.

---

## Memory Commands

---

:MEMory:DELeTe:LOCAtion .....	229
:MEMory:FREE:STEP? .....	229
:MEMory:FREE:STATe? .....	229
:MEMory:STATe:DEFine .....	230
:MEMory:STATe:DEFine? .....	230
:MEMory:STATe:LABel? .....	230
:MEMory:NStates? .....	231

### :MEMory:DELeTe:LOCAtion

---

This command deletes the parameter data in the main memory.

Parameter: <NR1>(0 ~ 99)

Example: MEM:DEL:LOCA 1

It means to delete the first group of parameter data in the main memory.

---

### :MEMory:FREE:STEP?

---

Returns the rest MANU step number in the main memory.

Return parameter: <NR1> (rested MANU step), <NR1> (used MANU step)

Example: MEM:FREE:STEP?

> 495,5

Rested 495 MANU step, used 5 MANU step

---

### :MEMory:FREE:STATe?

---

Returns the rest AUTO step number in the main memory.

Return parameter: <NR1> (rested step), <NR1> (used step)

Example: MEM:FREE:STAT?

---

> 95,5

Rested 95 AUTO step, used 5 AUTO step

---

### :MEMory:STATe:DEFine

---

Sets the name of the AUTO step of a certain memory in the main memory.

Parameter: <string>name, <NR1> (0 ~ 99) AUTO step

Example: MEM:STAT:DEF Test, 1

Sets the first group of parameter data name in the main memory is Test.

---

### :MEMory:STATe:DEFine?

---

Returns the AUTO step in the main memory by the name of memory.

Parameter: <string> name

Return Parameter: <NR1> (0 ~ 99) AUTO step

Example: MEM:STAT:DEF? Test

> 1

Return message "1" means the parameter data location of Test is at the first AUTO step.

---

### :MEMory:STATe:LABel?

---

Returns the name in the main memory by the AUTO step of the memory.

Parameter: <NR1>(0 ~ 99)AUTO step

Return Parameter: <string>name

Example: MEM:STAT:LAB? 1

> Test

Return message "Test" means the first AUTO step parameter data name is Test.

---

### :MEMory:NStates?

---

Returns the storage capacity in the main memory.

The storage capacity return to the main memory is the maximum value plus one.

Example: MEM:NST?

> 100

The message "100" means the storage capacity of the main memory is 99 groups (100-1).

---

## Source Commands

[:SOURce]:SAFETy:FETCh? .....	237
[:SOURce]:SAFETy:GCONtinuity:MMETerage?.....	237
[:SOURce]:SAFETy:STARt[:ONCE].....	238
[:SOURce]:SAFETy:STARt:CSTandard .....	238
[:SOURce]:SAFETy:STARt:OFFSet .....	238
[:SOURce]:SAFETy:STARt:OFFSet? .....	238
[:SOURce]:SAFETy:STOP .....	239
[:SOURce]:SAFETy:STATus?.....	239
[:SOURce]:SAFETy:SNUMber?.....	239
[:SOURce]:SAFETy:RESult:ALL[:JUDGment]?.....	239
[:SOURce]:SAFETy:RESult:ALL:OMETerage? .....	240
[:SOURce]:SAFETy:RESult:ALL:MMETerage?.....	240
[:SOURce]:SAFETy:RESult:ALL:TIME[:TEST]? .....	241
[:SOURce]:SAFETy:RESult:ALL:TIME:RAMP? .....	241
[:SOURce]:SAFETy:RESult:ALL:TIME:FALL?.....	241
[:SOURce]:SAFETy:RESult:ALL:TIME:DWELI?.....	241
[:SOURce]:SAFETy:RESult:ALL:MODE? .....	242
[:SOURce]:SAFETy:RESult:COMPleted? .....	242
[:SOURce]:SAFETy:RESult:AREPort[:JUDGment][:MESsage] (RS232 Interface only) .....	242
[:SOURce]:SAFETy:RESult:AREPort[:JUDGment][:MESsage]? (RS232 Interface only) .....	243
[:SOURce]:SAFETy:RESult:AREPort:OMETerage (RS232 Interface only) .....	243
[:SOURce]:SAFETy:RESult:AREPort:OMETerage? (RS232 Interface only) .....	244
[:SOURce]:SAFETy:RESult:AREPort:MMETerage (RS232 Interface only) .....	244
[:SOURce]:SAFETy:RESult:AREPort:MMETerage? (RS232 Interface only) .....	245
[:SOURce]:SAFETy:RESult[:LAST][:JUDGment]?.....	245
[:SOURce]:SAFETy:RESult[:LAST]:OMETerage?.....	246
[:SOURce]:SAFETy:RESult[:LAST]:MMETerage? .....	246
[:SOURce]:SAFETy:RESult[:LAST]:STEP?.....	246
[:SOURce]:SAFETy:RESult[:LAST]:MODE?.....	247
[:SOURce]:SAFETy:RESult:STEP<n>[:JUDGment]? .....	247
[:SOURce]:SAFETy:RESult:STEP<n>:OMETerage? .....	248

[:SOURce]:SAFETy:RESult:STEP<n>:MMETerage?	248
[:SOURce]:SAFETy:STEP<n>:DELete	248
[:SOURce]:SAFETy:STEP<n>:SET?	248
[:SOURce]:SAFETy:STEP<n>:MODE?	249
[:SOURce]:SAFETy:STEP<n>:AC[:LEVel]	249
[:SOURce]:SAFETy:STEP<n>:AC[:LEVel]?	249
[:SOURce]:SAFETy:STEP<n>:AC:LIMit[:HIGH]	250
[:SOURce]:SAFETy:STEP<n>:AC:LIMit[:HIGH]?	250
[:SOURce]:SAFETy:STEP<n>:AC:LIMit:LOW	250
[:SOURce]:SAFETy:STEP<n>:AC:LIMit:LOW?	250
[:SOURce]:SAFETy:STEP<n>:AC:LIMit:ARC[:LEVel]	251
[:SOURce]:SAFETy:STEP<n>:AC:LIMit:ARC[:LEVel]?	251
[:SOURce]:SAFETy:STEP<n>:AC:TIME:DWELl	251
[:SOURce]:SAFETy:STEP<n>:AC:TIME:DWELl?	252
[:SOURce]:SAFETy:STEP<n>:AC:TIME:RAMP	252
[:SOURce]:SAFETy:STEP<n>:AC:TIME:RAMP?	252
[:SOURce]:SAFETy:STEP<n>:AC:TIME[:TEST]	252
[:SOURce]:SAFETy:STEP<n>:AC:TIME[:TEST]?	253
[:SOURce]:SAFETy:STEP<n>:AC:TIME:FALL	253
[:SOURce]:SAFETy:STEP<n>:AC:TIME:FALL?	253
[:SOURce]:SAFETy:STEP<n>:AC:CHANnel[:HIGH]	254
[:SOURce]:SAFETy:STEP<n>:AC:CHANnel[:HIGH]?	254
[:SOURce]:SAFETy:STEP<n>:AC:CHANnel:LOW	255
[:SOURce]:SAFETy:STEP<n>:AC:CHANnel:LOW?	255
[:SOURce]:SAFETy:STEP<n>:AC:REF	256
[:SOURce]:SAFETy:STEP<n>:AC:REF?	256
[:SOURce]:SAFETy:STEP<n>:AC:GROUmdmode	256
[:SOURce]:SAFETy:STEP<n>:AC:GROUmdmode?	256
[:SOURce]:SAFETy:STEP<n>:DC[:LEVel]	257
[:SOURce]:SAFETy:STEP<n>:DC[:LEVel]?	257
[:SOURce]:SAFETy:STEP<n>:DC:LIMit[:HIGH]	257
[:SOURce]:SAFETy:STEP<n>:DC:LIMit[:HIGH]?	257
[:SOURce]:SAFETy:STEP<n>:DC:LIMit:LOW	258
[:SOURce]:SAFETy:STEP<n>:DC:LIMit:LOW?	258
[:SOURce]:SAFETy:STEP<n>:DC:LIMit:ARC[:LEVel]	258
[:SOURce]:SAFETy:STEP<n>:DC:LIMit:ARC[:LEVel]?	259
[:SOURce]:SAFETy:STEP<n>:DC:TIME:DWELl	259
[:SOURce]:SAFETy:STEP<n>:DC:TIME:DWELl?	259
[:SOURce]:SAFETy:STEP<n>:DC:TIME:RAMP	259
[:SOURce]:SAFETy:STEP<n>:DC:TIME:RAMP?	260

[:SOURce]:SAFETy:STEP<n>:DC:TIME[:TEST]	260
[:SOURce]:SAFETy:STEP<n>:DC:TIME[:TEST]?	260
[:SOURce]:SAFETy:STEP<n>:DC:TIME:FALL	261
[:SOURce]:SAFETy:STEP<n>:DC:TIME:FALL?	261
[:SOURce]:SAFETy:STEP<n>:DC:CHANnel[:HIGH]	261
[:SOURce]:SAFETy:STEP<n>:DC:CHANnel[:HIGH]?	262
[:SOURce]:SAFETy:STEP<n>:DC:CHANnel:LOW	262
[:SOURce]:SAFETy:STEP<n>:DC:CHANnel:LOW?	262
[:SOURce]:SAFETy:STEP<n>:DC:REF	263
[:SOURce]:SAFETy:STEP<n>:DC:REF?	263
[:SOURce]:SAFETy:STEP<n>:DC:GROUndmode	263
[:SOURce]:SAFETy:STEP<n>:DC:GROUndmode?	264
[:SOURce]:SAFETy:STEP<n>:IR[:LEVel]	264
[:SOURce]:SAFETy:STEP<n>:IR[:LEVel]?	264
[:SOURce]:SAFETy:STEP<n>:IR:LIMit:HIGH	264
[:SOURce]:SAFETy:STEP<n>:IR:LIMit:HIGH?	265
[:SOURce]:SAFETy:STEP<n>:IR:LIMit[:LOW]	265
[:SOURce]:SAFETy:STEP<n>:IR:LIMit[:LOW]?	265
[:SOURce]:SAFETy:STEP<n>:IR:TIME:DWELL	266
[:SOURce]:SAFETy:STEP<n>:IR:TIME:DWELL?	266
[:SOURce]:SAFETy:STEP<n>:IR:TIME:RAMP	266
[:SOURce]:SAFETy:STEP<n>:IR:TIME:RAMP?	266
[:SOURce]:SAFETy:STEP<n>:IR:TIME[:TEST]	267
[:SOURce]:SAFETy:STEP<n>:IR:TIME[:TEST]?	267
[:SOURce]:SAFETy:STEP<n>:IR:TIME:FALL	267
[:SOURce]:SAFETy:STEP<n>:IR:TIME:FALL?	267
[:SOURce]:SAFETy:STEP<n>:IR:RANGe[:UPPer]	268
[:SOURce]:SAFETy:STEP<n>:IR:RANGe[:UPPer]?	268
[:SOURce]:SAFETy:STEP<n>:IR:RANGe:LOWer	268
[:SOURce]:SAFETy:STEP<n>:IR:RANGe:LOWer?	269
[:SOURce]:SAFETy:STEP<n>:IR:RANGe:AUTO	269
[:SOURce]:SAFETy:STEP<n>:IR:RANGe:AUTO?	269
[:SOURce]:SAFETy:STEP<n>:IR:CHANnel[:HIGH]	270
[:SOURce]:SAFETy:STEP<n>:IR:CHANnel[:HIGH]?	270
[:SOURce]:SAFETy:STEP<n>:IR:CHANnel:LOW	270
[:SOURce]:SAFETy:STEP<n>:IR:CHANnel:LOW?	271
[:SOURce]:SAFETy:STEP<n>:IR:REF	271
[:SOURce]:SAFETy:STEP<n>:IR:REF?	271
[:SOURce]:SAFETy:STEP<n>:IR:GROUndmode	272
[:SOURce]:SAFETy:STEP<n>:IR:GROUndmode?	272

[:SOURce]:SAFETy:STEP<n>:OSC:LIMit:OPEN .....	272
[:SOURce]:SAFETy:STEP<n>:OSC:LIMit:OPEN? .....	273
[:SOURce]:SAFETy:STEP<n>:OSC:LIMit:SHORt.....	273
[:SOURce]:SAFETy:STEP<n>:OSC:LIMit:SHORt? .....	273
[:SOURce]:SAFETy:STEP<n>:OSC:CHANnel[:HIGH] .....	274
[:SOURce]:SAFETy:STEP<n>:OSC:CHANnel[:HIGH]? .....	274
[:SOURce]:SAFETy:STEP<n>:OSC:CHANnel:LOW .....	274
[:SOURce]:SAFETy:STEP<n>:OSC:CHANnel:LOW? .....	275
[:SOURce]:SAFETy:STEP<n>:OSC:CSTandard .....	275
[:SOURce]:SAFETy:STEP<n>:OSC:CSTandard? .....	275
[:SOURce]:SAFETy:STEP<n>:PAuse[:MESSAge].....	276
[:SOURce]:SAFETy:STEP<n>:PAuse[:MESSAge]? .....	276
[:SOURce]:SAFETy:STEP<n>:PAuse:UTSIgnal .....	276
[:SOURce]:SAFETy:STEP<n>:PAuse:UTSIgnal? .....	277
[:SOURce]:SAFETy:STEP<n>:PAuse:TIME[:TEST].....	277
[:SOURce]:SAFETy:STEP<n>:PAuse:TIME[:TEST]? .....	277
[:SOURce]:SAFETy:PRESet:TIME:PASS .....	278
[:SOURce]:SAFETy:PRESet:TIME:PASS? .....	278
[:SOURce]:SAFETy:PRESet:TIME:STEP .....	278
[:SOURce]:SAFETy:PRESet:TIME:STEP? .....	278
[:SOURce]:SAFETy:PRESet:RJUDgment .....	279
[:SOURce]:SAFETy:PRESet:RJUDgment? .....	279
[:SOURce]:SAFETy:PRESet:AC:FREQuency .....	279
[:SOURce]:SAFETy:PRESet:AC:FREQuency? .....	279
[:SOURce]:SAFETy:PRESet:WRANge[:AUTO] .....	280
[:SOURce]:SAFETy:PRESet:WRANge[:AUTO]? .....	280
[:SOURce]:SAFETy:PRESet:GFI[:SWITCh].....	280
[:SOURce]:SAFETy:PRESet:GFI[:SWITCh]? .....	280
[:SOURce]:SAFETy:PRESet:GCONtinuity .....	281
[:SOURce]:SAFETy:PRESet:GCONtinuity? .....	281
[:SOURce]:SAFETy:PRESet:GCONtinuity:THRrehold .....	281
[:SOURce]:SAFETy:PRESet:FAIL:OPERation .....	281
[:SOURce]:SAFETy:PRESet:FAIL:OPERation? .....	282
[:SOURce]:SAFETy:PRESet:SCREen.....	282
[:SOURce]:SAFETy:PRESet:SCREen? .....	282
[:SOURce]:SAFETy:PRESet:NUMber:PART .....	282
[:SOURce]:SAFETy:PRESet:NUMber:PART?.....	283
[:SOURce]:SAFETy:PRESet:NUMber:LOT .....	283
[:SOURce]:SAFETy:PRESet:NUMber:LOT? .....	283
[:SOURce]:SAFETy:PRESet:NUMber:SERIal .....	283

[:SOURce]:SAFEty:PRESet::NUMber:SERIal? .....284

## [:SOURce]:SAFEty:FETCh?

Returns the metered data. The < item > is character data.

Parameter: <item>[,<item>][, <item>]

The command responds the following data:

ITEM	Responding Data
STEP	The step number.
MODE	The test mode.
OMETerge	The value of output meter.
MMETerge	The value of measure meter.
RMETerge	The value of real meter.
RELapsed	The elapse time of ramp.
RLEFt	The left time of ramp.
TELApsed	The elapse time of test.
TLEFt	The left time of test.
FELapsed	The elapse time of fall.
FLEFt	The left time of fall.
DELApsed	The elapse time of dwell.
DLEFt	The left time of dwell.
CHANnel	The scan box status.

Example: SAFE:FETCh? STEP,MODE,OMET

> 1;AC;+5.000000E+02

Returns the current STEP, MODE and output value results which are STEP1, AC MODE and 0.500kV.

## [:SOURce]:SAFEty:GCONtinuity:MMETerge?

Returns the GR Cont MEASURE METER readings.

Return Parameter: <NR3>measure meter

Example: SAFE:GCON:MMET?

> +1.120000E+00

The GR Cont MEASURE METER result is 1.12Ω

---

**[[:SOURce]:SAFEty:STARt[:ONCE]**

---

Starts the test.

Parameter: NONE

Example: SAFE:STAR

---

**[[:SOURce]:SAFEty:STARt:CSTandard**

---

Starts GET Cs function of short/open circuit detection mode.

Parameter: NONE

Example: SAFE:STAR:CST

---

**[[:SOURce]:SAFEty:STARt:OFFSet**

---

Gets offset value.

Parameter: GET | OFF

Example: SAFE:STAR:OFFS GET

It means to start the function of offset value acquisition.

---

**[[:SOURce]:SAFEty:STARt:OFFSet?**

---

Returns if offset action has been done or not.

Return Parameter: 0 | 1 | 2

0 -> it means without doing zero action.

1 -> it means zero action has been done.

2 -> it means zero action is processing.

Example: SAFE:STAR:OFFS?

> 0

The main unit is without doing zero action.

---

## [:SOURce]:SAFEty:STOP

Stops the test.

Parameter: NONE

Example: SAFE:STOP

## [:SOURce]:SAFEty:STATus?

Returns the execution status of the current device.

Return Parameter: RUNNING | STOPPED

Example: SAFE:STAT?

> RUNNING

The main unit is testing now.

## [:SOURce]:SAFEty:SNUMber?

Returns the MANU step number being set in the memory.

Return Parameter: <NR1>(0 ~ 99)

Example: SAFE:SNUM?

> +2

2 MANU steps have been set in the memory.

## [:SOURce]:SAFEty:RESult:ALL[:JUDGment]?

Returns the all STEP judgment results.

Return Parameter: <NR1>result

Common judgment result code list		
Screen	Judgment Result	Code (Decimal)
PASS	PASS	116
STOP	STOP	113
Message	CAN NOT TEST	114
TEST	TESTING	115
STOP	STOP	112

GR CONT.	GR CONT.	120
GFCI	GFCI	121
POWERGND	POWER GND	122
V OVER	VOLT OVER	123
V LOW	VOLT LOW	124
INTERLOCK OPEN	INTERLOCK OPEN	125

Judgment result no good code list					
Screen	Code Meaning	AC Mode	DC Mode	IR Mode	OSC Mode
HI SET	HI SET	17	33	49	---
LO SET	LO SET	18	34	50	---
ARC	ARC	19	35	---	---
SHORT	SHORT	---	---	---	97
OPEN	OPEN	---	---	---	98

**[[:SOURce]:SAFEty:RESult:ALL:OMETerage?**

---

Returns the all OUTPUT METER readings of STEP.

Return Parameter: <NR3>output meter

Example: SAFE:RES:ALL:OMET?

> +5.000000E+02

The OUTPUT METER result is 0.500kV.

---

**[[:SOURce]:SAFEty:RESult:ALL:MMETerage?**

---

Returns the all MEASURE METER readings of STEP.

Return Parameter: <NR3>measure meter

Example: SAFE:RES:ALL:MMET?

> +5.000000E-05

The MEASURE METER result is 0.05mA.

---

---

**[[:SOURce]:SAFEty:RESult:ALL:TIME[:TEST]?**

---

Returns the needed TEST TIME of all STEP tests.

Return Parameter: <NR3>test time

Example: SAFE:RES:ALL:TIME?

> +2.000000E+00

The TEST TIME result is 2 seconds.

---

---

**[[:SOURce]:SAFEty:RESult:ALL:TIME:RAMP?**

---

Returns the needed RAMP TIME of all STEP tests.

Return Parameter: <NR3>ramp time

Example: SAFE:RES:ALL:TIME:RAMP?

> +1.500000E+00

The RAMP TIME result is 1.5 seconds.

---

---

**[[:SOURce]:SAFEty:RESult:ALL:TIME:FALL?**

---

Returns the needed FALL TIME of all STEP tests.

Return Parameter: <NR3>fall time

Example: SAFE:RES:ALL:TIME:FALL?

> +2.500000E+00

The FALL TIME result is 2.5 seconds.

---

---

**[[:SOURce]:SAFEty:RESult:ALL:TIME:DWELI?**

---

Returns the needed WAIT TIME of all STEP tests.

Return Parameter: <NR3>wait time

Example: SAFE:RES:ALL:TIME:DWEL?

> +1.000000E+00

The WAIT TIME result is 1 second.

---

---

**[[:SOURce]:SAFEty:RESult:ALL:MODE?**

Returns the test modes of all steps.

Return Parameter: AC | DC | IR | OS | PA

Example: SAFE:RES:ALL:MODE?

> DC

The MODE setting is DC MODE.

---

**[[:SOURce]:SAFEty:RESult:COMPleted?**

Returns if the device completes the execution action of all setting values.

Return Parameter: 0 | 1

Example: SAFE:RES:COMP?

> 1

The execution actions of all setting values are completed.

---

**[[:SOURce]:SAFEty:RESult:AREPort[:JUDGment]][:MESSage]**  
**(RS232 Interface only)**

Sets the auto report state of test result.

When sets as ON or 1, the test, after completing, returns the string data of "PASS" or "FAIL". When sets as OFF or 0, it will not automatically report the result.

Parameter: 0 | 1 | OFF | ON

Example: SAFE:RES:AREP ON

Sets the main unit auto report the test result after the test is completed.

---

`[[:SOURce]:SAFEty:RESult:AREPort[:JUDGment]][:MESsage]?`  
(RS232 Interface only)

---

Returns the auto reports state of test result.

Return Parameter: 0 | 1

Example: SAFE:RES:AREP?

> 1

The auto report of test result state is ON.

---

`[[:SOURce]:SAFEty:RESult:AREPort:OMETerage` (RS232 Interface only)

---

Sets the OUTPUT METER auto reports state of test result.

When sets as ON or 1, the test, after completing, returns messages which are OUTPUT

VALUE of all STEPs. If some STEPs among don't be tested, it denotes these STEPs don't have OUTPUT VALUE, returning +9.910000E+37.

When it sets as OFF or 0, it will not auto report the result.

Parameter: 0 | 1 | OFF | ON

Example: SAFE:RES:AREP:OMET ON

Sets the main unit auto report the OUTPUT METER result after the test is completed.

---

---

[[:SOURce]:SAFEty:RESult:AREPort:OMETerage? (RS232 Interface only)

---

Returns the OUTPUT METER auto reports state of test result.

Return Parameter: 0 | 1

Example: SAFE:RES:AREP:OMET?

> 1

The OUTPUT METER auto report of test result state is ON.

---

[[:SOURce]:SAFEty:RESult:AREPort:MMETerage (RS232 Interface only)

---

Sets the MEASURE METER auto reports state of test result.

When sets as ON or 1, the test, after completing, returns messages which are MEASURE

VALUE of all STEPs. If some STEPs among don't be tested, it denotes these STEPs don't have MEASURE VALUE, returning +9.910000E+37.

When it sets as OFF or 0, it will not auto report the result.

Parameter: 0 | 1 | OFF | ON

Example: SAFE:RES:AREP:MMET ON

Sets the main unit auto report the MEASURE METER result after the test is completed.

---

**[[:SOURce]:SAFEty:RESult:AREPort:MMETerage? (RS232 Interface only)**

Returns the MEASURE METER auto reports state of test result.

Return Parameter: 0 | 1

Example: SAFE:RES:AREP:MMET?

> 1

The MEASURE METER auto report of test result state is ON.

**[[:SOURce]:SAFEty:RESult[:LAST][:JUDGment]?**

Returns the judgment results of the last STEP.

Return Parameter: <NR1>result

Common judgment result code list		
Screen	Judgment Result	Code (Decimal)
PASS	PASS	116
STOP	STOP	113
Message	CAN NOT TEST	114
TEST	TESTING	115
STOP	STOP	112
GR CONT.	GR CONT.	120
GFCI	GFCI	121
POWERGND	POWER GND	122
V OVER	VOLT OVER	123
V LOW	VOLT LOW	124

Judgment result no good code list					
Screen	Code Meaning	AC Mode	DC Mode	IR Mode	OSC Mode
HI SET	HI SET	17	33	49	---
LO SET	LO SET	18	34	50	---
ARC	ARC	19	35	---	---
SHORT	SHORT	---	---	---	97
OPEN	OPEN	---	---	---	98

---

**[[:SOURce]:SAFEty:RESUlt[:LAST]:OMETerage?**

Returns the OUTPUT METER readings of the last STEP.

Return Parameter: <NR3>output meter

Example: SAFE:RES:LAST:OMET?

> +5.000000E+02

The OUTPUT METER result is 0.500kV.

---

---

**[[:SOURce]:SAFEty:RESUlt[:LAST]:MMETerage?**

Returns the MEASURE METER readings of the last STEP.

Return Parameter: <NR3>measure meter

Example: SAFE:RES:LAST:MMET?

> +5.000000E-05

The MEASURE METER result is 0.05mA.

---

---

**[[:SOURce]:SAFEty:RESUlt[:LAST]:STEP?**

Returns the last STEP.

Parameter<n>: <NR1>(1 ~ 99)

Return Parameter: <NR1>result

Example: SAFE:RES:LAST:STEP?

> 5

Return message "5" means the execution actions of last step number.

---

## [:SOURce]:SAFEty:RESult[:LAST]:MODE?

Returns the test modes of last steps.

Return Parameter: AC | DC | IR | OS | PA

Example: SAFE:RES:LAST:MODE?

> DC

The LAST MODE setting is DC MODE.

## [:SOURce]:SAFEty:RESult:STEP&lt;n&gt;[:JUDGment]?

Returns the judgment results of selected STEP.

Parameter<n>: <NR1>(1 ~ 99)

Return Parameter: <NR1>result

Example: SAFE:RES:STEP2:JUDG?

> 116

The judgment result of the second STEP is PASS.

Common judgment result code list		
Screen	Judgment Result	Code (Decimal)
PASS	PASS	116
STOP	STOP	113
Message	CAN NOT TEST	114
TEST	TESTING	115
STOP	STOP	112
GR CONT.	GR CONT.	120
GFCI	GFCI	121
POWERGND	POWER GND	122
V OVER	VOLT OVER	123
V LOW	VOLT LOW	124

Judgment result no good code list					
Screen	Code Meaning	AC Mode	DC Mode	IR Mode	OSC Mode
HI SET	HI SET	17	33	49	---
LO SET	LO SET	18	34	50	---
ARC	ARC	19	35	---	---
SHORT	SHORT	---	---	---	97
OPEN	OPEN	---	---	---	98

---

**[[:SOURce]:SAFEty:RESult:STEP<n>:OMETerage?**

---

Returns the OUTPUT METER readings of selected STEP.

Parameter<n>: <NR1>(1 ~ 99)

Return Parameter: <NR3>output meter

Example: SAFE:RES:STEP2:OMET?

> +5.000000E+02

The OUTPUT METER result of the second STEP is 0.500kV.

---

---

**[[:SOURce]:SAFEty:RESult:STEP<n>:MMETerage?**

---

Returns the MEASURE METER readings of selected STEP.

Parameter<n>: <NR1>(1 ~ 99)

Return Parameter: <NR3>measure meter

Example: SAFE:RES:STEP2:MMET?

> +5.000000E-05

The MEASURE METER result of the second STEP is 0.05mA.

---

---

**[[:SOURce]:SAFEty:STEP<n>:DELeTe**

---

Delete all setting value in selected Step.

Parameter<n>: <NR1>(1 ~ 99)

Example: SAFE:STEP1:DEL

Deleting the STEP1 setting value in the memory.

---

---

**[[:SOURce]:SAFEty:STEP<n>:SET?**

---

Returns the all setting values in selected STEP.

Parameter<n>: <NR1>(1 ~ 99)

Example: SAFE:STEP1:SET?

> 1, AC, 5.000000E+03, 6.000000E-04, 7.000000E-06, 8.000000E-03, 3.000000E+00, 1.000000E+00, 2.000000E+00, 4.000000E-04, (@(0)), (@(0))

The STEP setting value is STEP 1, AC, VOLT: 5.000kV, HIGH: 0.600mA, LOW: 0.007mA, ARC: 8.0mA, TIME: 3.0s, RAMP: 1.0s, FALL: 2.0s, REAL: 0.400mA, SCAN HI: 0, SCAN LOW: 0.

### [[:SOURce]:SAFEty:STEP<n>:MODE?

Returns the MODE in selected STEP.

Parameter<n>: <NR1>(1 ~ 99)

Return parameter: AC | DC | IR | OS | PA

Example: SAFE:STEP1:MODE?

> DC

The set mode of STEP1 is DC.

### [[:SOURce]:SAFEty:STEP<n>:AC[:LEVel]

Sets the test voltage value for ACW in selected step.

Parameter<n>: <NR1>(1 ~ 99)

Parameter: <NR1> (50 ~ 5000)

Example: SAFE:STEP1:AC:LEV 4000

Sets the test voltage value for ACW of step1 to 4000V.

### [[:SOURce]:SAFEty:STEP<n>:AC[:LEVel]?]

Returns the test voltage value for ACW in selected step.

Parameter<n>: <NR1>(1 ~ 99)

Return parameter: <NR3>

Example: SAFE:STEP1:AC:LEV?

---

> +4.000000E+03

The test voltage value for ACW of step1 is 4000V.

---

### [[:SOURce]:SAFEty:STEP<n>:AC:LIMit[:HIGH]

---

Sets the leakage current high limit for ACW in selected step.

Parameter<n>: <NR1>(1 ~ 99)

Parameter: <NRf>

Example: SAFE:STEP1:AC:LIM 0.01

Sets the leakage current high limit for ACW of step1 to 10mA.

---

### [[:SOURce]:SAFEty:STEP<n>:AC:LIMit[:HIGH]?]

---

Returns the leakage current high limit for ACW in selected step.

Parameter<n>: <NR1>(1 ~ 99)

Return parameter: <NR3>

Example: SAFE:STEP1:AC:LIM?

> +1.000000E-02

The leakage current high limit for ACW of step1 is 10mA.

---

### [[:SOURce]:SAFEty:STEP<n>:AC:LIMit:LOW]

---

Sets the leakage current low limit for ACW in selected step.

Parameter<n>: <NR1>(1 ~ 99)

Parameter: <NRf>

Example: SAFE:STEP1:AC:LIM:LOW 0.0001

Sets the leakage current low limit for ACW of step1 to 0.1mA.

---

### [[:SOURce]:SAFEty:STEP<n>:AC:LIMit:LOW?]

---

Returns the leakage current low limit for ACW in selected step.

Parameter<n>: <NR1>(1 ~ 99)

Return parameter: <NR3>

Example: SAFE:STEP1:AC:LIM:LOW?

> +1.000000E-04

The leakage current low limit for ACW of step1 is 0.1mA.

---

### [[:SOURce]:SAFEty:STEP<n>:AC:LIMit:ARC[:LEVel]

---

Sets the ARC value for ACW in selected step.

Parameter<n>: <NR1>(1 ~ 99)

Parameter: <NRf>

Example: SAFE:STEP1:AC:LIM:ARC 0.005

Sets the ARC value for ACW of step1 to 5mA.

---

### [[:SOURce]:SAFEty:STEP<n>:AC:LIMit:ARC[:LEVel]?]

---

Returns the ARC value for ACW in selected step.

Parameter<n>: <NR1>(1 ~ 99)

Return parameter: <NR3>

Example: SAFE:STEP1:AC:LIM:ARC?

> +5.000000E-03

The ARC value for ACW of step1 set is 5mA.

---

### [[:SOURce]:SAFEty:STEP<n>:AC:TIME:DWELl]

---

Sets the wait time value for ACW in selected step.

Parameter<n>: <NR1>(1 ~ 99)

Parameter: <NRf>

Example: SAFE:STEP1:AC:TIME:DWEL 0.5

Sets the wait time value for ACW of step1 to 0.5s.

---

---

**[:SOURce]:SAFEty:STEP<n>:AC:TIME:DWELI?**

---

Returns the wait time value for ACW in selected step.

Parameter<n>: <NR1>(1 ~ 99)

Return parameter: <NR3>

Example: SAFE:STEP1:AC:TIME:DWEL?

> +5.000000E-01

The wait time value for ACW of step1 set is 0.5s.

---

---

**[:SOURce]:SAFEty:STEP<n>:AC:TIME:RAMP**

---

Sets the ramp time value for ACW in selected step.

Parameter<n>: <NR1>(1 ~ 99)

Parameter: <NRf>

Example: SAFE:STEP1:AC:TIME:RAMP 0.2

Sets the ramp time value for ACW of step1 to 0.2s.

---

---

**[:SOURce]:SAFEty:STEP<n>:AC:TIME:RAMP?**

---

Returns the ramp time value for ACW in selected step.

Parameter<n>: <NR1>(1 ~ 99)

Return parameter: <NR3>

Example: SAFE:STEP1:AC:TIME:RAMP?

> +2.000000E-01

The ramp time value for ACW of step1 set is 0.2s.

---

---

**[:SOURce]:SAFEty:STEP<n>:AC:TIME[:TEST]**

---

Sets the test time value for ACW in selected step.

Parameter<n>: <NR1>(1 ~ 99)

Parameter: <NRf>

Example: SAFE:STEP1:AC:TIME 1.5

Sets the test time value for ACW of step1 to 1.5s.

---

[[:SOURce]:SAFEty:STEP<n>:AC:TIME[:TEST]?

---

Returns the test time value for ACW in selected step.

Parameter<n>: <NR1>(1 ~ 99)

Return: <NR3>

Example: SAFE:STEP1:AC:TIME?

> +1.500000E+00

The test time value for ACW of step1 set is 1.5s.

---

[[:SOURce]:SAFEty:STEP<n>:AC:TIME:FALL

---

Sets the fall time value for ACW in selected step.

Parameter<n>: <NR1>(1 ~ 99)

Parameter: <NRf>

Example: SAFE:STEP1:AC:TIME:FALL 0

Sets the fall time value for ACW of step1 to off.

---

[[:SOURce]:SAFEty:STEP<n>:AC:TIME:FALL?

---

Returns the fall time value for ACW in selected step.

Parameter<n>: <NR1>(1 ~ 99)

Return Parameter: <NR3>

Example: SAFE:STEP1:AC:TIME:FALL?

> +0.000000E+00

The fall time value for ACW of step1 set is off.

---

---

`[[:SOURce]:SAFEty:STEP<n>:AC:CHANnel[:HIGH]`

---

Sets the output channel status for ACW of scanning test high voltage.

Parameter<n>: <NR1>(1 ~ 99)

Parameter: (@(CH))

Example: SAFE:STEP1:AC:CHAN (@(1,3))

Sets the output channel for ACW of step1 to channel 1 and 3 HIGH output

Example: SAFE:STEP1:AC:CHAN (@(0))

Sets the output channel for ACW of step1 to off for all HIGH output.

---

`[[:SOURce]:SAFEty:STEP<n>:AC:CHANnel[:HIGH]?]`

---

Returns the output channel status for ACW of scanning test high voltage.

Parameter<n>: <NR1>(1 ~ 99)

Return parameter: (@(CH))

Example: SAFE:STEP1:AC:CHAN?

> @(1,3)

The output channel for ACW of step1 is set to channel 1 and 3 HIGH output.

---

---

**[[:SOURce]:SAFEty:STEP<n>:AC:CHANnel:LOW**

---

Sets the output channel status for ACW of scanning test return(low).

Parameter<n>: <NR1>(1 ~ 99)

Parameter: (@(CH))

Example: SAFE:STEP1:AC:CHAN:LOW @(2,4)

Sets the output channel for ACW of step1 to channel 2 and 4 return.

Example: SAFE:STEP1:AC:CHAN:LOW @(0)

Sets the output channel for ACW of step1 to off for all return.

---

**[[:SOURce]:SAFEty:STEP<n>:AC:CHANnel:LOW?**

---

Returns the output channel status for ACW of scanning test return(low).

Parameter<n>: <NR1>(1 ~ 99)

Return parameter: (@(CH))

Example: SAFE:STEP1:AC:CHAN:LOW?

> @(2,4)

The output channel for ACW of step1 is set to channel 2 and 4 return.

---

---

**[[:SOURce]:SAFEty:STEP<n>:AC:REF**

---

Sets the test offset value for ACW in selected step.

Parameter<n>: <NR1>(1 ~ 99)

Parameter: <NRf>

Example: SAFE:STEP1:AC:REF 0.00001

Sets the test offset value for ACW of step1 to 0.01mA.

---

---

**[[:SOURce]:SAFEty:STEP<n>:AC:REF?**

---

Returns the test offset value for ACW in selected step.

Parameter<n>: <NR1>(1 ~ 99)

Return parameter: <NR3>

Example: SAFE:STEP1:AC:REF?

> +1.000000E-05

The test offset value for ACW of step1 is 0.01mA.

---

---

**[[:SOURce]:SAFEty:STEP<n>:AC:GROUdmode**

---

Sets the ground mode for ACW in selected step to on or off.

Parameter<n>: <NR1>(1 ~ 99)

Parameter: 0 | 1 | OFF | ON

Example: SAFE:STEP1:AC:GROU 0

Sets the ground mode for ACW of step1 to off.

---

---

**[[:SOURce]:SAFEty:STEP<n>:AC:GROUdmode?**

---

Returns the ground mode status for ACW.

Parameter<n>: <NR1>(1 ~ 99)

Return parameter: 0 | 1

Example: SAFE:STEP1:AC:GROU?

> 0

The ground mode for ACW of step1 is off.

---

### [[:SOURce]:SAFETy:STEP<n>:DC[:LEVel]

---

Sets the test voltage value for DCW in selected step.

Parameter<n>: <NR1>(1 ~ 99)

Parameter: <NR1> (50 ~ 6000)

Example: SAFE:STEP2:DC:LEV 5000

Sets the test voltage value for DCW of step2 to 5000V.

---

### [[:SOURce]:SAFETy:STEP<n>:DC[:LEVel]?]

---

Returns the test voltage value for DCW in selected step.

Parameter<n>: <NR1>(1 ~ 99)

Return parameter: <NR3>

Example: SAFE:STEP2:DC:LEV?

> +5.000000E+03

The test voltage value for DCW of step2 is 5000V.

---

### [[:SOURce]:SAFETy:STEP<n>:DC:LIMit[:HIGH]

---

Sets the leakage current high limit for DCW in selected step.

Parameter<n>: <NR1>(1 ~ 99)

Parameter: <NRf>

Example: SAFE:STEP2:DC:LIM 0.009

Sets the leakage current high limit for DCW of step2 to 9mA.

---

### [[:SOURce]:SAFETy:STEP<n>:DC:LIMit[:HIGH]?]

---

Returns the leakage current high limit for DCW in selected step.

Parameter<n>: <NR1>(1 ~ 99)

Return parameter: <NR3>

Example: SAFE:STEP2:DC:LIM?

> +9.000000E-03

The leakage current high limit for DCW of step2 is 9mA.

---

### [[:SOURce]:SAFEty:STEP<n>:DC:LIMit:LOW

---

Sets the leakage current low limit for DCW in selected step.

Parameter<n>: <NR1>(1 ~ 99)

Parameter: <NRf>

Example: SAFE:STEP2:DC:LIM:LOW 0.0001

Sets the leakage current low limit for DCW of step2 to 0.1mA.

---

### [[:SOURce]:SAFEty:STEP<n>:DC:LIMit:LOW?

---

Returns the leakage current low limit for DCW in selected step.

Parameter<n>: <NR1>(1 ~ 99)

Return parameter: <NR3>

Example: SAFE:STEP2:DC:LIM:LOW?

> +1.000000E-04

The leakage current low limit for DCW of step2 is 0.1mA.

---

### [[:SOURce]:SAFEty:STEP<n>:DC:LIMit:ARC[:LEVel]

---

Sets the ARC value for DCW in selected step.

Parameter<n>: <NR1>(1 ~ 99)

Parameter: <NRf>

Example: SAFE:STEP2:DC:LIM:ARC 0.006

Sets the ARC value for DCW of step2 to 6mA.

---

---

**[[:SOURce]:SAFETy:STEP<n>:DC:LIMit:ARC[:LEVel]?]**

---

Returns the ARC value for DCW in selected step.

Parameter<n>: <NR1>(1 ~ 99)

Return parameter: <NR3>

Example: SAFE:STEP2:DC:LIM:ARC?

> +6.000000E-03

The ARC value for DCW of step2 set is 6mA.

---

---

**[[:SOURce]:SAFETy:STEP<n>:DC:TIME:DWEL]**

---

Sets the wait time value for DCW in selected step.

Parameter<n>: <NR1>(1 ~ 99)

Parameter: <NRf>

Example: SAFE:STEP2:DC:TIME:DWEL 0.8

Sets the wait time value for DCW of step2 to 0.8s.

---

---

**[[:SOURce]:SAFETy:STEP<n>:DC:TIME:DWEL?]**

---

Returns the wait time value for DCW in selected step.

Parameter<n>: <NR1>(1 ~ 99)

Return parameter: <NR3>

Example: SAFE:STEP2:DC:TIME:DWEL?

> +8.000000E-01

The wait time value for DCW of step2 set is 0.8s.

---

---

**[[:SOURce]:SAFETy:STEP<n>:DC:TIME:RAMP]**

---

Sets the ramp time value for DCW in selected step.

Parameter<n>: <NR1>(1 ~ 99)

Parameter: <NRf>

Example: SAFE:STEP2:DC:TIME:RAMP 0.3

Sets the ramp time value for DCW of step2 to 0.3s.

---

[[:SOURce]:SAFEty:STEP<n>:DC:TIME:RAMP?

---

Returns the ramp time value for DCW in selected step.

Parameter<n>: <NR1>(1 ~ 99)

Return parameter: <NR3>

Example: SAFE:STEP2:DC:TIME:RAMP?

> +3.000000E-01

The ramp time value for DCW of step2 set is 0.3s.

---

[[:SOURce]:SAFEty:STEP<n>:DC:TIME[:TEST]

---

Sets the test time value for DCW in selected step.

Parameter<n>: <NR1>(1 ~ 99)

Parameter: <NRf>

Example: SAFE:STEP2:DC:TIME 2

Sets the test time value for DCW of step2 to 2s.

---

[[:SOURce]:SAFEty:STEP<n>:DC:TIME[:TEST]?]

---

Returns the test time value for DCW in selected step.

Parameter<n>: <NR1>(1 ~ 99)

Return parameter: <NR3>

Example: SAFE:STEP2:DC:TIME?

> +2.000000E+00

The test time value for DCW of step2 set is 2s.

---

`[[:SOURce]:SAFEty:STEP<n>:DC:TIME:FALL`

---

Sets the fall time value for DCW in selected step.

Parameter<n>: <NR1>(1 ~ 99)

Parameter: <NRf>

Example: SAFE:STEP2:DC:TIME:FALL 0

Sets the fall time value for DCW of step2 to off.

---

`[[:SOURce]:SAFEty:STEP<n>:DC:TIME:FALL?`

---

Returns the fall time value for DCW in selected step.

Parameter<n>: <NR1>(1 ~ 99)

Return Parameter: <NR3>

Example: SAFE:STEP2:DC:TIME:FALL?

> +0.000000E+00

The fall time value for DCW of step2 set is off.

---

`[[:SOURce]:SAFEty:STEP<n>:DC:CHANnel[:HIGH]`

---

Sets the output channel status for DCW of scanning test high voltage.

Parameter<n>: <NR1>(1 ~ 99)

Parameter: (@(CH))

Example: SAFE:STEP2:DC:CHAN (@(1,3))

Sets the output channel for DCW of step2 to channel 1 and 3  
HIGH output

Example: SAFE:STEP2:DC:CHAN (@(0))

Sets the output channel for DCW of step2 to off for all HIGH  
output.

---

---

**[[:SOURce]:SAFEty:STEP<n>:DC:CHANnel[:HIGH]?]**

---

Returns the output channel status for DCW of scanning test high voltage.

Parameter<n>: <NR1>(1 ~ 99)

Return parameter: (@(CH))

Example: SAFE:STEP2:DC:CHAN?

> @(1,3)

The output channel for DCW of step2 is set to channel 1 and 3 HIGH output.

---

**[[:SOURce]:SAFEty:STEP<n>:DC:CHANnel:LOW]**

---

Sets the output channel status for DCW of scanning test return(low).

Parameter<n>: <NR1>(1 ~ 99)

Parameter: (@(CH))

Example: SAFE:STEP2:DC:CHAN:LOW @(2,4)

Sets the output channel for DCW of step2 to channel 2 and 4 return.

Example: SAFE:STEP2:DC:CHAN:LOW @(0)

Sets the output channel for DCW of step2 to off for all return.

---

**[[:SOURce]:SAFEty:STEP<n>:DC:CHANnel:LOW?]**

---

Returns the output channel status for DCW of scanning test return(low).

Parameter<n>: <NR1>(1 ~ 99)

Return parameter: (@(CH))

Example: SAFE:STEP2:DC:CHAN:LOW?

> @(2,4)

The output channel for DCW of step2 is set to channel 2 and 4 return.

---

**[[:SOURce]:SAFEty:STEP<n>:DC:REF**

---

Sets the test offset value for DCW in selected step.

Parameter<n>: <NR1>(1 ~ 99)

Parameter: <NRf>

Example: SAFE:STEP2:DC:REF 0.00001

Sets the test offset value for DCW of step2 to 0.01mA.

---

**[[:SOURce]:SAFEty:STEP<n>:DC:REF?**

---

Returns the test offset value for DCW in selected step.

Parameter<n>: <NR1>(1 ~ 99)

Return parameter: <NR3>

Example: SAFE:STEP2:DC:REF?

> +1.000000E-05

The test offset value for DCW of step2 is 0.01mA.

---

**[[:SOURce]:SAFEty:STEP<n>:DC:GROUdmode**

---

Sets the ground mode for DCW in selected step to on or off.

Parameter<n>: <NR1>(1 ~ 99)

Parameter: 0 | 1 | OFF | ON

Example: SAFE:STEP2:DC:GROU 0

Sets the ground mode for DCW of step2 to off.

---

---

`[[:SOURce]:SAFEty:STEP<n>:DC:GROUndmode?`

---

Returns the ground mode status for DCW in selected step.

Parameter<n>: <NR1>(1 ~ 99)

Return parameter: 0 | 1

Example: SAFE:STEP2:DC:GROU?

> 0

The ground mode for DCW of step2 is off.

---

`[[:SOURce]:SAFEty:STEP<n>:IR[:LEVel]`

---

Sets the test voltage value for IR in selected step.

Parameter<n>: <NR1>(1 ~ 99)

Parameter: <NR1> (50 ~ 1000)

Example: SAFE:STEP3:IR:LEV 500

Sets the test voltage value for IR of step3 to 500V.

---

`[[:SOURce]:SAFEty:STEP<n>:IR[:LEVel]?`

---

Returns the test voltage value for IR in selected step.

Parameter<n>: <NR1>(1 ~ 99)

Return parameter: <NR3>

Example: SAFE:STEP3:IR:LEV?

> +5.000000E+02

The test voltage value for IR of step3 is 500V.

---

`[[:SOURce]:SAFEty:STEP<n>:IR:LIMit:HIGH`

---

Sets the high limit value for IR in selected step.

Parameter<n>: <NR1>(1 ~ 99)

Parameter: <NRf>

---

Example: SAFE:STEP3:IR:LIM:HIGH 50000000000

Sets the high limit value for IR of step3 to 50GΩ.

---

[[:SOURce]:SAFEty:STEP<n>:IR:LIMit:HIGH?

---

Returns the high limit value for IR in selected step.

Parameter<n>: <NR1>(1 ~ 99)

Return parameter: <NR3>

Example: SAFE:STEP3:IR:LIM:HIGH?

> +5.000000E+10

The high limit value for IR of step3 is 50GΩ.

---

[[:SOURce]:SAFEty:STEP<n>:IR:LIMit[:LOW]

---

Sets the low limit value for IR in selected step.

Parameter<n>: <NR1>(1 ~ 99)

Parameter: <NRf>

Example: SAFE:STEP3:IR:LIM 100000

Sets the low limit value for IR of step3 to 0.1MΩ.

---

[[:SOURce]:SAFEty:STEP<n>:IR:LIMit[:LOW]?]

---

Returns the low limit value for IR in selected step.

Parameter<n>: <NR1>(1 ~ 99)

Return parameter: <NR3>

Example: SAFE:STEP3:IR:LIM?

> +1.000000E+05

The low limit value for IR of step3 is 0.1MΩ.

---

---

**[[:SOURce]:SAFEty:STEP<n>:IR:TIME:DWEL]**

---

Sets the wait time value for IR in selected step.

Parameter<n>: <NR1>(1 ~ 99)

Parameter: <NRf>

Example: SAFE:STEP3:IR:TIME:DWEL 0.9

Sets the wait time value for IR of step3 to 0.9s.

---

---

**[[:SOURce]:SAFEty:STEP<n>:IR:TIME:DWEL?]**

---

Returns the wait time value for IR in selected step.

Parameter<n>: <NR1>(1 ~ 99)

Return parameter: <NR3>

Example: SAFE:STEP3:IR:TIME:DWEL?

> +9.000000E-01

The wait time value for IR of step3 set is 0.9s.

---

---

**[[:SOURce]:SAFEty:STEP<n>:IR:TIME:RAMP]**

---

Sets the ramp time value for IR in selected step.

Parameter<n>: <NR1>(1 ~ 99)

Parameter: <NRf>

Example: SAFE:STEP3:IR:TIME:RAMP 0.5

Sets the ramp time value for IR of step3 to 0.5s.

---

---

**[[:SOURce]:SAFEty:STEP<n>:IR:TIME:RAMP?]**

---

Returns the ramp time value for IR in selected step.

Parameter<n>: <NR1>(1 ~ 99)

Return parameter: <NR3>

Example: SAFE:STEP3:IR:TIME:RAMP?

---

> +5.000000E-01

The ramp time value for IR of step3 set is 0.5s.

---

### [[:SOURce]:SAFETy:STEP<n>:IR:TIME[:TEST]

---

Sets the test time value for IR in selected step.

Parameter<n>: <NR1>(1 ~ 99)

Parameter: <NRf>

Example: SAFE:STEP3:IR:TIME 5

Sets the test time value for IR of step3 to 5s.

---

### [[:SOURce]:SAFETy:STEP<n>:IR:TIME[:TEST]?]

---

Returns the test time value for IR in selected step.

Parameter<n>: <NR1>(1 ~ 99)

Return parameter: <NR3>

Example: SAFE:STEP3:IR:TIME?

> +5.000000E+00

The test time value for IR of step3 set is 5s.

---

### [[:SOURce]:SAFETy:STEP<n>:IR:TIME:FALL

---

Sets the fall time value for IR in selected step.

Parameter<n>: <NR1>(1 ~ 99)

Parameter: <NRf>

Example: SAFE:STEP3:IR:TIME:FALL 0

Sets the fall time value for IR of step3 to off.

---

### [[:SOURce]:SAFETy:STEP<n>:IR:TIME:FALL?

---

Returns the fall time value for IR in selected step.

Parameter<n>: <NR1>(1 ~ 99)

Return Parameter: <NR3>

Example: SAFE:STEP3:IR:TIME:FALL?

> +0.000000E+00

The fall time value for IR of step3 set is off.

---

### [[:SOURce]:SAFEty:STEP<n>:IR:RANGe[:UPPer]

---

It is in accordance with users' input current value to select the range which is upper than the current that can be measured.

Parameter<n>: <NR1>(1 ~ 99)

Parameter: <NRf>

Example: SAFE:STEP3:IR:RANG 0.0005

The IR measured current value of step3 is set to 500uA. Thus, meanwhile the selected IR range upper than the current can be measured is 5mA.

---

### [[:SOURce]:SAFEty:STEP<n>:IR:RANGe[:UPPer]?]

---

Returns the range for IR in selected step.

Parameter<n>: <NR1>(1 ~ 99)

Return parameter: <NR3>

Example: SAFE:STEP3:IR:RANG?

> +5.000000E-03

The setting range for IR of step3 is 5mA.

---

### [[:SOURce]:SAFEty:STEP<n>:IR:RANGe:LOWer]

---

It is in accordance with users' input current value to select the range which is lower than the current that can be measured.

Parameter<n>: <NR1>(1 ~ 99)

Parameter: <NRf>

Example: SAFE:STEP3:IR:RANG:LOW 0.0005

The IR measured current value of step3 is set to 500uA. Thus, meanwhile the selected IR range lower than the current can be measured is 500uA.

---

### [[:SOURce]:SAFEty:STEP<n>:IR:RANGe:LOWer?

---

Returns the range for IR in selected step.

Parameter<n>: <NR1>(1 ~ 99)

Return parameter: <NR3>

Example: SAFE:STEP3:IR:RANG:LOW?

> +5.000000E-04

The setting range for IR of step3 is 500uA.

---

### [[:SOURce]:SAFEty:STEP<n>:IR:RANGe:AUTO

---

Sets the auto range status for IR in selected step.

Parameter<n>: <NR1>(1 ~ 99)

Parameter: 0 | 1 | OFF | ON

Example: SAFE:STEP3:IR:RANG:AUTO 1

Sets the auto range for IR of step3 to on.

---

### [[:SOURce]:SAFEty:STEP<n>:IR:RANGe:AUTO?

---

Returns the auto range status for IR in selected step.

Parameter<n>: <NR1>(1 ~ 99)

Return parameter: 0 | 1

Example: SAFE:STEP3:IR:RANG:AUTO?

> 1

The auto range status for IR of step3 is on.

---

---

**[[:SOURce]:SAFEty:STEP<n>:IR:CHANnel[:HIGH]**

---

Sets the output channel status for IR of scanning test high voltage.

Parameter<n>: <NR1>(1 ~ 99)

Parameter: (@(CH))

Example: SAFE:STEP3:IR:CHAN (@(1,3))

Sets the output channel for IR of step3 to channel 1 and 3

HIGH output

Example: SAFE:STEP3:IR:CHAN (@(0))

Sets the output channel for IR of step3 to off for all HIGH output.

---

**[[:SOURce]:SAFEty:STEP<n>:IR:CHANnel[:HIGH]?]**

---

Returns the output channel status for IR of scanning test high voltage.

Parameter<n>: <NR1>(1 ~ 99)

Return parameter: (@(CH))

Example: SAFE:STEP3:IR:CHAN?

> @(1,3)

The output channel for IR of step3 is set to channel 1 and 3 HIGH output.

---

**[[:SOURce]:SAFEty:STEP<n>:IR:CHANnel:LOW]**

---

Sets the output channel status for IR of scanning test return (low).

Parameter<n>: <NR1>(1 ~ 99)

Parameter: (@(CH))

Example: SAFE:STEP3:IR:CHAN:LOW @(2,4)

Sets the output channel for IR of step3 to channel 2 and 4 return.

---

Example: SAFE:STEP3:IR:CHAN:LOW (@(0))

Sets the output channel for IR of step3 to off for all return.

---

[[:SOURce]:SAFEty:STEP<n>:IR:CHANnel:LOW?

---

Returns the output channel status for IR of scanning test return (low).

Parameter<n>: <NR1>(1 ~ 99)

Return parameter: (@(CH))

Example: SAFE:STEP3:IR:CHAN:LOW?

> (@(2,4))

The output channel for IR of step3 is set to channel 2 and 4 return.

---

[[:SOURce]:SAFEty:STEP<n>:IR:REF

---

Sets the test offset value for IR in selected step.

Parameter<n>: <NR1>(1 ~ 99)

Parameter: <NRf>

Example: SAFE:STEP3:IR:REF 100000

Sets the test offset value for IR of step3 to 0.1MΩ.

---

[[:SOURce]:SAFEty:STEP<n>:IR:REF?

---

Returns the test offset value for IR in selected step.

Parameter<n>: <NR1>(1 ~ 99)

Return parameter: <NR3>

Example: SAFE:STEP3:IR:REF?

> +1.000000E+05

The test offset value for IR of step3 is 0.1MΩ.

---

---

**[[:SOURce]:SAFEty:STEP<n>:IR:GROUndmode**

Sets the ground mode for IR in selected step on or off.

Parameter<n>: <NR1>(1 ~ 99)

Parameter: 0 | 1 | OFF | ON

Example: SAFE:STEP3:IR:GROU 0

Sets the ground mode for IR of step3 off.

---

**[[:SOURce]:SAFEty:STEP<n>:IR:GROUndmode?**

Returns the ground mode status for IR in selected step.

Parameter<n>: <NR1>(1 ~ 99)

Return parameter: 0 | 1

Example: SAFE:STEP3:IR:GROU?

> 0

The ground mode for IR of step3 is off.

---

**[[:SOURce]:SAFEty:STEP<n>:OSC:LIMit:OPEN**

Sets the percentage of OSC in selected step judged by open circuit as detecting short/open circuit.

Parameter<n>: <NR1>(1 ~ 99)

Parameter: <NRf>

Example: SAFE:STEP4:OSC:LIM:OPEN 0.4

Sets the percentage of OSC of step4 to 40% by open circuit as detecting short/open circuit.

---

---

**[[:SOURce]:SAFEty:STEP<n>:OSC:LIMit:OPEN?**

Returns the percentage of OSC in selected step judged by open circuit as detecting short/open circuit.

Parameter<n>: <NR1>(1 ~ 99)

Return parameter: <NR3>

Example: SAFE:STEP4:OSC:LIM:OPEN?

> +4.000000E-01

The percentage of OSC of step4 is 40% by open circuit as detecting short/open circuit.

---

**[[:SOURce]:SAFEty:STEP<n>:OSC:LIMit:SHORT**

Sets the percentage off OSC in selected step is judged by short circuit as detecting short/open circuit.

Parameter<n>: <NR1>(1 ~ 99)

Parameter: <NRf>

Example: SAFE:STEP4:OSC:LIM:SHOR 3

Sets the percentage off OSC of step4 is 300% by short circuit as detecting short/open circuit.

---

**[[:SOURce]:SAFEty:STEP<n>:OSC:LIMit:SHORT?**

Returns the percentage off OSC in selected step judged by short circuit as detecting short/open circuit.

Parameter<n>: <NR1>(1 ~ 99)

Example: SAFE:STEP4:OSC:LIM:SHOR?

> +3.000000E+00

The percentage off OSC of step4 is 300% by short circuit as detecting short/open circuit.

---

---

**[[:SOURce]:SAFEty:STEP<n>:OSC:CHANnel[:HIGH]**

Sets the output channel status for OSC of scanning test high voltage.

Parameter<n>: <NR1>(1 ~ 99)

Parameter: (@(CH))

Example: SAFE:STEP4:OSC:CHAN (@(1))

Sets the output channel for OSC of step4 to channel 1 HIGH output

Example: SAFE:STEP4:OSC:CHAN (@(0))

Sets the output channel for OSC of step4 off for all HIGH output.

---

**[[:SOURce]:SAFEty:STEP<n>:OSC:CHANnel[:HIGH]?]**

Returns the output channel status for OSC of scanning test high voltage.

Parameter<n>: <NR1>(1 ~ 99)

Return parameter: (@(CH))

Example: SAFE:STEP4:OSC:CHAN?

> @(1))

The output channel for OSC of step4 is set to channel 1 HIGH output.

---

**[[:SOURce]:SAFEty:STEP<n>:OSC:CHANnel:LOW]**

Sets the output channel status for OSC of scanning test return(low).

Parameter<n>: <NR1>(1 ~ 99)

Parameter: (@(CH))

Example: SAFE:STEP4:OSC:CHAN:LOW (@(2))

Sets the output channel for OSC of step4 to channel 2 return.

Example: SAFE:STEP4:OSC:CHAN:LOW (@(0))

Sets the output channel for OSC of step4 off for all return.

---

### [[:SOURce]:SAFEty:STEP<n>:OSC:CHANnel:LOW?

---

Returns the output channel status for OSC of scanning test return(low).

Parameter<n>: <NR1>(1 ~ 99)

Return parameter: (@(CH))

Example: SAFE:STEP4:OSC:CHAN:LOW?

> (@(2))

The output channel for OSC of step4 is set to channel 2 return.

---

### [[:SOURce]:SAFEty:STEP<n>:OSC:CSTandard

---

Sets the Cs value of the selected STEP range under short/open detection mode.

Parameter<n>: <NR1>(1 ~ 99)

Parameter: <NR1>(Range:1~3) , <NRf>(Cs)

Example: SAFE:STEP4:OSC:CST 1,0.000000001

It indicates range 1 Cs value of the main unit STEP4 under short/open detection mode is 1nF.

Note: The current ratio of Cs to STD# is 1uA = 7.96pF.

---

### [[:SOURce]:SAFEty:STEP<n>:OSC:CSTandard?

---

Returns the Cs value of the selected STEP range under short/open detection mode.

Parameter<n>: <NR1>(1 ~ 99)

Return parameter: <NR3>

Example: SAFE:STEP4:OSC:CST?

> +1.000000E-09

The Cs value for OSC of step4 is 1nF.

---

### [[:SOURce]:SAFEty:STEP<n>:PAuse[:MESSAge]

---

Sets the string of message in selected step.

Parameter<n>: <NR1>(1 ~ 99)

Parameter: <String>

Example: SAFE:STEP5:PA:MESS GWinstek

The message string for PA of step5 is set to GWInstek.

---

### [[:SOURce]:SAFEty:STEP<n>:PAuse[:MESSAge]?]

---

Returns the string of message in selected step.

Parameter<n>: <NR1>(1 ~ 99)

Return parameter: <String>

Example: SAFE:STEP5:PA:MESS?

> GWInstek

The message string of step5 is "GWInstek".

---

### [[:SOURce]:SAFEty:STEP<n>:PAuse:UTSIgnal]

---

Sets the status of UNDER TEST SIGNAL in selected step.

Parameter<n>: <NR1>(1 ~ 99)

Parameter: 0 | 1 | OFF | ON

Example: SAFE:STEP5:PA:UTSI ON

Sets the status of UNDER TEST SIGNAL of step5 to ON.

---

[[:SOURce]:SAFEty:STEP<n>:PAuse:UTSIgnal?

---

Returns the status of UNDER TEST SIGNAL in selected step.

Parameter<n>: <NR1>(1 ~ 99)

Return parameter: 0 | 1

Example: SAFE:STEP5:PA:UTSI?

> 1

The status of UNDER TEST SIGNAL of step5 is on.

---

[[:SOURce]:SAFEty:STEP<n>:PAuse:TIME[:TEST]

---

Sets the test needed time for PA in selected step.

Parameter<n>: <NR1>(1 ~ 99)

Parameter: <NRf>

Example: SAFE:STEP5:PA:TIME 5

Sets the test needed time for PA of step5 to 5sec.

---

[[:SOURce]:SAFEty:STEP<n>:PAuse:TIME[:TEST]?

---

Returns the test needed time for PA in selected step.

Parameter<n>: <NR1>(1 ~ 99)

Return paramter: <NR3>

Example: SAFE:STEP5:PA:TIME?

> +5.000000E+00

The test needed time for PA of step5 is 5sec.

---

---

**[[:SOURce]:SAFEty:PRESet:TIME:PASS**

---

Sets the buzzer sound continuous time when pass.

Parameter: <NRf>(0.2 ~ 999.9)

Example: SAFE:PRESet:TIME:PASS 1

Sets the buzzer sound continuous time when pass to 1 sec.

---

---

**[[:SOURce]:SAFEty:PRESet:TIME:PASS?**

---

Returns the buzzer sound continuous time when pass.

Return parameter: <NR3>

Example: SAFE:PRESet:TIME:PASS?

> +1.000000E+00

The buzzer sound continuous time when pass is 1 sec.

---

---

**[[:SOURce]:SAFEty:PRESet:TIME:STEP**

---

Sets the interval time between step and step.

Parameter: <NRf>(0.0 ~ 999.9) | KEY

Example: SAFE:PRESet:TIME:STEP 0.5

Sets the interval time between step and step to 0.5sec.

---

---

**[[:SOURce]:SAFEty:PRESet:TIME:STEP?**

---

Returns the interval time between step and step.

Return parameter: <NR3>

Example: SAFE:PRESet:TIME:STEP?

> +5.000000E-01

The Interval time between step and step is 0.5sec.

---

---

**[[:SOURce]:SAFEty:PRESet:RJUDgment**

---

Sets the status of ramp judgment.

Parameter: 0 | 1 | OFF | ON

Example: SAFE:PRES:RJUD ON

Sets the status of ramp judgment on.

---

---

**[[:SOURce]:SAFEty:PRESet:RJUDgment?**

---

Returns the status of ramp judgment.

Return parameter: 0 | 1

Example: SAFE:PRES:RJUD?

> 1

The status of ramp judgment is on.

---

---

**[[:SOURce]:SAFEty:PRESet:AC:FREQuency**

---

Sets the output voltage frequency when testing ACW.

Parameter: 50 | 60

Example: SAFE:PRES:AC:FREQ 50

Sets the output voltage frequency to 50Hz.

---

---

**[[:SOURce]:SAFEty:PRESet:AC:FREQuency?**

---

Returns the output voltage frequency when testing ACW

Return parameter: <NR3>

Example: SAFE:PRES:AC:FREQ?

> +5.000000E+01

The output voltage frequency when testing ACW is 50Hz.

---

---

`[[:SOURce]:SAFEty:PRESet:WRANge[:AUTO]`

---

Sets the auto range function for DCW on or off.

Parameter: 0 | 1 | OFF | ON

Example: SAFE:PRES:WRAN 1

Sets the auto range function for DCW on.

---

`[[:SOURce]:SAFEty:PRESet:WRANge[:AUTO]?`

---

Returns the status of auto range function for DCW.

Return parameter: 0 | 1

Example: SAFE:PRES:WRAN?

> 1

The status of auto range function for DCW is on.

---

`[[:SOURce]:SAFEty:PRESet:GFI[:SWITCh]`

---

Sets the GFCI switch on or off.

Parameter: 0 | 1 | OFF | ON

Example: SAFE:PRES:GFI 0

Sets the GFCI switch off.

---

`[[:SOURce]:SAFEty:PRESet:GFI[:SWITCh]?`

---

Returns the GFCI switch status.

Return parameter: 0 | 1

Example: SAFE:PRES:GFI?

> 0

The GFCI switch status is off.

---

---

**[[:SOURce]:SAFEty:PRESet:GCONtinuity**

---

Sets the GR CONT. function on or off.

Parameter: 0 | 1 | OFF | ON | <NRf>(0.2 ~ 999.9)

Example: SAFE:PRES:GCON ON

Sets the GR CONT. function on (use key method).

Example: SAFE:PRES:GCON 2

Sets the GR CONT. function on and 2sec (use time method).

---

---

**[[:SOURce]:SAFEty:PRESet:GCONtinuity?**

---

Returns the status of GR CONT. function.

Return parameter: 0 | 1 | <NR3>

Example: SAFE:PRES:GCON?

> OFF

The GR CONT. function is off.

---

---

**[[:SOURce]:SAFEty:PRESet:GCONtinuity:THRrehold**

---

Sets the GR CONT. function threshold resistor.

Parameter: <NR1>(1 ~ 50)

Example: SAFE:PRES:GCON:THR 3

Sets the GR CONT. threshold resistor 3Ω

---

---

**[[:SOURce]:SAFEty:PRESet:FAIL:OPERation**

---

Sets the AFTER FAIL parameter to stop or continue or restart.

Parameter: STOP | CONTInue | REStart

Example: SAFE:PRES:FAIL:OPER CONT

Sets the AFTER FAIL parameter to continue.

---

---

**[[:SOURce]:SAFEty:PRESet:FAIL:OPERation?**

---

Returns the status of AFTER FAIL parameter.

Return parameter: STOP | CONTINUE | RESTART

Example: SAFE:PRES:FAIL:OPER?

> CONTINUE

The AFTER FAIL parameter is continue.

---

---

**[[:SOURce]:SAFEty:PRESet:SCREen**

---

Sets the display the function of test screen on or off or stat.

Parameter: 0 | 1 | 2 | OFF | ON | STAT

Example: SAFE:PRES:SCRE ON

Sets the display the function of test screen on.

---

---

**[[:SOURce]:SAFEty:PRESet:SCREen?**

---

Returns the display the function of test screen.

Return parameter: 0 | 1 | 2

Example: SAFE:PRES:SCRE?

> 1

The display the function of test screen is on.

---

---

**[[:SOURce]:SAFEty:PRESet:NUMber:PART**

---

Sets the part number of the product.

Parameter: "String",", max length 13 characters

Example: SAFE:PRES:NUM:PART "9500"

Sets the part number of the product to "9500".

---

---

**[[:SOURce]:SAFEty:PRESet:NUMber:PART?**

---

Returns the part number of the product.

Return parameter: "String", max length 13 characters

Example: SAFE:PRESet:NUM:PART?

> "9500"

The part number of the product is "9500".

---

---

**[[:SOURce]:SAFEty:PRESet:NUMber:LOT**

---

Sets the lot number of the product.

Parameter: "String", max length 13 characters

Example: SAFE:PRESet:NUM:LOT "0013"

Sets the lot number of the product to "0013".

---

---

**[[:SOURce]:SAFEty:PRESet:NUMber:LOT?**

---

Returns the lot number of the product.

Return parameter: "String", max length 13 characters

Example: SAFE:PRESet:NUM:LOT?

> "0013"

The lot number of the product is "0013".

---

---

**[[:SOURce]:SAFEty:PRESet:NUMber:SERial**

---

Sets the serial number of the product.

Parameter: "String", max length 13 characters >

Example: SAFE:PRESet:NUM:SER "GW9500\*\*\*\*"

Sets the serial number of the product to "GW9500\*\*\*\*".

---

`[:SOURce]:SAFEty:PRESet:NUMber:SERial?`

---

Returns the serial number of the product.

Return parameter: "String", max length 13 characters

Example: SAFE:PRE:NUM:SER?

> "GW9500\*\*\*"

The serial number of the product is "GW9500\*\*\*".

---

## Common Commands

---

*CLS .....	285
*ESE.....	285
*ESE? .....	286
*ESR?.....	286
*SRE .....	286
*SRE?.....	286
*STB? .....	287
*OPC .....	287
*OPC? .....	287
*PSC .....	287
*PSC? .....	287
*RST .....	287
*IDN?.....	288
*SAV.....	288
*RCL.....	288

### \*CLS

---

Clears the Event Status Register (Error Queue, Operation Event Status, Questionable Event Status, Standard Event Status Register).

---

### \*ESE

---

Sets the Standard Event Status of Enable Register value.

Parameter: 0 ~ 255

Example: \*ESE 32

Sets the standard event status of enable register value to 32 (00100000).

---

**\*ESE?**

---

Returns the Standard Event Status of Enable Register value.

Return parameter: <NR1>(0 ~ 255)

Example: \*ESE?

> 32

The standard event status of enable register value is 32 (00100000).

---

**\*ESR?**

---

Returns the Standard Event Register value.

Return parameter: <NR1>(0 ~ 255)

Example: \*ESR?

> 49

The standard event register value is 49 (00110001).

---

**\*SRE**

---

Sets the Service Request Status of Enable Register value.

Parameter: <NR1>(0 ~ 255)

Example: \*SRE 32

Sets the service request status of enable register value to 32 (00100000).

---

**\*SRE?**

---

Returns the Service Request Status of Enable Register value

Return parameter: <NR1>(0 ~ 255)

Example: \*SRE?

> 32

The service request status of enable register value is 32 (00100000).

---

---

**\*STB?**

---

The controller is for reading status bit register value.

Return parameter:<NR1>(0 ~ 255)

---

---

**\*OPC**

---

Operation is completed command.

---

---

**\*OPC?**

---

Operation complete query command.

The output format is ASCII character " 1 ".

---

---

**\*PSC**

---

Power on status clear command.

Parameter: 0 | 1

---

---

**\*PSC?**

---

Returns the Power on status clear.

Return parameter: 0 | 1

---

---

**\*RST**

---

The device reset command available for RS232 interface only.

---

**\*IDN?**

---

Returns the manufacturer, model No., serial number and system version number.

Example: \*IDN?

> GWInstek,GPT9513,GDM123456,1.00

---

**\*SAV**

---

This command is to save the current status into memory.

Parameter: <NR1> (1 ~ 99)

Example: \*SAV 5

> Saves the AUTO 0 status to the designated AUTO 5.

Note: User can only designate the target group, whereas the source group is always fixed in AUTO 0.

---

**\*RCL**

---

This command is to recall the saved status.

Parameter: <NR1> (1 ~ 99)

Example: \*RCL 4

> Recalls the designated AUTO 4 status to the AUTO 0.

Note: User can only designate the source group, whereas the target group is always fixed in AUTO 0.

---

# A

## PPENDIX

### Fuse Replacement

---

Steps

1. Turn the instrument off.

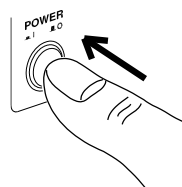

2. Remove the power cord.

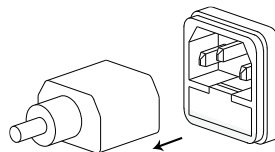

3. Remove the fuse socket using a flat screwdriver.

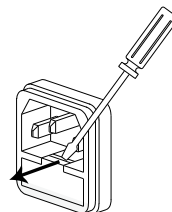

4. Replace the fuse in the fuse holder.

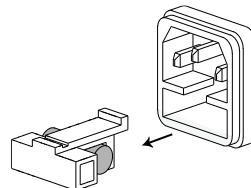

---

Fuse Rating

T 4A, 250V

## Test Errors

The following test error messages highlighted in red may appear on the GPT-9500 display when completing a running test.

---

Error Messages	Description
HI SET	Test result is beyond the HI SET value
LO SET	Test result is below the LOW SET value
V OVER	Measured voltage is beyond the set value by 1.2 times
V LOW	Measured voltage is below 10V
ARC	ARC abnormality detected
GFCI	Ground fault circuit interrupt
OPEN	Open short-circuit detected open
SHORT	Open short-circuit detected short
POWER GND	Power cord fail to connect with earth ground
GR CONT	Ground continuity check is beyond the threshold value

## Factory Default Parameters

### ITEM LIST

Manu Step	All set DCW/50V
AUTO Step	All Clear

### SYSTEM

Backlight	60%
Beep	Large
Key Sound	Medium
Language	English

### TEST

Control By	Front
InterLock	ON
PowerGND Check	ON
Wait time Mode	Ramp
ARC Mode	Normal
Safety Display	ON
Double Action	OFF
Start Click(1 Sec)	ON
ACW Frequency	60Hz
Pass Hold	0.5s
GFCI	ON
Auto Range	ON
Screen	ON
Ramp Judg	ON
Step By Step(scan)	OFF

### Interface

Interface	RS232
Baudrate	115200
Parity	OFF
EndOfLine	CR+LF
Identity	Default
Auto Save(PARA)	OFF

## Status System

The diagram below is a description of the status system

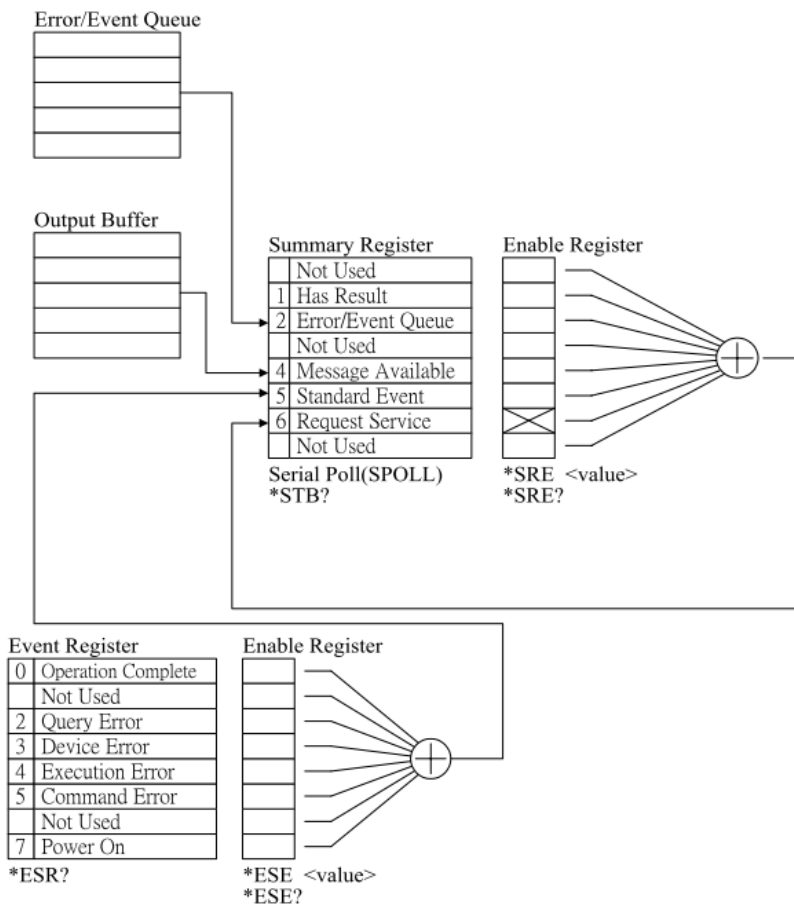

## GPT-9500 Specifications

The specifications apply when the GPT-9500 is powered on for at least 30 minutes at 15°C~35°C.

### Specifications

#### General

DISPLAY	4.3" color LCD with 480x272 resolution
MEMORY	AUTO/MANU mode 500 memory blocks total
POWER SOURCE	AC 100V~240V ± 10%, 50Hz/60Hz
ACCESSORIES	Power cord x1, Quick Start Guide x1 User Manual x1(CD) GHT-115 x1 * GHT-116B x1 * GHT-116R x8 *
DIMENSIONS & WEIGHT	Approx. 320(W) x 120(H) x435(D) / 11kg

\* Please refer to the packing list since the accessories may vary.

#### Environment

Range	Temperature	Humidity
Warranty	15°C ~ 35°C	≤70% (No condensation)
Operation	0°C ~ 40°C	≤70% (No condensation)
Storage	-10°C ~ 70°C	≤85% (No condensation)
Installation Location	Indoors at an amplitude of up to 2000m.	

**AC Withstanding Voltage**

Output Voltage Range	0.050kV~ 5.000kV <sup>1</sup>
Output Voltage Resolution	1V
Output Voltage Accuracy	(1% of setting +5V) with no load
Maximum Rated Load	150VA (5kV/30mA)
Maximum Rated Current	30mA 0.001mA~10mA(0.05kV~0.5kV) 0.001mA~30mA(0.5kV~ 5kV)
Output Voltage Waveform	Sine wave
Voltage Regulation	± (1% +5V)[Maximum rated load ->no load]
Frequency	50 Hz / 60 Hz
Voltmeter Accuracy	± (1% of reading+ 5 V)
Current Measurement Range	0.001mA~30.00mA
Current Best Resolution	1uA (0.001mA ~9.999mA) 10uA(10.00mA~30.00mA)
Current Measurement Accuracy	± (1.5% of reading+50uA) <sup>3</sup>
Current Offset	80uA Maximum
Judgment Accuracy	± (3% of setting+30uA) <sup>3</sup>
ARC DETECT	YES
RAMP TIME (Rise Time)	0.1~999.9s
FALL Time	OFF~999.9s
WAIT Time	OFF~999.9s
TIMER (Test Time)	CONT <sup>2</sup> ,0.3s~999.9s
TIMER Accuracy	+/- (100ppm+20ms)
GND	ON/OFF

<sup>1</sup> At least 0.3 seconds is needed to reach a set voltage of 50V/10mA.

<sup>2</sup> When setting greater than 100VA, the maximum test time is 600 seconds followed by the identical rest time. Plus, overheat protection will be activated and thus output will be stopped when test time is over 600 seconds.

<sup>3</sup> When scan channel is activated, it is required to add 15uA for each channel.

## DC Withstanding Voltage

Output Voltage Range	0.050kV~ 6.000kV <sup>1</sup>
Output Voltage Resolution	1V
Output Voltage Accuracy	±(1% of setting +5V) With no load
Maximum Rated Load	50W(5kV/10mA)
Maximum Rated Current	10mA 0.001mA~2mA(0.05kV<=V<=0.5kV) 0.001mA~10mA(0.5kV<V<=6kV)
Voltmeter Accuracy	± (1% of reading+ 5 V)
Voltage Regulation	± (1% +5V)[Maximum rated load ->no load]
Current Measurement Range	0.001mA-10.00mA
Current Best Resolution	0.1uA (0.1uA~999.9uA) 1uA (0.001mA~9.999mA) 10uA(10.00mA)
Current Measurement Accuracy	±(1 % of reading+ 3uA) , I< 1mA ±(1 % of reading+ 10uA), I>= 1mA <sup>3</sup>
Current Offset	5uA Maximum
Judgment Valid Range (DCW)	± (3% of setting+30uA) <sup>3</sup>
ARC DETECT	YES
RAMP TIME (Rise Time)	0.1~999.9s
FALL Time	OFF~999.9s
WAIT Time	OFF~999.9s
TIMER (Test Time)	CONT <sup>2</sup> ,0.3s~999.9s
TIMER Accuracy	+/(100ppm+20ms)
GND mode	ON/OFF
Maximum Capacitive Load	1uF
DC Mode <sup>4</sup>	

<sup>1</sup> At least 0.3 seconds is needed to reach a set voltage of 50V/2mA.

<sup>2</sup> When setting greater than 40VA, the maximum test time is 600 seconds followed by the identical rest time. Plus, overheat protection will be activated and thus output will be stopped when test time is over 600 seconds.

<sup>3</sup> When scan channel is activated, it is required to add 2uA for each channel.

<sup>4</sup> Refer to the **Table 1** for more details.

**Insulation Resistance Test**

Output Voltage	0.050kV~1.000kV	
Output Voltage Resolution	1V	
Output Voltage Accuracy	±(1% of setting +5V) with no load	
Resistance Measurement Range	0.1MΩ~10GΩ <sup>1</sup>	
Test Voltage	Measurement Range	Accuracy
50V≤V<500V	0.1MΩ~10MΩ	±(5% of reading + 3% of fs)
	10.1MΩ~50MΩ	±(5% of reading + 1% of fs)
	50.1MΩ~2GΩ	±(10% of reading + 1% of fs)
500V≤V≤1000V	0.1MΩ~10MΩ	±(5% of reading + 3% of fs)
	10.1MΩ~500MΩ	±(5% of reading + 1% of fs)
	500.1MΩ~10GΩ	±(10% of reading + 1% of fs)
Voltage regulation	± (1% +5V) [Maximum rated load ->no load]	
Voltmeter Accuracy	±(1% of reading +5V)	
Short-Circuit Current	10mA max.	
Output Impedance	2kΩ	
RAMP TIME (Rise Time)	0.1~999.9s	
FALL Time	OFF~999.9s	
WAIT Time	OFF~999.9s	
TIMER (Test Time)	0.3s~999.9s <sup>2</sup>	
GND mode	ON/OFF <sup>2</sup>	

NOTE: It is required to implement GND OFFSET action when IR Ground Mode is On.

- <sup>1</sup> When IR Ground Mode is On, Test Voltage <100V , the maximum 1Gohm measurement range is guaranteed
- <sup>2</sup> When IR Ground Mode is On, test time must be greater than 1 second.

**Continuity Test**

Output Current	100mA(DC)
Ohmmeter Measurement Range	0.1Ω~50.0Ω
Ohmmeter Measurement Resolution	0.1Ω
Ohmmeter Measurement Accuracy	±(10% of reading+2Ω)
Ohmmeter Judgment Accuracy	±(10% of setting+2Ω)
TIMER (Test Time)	0.2s~999.9s
TIMER Accuracy	+/(100ppm+20ms)

NOTE: Since continuity test reference ground is earth ground, an additional 1Ω error should be added when RETURN terminal is connected.

**Interface**

SIGNAL IO	Yes
RS232	Yes
USB (Device)	Yes
USB (Host)	Yes (for parameter / LCD hardcopy)

**Rear Output**

CH1 – CH8	Scanner
-----------	---------

**Table 1: GPT-9500 capacitive load table**

	Test Voltage DCW	Test Condition		Maximum Capacitive Load
		HI-SET Current	RAMP Time ↗	
1	1.000kV	I $\geq$ 10.00mA	T $\geq$ 1.0s	4.7uF
2	2.000kV	I $\geq$ 7.00mA	T $\geq$ 1.0s	1.65uF
3	3.000kV	I $\geq$ 8.00mA	T $\geq$ 1.0s	1.32uF
4	4.000kV	I $\geq$ 11.00mA	T $\geq$ 1.0s	1.32uF
5	5.000kV	I $\geq$ 7.00mA	T $\geq$ 1.0s	0.66uF
6	6.000kV	I $\geq$ 8.00mA	T $\geq$ 1.0s	0.66uF

## GPT-9503/9513 Dimensions

---

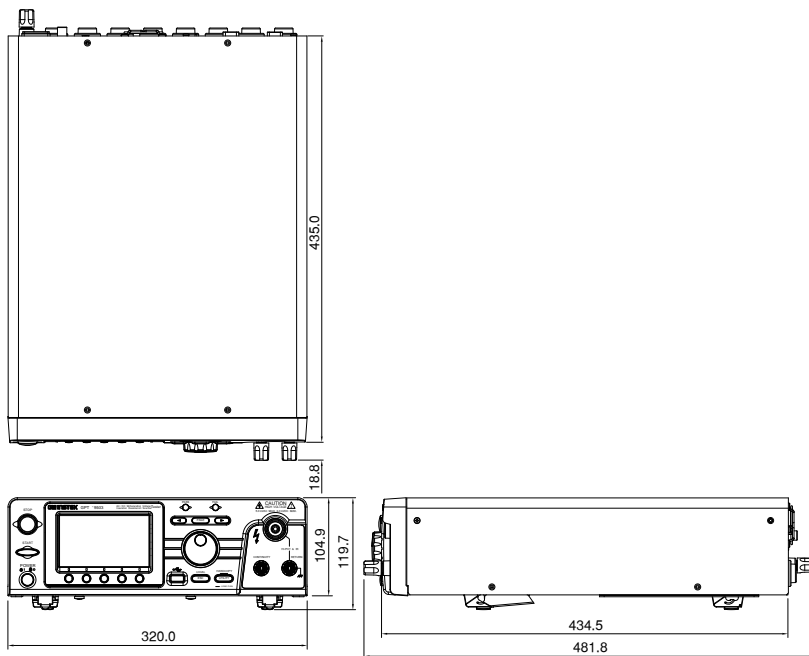

## Declaration of Conformity

We

**GOOD WILL INSTRUMENT CO., LTD.**

declare that the CE marking mentioned product satisfies all the technical relations application to the product within the scope of council:

Directive: EMC; LVD; WEEE; RoHS

The product is in conformity with the following standards or other normative documents:

<b>© EMC</b>	
EN 61326-1 :	Electrical equipment for measurement, control and laboratory use — EMC requirements
Conducted & Radiated Emission EN 55011 / EN 55032	Electrical Fast Transients EN 61000-4-4
Current Harmonics EN 61000-3-2 / EN 61000-3-12	Surge Immunity EN 61000-4-5
Voltage Fluctuations EN 61000-3-3 / EN 61000-3-11	Conducted Susceptibility EN 61000-4-6
Electrostatic Discharge EN 61000-4-2	Power Frequency Magnetic Field EN 61000-4-8
Radiated Immunity EN 61000-4-3	Voltage Dip/ Interruption EN 61000-4-11 / EN 61000-4-34
<b>© Safety</b>	
EN 61010-1 :	Safety requirements for electrical equipment for measurement, control, and laboratory use - Part 1: General requirements

### **GOODWILL INSTRUMENT CO., LTD.**

No. 7-1, Jhongsing Road, Tucheng District, New Taipei City 236, Taiwan

Tel: [+886-2-2268-0389](tel:+886-2-2268-0389)

Fax: [+886-2-2268-0639](tel:+886-2-2268-0639)

Web: <http://www.gwinstek.com>

Email: [marketing@goodwill.com.tw](mailto:marketing@goodwill.com.tw)

### **GOODWILL INSTRUMENT (SUZHOU) CO., LTD.**

No. 521, Zhujiang Road, Snd, Suzhou Jiangsu 215011, China

Tel: [+86-512-6661-7177](tel:+86-512-6661-7177)

Fax: [+86-512-6661-7277](tel:+86-512-6661-7277)

Web: <http://www.instek.com.cn>

Email: [marketing@instek.com.cn](mailto:marketing@instek.com.cn)

### **GOODWILL INSTRUMENT EURO B.V.**

De Run 5427A, 5504DG Veldhoven, The Netherlands

Tel: [+31-\(0\)40-2557790](tel:+31-(0)40-2557790)

Fax: [+31-\(0\)40-2541194](tel:+31-(0)40-2541194)

Email: [sales@gw-instek.eu](mailto:sales@gw-instek.eu)

# INDEX

- Accessories ..... 12
- Automatic test
  - add test ..... 94, 95, 109, 111
  - load ..... 92, 113, 116
  - results ..... 133
  - running a test ..... 122
  - test file name ..... 93
- Caution symbol ..... 5
- Cleaning the instrument ..... 7
- Conventions ..... 25
- Declaration of conformity ..... 269
- Dimensions ..... 268
- Disposal instructions ..... 8
- EN61010
  - measurement category ..... 7
  - pollution degree ..... 8
- Environment
  - safety instruction ..... 7
- External control ..... 190
  - Interlock key ..... 194
  - overview ..... 191
  - signal I/O operation ..... 193
  - signal I/O overview ..... 191
- FAQ ..... 258
- Front panel
  - overview ..... 22
- Front panel diagram ..... 14
- Ground
- Interlock key ..... 194
- Line voltage selection ..... 24
- List of features ..... 11
- Manual tests
  - ARC mode ..... 52, 55
  - ground mode ..... 63
  - overview ..... 40
  - pass hold ..... 98, 99, 100, 106, 107
  - ramp up time ..... 45, 59, 61
  - results ..... 86
  - running a test ..... 82
  - test frequency ..... 66
  - test function ..... 41, 43, 71
  - test limits ..... 50
  - test reference ..... 53
  - test time ..... 47
  - timing diagrams ..... 87
- Marketing
  - contact ..... 259
- Menu tree ..... 33
- Operating precautions ..... 28
- Overview ..... 10
- Package contents ..... 13
- Power on/off
- Rear panel diagram ..... 18
- Remote control ..... 195
  - Command list ..... 203
  - Command syntax ..... 200
  - function check ..... 198
  - interface configuration ..... 196
- Service operation
  - about disassembly ..... 6
  - contact ..... 259
- Specifications ..... 263
- Test errors ..... 261
- Tilt stand ..... 23
- Utility settings
  - buzzer ..... 142, 144, 145
  - Control settings ..... 174, 176, 178
  - double action ..... 174
  - interface ..... 143
  - key lock ..... 174
  - RS232 ..... 143
  - start control ..... 174
  - USB ..... 143
- Warning symbol ..... 5
- Workplace precautions ..... 27