

AC/DC High Power Electronic Load

AEL-5000 Series

USER MANUAL



ISO-9001 CERTIFIED MANUFACTURER

GW INSTEK

This manual contains proprietary information, which is protected by copyright. All rights are reserved. No part of this manual may be photocopied, reproduced or translated to another language without prior written consent of Good Will company.

The information in this manual was correct at the time of printing. However, Good Will continues to improve products and reserves the rights to change specification, equipment, and maintenance procedures at any time without notice.

Good Will Instrument Co., Ltd.

No. 7-1, Jhongsing Rd., Tucheng Dist., New Taipei City 236, Taiwan.

Table of Contents

SAFETY INSTRUCTIONS	4
GETTING STARTED.....	8
AEL-5000 Series Introduction	11
Accessories.....	16
Operating Mode Description	21
Operating Area	25
Appearance.....	32
FUNCTION DESCRIPTION	45
Function keys description	46
Store or Recall functions	65
Sequence Functions	66
Wave Function description.....	70
Test Function description	80
Entry key description	122
CONNECTION.....	124
Rear Panel	125
Master/Slave Description	128
2 operating modes for Master/Slave	130
INSTALLATION	138
Check line voltage.....	139
Grounding requirements	141
Power up	142
Connection to the load Input Terminal	143
Interface Card	144
RS232 interface option	146
GPIB interface option	146

USB interface option.....	147
LAN interface option	147
I/O connection	148
Load wire inductance.....	149
Parallel and three-phase control	153
REMOTE CONTROL.....	154
Interface Configuration	156
Communication Interface programming command list.....	158
Command Syntax	171
Command List	173
PRESET Commands	176
Limit Commands	194
STATE commands	196
System Commands	203
Measure Commands.....	206
Auto Sequence Commands	209
APPLICATION.....	212
Local sense connections	213
Remote sense connections	215
Constant Current mode and LIN mode application.....	217
Constant Resistance mode application	219
Constant Voltage mode application	221
Constant Power mode application	223
Battery discharge test application	225
Current protection component test.....	229
AC rectified load simulation.....	232
Parallel operation	233
Inrush Current	235
Power Supply OCP testing	238
Power Supply OPP testing	241

SHORT testing	244
BW Setting.....	246
Special waveform applications.....	247
APPENDIX.....	248
Replacing the Fuse.....	249
AEL-5000 Default Settings	251
AEL-5000 Dimensions.....	255
AEL-5000 series Specifications	259
Certificate Of Compliance.....	282
GPIB programming Example.....	283
AEL-5000 Series USB Instruction	287
AEL-5000 series Auto-Sequence function provide EDIT, ENTER, EXIT, TEST and STORE 5 keys operation.....	289
AEL-5000 Series LAN Instruction	294

S SAFETY INSTRUCTIONS

This chapter contains important safety instructions that you must follow during operation and storage. Read the following before any operation to insure your safety and to keep the instrument in the best possible condition.

Safety Symbols

These safety symbols may appear in this manual or on the instrument.



WARNING

Warning: Identifies conditions or practices that could result in injury or loss of life.



CAUTION

Caution: Identifies conditions or practices that could result in damage to the instrument or to other properties.



DANGER High Voltage



Attention Refer to the Manual



Earth (ground) Terminal



Frame or Chassis Terminal



Do not dispose electronic equipment as unsorted municipal waste. Please use a separate collection facility or contact the supplier from which this instrument was purchased.

Safety Guidelines

General
Guideline



CAUTION

- Do not place any heavy object on the instrument. Note: Only 2 units can be stacked vertically.
- Avoid severe impact or rough handling that leads to damaging the instrument.
- Do not discharge static electricity to the instrument.
- Use only crimped wires, not bare wires, for the terminals.
- Do not block the cooling fan opening.
- Do not disassemble the instrument unless you are qualified.
- The equipment is not for measurements performed for CAT II, III and IV.

Power Supply



WARNING

- AC Input voltage range: 100Vac~240Vac \pm 10%
- Frequency: 47-63Hz
- Power for every model

Model	Power
AEL-5002-350-18.75, AEL-5003-350-28 AEL-5004-350-37.5	150VA
AEL-5002-425-18.75 AEL-5003-425-28 AEL-5004-425-37.5	
AEL-5003-480-18.75 AEL-5004-480-28	
AEL-5006-350-56 AEL-5008-350-75 AEL-5006-425-56 AEL-5008-425-75	270VA
AEL-5012-350-112.5 AEL-5012-425-112.5	390VA

AEL-5015-350-112.5	510VA
AEL-5015-425-112.5	
AEL-5019-350-112.5	630VA
AEL-5019-425-112.5	
AEL-5023-350-112.5	750VA
AEL-5023-425-112.5	

- To avoid electrical shock connect the protective grounding conductor of the AC power cord to an earth ground.
- To avoid electric shock, the power cord protective grounding conductor must be connected to ground. No operator serviceable components inside. Do not remove covers. Refer servicing to qualified personnel.

Cleaning

- Disconnect the power cord before cleaning.
- Use a soft cloth dampened in a solution of mild detergent and water. Do not spray any liquid.
- Do not use chemicals containing harsh material such as benzene, toluene, xylene, and acetone.

Operation Environment

- Location: Indoor, no direct sunlight, dust free, almost non-conductive pollution (Note below)
- Temperature: 0°C to 40°C
- Humidity: 0 to 85% RH
- Altitude: <2000m
- Overvoltage category II

(Pollution Degree) EN 61010-1:2010 specifies the pollution degrees and their requirements as follows. The instrument falls under degree 2.

Pollution refers to "addition of foreign matter, solid, liquid, or gaseous (ionized gases), that may produce a reduction of dielectric strength or surface resistivity".

- Pollution degree 1: No pollution or only dry, non-conductive pollution occurs. The pollution has no influence.
 - Pollution degree 2: Normally only non-conductive pollution occurs. Occasionally, however, a temporary conductivity caused by condensation must be expected.
 - Pollution degree 3: Conductive pollution occurs, or dry, non-
-

conductive pollution occurs which becomes conductive due to condensation which is expected. In such conditions, equipment is normally protected against exposure to direct sunlight, precipitation, and full wind pressure, but neither temperature nor humidity is controlled.

Storage environment

- Location: Indoor
 - Temperature: -20°C to 70°C
 - Humidity: <90% RH
-

Disposal

Do not dispose this instrument as unsorted municipal waste. Please use a separate collection facility or contact the supplier from which this instrument was purchased. Please make sure discarded electrical waste is properly recycled to reduce environmental impact.

GETTING STARTED

AEL-5000 Series is suitable for the step, square and sine wave of the AC Power device test. Especially for the uninterruptible power supply UPS, Inverter, fuses, circuit breakers, power regulator AVR, Battery, AC/ DC power supply/ components ... and so on, absolutely is the best test solution in the market.



The most complete measurement function.....9

AEL-5000 Series Introduction..... 11

 Model Line Up(When Turbo is off)11

 Model Line Up(When Turbo is on).....11

 Main Features12

 Protection features14

Accessories..... 16

 AEL-5002-xxx-18.75/ AEL-5003-xxx-28/
 AEL-5004-xxx-37.516

 AEL-5006-xxx-56/ AEL-5008-xxx-78/
 AEL-5012-xxx-112.5/ AEL-5015-xxx-112.5/

AEL-5019-xxx-112.5/ AEL-5023-xxx/112.5.....17

Operating Mode Description21

 AC load mode.....21

 DC load mode23

Operating Area25

Appearance.....32

 Front Panel.....32

 LCD Display.....34

AEL-5000 LOAD
Operating mode

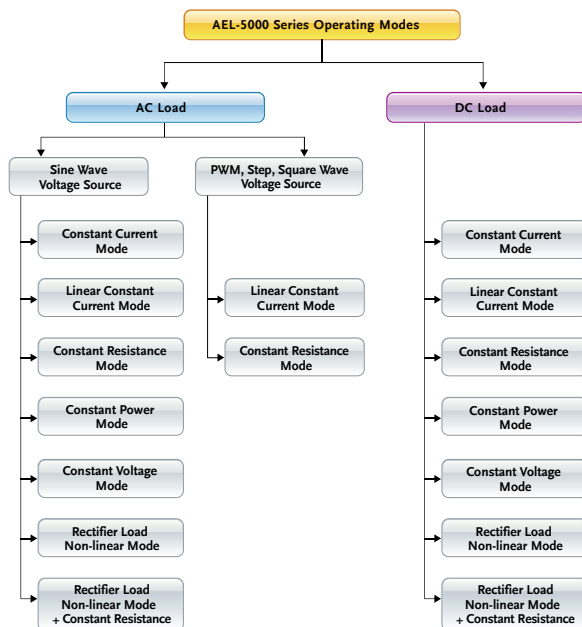

The most complete measurement function

AEL-5000 Series AC/ DC electronic load has built-in 16-bit precision measurement circuit, providing accurate measurement values, measuring items include voltage rms (V_{rms}), current rms (A_{rms}), watts (Watt), volt ampere (VA), crest factor (CF), power factor (PF), voltage total harmonic distortion (VTHD), voltage harmonics (VH), current total harmonic distortion (ITHD), current Harmonics (IH), peak current (I_{peak}), maximum ampere (A_{max}), minimum ampere

(Amin), maximum voltage (Vmax), and minimum voltage (Vmin).

In addition to these measurement functions, it also provides time measurement, such as UPS back up time, fuses and circuit breakers' trip or blow time and Off-line UPS transfer time.

 Note*1

ms= milli-siemens = 1/kΩ

 Note*2

The operating temperature range is 0 ~ 40°C,
accuracy of this specification is 25°C ± 5°C

AEL-5000 test mode

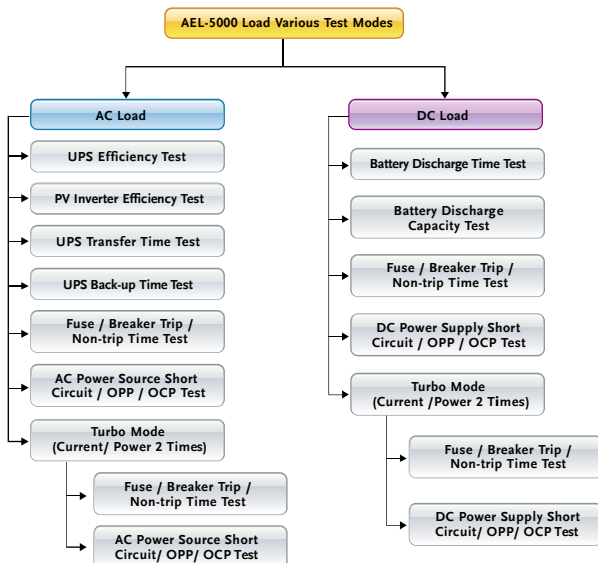

AEL-5000 Series Introduction

Model Line Up(When Turbo is off)

Model	Voltage (Volt)	Current	Power
AEL-5002-350-18.75	50~350Vrms/500Vdc	18.75 Arms/ 56.25Apeak	1875 W
AEL-5003-350-28	50~350Vrms/500Vdc	28 Arms / 84Apeak	2800W
AEL-5004-350-37.5	50~350Vrms/500Vdc	37.5 Arms / 112.5Apeak	3750 W
AEL-5006-350-56	50~350Vrms/500Vdc	56.0Arms/168Aprak	5600W
AEL-5008-350-75	50~350Vrms/500Vdc	75.0Arms/225Aprak	7500W
AEL-5012-350-112.5	50~350Vrms/500Vdc	112.5.0Arms/337.5Aprak	11250W
AEL-5015-350-112.5	50~350Vrms/500Vdc	112.5.0Arms/337.5Aprak	15000W
AEL-5019-350-112.5	50~350Vrms/500Vdc	112.5.0Arms/337.5Aprak	18750W
AEL-5023-350-112.5	50~350Vrms/500Vdc	112.5.0Arms/337.5Aprak	22500W
AEL-5002-425-18.75	50~425Vrms/600Vdc	18.75 Arms/ 56.25Apeak	1875 W
AEL-5003-425-28	50~425Vrms/600Vdc	28 Arms / 84Apeak	2800W
AEL-5004-425-37.5	50~425Vrms/600Vdc	37.5 Arms / 112.5Apeak	3750 W
AEL-5006-425-56	50~425Vrms/600Vdc	56.0Arms/168Aprak	5600W
AEL-5008-425-75	50~425Vrms/600Vdc	75.0Arms/225Aprak	7500W
AEL-5012-425-112.5	50~425Vrms/600Vdc	112.5.0Arms/337.5Aprak	11250W
AEL-5015-425-112.5	50~425Vrms/600Vdc	112.5.0Arms/337.5Aprak	15000W
AEL-5019-425-112.5	50~425Vrms/600Vdc	112.5.0Arms/337.5Aprak	18750W
AEL-5023-425-112.5	50~425Vrms/600Vdc	112.5.0Arms/337.5Aprak	22500W
AEL-5003-480-18.75	50~480Vrms/700Vdc	18.75 Arms / 56.25Apeak	2800W
AEL-5004-480-28	50~480Vrms/700Vdc	28 Arms / 84Apeak	3750 W

Model Line Up(When Turbo is on)

Model	Voltage (Volt)	Current	Power
AEL-5002-350-18.75	50~350Vrms/500Vdc	37.5Arms/56.25Apeak	3750W
AEL-5003-350-28	50~350Vrms/500Vdc	56Arms/84Apeak	5600W
AEL-5004-350-37.5	50~350Vrms/500Vdc	75.0Arms/112.5Apeak	7500W
AEL-5006-350-56	50~350Vrms/500Vdc	112.0Arms/168Aprak	11200W
AEL-5008-350-75	50~350Vrms/500Vdc	150.0Arms/225Aprak	15000W
AEL-5012-350-112.5	50~350Vrms/500Vdc	225.0Arms/337.5Aprak	22500W
AEL-5015-350-112.5	50~350Vrms/500Vdc	225.0Arms/337.5Aprak	30000W

AEL-5019-350-112.5	50~350Vrms/500Vdc	225.0Arms/337.5Aprak	37500W
AEL-5023-350-112.5	50~350Vrms/500Vdc	225.0Arms/337.5Aprak	45000W
AEL-5002-425-18.75	50~425Vrms/600Vdc	37.5Arms/56.25Apeak	3750W
AEL-5003-425-28	50~425Vrms/600Vdc	56Arms/84Apeak	5600W
AEL-5004-425-37.5	50~425Vrms/600Vdc	75.0Arms/112.5Apeak	7500W
AEL-5006-425-56	50~425Vrms/600Vdc	112.0Arms/168Aprak	11200W
AEL-5008-425-75	50~425Vrms/600Vdc	150.0Arms/225Aprak	15000W
AEL-5012-425-112.5	50~425Vrms/600Vdc	225.0Arms/337.5Aprak	22500W
AEL-5015-425-112.5	50~425Vrms/600Vdc	225.0Arms/337.5Aprak	30000W
AEL-5019-425-112.5	50~425Vrms/600Vdc	225.0Arms/337.5Aprak	37500W
AEL-5023-425-112.5	50~425Vrms/600Vdc	225.0Arms/337.5Aprak	45000W
AEL-5003-480-18.75	50~480Vrms/700Vdc	37.5Arms/56.25Apeak	5600W
AEL-5004-480-28	50~480Vrms/700Vdc	56Arms/84Apeak	7500W

Main Features

- Performance
- Four meters can be displayed V/A/W Meter, display the Voltage (Vrms, Vpeak, Vmax., Vmin), Current (Irms, I Peak, Imax. Imin.) Watt, Voltampere (VA), Frequency, Crest Factor, Power Factor, Total Harmonic Distortion of Voltage (VTHD), Voltage Harmonic (VH), Total Harmonic Distortion of Current (ITHD), Current Harmonic (IH) Remote Control via a choice of Computer interfaces.
 - Support on-load boot; at first set Load ON to support on-load boot, inverter or uninterruptible power supply is turned on directly with the set load current, used to verify whether the starter is stable when the Inverter is connected.
 - Supports the loading and unloading angle control; the loading and unloading angle control, the full range of 0-359 degrees can be set to verify whether the Inverter output voltage transient response is stable when the actual electrical plugging and unplugging, and

whether Overshoot/Undershoot is within the allowable range.

- Support positive half-cycle or negative half-cycle loading; used to verify whether the inverter output voltage remains stable when the actual appliance has only positive half-cycle or negative half-cycle load current.
- Supports SCR/TRIAC current phase modulation waveforms, 90 degree Trailing edge and Leading Edge.
- Supports the Inrush Current of the power supply at startup and the Surge Current test when the load is suddenly plugged in (Hot Plug-in).

Features

- AC / DC load with CC, Linear CC, CR, CV, CP and Rectifier Load mode
 - Frequency Range : DC, 40~440Hz
 - Crest factor adjustable range : 1.4~5.0
 - Power factor (PF) adjustable range: 0~1 lead or (~1~0)lag
 - Built-in test modes include UPS Efficiency, PV Inverter Efficiency, UPS Back-up time, Battery Discharge time, UPS transfer time, Fuse/Breaker Trip / Non-Trip, short circuit simulation, OCP, OPP, etc.
 - Turbo mode, which can withstand up to twice the current (225A) and power (45KW) electronic load in a short time, the most suitable for Fuse / Breaker and AC power short circuit, OCP, OPP test.
 - Eight units parallel up to 540KW and three-phase Δ or Y load connection can be Synchronized control by one master unit.
 - Can be controlled by external voltage for CC, Linear CC, CR, CP, CV mode (Option).
 - Measure the fuse and circuit breaker trip or
-

	<p>blow time.</p> <ul style="list-style-type: none"> • Measure the UPS OFF- line transfer time (Transfer time) • Perform short circuit simulation(can set the short circuit time), OCP, OPP test • Over voltage warning, over current, over power, over temperature protection. • 150 set Store/Recall memory.
Interface	<ul style="list-style-type: none"> • Optional interface: GPIB, RS232, USB, LAN.

Protection features

The protection features of the AEL-5000 series electronic load modules are as follows:

Overvoltage protection The Electronic Load input will turn OFF if the overvoltage circuit is tripped. The message OVP will be displayed on the LCD. When the OVP fault has been removed the load can be set to sink power again. While the unit will attempt to protect itself given an OVP state it is strongly advised to guard against any potential OVP fault state by using external protection and the correctly rated electronic load.

The Overvoltage protection circuit is set at a predetermined voltage and cannot be adjusted. The OVP level is 105% of the AEL-5000 Series nominal voltage rating.



Caution

Do not apply a DC voltage that is higher than AEL-5000 Series Load rating. If this advice is ignored it is likely that damage will be caused to the electronic load module. This damage will not be covered by the warranty.

Over current protection (OCP) The OCP protection will engage if the current being taken by the load reaches 105% of the load module's maximum current. The message OCP will be displayed on the front panel and the unit

	will switch to its LOAD OFF state. Once the source of the over current has been removed the load can be switched on again.
Over power protection (OPP)	The AEL-5000 Series Electronic Load monitors the power dissipation level. The input to the load is automatically switched to LOAD OFF if the power dissipation is greater than 105% of the rated power input. If an over power condition occurs the display will show OPP
Over temperature protection	The load internal temperature at the heat sink is monitored. If the temperature reaches approximately 100°C the OTP message will be displayed and the unit will automatically switch to the LOAD OFF state. If an OTP error occurs please check the ambient temperature is between 0 to 40°C. Also ensure that the front and rear air vents of the mainframe are not obstructed. The air flow is taken from the front of the mainframe and exhausted from the rear. Therefore a suitable gap needs to be left at the rear of the mainframe. A minimum of 15cm is recommended. After a suitable cooling period the load can be switched.

Accessories

AEL-5002-xxx-18.75 / AEL-5003-xxx-28 / AEL-5004-xxx-37.5

Standard Accessories	Description	PCs
AEL-5000 series operation manual	It can be downloaded from GW instek website.	
PVL 1-4; RING TERMINALS	Please refer to Fig. 4 on page 20	2
RNYBS8-4; RING TRML	Please refer to Fig. 5 on page 20	2
PTV1-12; PIN TRML	Please refer to Fig. 1 on page 19	6
HD-DSUB	15pin MALE to MALE 150cm	1

Terminals diagram

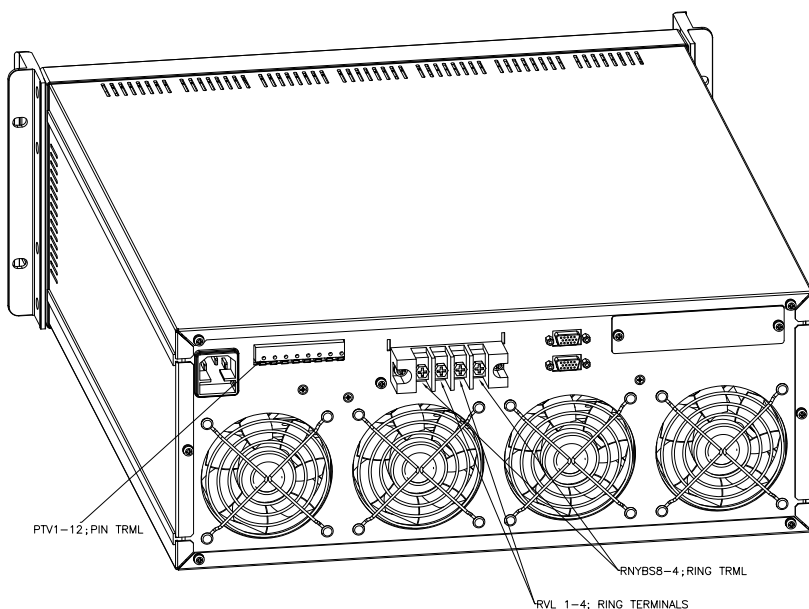

AEL-5006-xxx-56/ AEL-5008-xxx-78/ AEL-5012-xxx-112.5/ AEL-5015-xxx-112.5/ AEL-5019-xxx-112.5/ AEL-5023-xxx/112.5

Standard Accessories	Description	PCs
AEL-5000 series operation manual	It can be downloaded from GW instek website.	1
PTV1-12; PIN TRML	Please refer to Fig. 1 on page 19	6
SLS10B RED; PLUG CONN 20A RED	Please refer to Fig. 2 on page 19 The terminal is used for Vsense	1
SLS10B BLK; PLUG CONN 20A BLK	Please refer to Fig. 2 on page 19 The terminal is used for Vsense	1
RNB S22-6; RING TRML,#4	Please refer to Fig. 3 on page 20	2
HD-DSUB	15pin MALE to MALE 150cm	1
Terminals diagram		

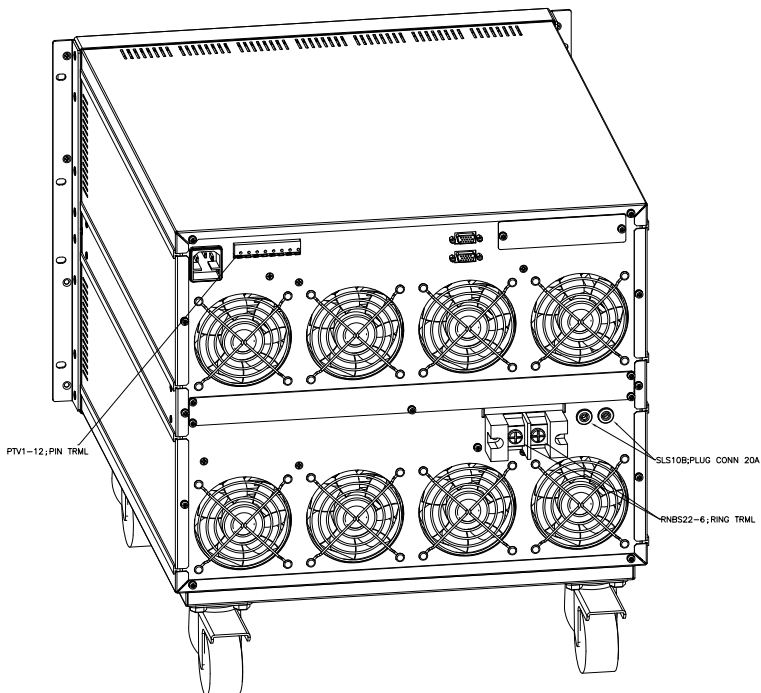

Optional Accessories	Description	PCs
GPIB+RS232 interface	PEL-030	1
RS232 interface	PEL-023	1
GPIB interface	PEL-022	1
USB interface + USB driver (The driver can be downloaded from GW instek website)	PEL-025	1
LAN interface + LAN driver (The driver can be downloaded from GW instek website)	PEL-024	1
GPIB cable	GTL-250 GPIB Cable,0.6m	1
GPIB cable	GTL-248 GPIB Cable,2m	1
USB cable	GTL-246 USB Cable,1.2m	1

AEL-5006, AEL-5008, AEL-5012 and AEL-5015 handle	PEL-028	1
AEL-5002, AEL-5003 and AEL-5004 handle	PEL-029	1

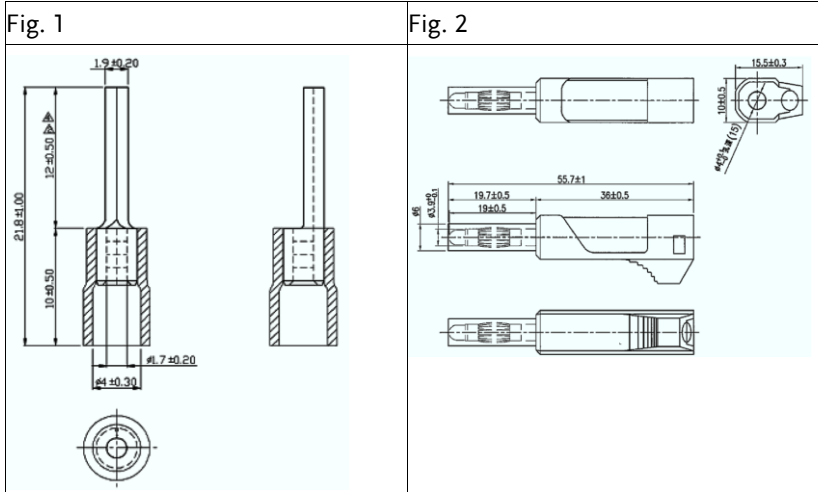

Fig. 3

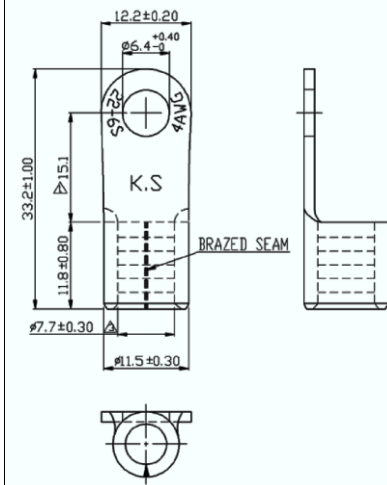

Fig. 4

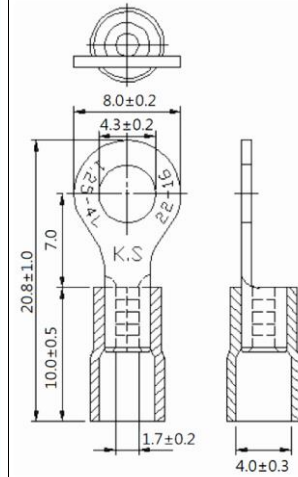
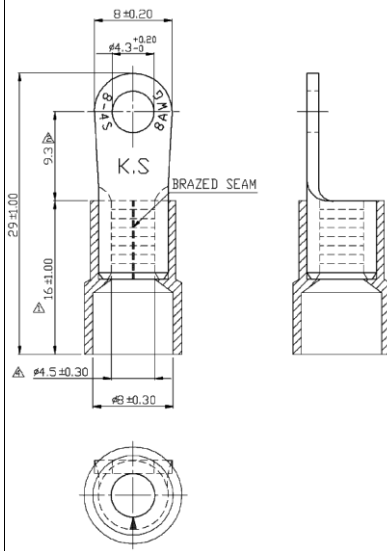

Fig. 5



Operating Mode Description

AC load mode

CC Mode With the operating mode of Constant Current, the AEL-5000 Series electronic load will sink a current in accordance with the programmed value regardless of the input voltage

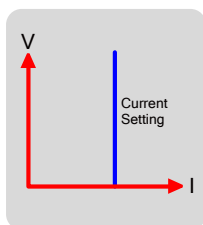

Linear C.C. Mode During Linear C.C. mode, the load current input into AEL-5000 Series High Power Electronic Load depends on the current setting regardless of the input voltage, e.g., the current setting remains unchanged. Please refer to fig below. The load input current signal will follow input voltage signal that is useful for step wave-form and square wave-form device.

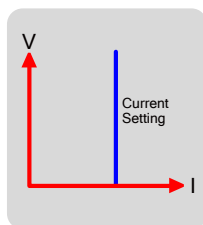

CR Mode At Constant Resistance mode, the AEL-5000 Series Electronic Load will sink a current linearly proportional to the load input voltage in accordance with the programmed resistance

setting

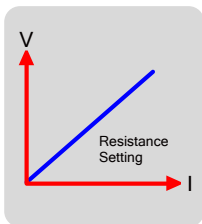

CP Mode

At Constant Power mode, the AEL-5000 Series Electronic Load will attempt to sink load power (load voltage * load current) in accordance with the programmed power.

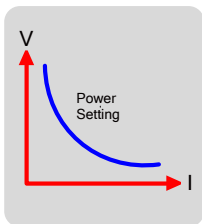

CV Mode

At Constant Voltage mode, the AEL-5000 Series Electronic Load will attempt to sink enough current until the load input voltage reaches the programmed value.

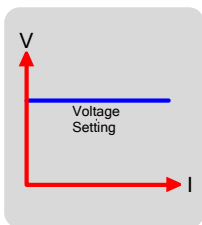

DC load mode

CC Mode

With the operating mode of Constant Current, the AEL-5000 Series electronic load will sink a current in accordance with the programmed value regardless of the input voltage

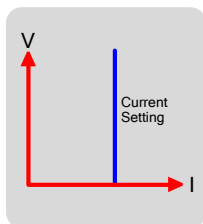

CR Mode

At Constant Resistance mode, the AEL-5000 Series Electronic Load will sink a current linearly proportional to the load input voltage in accordance with the programmed resistance setting

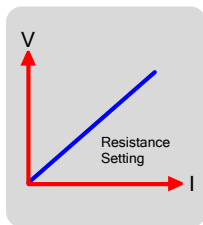

CP Mode

At Constant Power mode, the AEL-5000 Series Electronic Load will attempt to sink load power (load voltage * load current) in accordance with the programmed power.

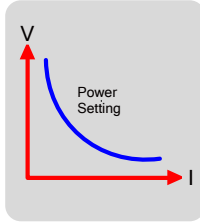
**CV Mode**

At Constant Voltage mode, the AEL-5000 Series Electronic Load will attempt to sink enough current until the load input voltage reaches the programmed value.

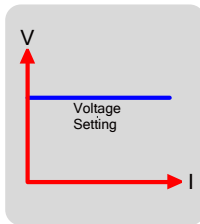

Operating Area

AEL-5000 Series AC/DC electronic load can be used to work with GPIB, RS232, USB or LAN interface and panel manual operation can be made available.

The electronic load operating environment temperature is 0 °C ~ 40 °C, full power operation for a period of time may produce OTP.

AEL-5002-350-18.75

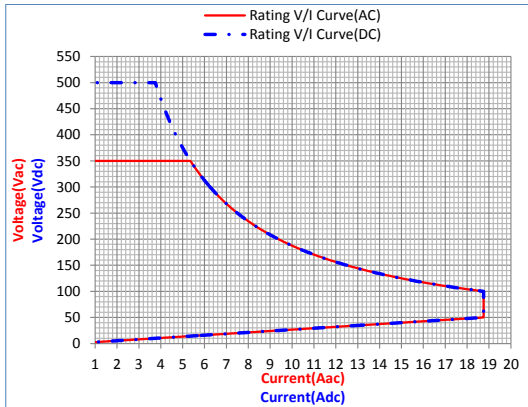

AEL-5003-350-28

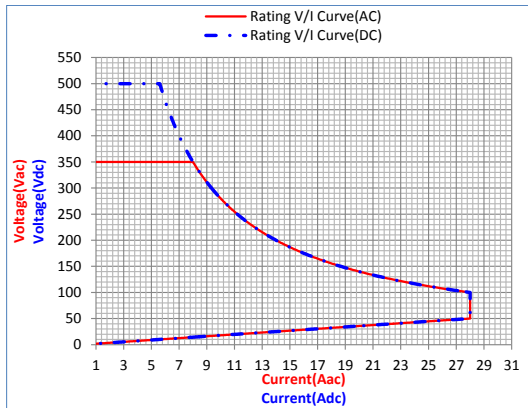

AEL-5004-350-37.5

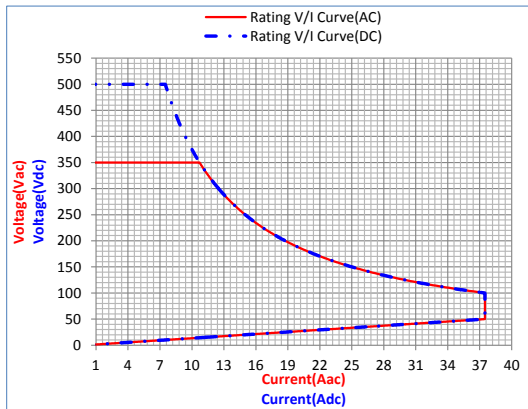

AEL-5006-350-56

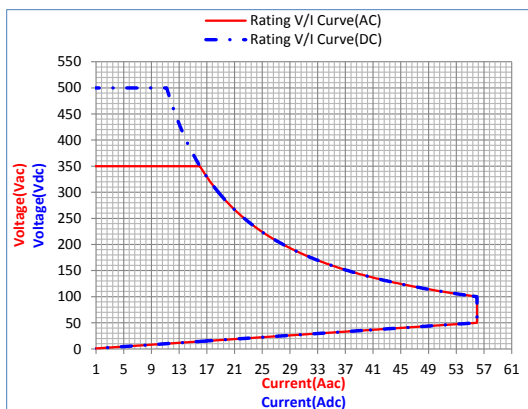

AEL-5008-350-75

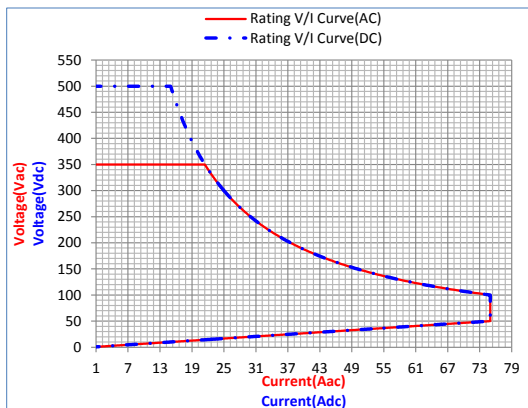

AEL-5012-350-112.5

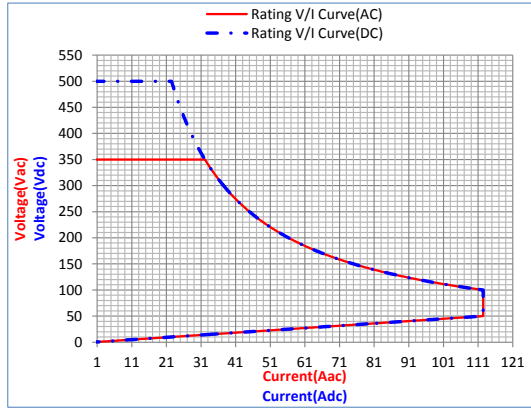

AEL-5015-350-112.5

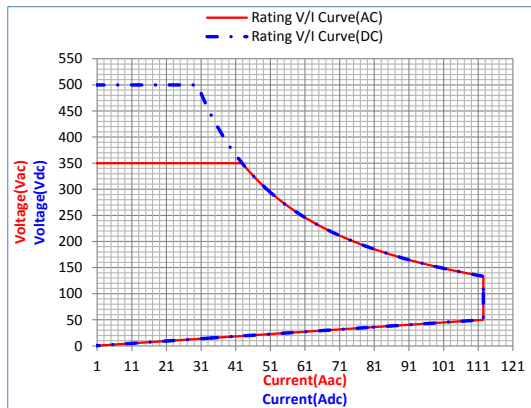

AEL-5019-350-112.5

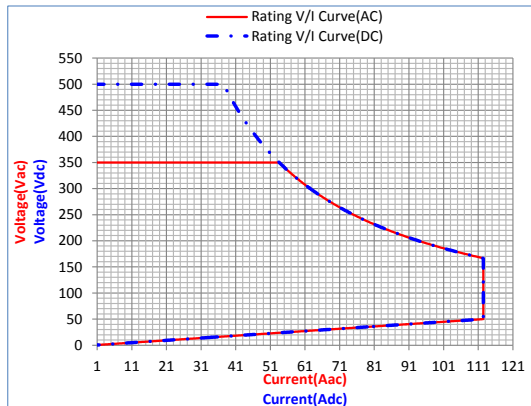

AEL-5023-350-112.5

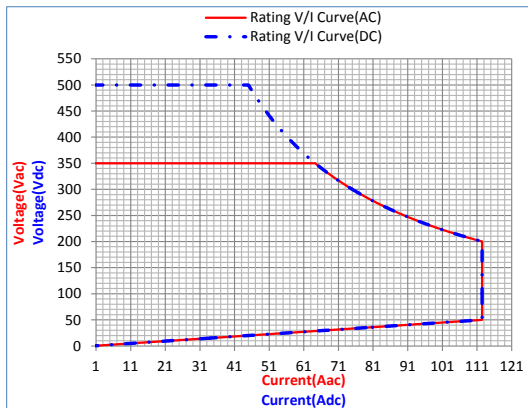

AEL-5002-425-18.75

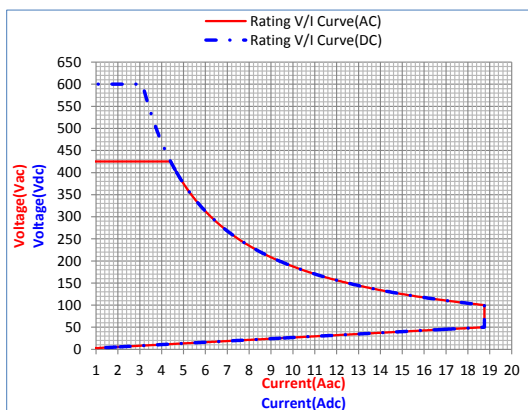

AEL-5003-425-28

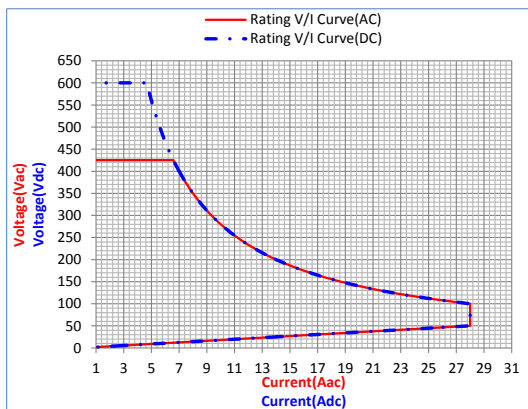

AEL-5004-425-37.5

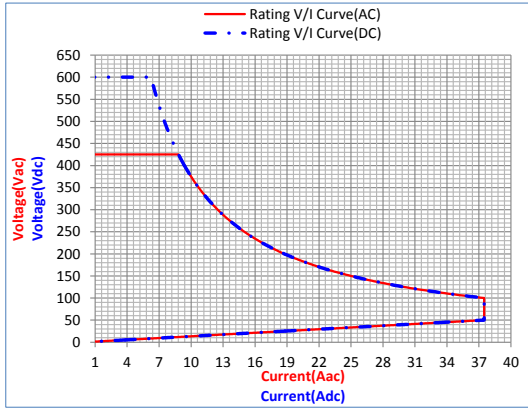

AEL-5006-425-56

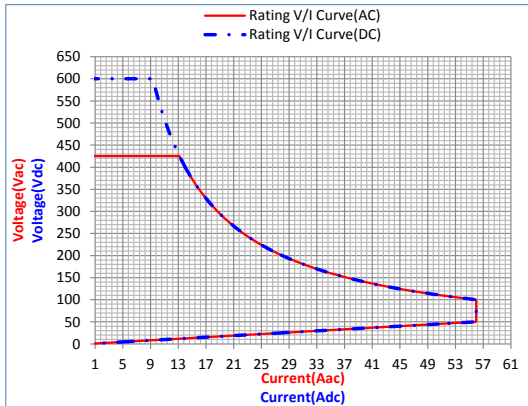

AEL-5008-425-75

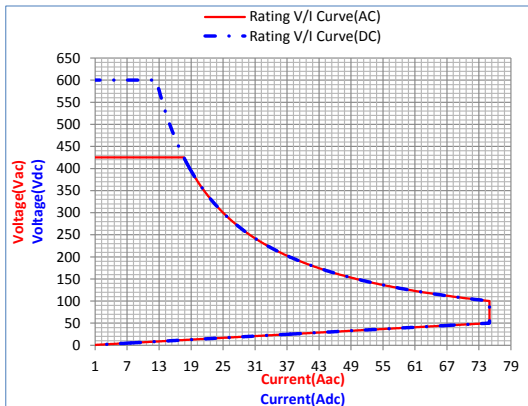

AEL-5012-425-112.5

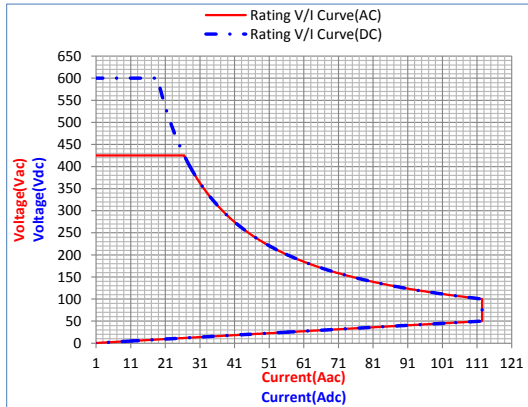

AEL-5015-425-112.5

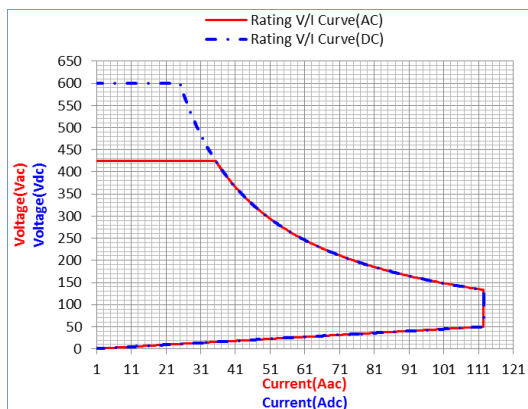

AEL-5019-425-112.5

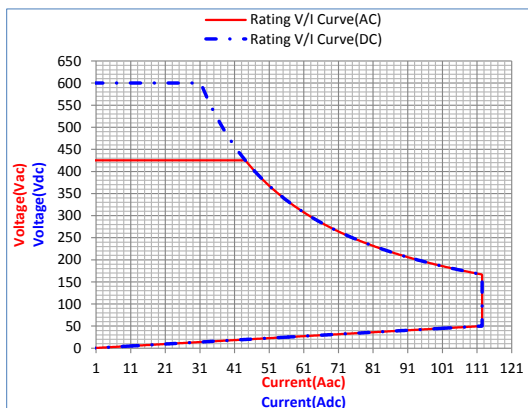

AEL-5023-425-112.5

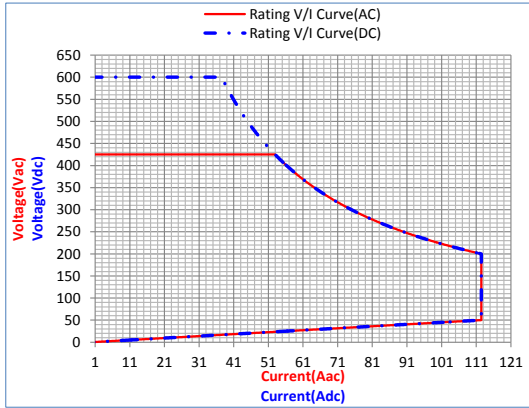

AEL-5003-480-18.75

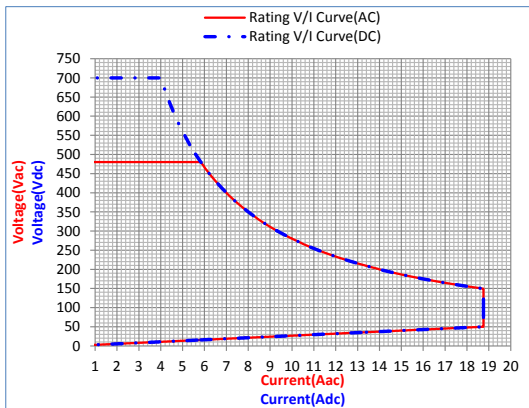

AEL-5004-480-28

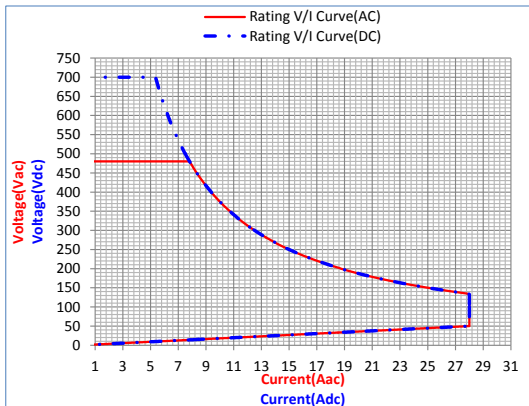

Appearance

Front Panel

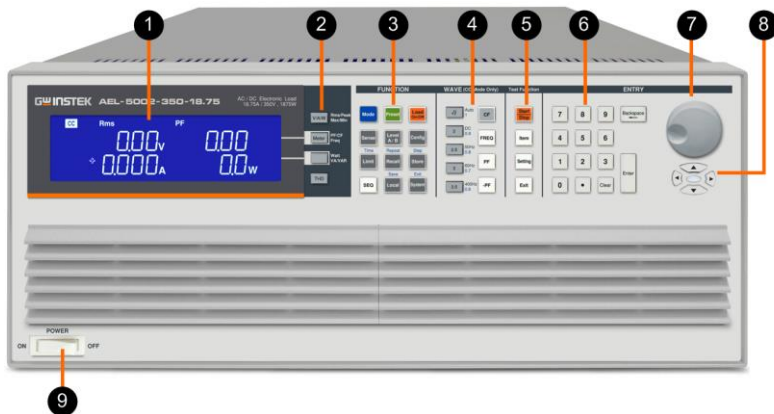

- | | | |
|---|----------------------------|---|
| 1 | LCD Multi-function display | Four meters can display the voltage value at the same time Voltage(V_{rms} , V_{peak} , V_{max} , V_{min}), Current (I_{rms} , I_{peak} , I_{max} , I_{min}), Watt, Voltampere (VA), Frequency, Crest Factor, Power Factor, Total Harmonic Distortion of Voltage(VTHD), Voltage Harmonic (VH), Total Harmonic Distortion of Current (ITHD), Current Harmonic (IH) |
| 2 | Meter Switch button | V/A/W keys can set the display Rms/Peak/Max/Min, Meter key can select PF/CF/FREQ, switchable display WATT/VA/VAR keys, THD keys choose to display THD. |
| 3 | Operate function keys | Mode, Preset ON/OFF, Load ON/OFF, Sense ON/OFF, Level A/B, Config, Limit, Recall, Store, SET, Local, System operate keys. |
| 4 | Waveform library keys | These keys can be quickly set CF /2/2.5/3/3.5, PF0.6/0.7/0.8/0.9/1.0, FREQ |

Auto/50Hz/60Hz/400Hz

- 5 Test function keys These keys can select Short/OPP/OCP/Non-L/NL-CR/Fuse/Batt(Battery Discharge)Trans(UPS transfer time) test functions.
- 6 Number keypad
- 7 Knob setting
- 8 Cursor and button setting
- 9 Power switch

LCD Display

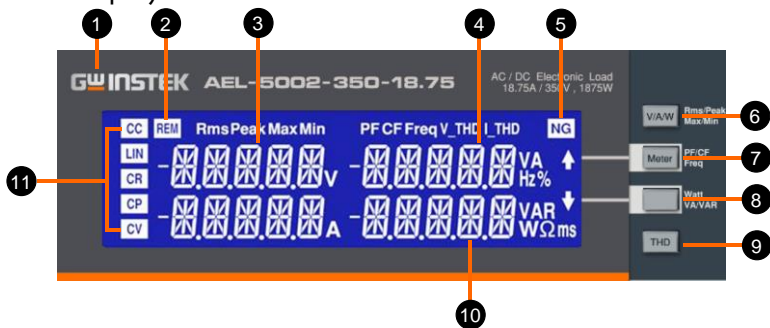

- | | | |
|---|------------------------------|---|
| 1 | Model number and sink ranges | Refers to model number, voltage, current and power specification of AEL-5000 Series High Power AC/DC Electronic Load. |
| 2 | REM LCD Indicator | When AEL-5000 Series AC/DC Electronic Load is connected with computer program for control and operation, REM LED Indicator will come on. In such a case, panel manual operation will become null and void. When REM LED indicator comes off, panel manual operation will resume. |
| 3 | Left 5 digit LCD display | The 5 digit LCD display is a multi-function display. The function of the display changes depending whether the user is in NORMAL mode or in a SHORT, OPP, Non-L, NL+CR, FUSE, BATT , TRANS, INRUSH, SURGE test modes |
| | Normal mode | The left 5 digit display displays the voltage present at the load's input terminals. The value displayed will include the automatic voltage compensation if the sense terminals are also connected to the device under test (DUT).

If V-sense is set to "ON" and the sense terminals are connected to the DUT the load will check and compensate for all voltage |

		drops.
Test mode		<p>If the Item buttons are pressed the left display will show a text Message that correlates with the selected test function.</p> <ul style="list-style-type: none"> • SHORT test selected: left display will show "Short". • OPP test selected: left display will show "OPP". • OCP test selected: left display will show "OCP". • Non-L test selected: left display will show "Non-L". • NL+CR test selected: left display will show "NL+CR". • FUSE test selected: left display will show "FUSE". • BATT test selected: left display will show "BATT". • TRANS test selected: left display will show "TRANS". • INRUSH test selected: left display will show "INRUSH". • SURGE test selected: left display will show "SURGE". <p>During the test the left display will show the load Input voltage.</p>
4	Right upper 5 digit LCD display	The right upper 5 digit displays also changes function depending if the user is in normal mode or has entered a setting menu.
	Normal mode	In normal mode the middle LCD display functions as a 5 digit ammeter. The 5 digit DAM shows the load current flowing into the DC load when the Load is ON.
	Setting mode	If CONFIG, LIMIT, buttons are pressed the

middle LCD show a text message according to the setting function it is in. Each subsequent press of the button moves the display to the next available function. The sequence of each setting menu is detailed below

- CONFIG:
Sequence is "EXTIN OFF" → SYNC OFF → "LD ON" → "LDOFF" → "BW" → "AVG" → "CPRSP" → "CYCLE" → "SNUB".
- LIMIT:
Sequence is "V_Hi" → "V_Lo" → "I_Hi" → "I_Lo" → "W_Hi" → "W_Lo" → "VA_Hi" → "VA_Lo" → "OPL" → "OCL" → "NG".

5 NG LCD indicator The user can adjust upper and lower limits for voltage, current and power within the CONFIG menu and turn the NG Indicator ON. If a voltmeter, ammeter or wattmeter measurement is outside these set limits then the NG indicator will illuminate.

6 V/A/W key There are four operating modes. These can be selected in turn by pressing the "V/A/W" key on the AEL-5000 Series AC/DC Electronic Load. The sequence is:

- Rms
- Peak
- Max
- Min

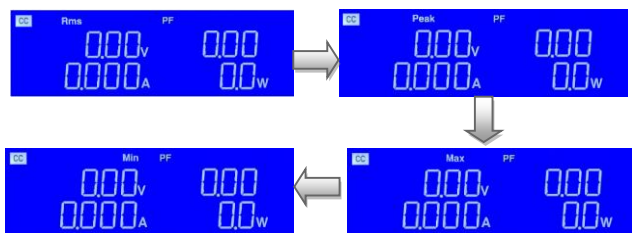

7 Meter key There are three operating modes. These can be selected in turn by pressing the "Meter" key on

the AEL-5000 Series AC/DC Electronic Load.
The sequence is:

- PF
- CF
- Freq

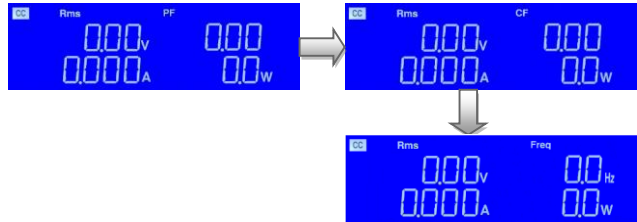

8 WATT/VA/ VAR Key

There are three operating modes. These can be selected in turn by pressing the “WATT/VA/VAR” key on the AEL-5000 series AC/DC Electronic Load. The sequence is:

- W
- VA
- VAR

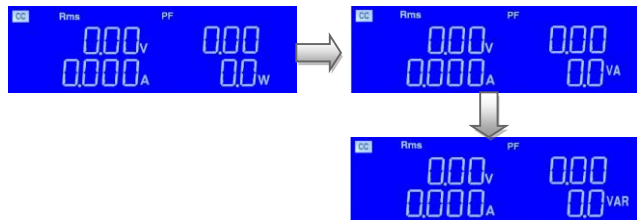

9 THD Key

There are four operating modes. These can be selected in turn by pressing the “THD” key on the AEL-5000 Series AC/DC Electronic Load. The sequence is:

- V_THD
- I_THD
- V_H
- I_H

- PF

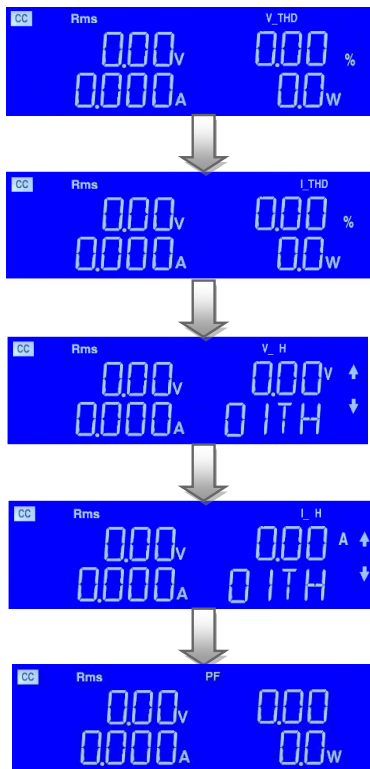

- In V_H operating modes, these can be selected in turn by pressing the "PF/ CF/ FREQ" key and WATT/ VA/ VAR Key to adjust, the setting range is 01TH ~ 50TH.



- In I_H operating modes, these can be selected in turn by pressing the “PF/CF/FREQ” key and WATT/VA/VAR Key to adjust, the setting range is 01TH~ 50TH.



10 Right lower 5 digit LCD display

The right 5 digit displays also changes function depending if the unit is in normal mode or one of the setting menus has been activated.

Normal mode

In normal mode the right 5 digit displays shows the power consumption in Watts (W).

Setting mode

The right display together with the rotary adjustment knob is used to set values.

The value changes according to the setting function that is active. The middle LCD provides a text message to tell the user which part of the setting menu is active.

PRESET mode

The value of the setting entered on the right display changes depending on the operating MODE that has been selected

- If CC mode is selected the right display provides setting in amps "A".
 - If LIN mode is selected the right display provides setting in amps "A".
 - If CR mode is selected the right display provides setting in ohms " Ω ".
 - If CP mode is selected the right display provides setting in watts "W".
 - If CV mode is selected the right display provides setting in volts "V".
-

LIMIT

Each press of the LIMIT button changes the middle LCD text. The sequence and the corresponding setting value shown on the bottom display is as follows:

- V_Hi (left limit voltage) displays the set value in volts "V"
 - V_Lo (right limit voltage) displays the set value in volts "V"
 - I_Hi (left limit current) displays the set value in amps "A"
 - I_Lo (right limit current) displays the set value in amps "A"
 - W_Hi (left limit power) displays the set value in watts "W"
 - W_Lo (right limit power) displays the set value in watts "W"
 - VA_Hi (left limit power) displays the set value in VA "VA"
 - VA_Lo (right limit power) displays the set
-

value in VA "VA"

- OPL (right limit power) displays the set value in watts "W"
 - OCL (right limit power) displays the set value in amps "A"
 - NG displays whether the NG flag is set to "ON" or "OFF".
-

CONFIG

Each press of the CONFIG button changes the right upper LCD Text.

The sequence and the corresponding setting value shown on the bottom displays are as follows:

- EXTIN can be set to "OFF" or "ON"
- SYNC can be set to "OFF" or "ON"
- LD ON can be set to 0 to 359
- LDOFF can be set to 0 to 359
- BW can be set to "AUTO" or 1 to 15.
- AVG can be set to 1, 2, 4, 8, 16.
- CPRSP can be set to 0~7.
- CYCLE can be set to 1~16.
- SNUB can be set to "AUTO" or "ON" or "OFF".

SHORT Test

This allows the parameters of the short test to be set up.

Each press of the Item button and Setting button moves the setting function. The sequence of the short test along with the setting value is as follows:

- Short Press Start (pressing the red START/STOP button starts the test)
TURBO shows the ON or OFF.
 - TIME shows the duration of the SHORT
-

test. "CONTI", on the bottom display indicates continuous. Time can be adjusted in "ms".

- V-Hi (voltage high threshold) displays the set value in volts "V".
- V-Lo (voltage low threshold) displays the set value in volts "V".

When the test is started the right display will show RUN. When the test has finished the right display will show END.

OPP Test

This allows the parameters of the over power protection test to be set up. Each press of the Item button and Setting button moves the set function. The sequence of the OPP test along with the setting value is as follows:

- OPP Press Start (pressing the red START/STOP button starts the test) TURBO shows the ON or OFF.
- PSTAR (power start point) right display provides setting in watts "W".
- PSTEP (power steps) right display provides setting in watts "W".
- PSTOP (power stop point) right display provides setting in watts "W".
- VTH (voltage threshold) right display provides setting in volts "V".

When the test is started the right display will show the power value being taken by the load. If the Device Under Test is able to supply the load according to the values set then the right display will show PASS and the right display will show the maximum power taken during the OPP test. If, during the test, OTP is displayed the over temperature protection has been engaged. Similarly if OPP is shown on the

display the over power protection has been activated.

OCP Test

This allows the parameters of the over current protection test to be set up. Each press of the Item button and Setting button moves the setting function. The sequence of the OCP test along with the setting value is as follows:

- OCP Press Start (pressing the red START/STOP button starts the test) TURBO shows the ON or OFF.
- ISTAR (current start point) right display provides setting in amps "A"
- ISTEP (current steps) right display provides setting in amps "A"
- ISTOP (current stop point) right display provides setting in amps "A"
- VTH (voltage threshold) right display provides setting in volts "V"

When the test is started the right display will show the current value being taken by the load. If the Device under Test is able to supply the load according to the values set then the middle display will show PASS and the right display will show the maximum current taken during the OCP test. If, during the test, OTP is displayed the over temperature protection has been engaged. Similarly if OPP is shown on the display the over power protection has been activated.

11 Mode and Indicators

On the AEL-5000 Series AC/DC Electronic Load, there are 5 working modes which can be selected by MODE key with the sequence of Constant Current, Linear Constant Current, Constant Resistance, Constant Power and Constant Voltage. Then switching can be made in such a sequence. However, LED indicator of

CC, LIN, CR, CP and CV will display the working mode selected.

FUNCTION DESCRIPTION

Function keys description	46
Store or Recall functions	65
Sequence Functions	65
Wave Function description.....	70
Test Function description	80
Entry key description	120

Function keys description



Mode and CC,
LIN, CR, CP,
CV Indicator



There are five operating modes. These can be selected in turn by pressing the "MODE" key on the AEL-5000 series AC/DC Electronic Load module. The sequence is:

- (CC) Constant Current
- (LIN) Linear Constant Current
- (CR) Constant Resistance
- (CP) Constant Power
- (CV) Constant Voltage

The appropriate LCD will illuminate according to the operating mode is selected.

Load key and
LED
indicators



The input to the AEL-5000 Series AC/DC Electronic Load can be switched ON/OFF by using the "LOAD" button. Indication of the ON/OFF state is provided by illumination of the button.

LOAD button lit = LOAD ON (load sinks according to the preset values)

LOAD button unlit = LOAD OFF (the load does not sink current)

Turning the LOAD OFF does not affect the preset values. When the LOAD ON state is enabled the unit will revert to sinking according to the preset values.

LD ON and LDOFF are set the open and close loading angle control, the full range of 0-359 degree.

Level A/B key
and LED
indicators

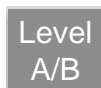

Pressing Level Key will be B, press again will be A, further pressing will be B again and so on. B means Level B (LED ON), e.g., to move out Level A, then move in level B. A means Level A (LED OFF), e.g., to move out Level B, then move in Level A.

Under the condition of setting Memory A or B, this key is mainly for setting the values of groups A/B for rapid switching load current or resistance.

Sense key and
LED
indicators

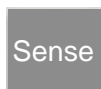

The voltmeter and internal trigger circuit of AEL-5000 series AC/DC electronic load can be controlled by this Key thus determining whether or not the input to the voltmeter is made from the AC input terminal (OFF) or Vsense terminal (ON). Upon Vsense ON, LED indicator will be ON and the 5 digit voltmeter can display the voltage read from Vsense. Upon Vsense OFF, the 5 digit voltmeter can display the voltage read from AC input terminal.

Preset key and
LED
indicators



If the PRESET key is pressed the button will become lit indicating that the PRESET mode has been accessed. The lowest 5 digit display will change from showing the power consumption in watts to displaying the value to be preset. The value that can be programmed changes

according to the operating mode that has been selected.

- Constant Current (CC) mode:
The A and B levels of load current can be preset at right lower 5 digit LCD. The "A" LED will be lit indicating the setting value is amps.
- Linear Constant Current (LIN) mode:
The A and B levels of load current can be preset at right lower 5 digit LCD. The "A" LED will be lit indicating the setting value is amps.
- Constant Resistance (CR) mode:
The A and B levels of load resistance can be preset on the right lower 5 digit LCD. The "Ω" LED will be lit indicating the setting value is ohms.
- Constant Voltage (CV) mode:
The A and B levels of load voltage can be preset on the right lower 5 digit LCD. The "V" LED will be lit indicating the setting value is volts.
- Constant Power (CP) mode:
The A and B levels of load power can be preset on the right lower 5 digit LCD. The "W" LED will be lit indicating the setting value is watts.

Limit key



Limit

The LIMIT button allows the user to set left and right thresholds for voltage, current or power. These threshold settings are used in conjunction with the NG function to flag when the load is operating outside the desired limit.

Each press of the LIMIT key enables a different value to be entered. On first

press of the LIMIT key the button will illuminate and V-Hi will be displayed on the right LCD. The setting is made with the rotary knob and can be read from the right LCD during setting. The setting sequence is shown below:

- V_Hi (DVM upper limit)
- V_Lo (DVM lower limit)
- I_Hi (DAM upper limit)
- I_Lo (DAM lower limit)
- W_Hi (DWM upper limit)
- W_Lo (DWM lower limit)
- VA Hi
- VA Lo
- OPL
- OCL
- NG OFF/ON (No Good Flag)
- LIMIT setting function OFF

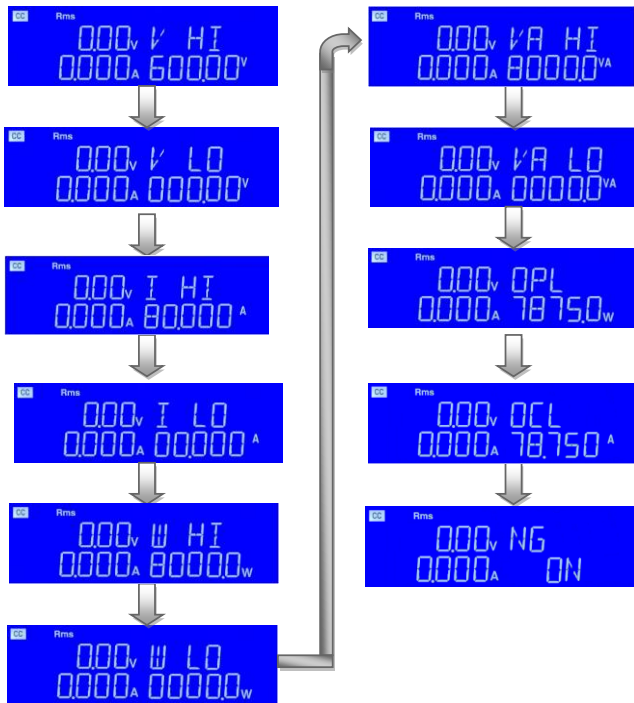

- Setting upper limit voltage VH , the right upper 5 digit monitor display the "V-Hi" and right lower monitor display upper limit of the voltmeter with the unit as "V" ,The V-Hi set range from 0.00 V to 600.00V step 0.01V by rotating the Setting knob.

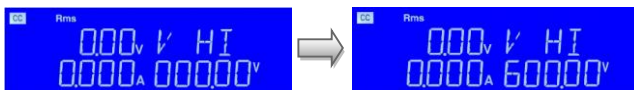



- Setting lower limit voltage VL, the right upper 5 digit monitor display "V-Lo" and right lower monitor display lower limit of the voltmeter with the unit as "V", The V-Lo set range from 0.00 V to 600.00V step 0.01V by rotating the Setting knob.

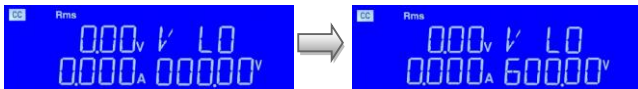

- Setting upper limit current IH, the right upper 5 digit monitor display "I-Hi" and right lower monitor display upper limit of the voltmeter with the unit as "A", The I-Hi set range from 0.000 A to 80.000A step 0.001A by rotating the Setting knob.

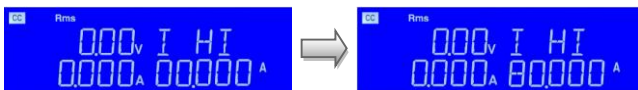

- Setting lower limit current IL, the right upper 5 digit monitor display "I-Lo" and right lower monitor display lower limit of the voltmeter with the unit as "A", The I-Lo set range from 0.000 A to 80.000A step 0.001A by rotating the Setting knob.

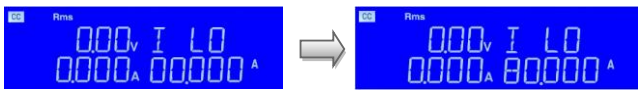

- Setting upper limit power WH, the right upper 5 digit monitor display "W-Hi" and right lower monitor display upper limit of the voltmeter with the unit as "W", The W-Hi set range from 0 W to 8000.0W step 1W by rotating the Setting knob.



- Setting lower limit power WL, the right upper 5 digit monitor display “W-Lo” and right lower monitor display lower limit of the voltmeter with the unit as “W”, The W-Lo set range from 0.0 W to 8000.0W step 0.1W by rotating the Setting knob.



- Setting upper limit power VAH, the right upper 5 digit monitor display “VA-Hi” and right lower monitor display upper limit of the voltmeter with the unit as “VA”, The VA-Hi set range from 0 VA to 8000.0VA step 0.1VA by rotating the Setting knob.

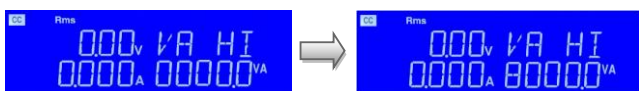

- Setting lower limit power VAL, the right upper 5 digit monitor display “VA-Lo” and right lower monitor display lower limit of the voltmeter with the unit as “W”, The VA-Lo set range from 0.0 VA to 8000.0VA step 0.1VA by rotating the Setting knob.

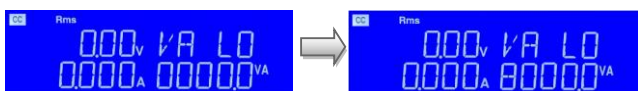



- Setting OPL, the right upper 5 digit monitor display "OPL" and right lower monitor display upper limit of the voltmeter with the unit as "W", The OPL set range from 0.1W to 7875W step 0.1W by rotating the Setting knob.

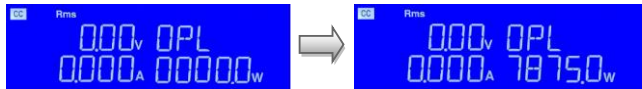

- Setting OCL, the right upper 5 digit monitor display "OCL" and right lower monitor display upper limit of the voltmeter with the unit as "A", The OCL set range from 0.001 A to 78.75A step 0.001A by rotating the Setting knob.

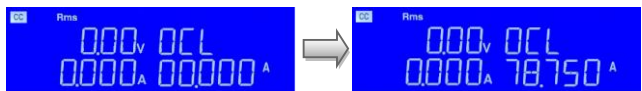

- Setting NG ON/OFF, When exceed VH, VL, IH, IL, WH, WL, VAH, VAL One of these whether NG on LCD display.

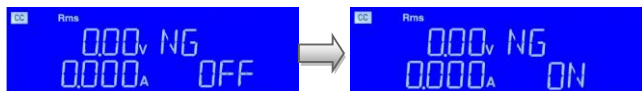

- CC mode, press limits key to set the V-Hi and V-Lo voltage upper and lower limits of the GO / NG.

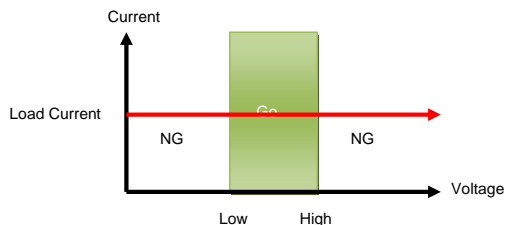

Limit

- CR mode, press limits key to set the V-Hi and V-Lo voltage upper and lower limits of the GO / NG.

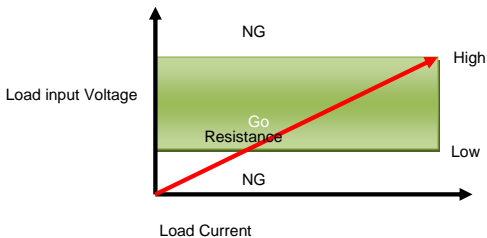

Limit

- CV mode, press limits key to set the I-Hi and I-Lo Current upper and lower limits of the GO / NG.

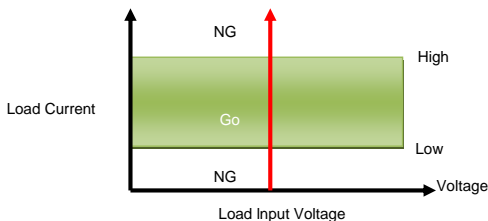

Limit

- CP mode, press limits key to set the W-Hi and W-Lo power upper and lower limits of the GO / NG.

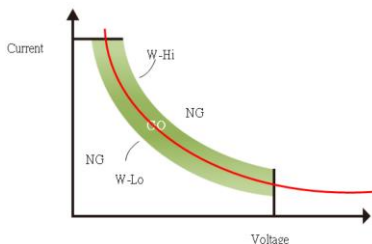

Config key



Config

The CONFIG key allows the sense function to engage automatically or switched ON. The CONFIG key also enables the LOAD to automatically turn ON/OFF When a voltage level is reached.

Each press of the CONFIG key moves the menu on one step. On first press of the CONFIG key the button will illuminate and EXTIN will be displayed on the Right upper LCD. The value is adjusted with the rotary knob and can be read from the right LCD during setting. The setting sequence is shown below:

- EXTIN OFF
- SYNC OFF
- LD ON
- LD OFF
- BW
- AVG
- CPRSP
- CYCLE
- SNUB
- Exit CONFIG

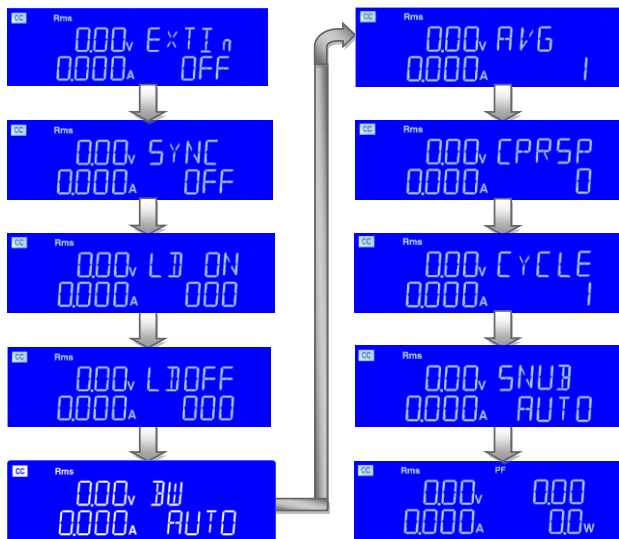

- The right upper 5 digit monitor display the EXTIN and right lower monitor display OFF or ON for external input disable or enable, Default is OFF

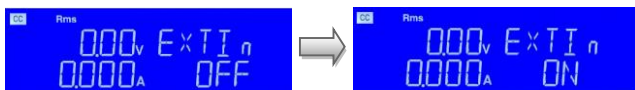

There is an analog signal setting input connector on the back panel of the AEL-5000 series chassis to control the magnitude of the load current, that is, the load current is proportional to the magnitude of the analog signal. In the fixed current mode, if you want to directly control the load by the voltage, you can use this analog signal input. The input voltage range is 0Vdc ~ 10Vdc.

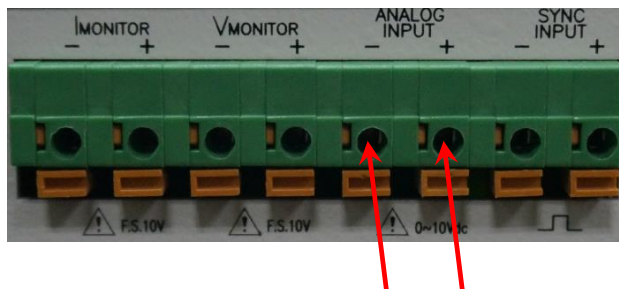

Setting specifications F.S/ 10Vdc, resolution 0.1V. In constant current mode, 0V to 10V analog input signal can set load current from 0A to full scale. Take AEL-5004-350-37.5 as an example, 10V analog input signal can generate 37.5A load current.

In constant power mode, 0V to 10V analog input signal can set load power from 0W to full scale. Take AEL-5004-350-37.5 as an example, 10V analog input signal can generate 3750W load power.



CAUTION

The above operation must be LOAD ON.

The measured analog input is 5Vdc (CH3), and the electronic load is set to Constant current mode.

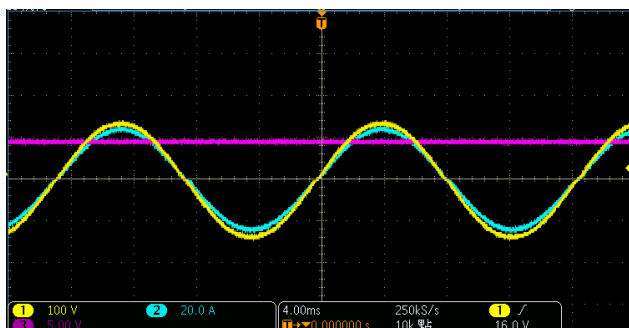

CH1=voltage (100V); CH2 current (18.75A)

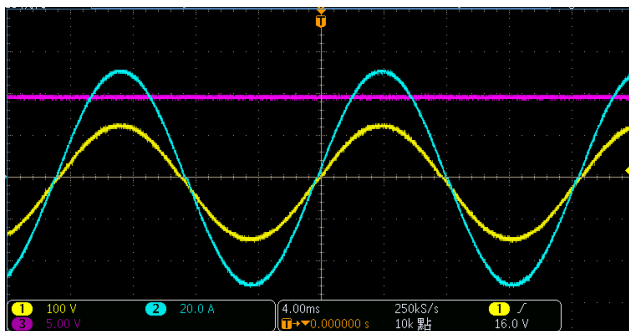

1. Measured Analog input 10Vdc (CH3), the electronic load is set to constant current mode.
CH1=voltage (100V); CH2 current (37.5A)
2. Measured analog input, input voltage 10Vdc downward adjustment (CH3), the electronic load is set to constant current mode.

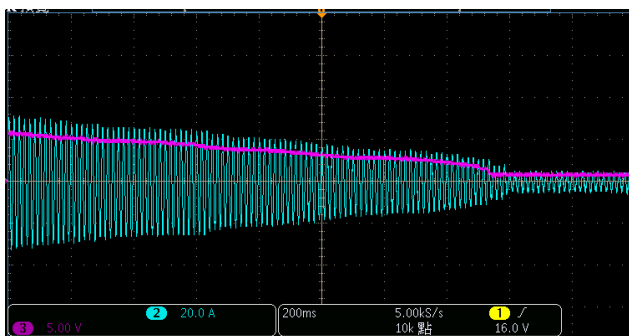

- The right upper 5 digit monitor display the SYNC and right lower monitor display OFF or ON for synchronous from external source disable or enable of rear panel I/O input terminal. Default is OFF. SYNC operating range: TTL 5V Signal, TTL Hi level > 2.0V, TTL Low level < 0.8V

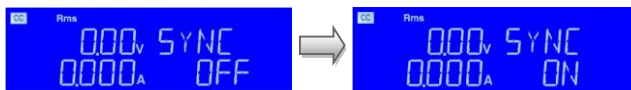



- The right upper 5 digit monitor display the LDON and right lower monitor display load on angle setting with the unit as "degree". The range is 0 to 359 degree.

LD ON/LD OFF is to set the angle of overloading and unloading.

You can specify any angle of the sine wave to start loading and unloading.

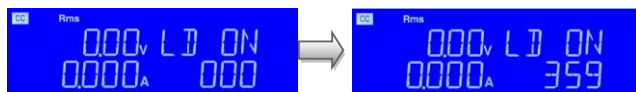

- The right upper 5 digit monitor display the LDOFF and right lower monitor display load off angle setting with the unit as "degree". The range is 0 to 359 degree. Default is 0.

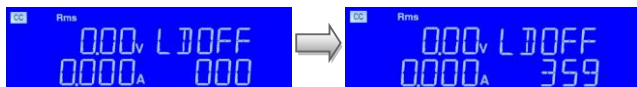

- The right upper 5 digit monitor display the BW and right lower monitor display the setting value for different bandwidth. The range is 00 ~ 15 and AUTO, Default is AUTO.

When the UUT reacts slowly, there will be oscillation. Please adjust the BW appropriately to meet the UUT reaction time. In BW AUTO, set the load current to be 14 when the load current is less than 1/3 of the specification, and automatically set to 13 when it's greater than 1/3 of the specification.

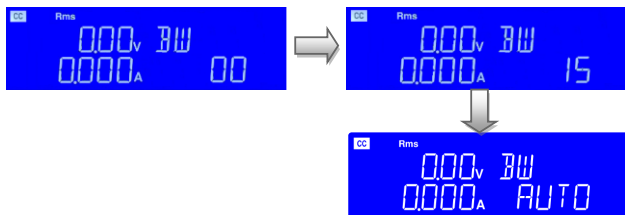

- The right upper 5 digit monitor display the AVG and right lower monitor display 1 for average value. The range is 1, 2, 4, 8, 16. Default is 1.

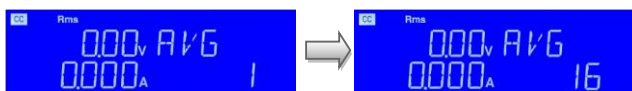

- The right upper 5 digit monitor display the CPRSP and right lower monitor Display 0 for CPRSP value. The range is 0~7, Default is 0.

CPRSP is set to constant power response.

0 ~ 3 response time for linear current constant power mode, that means linear current waveform with constant power mode, the current waveform will follow the voltage waveform, and 0 is the fastest, and 3 is the slowest.

4 ~ 7 response time for standard current with constant power, which means the constant power mode can support CF waveform, and 4 is fastest, 7 is slowest.



- The right upper 5 digit monitor display the CYCLE and right lower monitor display 1 for CYCLE value. The range is 1~16, Default is 1.

CYCLE means the updated cycle of the meter. For example: Setting is 8 means that it will be updated after reading eight datas.

The update cycle can be increased when the meter jumps severely.

The difference with AVG is that it does not do multiple data averaging calculations.

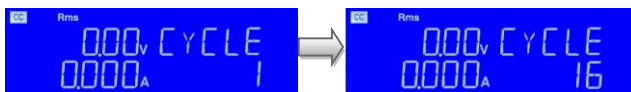

- The right upper 5 digit monitor display the SNUB and right lower monitor display "AUTO", use the knob and the key to switch AUTO or ON or OFF. SNUB is a Snubber circuit, which is used for frequency compensation. When it is set to AUTO, if the LOAD setting load current or power is greater than 1/3 of the specification, the Snubber circuit will be start up automatically.

It can also be set to ON or OFF.

When this circuit is started up, an extra small current will be generated. Please refer to the specification table "Current of input impedance".

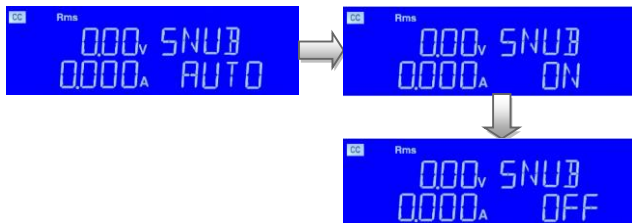

System key

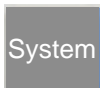

Press SYSTEM to set the argument, GPIB address, RS232 BAUD- RATE, WAKE UP and buzzer Alarm power ON/OFF and Master/Slave control.



Setting system parameters

Set GPIB address, RS232 BAUD RATE, WAKE UP, Buzzer ON/OFF and Master/Slave control.

Set GPIB address



First press SYSTEM key, the Left 5 digit monitor display the "GPIB", the right upper 5 digit monitor display "Addr", the right lower 5 digit monitor display setting GPIB address of the representative, Press UP, DOWN buttons to adjust the GPIB address 1~30, Key and then press ENTER, AEL-5000 series GPIB Address value is saved, Press system key four times to leave the GPIB address configuration State.

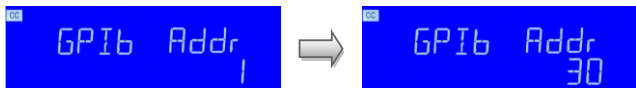

Set RS232
BAUD RATE

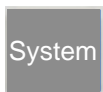

SYSTEM key first by the second, the Left 5 digit monitor display the "RS232", the right upper 5 digit monitor display the "baud" and right lower monitor display setting BAUD-RATE value, Press UP, DOWN buttons to adjust the value of BAUD RATE, Key and then press ENTER, AEL-5000 Series is saved setting BAUD RATE, press system key three times to leave the BAUD-RATE setting state.

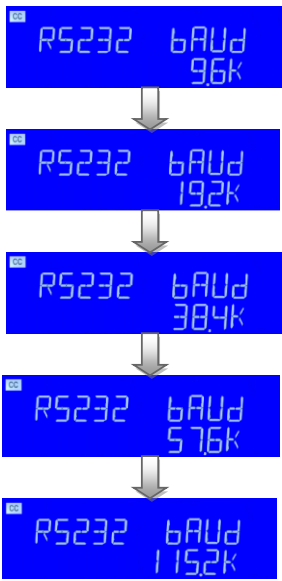

WAKE-UP
function

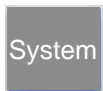

This function is designed for auto setting the load status and load level in turning on The AEL-5000 Series every time. SYSTEM key first by the three.

The Left 5 digit monitor display the "WAKE", the right upper 5 digit monitor display the "UP", and right lower monitor

display setting value, Press UP, DOWN buttons to adjust the 0~150.

Press ENTER key to be stored, press system key two times to leave the WAKE-UP setting state, If set to "0" means do not call.



Buzzer ON/
OFF

This is audio indicated the test result for automatically sequency (AUTO SEQUENCE)test function. When the test result is PASS that beeper will make a sound.When the test result is FAIL that beeper will make 2 sounds.

Setting method:

Press SYSTEM key 4 times, it will display following screen and then press UP or DOWN key to select bEEP ON or bEEP OFF.

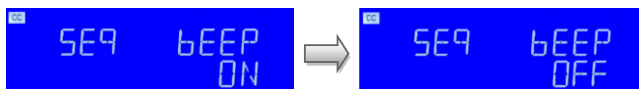

 Note

Setting system parameters, if the input is required to use the KEYPAD ENTER button to confirm, otherwise AEL-5000 Series will not save the changes the settings.

Pass: Automatic test mode, no NG state, is the PASS.

Fail: Automatic test mode, any test if the NG then is the FAIL.

Local key



Press LOCAL key to exit REMOTE mode

Store or Recall functions

The function keys on the front panel of AEL-5000 Series mainframe are designed for high testing throughput purpose. There are 150 operation states or testing steps can be store in the EEPROM memory of AEL-5000 Series electronic load respectively, each state can store or recall the load status and level for Electronic load simultaneously.

Store key

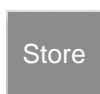

Process

- Set the load status and load level.
- Press the STORE key to enter the storage state.
- Press UP, DOWN key or KEYPAD to adjust, press the ENTER OK to Save the STATE.

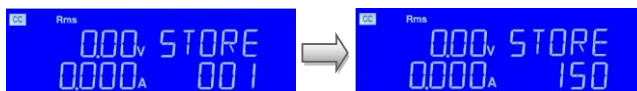

Recall key

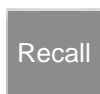

Process

- Press RECALL to enter the call state.
- Press UP, DOWN key or KEYPAD to adjust.
- Finally press the ENTER key to confirm, in the electronic load front panel, set the value that would call out the information in accordance with resetting.



Sequence Functions

SEQ key



Press SEQ key to enter SEQ setting mode, LED indicator ON, the setting sequence is as follows:

Use UP and DOWN keys to set EDIT F1 or TEST F1 mode, if you want to leave SYSTEM (Exit)

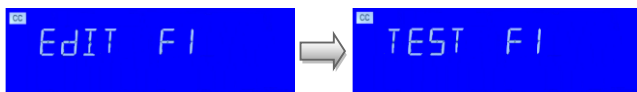

Edit mode



- Press the SEQ key to enter the AUTO SEQUENCE Mode, Press UP, DOWN key to select EDIT, the LCD display shows "EDIT" on left 5 Digit LCD display, the right 5 digit LCD display "FX", "FX" means to select the state F1-F9, Press keypad key 1 ~ 9 choose F1 ~ F9.

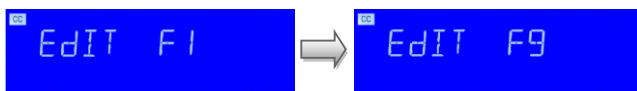

- Press ENTER key, the LCD display shows "FX-XX" on left 5 digit LCD display, middle 5 digit LCD display "STATE", right 5 digit LCD display setting 1~150, "FX" means to select the state F1-F9. "XX" means the test STEP01-16, setting state value, press UP and down Key or keypad to adjust setting.

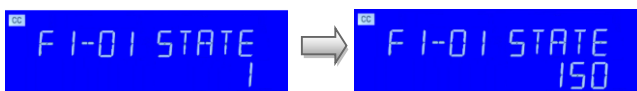

Test time setting

- Press ENTER to set TIME value, press UP, DOWN keys or KEYPAD to adjust settings, range from 100 ms~9999ms. Press SAVE key to finish editing the action is set to REPEAT, If you do not save the settings, press the EXIT key to leave edit mode.



- Setting REPEAT (REPEAT TEST), Press UP and DOWN key or Keypad to adjust setting 0~9999, Press SAVE REPEAT Value, or press EXIT key exit EDIT MODE.

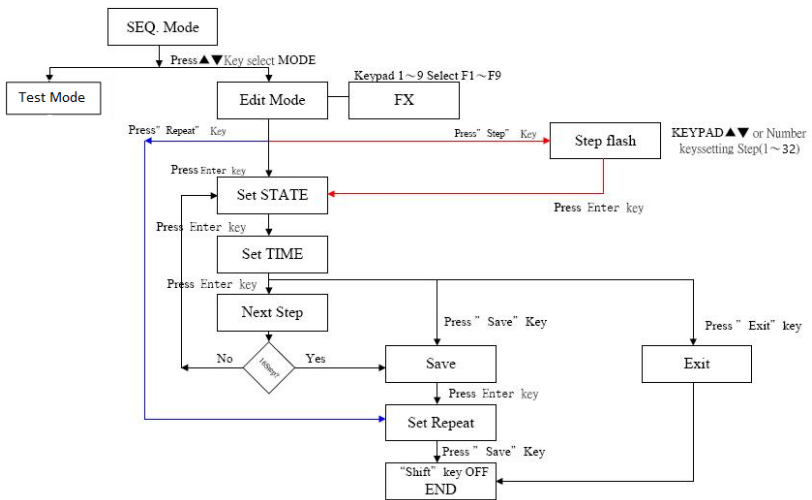
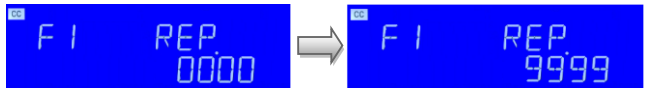

Store (Edit) mode operation flow chart

Test mode



- Press the SEQ key simultaneously to enter the AUTO SEQUENCE Mode, and press UP or DOWN key to TEST function, To use the key pad to setting 1~9 for F1 to F9 and press ENTER key to execute the automatic test mode.

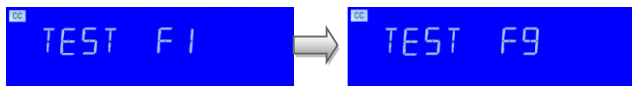

To execute the automatically test mode the LCD display will display "SXX", S means step and XX means step no(step 1~16) to indicated which step no under the testing, if the test Result is NG; the LCD display will show "NG" (flashing) and suspension of the test until user press ENTER key to continue test or press EXIT key to leave the test mode, the automatically test mode will be finish when test to the end of step or press EXIT key to leave the test mode.

If all the test steps are OK, the test result is PASS, LCD display will show "PASS"; if any one step is NG, the test result will be FAIL; LCD display will show "FAIL", If the beeper ON/OFF is set to ON, when the test result is PASS the beeper will beep one sound, if the test result is FAIL, the beeper will beep 2 sounds.

When the test is finished, user can press the ENTER key again to test or press EXIT key to leave the test mode.

Example 1

- The test step setting to 16 step, press the TEST key, the execute result is PASS, the LCD display shown PASS.

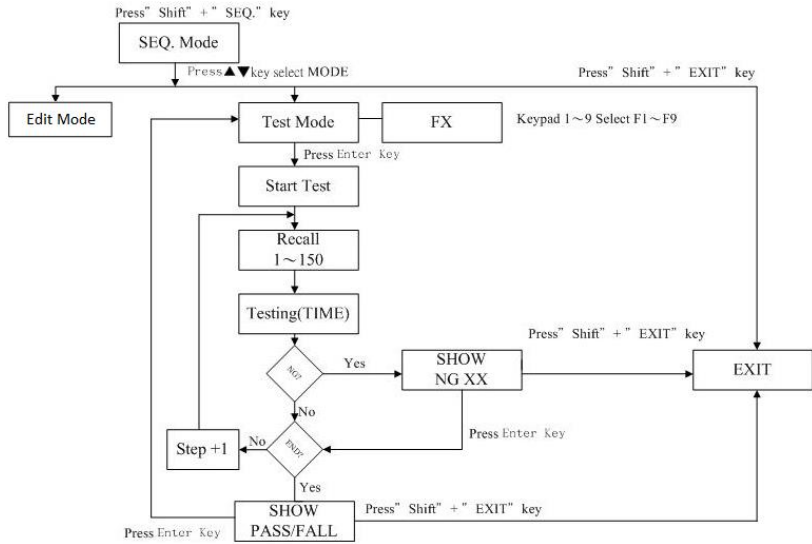
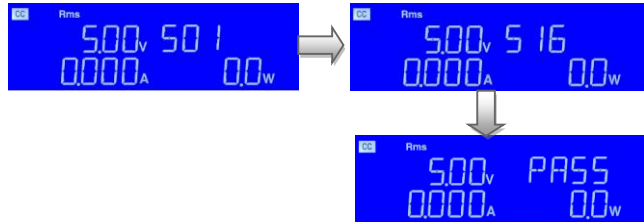

Test mode operation flow chart

Wave Function description



CF key and
 $\sqrt{2}$, 2, 2.5, 3,
 3.5 keys



CF key only functions upon C.C. and C.P. mode and all LED off upon Linear C.C., C.R. and C.V. mode. $\sqrt{2}$, 2, 2.5, 3, 3.5 keys are used to quick change the current C.F. (Crest Factor) of C.C. mode. However, adjust the CF by number key or Up, Down or rotary switch to setting the C.F. values.

The CF key can be set to the range of 1.0, 1.1, 1.2, 1.3, 1.4 to 5.0, and the CF 1.0 to 1.3 is the SCR/TRIAC current phase modulation waveforms and the half-wave load simulation. The waveforms of the first cycle and the last cycle may differ depending on the angle setting of LD ON and LDOFF. The setting sequence is as follows:

- 1.4 ~5.0
- (1.3)TRAIL: Trailing edge
- (1.2)LEAD: Leading edge
- (1.1)LDNEG: negative half-cycle loading
- (1.0) LDPOS: positive half-cycle loading

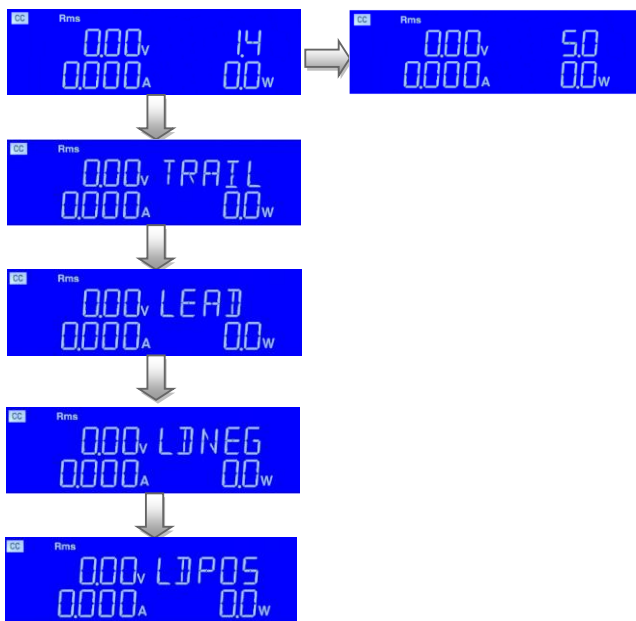

 Note

In CP mode and CPRSP 0~3, Linear Current (LIN) method is used for loading, while for CPRSP 4~7, Standard Current (CC) method is used for loading. The CF, FREQ, +PF, -PF only can be operated in Standard Current (CC) method.

CF

Press the CF key, and $\sqrt{2}$ key settings will be automatically saved and exit.

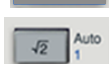

CF

Press the CF key, and 2 key settings will be automatically saved and exit.

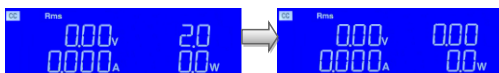



Press the CF key, and 2.5 key settings will be automatically saved and exit.

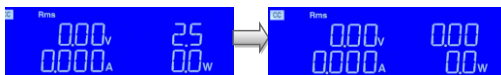

Press the CF key, and 3.0 key settings will be automatically saved and exit.

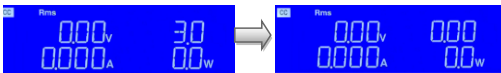

Press the CF key, and 3.5 key settings will be automatically saved and exit.

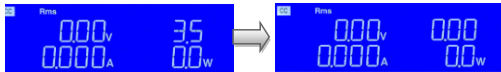
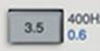

Press the CF key, setting range from 1.4 to 5.0, step 0.1 by rotating the Setting knob, press the ENTER key after the completion of the setting will be automatically stored.

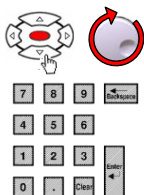

Note

The limitation is the peak current of specification, AEL-5000 series current specification is 37.5Arms/ 112.5A peak, so when you setting the CF of 5.0 the rms current setting should be limited to 22.5A

Example	Model	Nominal	CF 5.0 Limit
	AEL-5004-350-37.5	37.5A	22.5A
	AEL-5003-350-28	28A	16.8A
	AEL-5002-350-18.75	18.75A	11.25A
	AEL-5004-480-28	28A	16.8A
	AEL-5003-480-18.75	18.75A	11.25A

- Current phase modulation waveform load

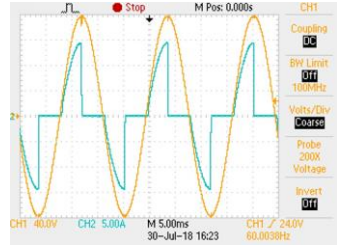

90 degree SCR Trailing edge current waveform

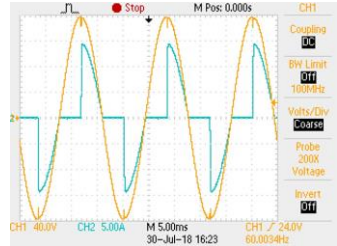

90 degree SCR Leading edge current waveform

- Positive half-cycle or negative half-cycle load setting use the knob and key to adjust the CF value, or press the CF key, the Keypad key enters 1.1 (LDNEG), the monitor displays LDNEG is negative half-cycle loading, the Keypad key enters 1.0 (LDPOS),LDPOS for positive half-cycle loading.

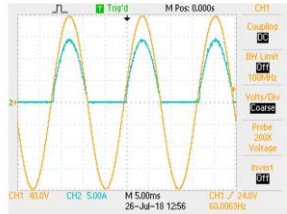
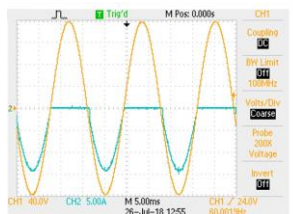
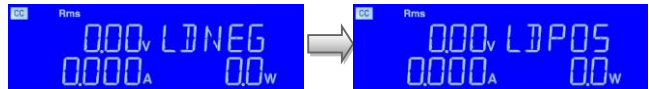

FREQ key and Auto, DC, 50Hz, 60Hz 400Hz keys



FREQ key only functions upon C.C. and C.P. mode and all LED off upon Linear C.C., C.R. and C.V. mode. Auto, DC, 50Hz, 60Hz and 400Hz keys are used to quick change the frequency of C.C. and C.P. mode. However, adjust the frequency by number key or Up, Down or rotary switch to setting the frequency values. The range is 40~440Hz.



Press the FREQ key, and Auto key settings will be automatically saved and exit.

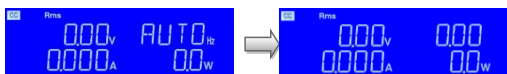
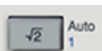

Press the FREQ key and DC key settings will be automatically saved and exit.

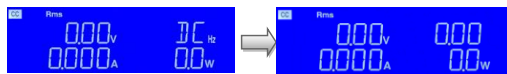

Press the FREQ key and 50Hz key settings will be automatically saved and exit.

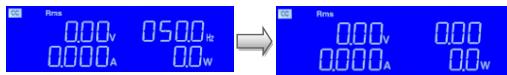

Press the FREQ key and 60Hz key settings will be automatically saved and exit.



Press the FREQ key and 400Hz key settings will be automatically saved and exit.

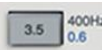

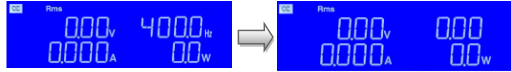

FREQ

Press the FREQ key, setting range from AUTO to 440Hz, step 0.1 by rotating the Setting knob, press the ENTER key after the completion of the setting will be automatically stored.

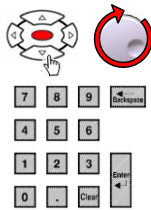

PF key and 1, 0.9, 0.8, 0.7, 0.6 keys

PF

PF (lead) key only functions upon C.C. and C.P. mode and all LED off upon Linear C.C., C.R. and C.V. mode.



1, 0.9, 0.8, 0.7 and 0.6 keys are used to quick change the P.F. (Crest Factor) of C.C. and C.P. mode.

However, adjust the PF by number key or Up, Down or rotary switch to setting the P.F. values. The range is 0 ~ 1.

PF

- Press the PF key and 1 key settings will be automatically saved and exit.

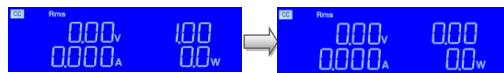
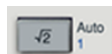

PF

- Press the PF key and 0.9 key settings will be automatically saved and exit.

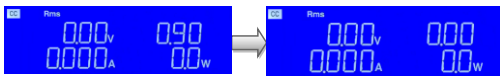

PF

- Press the PF key and 0.8 key settings will be automatically saved and exit.

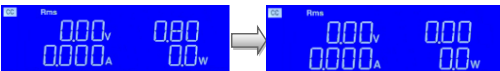
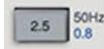

PF

- Press the PF key and 0.7 key settings will be automatically saved and exit.

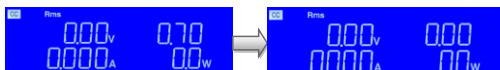

PF

- Press the PF key and 0.6 key settings will be automatically saved and exit.

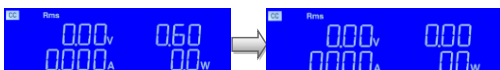

PF

- Press the PF key, setting range from 0.01 to 1.00, step 0.01 by rotating the Setting knob, press the ENTER key after the completion of the setting will be automatically stored.

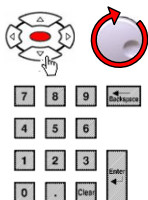

- Adjustment of PF

The adjustable range of PF will be different due to CF. Therefore, it is necessary to select the appropriate CF to make the PF setting value within the adjustable range (refer to the PF VS CF graph on page 79). When the PF setting value is not within the adjustable range under this CF setting value, the system will automatically adjust the CF setting value so that the PF setting value is as required by the user.

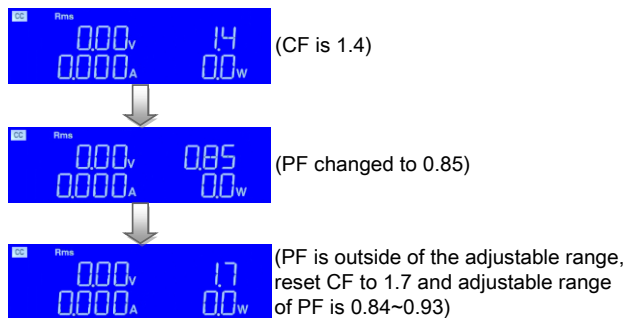

-PF key and 1, 0.9, 0.8, 0.7, 0.6 keys

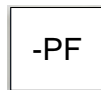

PF (lag) key only functions upon C.C. and C.P. mode and all LED off upon Linear C.C., C.R. and C.V. mode.



1, 0.9, 0.8, 0.7 and 0.6 keys are used to quick change the P.F. (Crest factor) of C.C. and C.P. mode.

However, adjust the PF by number key or Up, Down or rotary switch to setting the P.F. values. The range is 0 ~ -1.

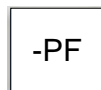

- Press the -PF key and 1 key settings will be automatically saved and exit.



-PF



- Press the -PF key and 0.9 key settings will be automatically saved and exit.

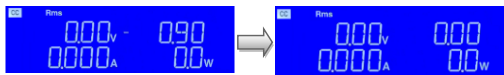

-PF



- Press the -PF key and 0.8 key settings will be automatically saved and exit.

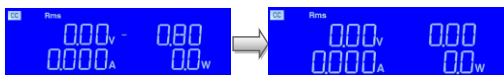

-PF



- Press the -PF key and 0.7 key settings will be automatically saved and exit.

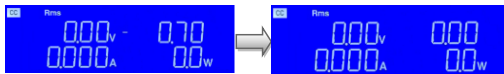

-PF



- Press the -PF key and 0.6 key settings will be automatically saved and exit.

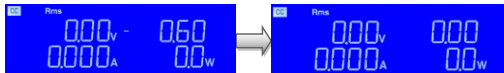

-PF

- Press the -PF key, setting range from -0.01 to -1.00, step 0.01 by rotating the Setting knob, press the ENTER key after the completion of the setting will be automatically stored.

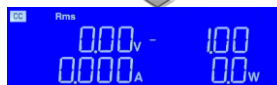
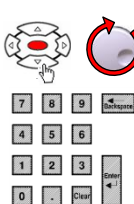

PF setting range, when CF is set to 2, the PF setting range is 0.55~0.8.

PF vs CF
curve
graph

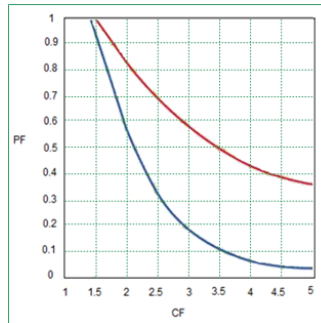

Test Function description



Item, Setting and Exit keys

Item

Setting

Exit

Item, Setting and Exit key for Test. There are ten operating modes. These can be selected in turn by pressing the "Item" key on the AEL-5000 series AC/DC Electronic Load module. The sequence is:

- SHORT
- OPP
- OCP
- Non-L
- NL+CR
- FUSE
- BATT
- TRANS
- INRUSH
- SURGE
- ITHD

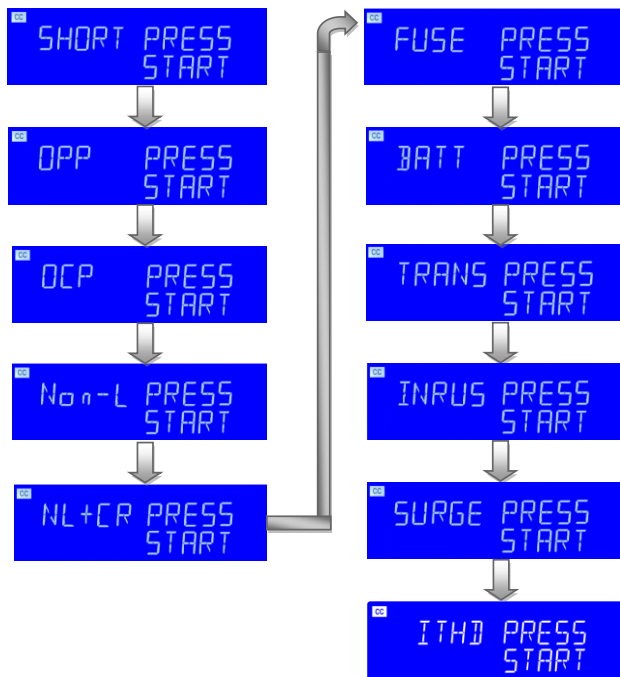

The SHORT parameters setting

The SHORT test will attempt to sink high current up to the AEL-5000 Series AC/DC load maximum current in order to check the power source’s protection and behavior. The test time can be adjusted and threshold values for the High and low voltage limits set.

Item

Pressing the Item key once will cause the button to illuminate. The Message “SHORT PRESS START” will be shown across the displays.

Setting

Each press of the Setting key moves the menu on one step. The left and right LCDs show the currently selected test parameter as text. The value is adjusted by the rotary knob and can be read from the right display during setting.

The setting sequence is shown below:

- SHORT PRESS START
- SHORT TURBO
- SHORT Time CONTI
- SHORT V HI
- SHORT V Lo

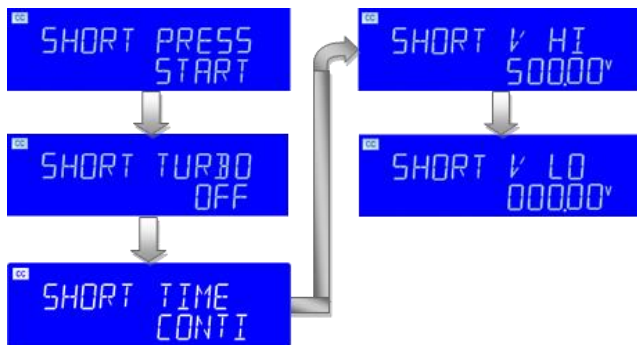

- The right upper 5 digit monitor display the Turbo and right lower monitor display "OFF", use the knob and the key to switch ON or OFF.

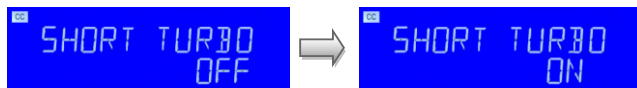

- The setting short test time, right upper 5 digit monitor display the TIME and right lower monitor display "CONTI", the setting range is "CONTI" means continue.



- SHORT TIME: setting the Short test time, the left 5 digit monitor display the "SHORT", the right upper 5 digit monitor display the TIME and right lower monitor display "100ms", the range is 100ms to 10000ms.
- The short test will be no time limitation when setting to CONTI until press "START/STOP" key to stop the short test.



Note

TURBO ON state, the test time up to 1000ms.



- V-Hi: Short test voltage check upper limitation setting, the Left 5 digit monitor display the "SHORT", the right upper 5 digit monitor display the "V-HI" and right lower monitor display setting value, the unit is "V". The range is 0.01V to 500.00V.

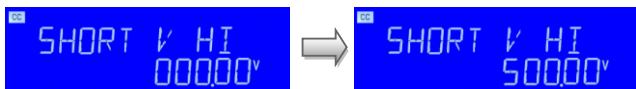

- V-Lo : Short test voltage check lower limitation setting, the Left 5 digit monitor display the "SHORT", the right upper 5 digit monitor display the "V-Lo" and right lower monitor display setting value, the unit is "V". The range is 0.01V to 500.00V.





Once the test parameters have been entered the test is started by pressing the red START/STOP button while the SHORT PRESS START text is displayed. During the test the bottom LCD will show run and the actual short current will be displayed on the right upper LCD.



Note

- The message PASS END will be displayed if the measured voltage levels stay within the V_{Hi} and V_{Lo} threshold levels during the test.
- The message FAIL END will be displayed if the measured voltage levels fall outside the V_{Hi} and V_{Lo} threshold levels during the test. The NG flag will also illuminate.
- If continuous short time is selected the test is ended by pressing the red START/STOP button.

OPP
parameters
setting

The OPP allows the parameters of an Over Power Protection test to be entered. The OPP test will ramp up the load power in steps to validate the Device under test's (DUT) protection and behavior. A voltage threshold level can be set. If the voltage measured during the test is lower than the set Threshold voltage then the test will fail and the display will signal OPP ERROR. Similarly a power threshold (P STOP) can be set. If the measured power reaches the P STOP threshold the test will be discontinued and the OPP ERROR message will be displayed.

Item

Pressing the Item key once will cause the button to illuminate. The message "OPP PRESS START" will be shown across the displays.

Setting

Each press of the Setting button moves the menu on one step. The Left and Middle LCDs show the currently selected test parameter as text. The value is adjusted by the rotary knob and can be read from the Right display during setting.

The setting sequence is shown below:

- OPP PRESS START
- OPP TURBO
- OPP PSTAR
- OPP PSTEP
- OPP PSTOP
- OPP VTH

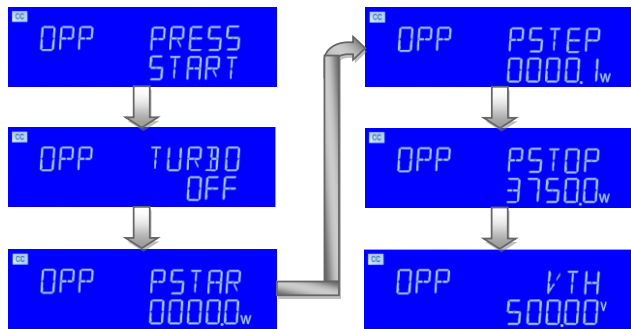

The right upper 5 digit monitor display the Turbo and right lower monitor display "OFF", use the knob and the key to switch ON or OFF.

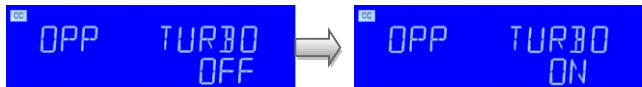

- PSTAR: setting the start power, the Left 5 digit monitor display the "OPP" ,the right upper 5 digit monitor display the "PSTAR", and right lower monitor display setting value, the unit is "W". The range is 0.1W to the full scale of the CP mode specification.

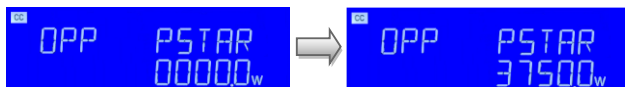

- PSTEP: setting the increment step power, the Left 5 digit monitor display the "OPP" ,the right upper 5 digit monitor display the "PSTEP", and right lower monitor display setting value, the unit is "W". The range is 0.1W to the full scale of the CP mode specification.

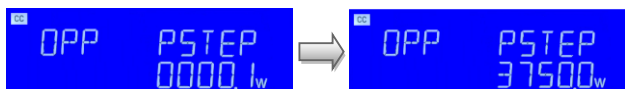

- PSTOP: setting the stop power, the Left 5 digit monitor display the "OPP" ,the right upper 5 digit monitor display the "PSTOP", and right lower monitor display setting value, the unit is "W". The range is 0.1W to the full scale of the CP mode specification.



Note

The maximum settable stop power in TURBO ON state is the "PSTAR + 10X PSTEP" power.

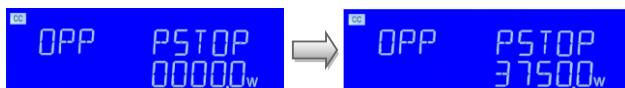

- Vth : Setting threshold voltage; the Left 5 digit monitor display the "OPP", the right upper 5 digit monitor display the "VTH", and right lower monitor display setting value, the unit is "V". The range is 0.01V to the full scale of the Voltage specification.

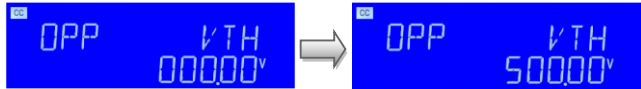

OC
parameters
setting

The OCP allows the parameters of an Over Current Protection test to be entered. The OCP test will ramp up the load current in steps to validate the Device Under test's (DUT) protection and behavior. A voltage threshold level can be set. If the voltage measured during the test is lower than the set Threshold voltage then the test will fail and the display will signal OCP ERROR. Similarly a current Threshold (I STOP) can be set. If the measured Current reaches the I STOP Threshold the test will be discontinued and the OCP ERROR message will be displayed.

Item

Pressing the Item key once will cause the button to illuminate. The message "OCP PRESS START" will be shown across the displays.

Setting

Each press of the setting button moves the menu on one step. The Left and right LCDs show the currently selected test parameter as text. The value is adjusted by the rotary knob and can be read from the Right display during setting.

The setting sequence is shown below:

- OCP PRESS START

- OCP TURBO
- OCP ISTAR
- OCP ISTEP
- OCP ISTOP
- OCP VTH

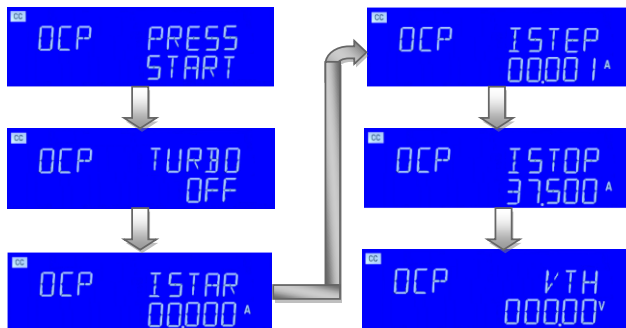

- The right upper 5 digit monitor display the Turbo and right lower monitor display "OFF", use the knob and the key to switch ON or OFF.

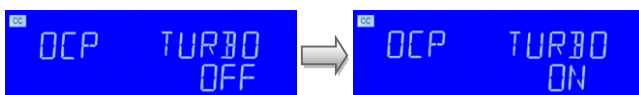

- ISTAR: setting the start current point, the Left 5 digit monitor display the "OCP", the right upper 5 digit monitor display the "ISTAR", and right lower monitor display setting value, the unit is "A". The range is 0.001A to the full scale of the CC mode specification.

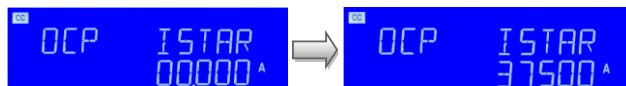

- ISTEP: setting the increment step current point, the Left 5 digit monitor display the "OCP", the right upper 5 digit monitor display the "ISTEP", and right lower monitor display setting value, the unit is "A". The range is 0.001A to the full scale of the CC mode specification.

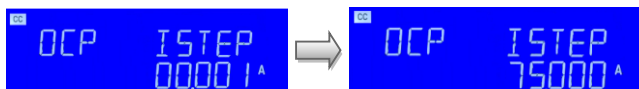

- ISTOP: setting the stop current point, the Left 5 digit monitor display the "OCP", the right upper 5 digit monitor display the "ISTOP", and right lower monitor display setting value, the unit is "A". The range is 0.001A to the full scale of the CC mode specification. TURBO ON state, the maximum stop current that can be set is "ISTAR + 10X ISTEP current value.

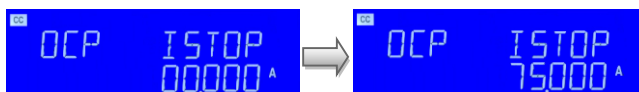

- Vth: Setting threshold voltage; the Left 5 digit monitor display the "OCP", the right upper 5 digit monitor display the "VTH", and right lower monitor display setting value, the unit is "V". The range is 0.01V to the full scale of the Voltage specification.

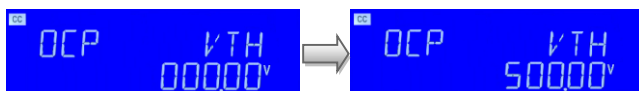



Once the test parameters have been entered the test is started by pressing the red START/STOP button while the OCP PRESS START text is displayed. During the Test the middle LCD will show run and the actual current being Taken will be displayed on the Right LCD



Note

The message OCP ERROR will be displayed if the DUT fails the test. The reasons for failure are due to one of the following conditions:

- (a) The voltage level of the DUT falls below the set voltage threshold (OCP Vth) during the test
- (b) The current taken from the DUT reaches the OCP I STOP setting.

The message PASS will be displayed if the DUTs voltage stays above the set threshold. Also to PASS the OCP test the current taken from the DUT cannot equal the I STOP setting.

If the DUT passes the OCP test the maximum current taken during the test is displayed on the right LCD. Upon PASS or OCP ERROR the test will automatically stop. The red START/STOP button can be used during the test to immediately cease operation.

The Non-L parameters setting



Pressing the Item key once will cause the button to illuminate. The message "Non-L PRESS START" will be shown across the displays.



Each press of the setting button moves the menu on one step. The Left and right LCDs show the currently selected test parameter as text. The value is adjusted by the rotary knob and can be read from the Right display during setting.

The setting sequence is shown below:

- Non-L PRESS START
- Non-L CC

- Non-L PF

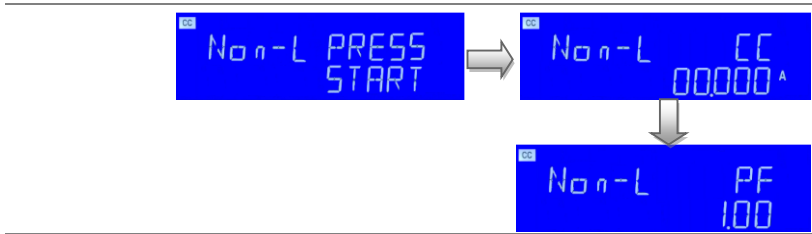

- Non-L CC: setting the Non-L current point, the Left 5 digit monitor display the “Non-L”, the right upper 5 digit monitor display the “CC”, and right lower monitor display setting value, the unit is “A”. The range is 0.001A to the full scale of the CC mode specification.

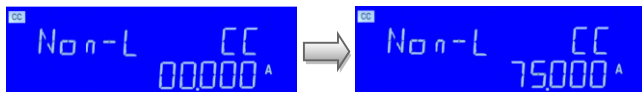

- Non-L PF: setting the PF, the Left 5 digit monitor display the “Non-L”, the right upper 5 digit monitor display the “PF”, and right lower monitor display setting value, The range is 0.01 ~ 1.00.

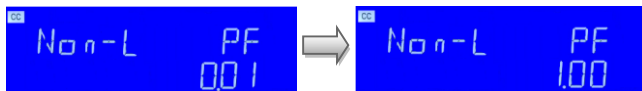

The NL+CR parameters setting

Item

Pressing the Item key once will cause the button to illuminate. The message “NL+CR PRESS START” will be shown across the displays.

Setting

Each press of the setting button moves the menu on one step. The Left and right LCDs show the currently selected test parameter as text. The value is adjusted by the rotary knob and can be read from the Right display during setting.

The setting sequence is shown below:

- NL+CR PRESS START
- NL+CR CC
- NL+CR CR

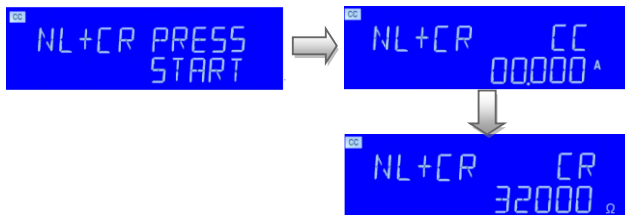

- NL+CR CC: setting the NL+CR CC current point, the Left 5 digit monitor display the “NL+CR”, the right upper 5 digit monitor display the “CC”, and right lower monitor display setting value, the unit is “A”. The range is 0.000A to the full scale of the CC mode specification.

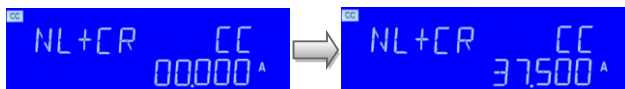

- NL+CR CR: setting the NL+CR CR resistance point, the Left 5 digit monitor display the “NL+CR”, the right upper 5 digit monitor display the “CR”, and right lower monitor display setting value, the unit is “Ω”. The range is 1.6000Ω to the full scale of the CR mode specification.

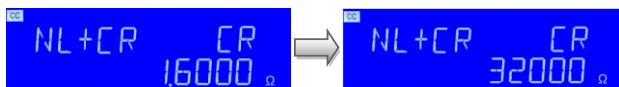

The FUSE parameters setting



Pressing the Item key once will cause the button to illuminate. The message “FUSE PRESS START” will be shown across the displays.

Setting

Each press of the Setting button moves the menu on one step. The Left and right LCDs show the currently selected test parameter as text. The value is adjusted by the rotary knob and can be read from the Right display during setting.

The setting sequence is shown below:

- FUSE PRESS START
- FUSE TURBO OFF
- FUSE STEP
- FUSE CC1
- FUSE TIME1
- FUSE CC2
- FUSE TIME2
- FUSE CC3
- FUSE TIME3
- FUSE T OFF
- FUSE CYCLE
- FUSE TYPE

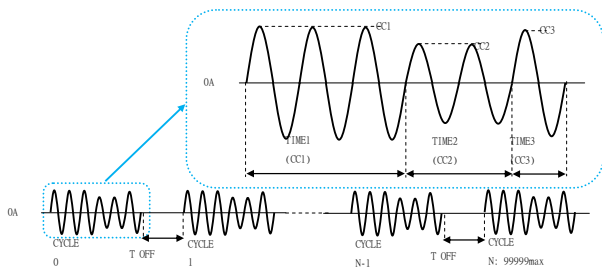
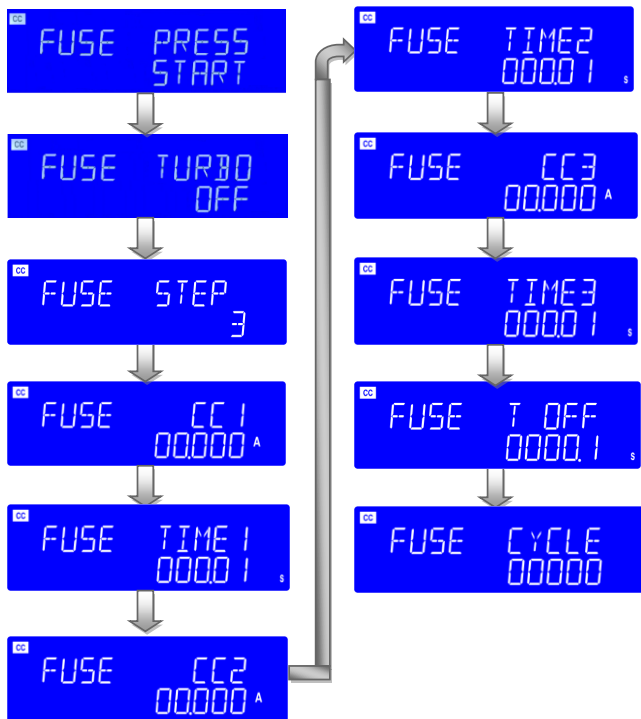

- Setting the fuse TURBO, The Left 5 digit monitor display the “FUSE”, the Right Upper 5 Digit monitor display the “TURBO”, and right lower monitor Display OFF; Use the knob and the key to ON or OFF.
 OFF: The current of CC1/2/3 is set to the rated current.

ON: The CC1/2 current is set to twice the rated current; in this case, the time is set as follows.

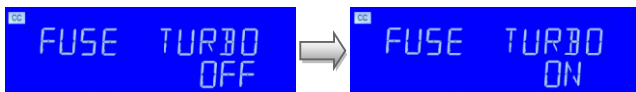

- Set the FUSE STEP, the 5-digit display on the left displays "FUSE", the 5-digit display on the upper right displays "STEP", use the knob or button to set STEP1~3, STEP 1 means use CC1, STEP2 means use CC1+CC2, STEP 3 means use CC1+CC2+CC3 (initial value is 1)

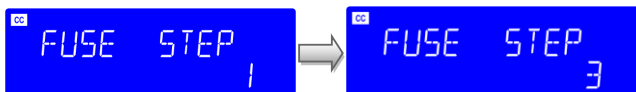

- FUSE CC1: setting the fuse current point, the Left 5 digit monitor display the "FUSE", the right upper 5 digit monitor display the "CC1", and right lower monitor display setting value, the unit is "A", Use the knob and button to set the FUSE CC1 current value, Turbo mode OFF, set range from 0.000A to full scale current of the CC mode specification.

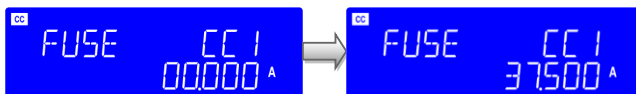

Turbo mode ON full scale current x2 resolution is 0.001A

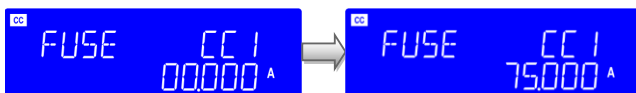

- FUSE TIME1: setting the fuse test time, the Left 5 digit monitor display the "FUSE", the right upper 5 digit monitor display the "TIME1", and right lower monitor display setting value, the unit is "S". Use the knob and button to set the range from 0.01S ~333.33S.
- Turbo Mode OFF: 0.01S-333.33S / 0.01S

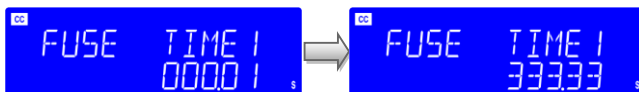

Turbo Mode ON: 0.01S-0.50S / 0.01S

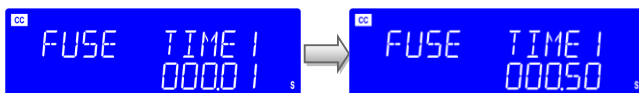

- FUSE CC2: setting the fuse current point, the Left 5 digit monitor display the "FUSE", the right upper 5 digit monitor display the "CC2", and right lower monitor display setting value, the unit is "A", Use the knob and button to set the FUSE CC2 current value, Turbo mode OFF, set range from 0.000A to full scale current of the CC mode specification.

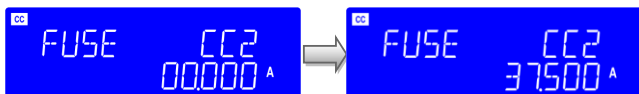

Turbo mode ON full scale current x2
resolution is 0.001A

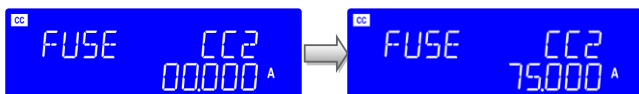

- FUSE TIME2: setting the fuse test time, the Left 5 digit monitor display the "FUSE", the right upper 5 digit monitor display the "TIME2", and right lower monitor display setting value, the unit is "S". Set the range and resolution as follows.
- Turbo Mode OFF: 0.01S-333.33S / 0.01S

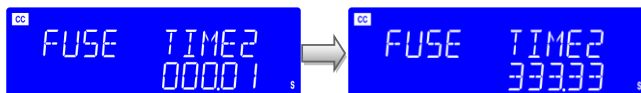

Turbo Mode ON: 0.01S-0.50S / 0.01S

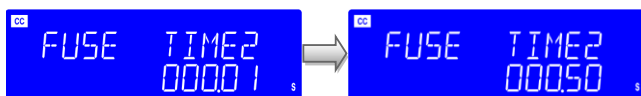

- FUSE CC3: setting the fuse current point, the Left 5 digit monitor display the "FUSE", the right upper 5 digit monitor display the "CC3", and right lower monitor display setting value, the unit is "A", Use the knob and button to set the FUSE CC3 current value, Turbo mode ON or OFF, set range from 0.000A to full scale current of the CC mode specification.

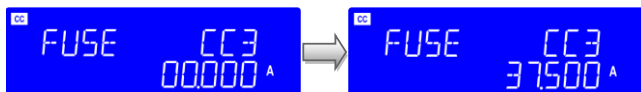

- FUSE TIME3: setting the fuse test time, the Left 5 digit monitor display the "FUSE", the right upper 5 digit monitor display the "TIME3", and right lower monitor display setting value, the unit is "S". Set the range and resolution as follows.
- Turbo Mode OFF: 0.01S-333.33S / 0.01S

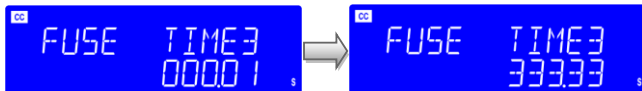

Turbo Mode ON: 0.01S-600.00S / 0.01S

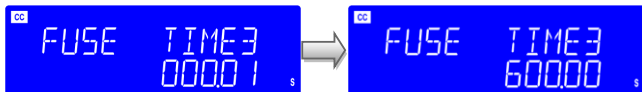

- FUSE T OFF: setting the fuse T OFF time, the Left 5 digit monitor display the “FUSE”, the right upper 5 digit monitor display the “T OFF”, and right lower monitor display setting value, the unit is “S”. Set the interval time (T OFF) of the current repeated test, use the knob and button to set the time, the setting range is from 0.1S to 9999.9S.

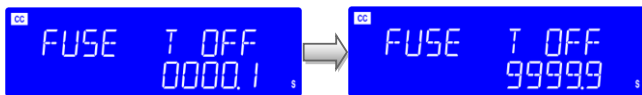

- FUSE CYCLE: setting the fuse cycle, the Left 5 digit monitor display the “FUSE”, the right lower 5 digit monitor display the “Test Cycle”, and right lower monitor display setting value. Use the knob and button to set the time, range from 0 to 99999.

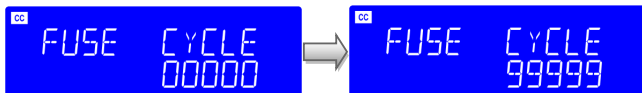

- The right upper 5 digit monitor display the TYPE and right lower monitor display “TRIP”, use the knob and the key to TRIP or NTRIP.

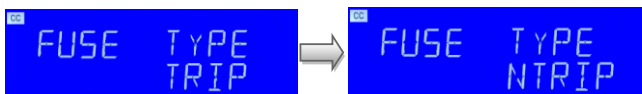

The BATT parameters setting

Item

Pressing the Item key once will cause the button to illuminate. The message "BATT PRESS START" will be shown across the displays.

In the battery test mode, the test will be terminated when the set conditions are reached.

For example, the voltage drops to UVP or the load time reaches the set time, so as to achieve the three battery test modes.

Pressing the Item key once will cause the button to illuminate. The message "BATT PRESS START" will be shown across the displays.

Setting

Each press of the setting button moves the menu on one step. The Left and right LCDs show the currently selected test parameter as text. The value is adjusted by the rotary knob and can be read from the Right display during setting.

The setting sequence is shown below:

- BATT PRESS START
- BATT FREQ
- BATT MODE CC
- BATT CC
- BATT CF
- BATT PF LEAD
- BATT PF
- BATT TIME
- BATT VTH

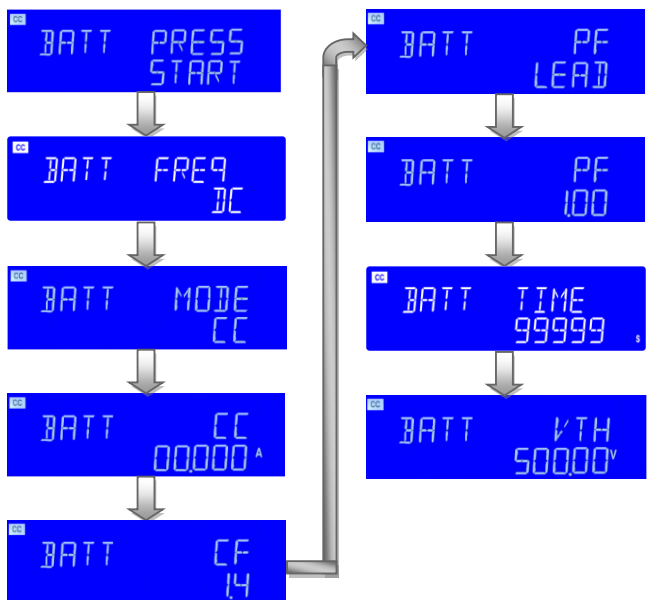

- BATT FREQ: the Left 5 digit monitor display "BATT", the right upper 5 digit monitor display "FREQ". Use the knob and button to switch over AC/DC.

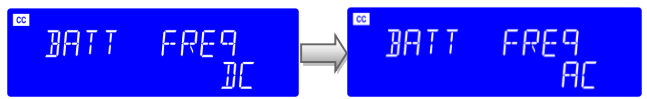

- The Left 5 digit monitor display the "BATT", the right upper 5 digit monitor Display the "MODE", and right lower monitor display the "CC", use the knob and the key to switch CC, LIN, CR or CP.

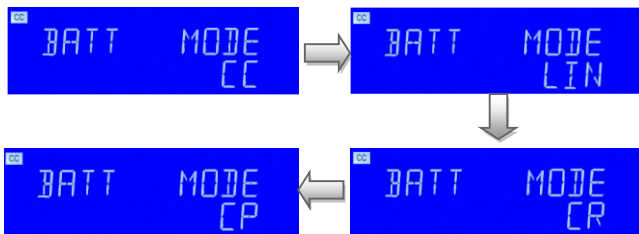

- BATT CC : setting the battery current point, the Left 5 digit monitor display the "BATT", the right upper 5 digit monitor display the "CC", and right lower monitor display setting value, the unit is "A". The range is 0.001A to the full scale of the CC mode specification.

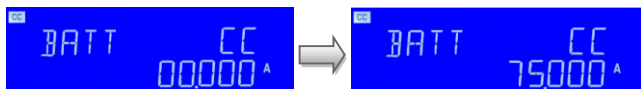

- BATT CF: setting the CF, the Left 5 digit monitor display the "BATT", the right upper 5 digit monitor display the "CF", and right lower monitor display setting value. The range is 1.0, 1.1, 1.2, 1.3, 1.4~5.0.

The setting sequence is shown below:

- BATT CF 1.4 ~5.0
- (1.3) BATT CF TRAIL: Trailing edge
- (1.2) BATT CF LEAD: Leading edge
- (1.1) BATT CF LDNEG: negative half-cycle loading
- (1.0) BATT CF LDPOS: positive half-cycle loading

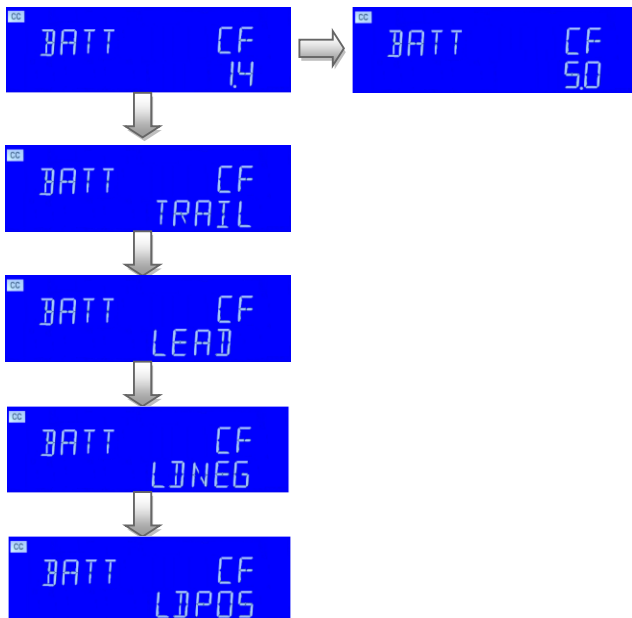

- The left 5 digit monitor display the “BATT”, the right upper 5 digit monitor display the “PF”, and right lower monitor display the “LEAD”, use the knob and the key to LEAD or LAG.

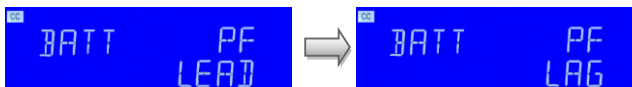

- BATT CF: setting the PF, the Left 5 digit monitor display the “BATT” ,the right upper 5 digit monitor display the “PF”, and right lower monitor display setting value. The range is 0.01 ~1.00.

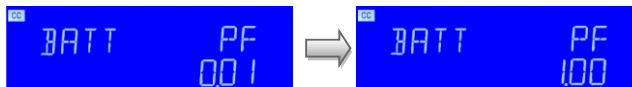

- BATT TIME: setting the Battery test time, the Left 5 digit monitor display the "BATT", the right upper 5 digit monitor display the "TIME", and right lower monitor display setting value, the unit is "S". The range is 1S ~99999S.

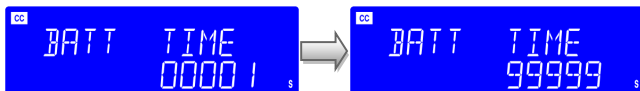

- BATT VTH: the Left 5 digit monitor display the "BATT", the right upper 5 digit monitor display the "VTH", and right lower monitor display setting value, the unit is "V". The range is 0.01V to the full scale of the Voltage specification.

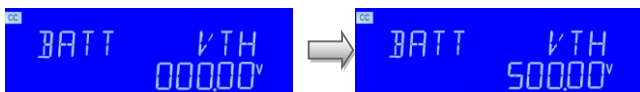

Item

Setting

Exit

Press the Item key to enter the Item setting mode BATT PRESS START, the LED indicator is ON, and then press the Setting key. The LED indicator is ON. To exit the setting, press the EXIT key and select LIN MODE.

The setting sequence is as follows:

- BATT PRESS START
- BATT Freq
- BATT MODE LIN
- BATT LIN
- BATT TIME
- BATT VTH

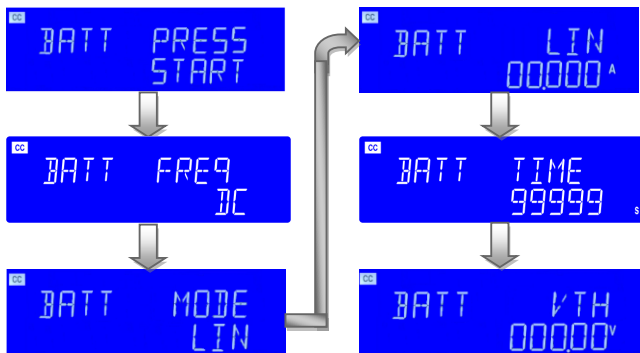

- BATT FREQ: the Left 5 digit monitor display “BATT”, the right upper 5 digit monitor display “FREQ”. Use the knob and button to switch over AC/DC.

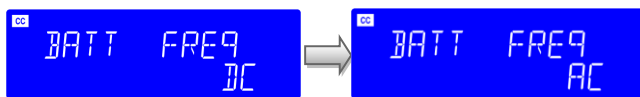

- BATT LIN : setting the BATT LIN, the Left 5 digit monitor display the “BATT” ,the right upper 5 digit monitor display the “LIN”, and right lower monitor display setting value, the unit is “A”. The range is 0.001A to the full scale of the CC mode specification.

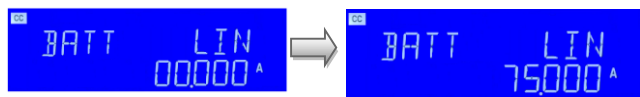

- BATT TIME: setting the BATT TIME, the Left 5 digit monitor display the “BATT” ,the right upper 5 digit monitor display the “TIME”, and right lower monitor display setting value, the unit is “S”. The range is 1s to the 99999s.

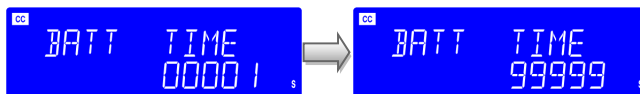

- BATT Vth: Setting BATT threshold voltage; the Left 5 digit monitor display the "BATT", the right upper 5 digit monitor display the "VTH", and right lower monitor display setting value, the unit is "V". The range is 0.01V to the full scale of the Voltage specification.

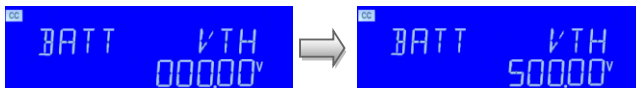

Item

Press the Item key to enter the Item setting mode BATT PRESS START, the LED indicators is ON, and then press the setting key. The LED indicator is ON. To exit the setting, press the EXIT key and select CR MODE.

Setting

Exit

The setting sequence is as follows:

- BATT PRESS START
- BATT Freq
- BATT MODE CR
- BATT CR
- BATT TIME
- BATT VTH

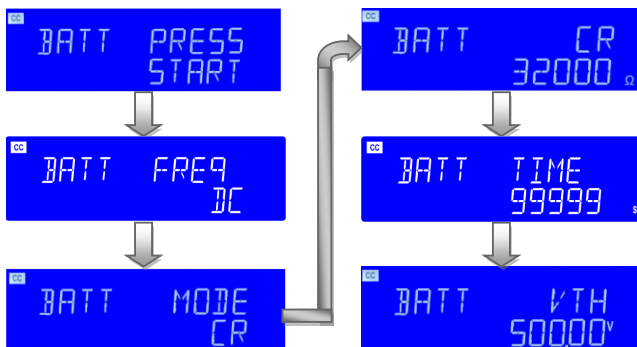

- BATT FREQ: the Left 5 digit monitor display "BATT", the right upper 5 digit monitor display "FREQ". Use the knob and button to switch over AC/DC.

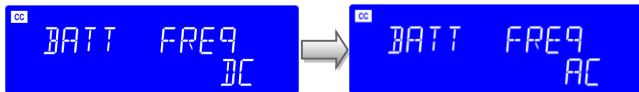

- BATT CR : setting the BATT CR, the Left 5 digit monitor display the "BATT" ,the right upper 5 digit monitor display the "CR", and right lower monitor display setting value, the unit is "Ω". The range is 1.6Ω to the full scale of the CR mode specification.

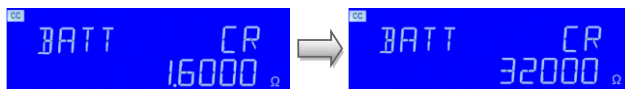

- BATT TIME: setting the BATT TIME, the Left 5 digit monitor display the "BATT" ,the right upper 5 digit monitor display the "TIME", and right lower monitor display setting value, the unit is "S". The range is 1s to the 99999s.

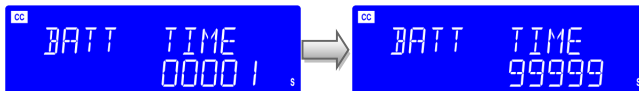

- BATT Vth: Setting BATT threshold voltage; the Left 5 digit monitor display the "BATT" ,the right upper 5 digit monitor display the "VTH", and right lower monitor display setting value, the unit is "V". The range is 0.01V to the full scale of the Voltage specification.

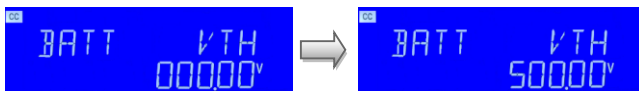

Item

Press the Item key to enter the Item setting mode BATT PRESS START, the LED indicators is ON, and then press the Setting key. The LED indicator is ON. To exit the setting, press the EXIT key and select CP MODE.

Setting

Exit

The setting sequence is as follows:

- BATT PRESS START
- BATT Freq DC
- BATT MODE CP
- BATT CP
- BATT CF
- BATT PF LEAD
- BATT PF
- BATT TIME
- BATT VTH

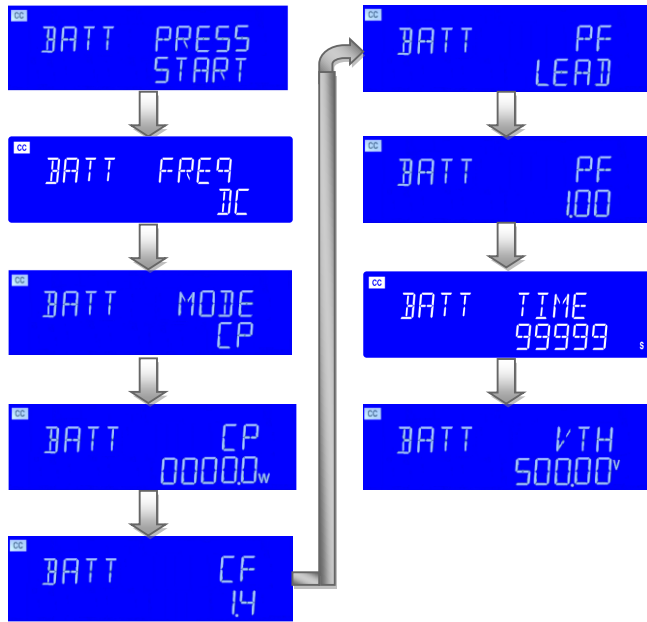

- BATT FREQ: the Left 5 digit monitor display “BATT”, the right upper 5 digit monitor display “FREQ”. Use the knob and button to switch over AC/DC.

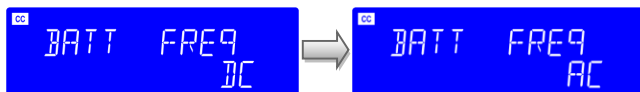

- BATT CP: setting the BATT CP, the Left 5 digit monitor display the “BATT”, the right upper 5 digit monitor display the “CP”, and right lower monitor display setting value, the unit is “W”. The range is 0.1W to the full scale of the CP mode specification.

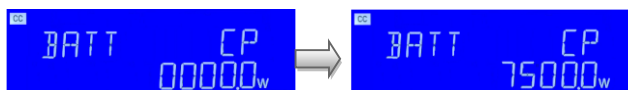

- BATT CF: setting the CF, the Left 5 digit monitor display the “BATT”, the right upper 5 digit monitor display the “CF”, and right lower monitor display setting value. The range is 1.0, 1.1, 1.2, 1.3, 1.4 ~5.0.

The setting sequence is shown below:

- BATT CF 1.4 ~5.0
- (1.3) BATT CF TRAIL: Trailing edge
- (1.2) BATT CF LEAD: Leading edge
- (1.1) BATT CF LDNEG: negative half-cycle loading
- (1.0) BATT CF LDPOS: positive half-cycle loading

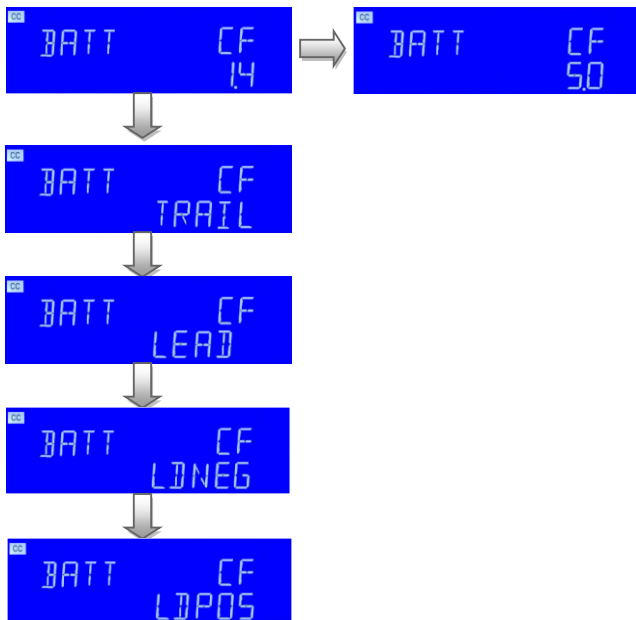

- BATT CF: setting the PF, the Left 5 digit monitor display the “BATT” ,the right upper 5 digit monitor display the “PF” , and right lower monitor display setting value. The range is 0.01 ~1.00.

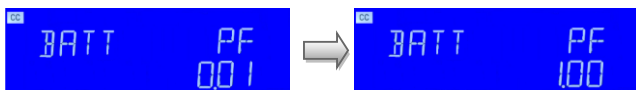

- BATT TIME: setting the Battery test time, the Left 5 digit monitor display the “BATT” ,the right upper 5 digit monitor display the “TIME” , and right lower monitor display setting value, the unit is “S” . The range is 1S ~99999S.

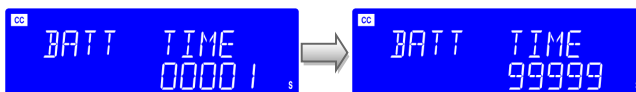

- BATT VTH: the Left 5 digit monitor display the "BATT", the right upper 5 digit monitor display the "VTH", and right lower monitor display setting value, the unit is "V". The range is 0.01V to the full scale of the Voltage specification.

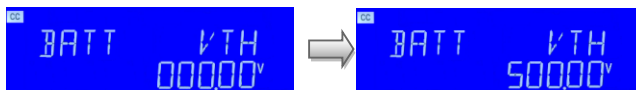

The TRANS parameters setting

Item

TRANS is used to test the time when the UPS is switched to battery power after the electricity power is cut off.

Pressing the Item key once will cause the button to illuminate. The message "TRANS PRESS START" will be shown across the displays.

Setting

Each press of the Setting button moves the menu on one step. The Left and right LCDs show the currently selected test parameter as text. The value is adjusted by the rotary knob and can be read from the Right display during setting.

The setting sequence is shown below:

- TRANS PRESS START
- TRANS CC

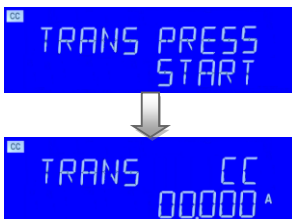

- TRANS CC : setting the Battery current point, the Left 5 digit monitor display the "TRANS", the right upper 5 digit monitor display the "CC", and right lower monitor display setting value, the unit is "A". The range is 0.001A to the full scale of the CC mode specification.

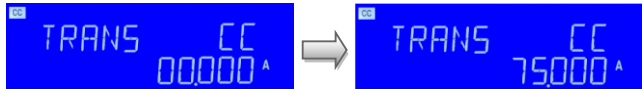

The INRUS parameters setting

Item

Pressing the Item key once will cause the button to illuminate. The message "INRUS PRESS START" will be shown across the displays.

Setting

Each press of the setting button moves the menu on one step. The Left and right LCDs show the currently selected test parameter as text. The value is adjusted by the rotary knob and can be read from the right display during setting.

When MODE is selected "CC", its setting sequence is as follows:

- INRUS PRESS START
- INRUS MODE
- INRUS FREQ
- INRUS DEGRE
- INRUS IPEAK
- INRUS ISTAR
- INRUS ISTEP
- INRUS CYCLE or INRUS TIME
- INRUS ISTOP

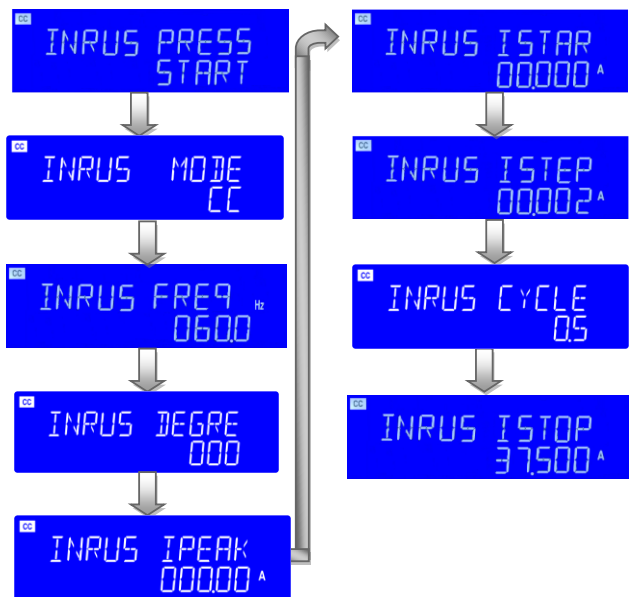

- **INRUS MODE:** Setting the INRUS MODE, the left 5-digit monitor display the "INRUS", the right 5-digit monitor display the "MODE", and the lower 5-digit monitor display setting value, use the knob and button to set CC or CR.

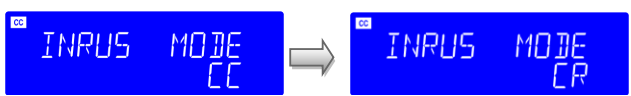

- **INRUS FREQ:** setting the INRUS FREQ, the Left 5 digit monitor display the "INRUS", the right upper 5 digit monitor display the "FREQ", and Right lower monitor display setting value, the unit is "Hz", use the knob and button to set the Range from DC and 40~ 440Hz.

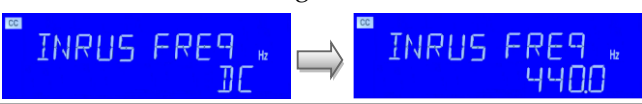

- INRUS DEGRE: Setting the INRUS DEGRE, the left 5-digit monitor display the "INRUS", the right 5-digit monitor display the "DEGRE", and the lower 5-digit monitor display setting value, use the knob and button to set the angle value, the setting range from 0 to 359.

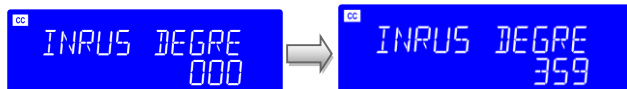

- INRUS IPEAK: setting the INRUS IPEAK, the left 5-digit monitor display the "INRUS", the right 5-digit monitor display the "IPEAK", and the lower 5-digit monitor display setting value, the unit is "A". Use the knob and button to set the starting current value, the setting range from 0.000 A to 112.50A.

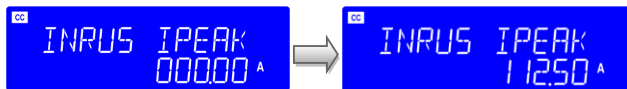

- INRUS ISTAR: setting the INRUS ISTAR, the Left 5 digit monitor display the "INRUS", the right upper 5 digit monitor display the "ISTAR", and right lower monitor display setting value, the unit is "A". Use the knob and button to set the starting current value, the setting range from 0.000A to 75.000A.

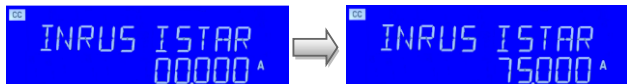

- INRUS ISTEP : setting the INRUS ISTEP, the Left 5 digit monitor display the “INRUS”, the right upper 5 digit monitor display the “ISTEP”, and right lower monitor display setting value, the unit is “A”. Use the knob and button to set the ISTEP current value, the setting range from 0.000 A to 75.000A.

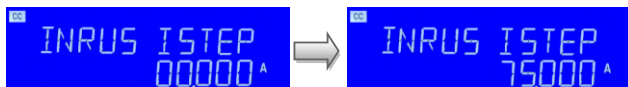

- At Frequency 40-440Hz (AC), setting the INRUS CYCLE, the left 5-digit monitor display the “INRUS”, the right 5-digit monitor display the “CYCLE”, and the lower 5-digit monitor display setting value, use the knob and button to set the range from 0 to 5.0.

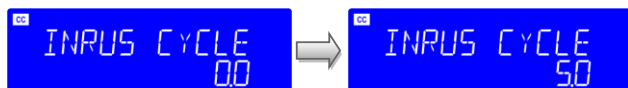

- At Frequency 0 Hz (DC), set the INRUS TIME, the left 5-digit monitor display “INRUS”, the right 5-digit monitor display “TIME”, and the lower 5-digit monitor display setting value, the unit is “ms”. Use the knob and button to set the time, the setting range from 0.1ms to 100.0ms.

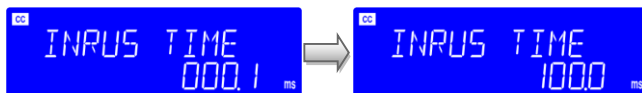

- INRUS ISTOP: setting the INRUS ISTOP, the Left 5 digit monitor display the "INRUS", the right upper 5 digit monitor display the "ISTOP", and right lower monitor display setting value, the unit is "A". Use the knob and button to set the ISTOP current value, the setting range from 0.000 A to 37.500A.



Item

Press the Item key to enter the Item setting "INRUS PRESS START", the LED indicator will illuminate. Next, press the setting key, the LED indicator will illuminate. Press EXIT key to leave the setting. When the MODE is selected "CR", the setting sequence is as follows:

- INRUS PRESS START
- INRUS MODE
- INRUS RSTAR
- INRUS RSTEP
- INRUS TIME
- INRUS ISTOP

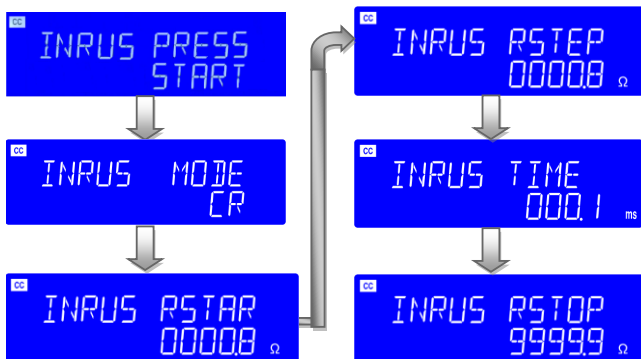

- INRUS RSTAR: Setting the INRUS RSTAR, the left 5-digit monitor display the “INRUS”, the right 5-digit monitor display the “RSTAR”, and the lower 5-digit monitor display setting value, the unit is “ Ω ”. Use the knob and button to set the resistance value, range from 0.8Ω to 9999.9Ω .

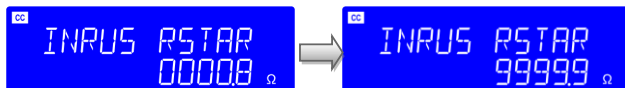

- INRUS RSTEP: Setting the INRUS RSTEP, the left 5-digit monitor display the “INRUS”, the right 5-digit monitor display the “RSTEP”, and the lower 5-digit monitor display setting value, the unit is “ Ω ”. Use the knob and button to set the resistance value, range from 0.8Ω to 9999.9Ω .

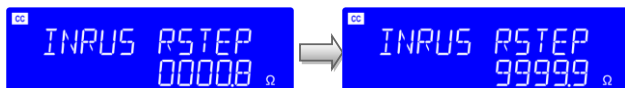

- INRUS TIME: Setting the INRUS TIME, the Left 5 digit monitor display the “INRUS”, the right upper 5 digit monitor display the “TIME”, and right lower monitor display setting value, the unit is “ms”. Use the knob and button to set the time, the setting range from 0.1ms to the 100.0ms .



The SURGE parameters setting

Item

Pressing the Item key once will cause the button to illuminate. The message “SURGE PRESS START” will be shown across the displays.

Setting

Each press of the setting button moves the menu on one step. The Left and right LCDs show the currently selected test parameter as text. The value is adjusted by the rotary knob and can be read from the Right display during Setting.

The setting sequence is shown below:

- SURGE PRESS START
- SURGE FREQ
- SURGE S1
- SURGE T1
- SURGE S2
- SURGE T2
- SURGE S3
- SURGE T3

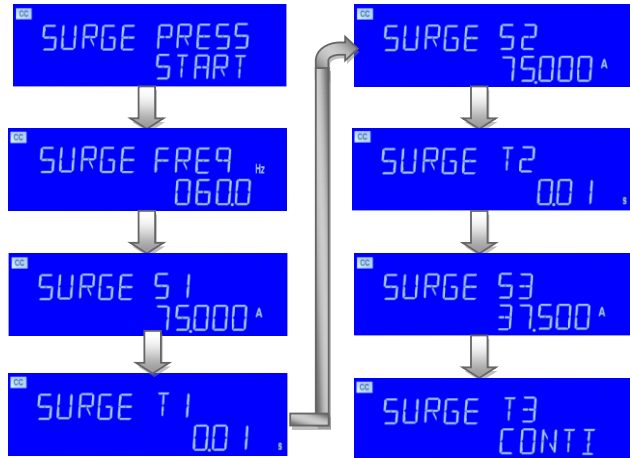

- SURGE FREQ: setting the SURGE FREQ, the Left 5 digit monitor display the "SURGE", the right upper 5 digit monitor display the "FREQ", and Right lower monitor display setting value, the unit is "Hz", use the knob and button to set the Frequency value, the setting

range from DC and 40~ 440Hz.

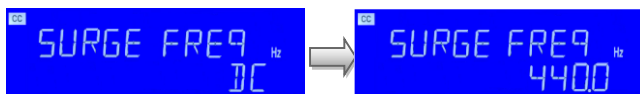

- SURGE S1: setting the SURGE S1, the Left 5 digit monitor display the "SURGE", the right upper 5 digit monitor display the "S1", and right lower monitor display setting value, the unit is "A", use the knob and button to set the first surge current value, the setting range from 0.000A to the 75.000A.

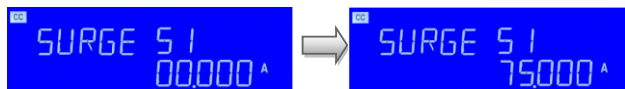

- SURGE T1: setting the SURGE T1, the Left 5 digit monitor display the "SURGE", the right upper 5 digit monitor display the "T1", and right lower monitor display setting value, the unit is "S", use the knob and button to set the first surge current time value, the setting range from 0.01s to the 0.50s.

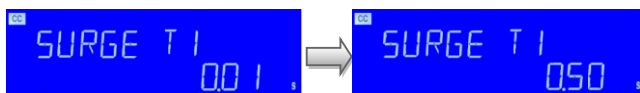

- SURGE S2: setting the SURGE S2, the Left 5 digit monitor display the "SURGE", the right upper 5 digit monitor display the "S2", and right lower monitor display setting value, the unit is "A", use the knob and button to set the second surge current value, the setting range from 0.000A to the 75.000A.

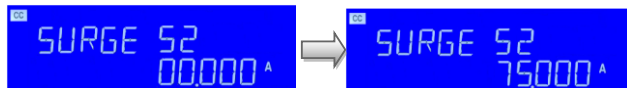

- SURGE T2: setting the SURGE T2, the Left 5 digit monitor display the "SURGE", the right upper 5 digit monitor display the "T2", and right lower monitor display setting value, the unit is "S", use the knob and button to set the second surge current time value, the setting range from 0.01s to the 0.50s.

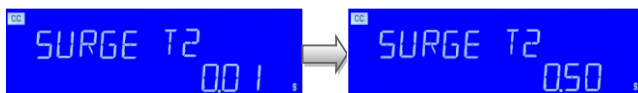

- SURGE S3: setting the SURGE S3, the Left 5 digit monitor display the "SURGE", the right upper 5 digit monitor display the "S3", and right lower monitor display setting value, the unit is "A", use the knob and button to set the Third surge current value, the setting range from 0.000A to the 37.500A.

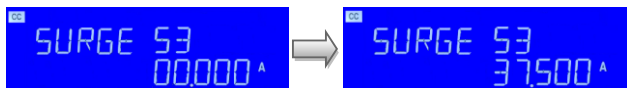

- SURGE T3: setting the SURGE T3, the Left 5 digit monitor display the "SURGE", the right upper 5 digit monitor display the "T3", and right lower monitor display setting value, the unit is "S", use the knob and button to set the third surge current time value, the setting range from CONTI to the 9.99s.

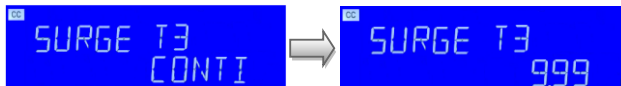

Item

Press the Item key to enter the setting mode "ITHD PRESS START", the LED indicator will illuminate. Next, press the setting key, the LED indicator will illuminate. Press EXIT key to leave the setting. The sequence is as follows:

- ITHD PRESS START
- ITHD 00%
- ITHD CC

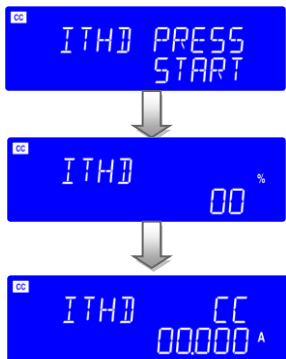

- ITHD percentage: The Left 5 digit monitor display the "ITHD", the right 5 digit monitor display the "%", and right lower monitor display setting value, adjusted by the rotary knob and arrow key. The setting range is from 00% to 25%.

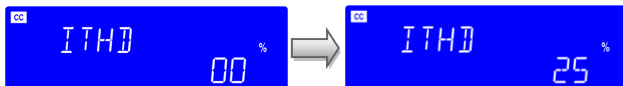

- ITHD CC Mode: The Left 5 digit monitor display the "ITHD", the right 5 digit monitor display the "CC", and the lower monitor display setting value, adjusted by the rotary knob and arrow key. The setting range is from 00.000A to 37.500A.



Start/Stop Key



The red START/STOP key is used in conjunction with the SHORT, OCP, OPP, Non-L, NL+CR, FUSE, BATT, TRANS test functions. It is used to START a test according to the set parameters or to STOP a test before PASS or FAIL is signaled. Please refer to the preceding sections for more information on the SHORT, OCP, OPP, Non-L, NL+CR, FUSE, BATT, TRANS tests.

Entry key description



Rotary Knob and ARROW Keys The ROTARY knob and ARROW keys are used to increase or decrease the set values.

		<ul style="list-style-type: none"> • Clockwise the rotary switch and UP arrow key to increase the setting values.
		<ul style="list-style-type: none"> • Anti-clockwise the rotary switch and DOWN arrow key to decrease the setting values.
		<ul style="list-style-type: none"> • Keypad KEY: When using the Keypad, please enter the number, press the Enter key.

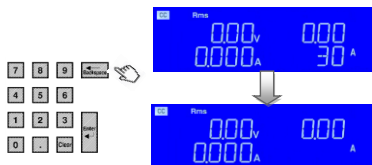

- Backspace KEY: Setting, press the Clear key to clear the input value.



In CR mode, increase setting value define for current value, so clockwise the rotary switch and press UP key will decrease the resistance value to increase the current value. Anti-clockwise the rotary switch and press DOWN key will increase the resistance value to decrease the current value.

C ONNECTION

Rear Panel	125
Master/Slave Description	128
2 operating modes for Master/Slave	130
Boost mode	130
3PH mode	131
REMOTE operating.....	135

Rear Panel

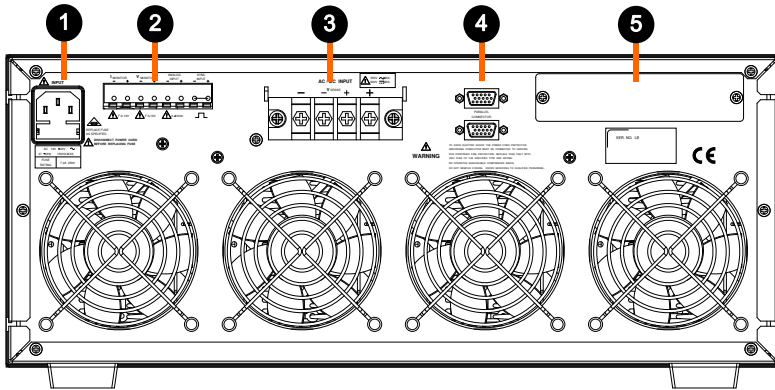

-
- 1 AC power input connector
 - 2 Vmonitor, Imonitor, Analog input, SYNC input terminal
 - 3 Vload, Vsense Input terminal
 - 4 Master-Slave control connector
 - Master: Connect the top or bottom to the next unit
 - Slave: The top connects to the previous unit and the bottom connects to the next unit
 - 5 Communication interface (GPIB, RS-232, USB, LAN)
-

AC/DC INPUT Terminal

When Load Input Connector is used, be sure that the rated specification of the voltage and current of the AEL-5000 Series AC/DC Electronic Load shall not be exceeded.

typical connection of AEL-5000 Series load module

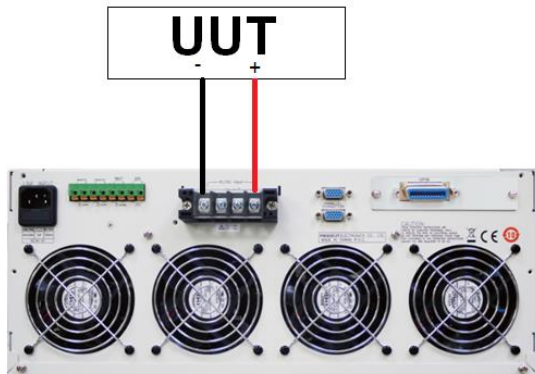

V-sense input terminal

In order to solve the voltage drop of the conductor under the condition of big load current, Vsense-CLIP cable can be used to connect with the specific point to be measured thus obtaining the specific voltage value.

typical connection of AEL-5000 Series load module

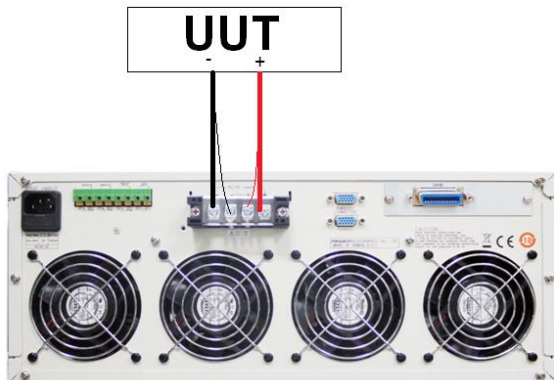

I-monitor (CT isolated)

The I-monitor is provided as a socket. It is designed to enable the user to monitor the Electronic Load's input current or short current. The I-monitor's signal is 0V to 10V. This signal is proportional to the full scale current that the particular electronic load is capable of.

Example

AEL-5008-350-75: $I_{max} = 75A$ therefore $I\text{-monitor } 10V = 75A$ so $1V = 7.5A$

	Please refer to the specification paragraph for the maximum current that each AEL-5000 series load is capable of.
V-monitor (IC isolated)	V-monitor output signal is mainly designed connection to the oscilloscope, observe UUT Voltage waveform, The V-monitor's signal is 0V to 10V. Please refer to page 259, this signal is proportional to the full scale current that the particular electronic load.
Analog programming input	<p>The Electronic Load has an analog programming input on the rear panel of the mainframe. The analogue programming input enables the load module to track and load according to an external 0-10V signal.</p> <p>The analog programming input is configured as a terminal on the mainframe's rear panel.</p> <p>The AEL-5000 series Load will attempt to load proportionally according to the signal and the load module's maximum current or power range.</p> <p>For example: AEL-5008-350-75: $I_{max} = 75A$ and $P_{max} = 7500W$</p> <p>So in CC mode if analogue programming input is 5V = 37.5A load setting or in CP mode if analogue programming input is 1V = 750W load setting</p> <p>In the Constant Current mode, 0V to 10V analog input signal can be set to 0A to full scale of the load current to AEL-5008-350-75, 10V analog input signal can produce 75A load current.</p> <p>In the Constant power mode, 0V to 10V analog input signal can be set to 0W to full scale of the load power to AEL-5008-350-75, 10V analog input signal can produce 7500W load Power.</p>



Note

The above operation must be LOAD ON

Master/Slave Description

Background

AEL-5000 Series “MASTER / SLAVE” Parallel function, 1 Master, 7 SLAVE, setting method press the System key to set the CONTROL MODE to select ALONE, MASTER or SLAVE1 ~ 7, Press the ENTER key to set, when Power off Data will not be lost, this parameter is saved. Master will automatically detect whether there is slave machine, if there is no Slave Machine will run “ALONE Mode”, if the Slave machine will run “MASTER Mode”.

Master machine measuring current and power meter is to show the total current and total power (Master + Slave), the voltage meter is displayed by the Master Machine, the Slave machine voltage meter position will display “SL1” ~ “SL7”.



Note

- Master/Slave operation in parallel cannot be performed on different models.
 - When Master / Slave is operated in parallel, the left and right keys are invalid.
 - Master/Slave operation in parallel, When Limit is set OPL or OCL functions, Slave will not display the setting value.
-

- CTRL ALONE
- CTRL MASTE 3PH
- CTRL MASTE BOOST
- CTRL SLAVE 1
- CTRL SLAVE 2
- CTRL SLAVE 3
- CTRL SLAVE 4
- CTRL SLAVE 5
- CTRL SLAVE 6

- CTRL SLAVE 7

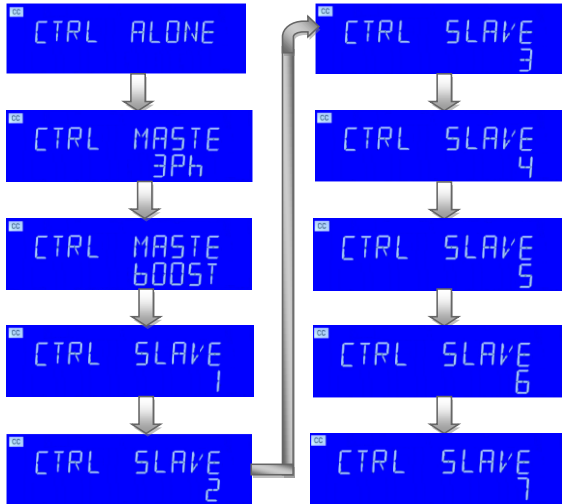

2 operating modes for Master/Slave

Boost mode

Boost mode is for master / slave parallel application, the setting current will be actively shared to each load, Master ammeter will show the total current that is the sum of all ammeters, Slave voltmeter will show SL1 ~ SL2, the others are unchanged.



- The following procedure should be followed before applying power on Master/Slave mains:
Step1. Turn on (O) the Slave POWER switch.
Step2. Turn on (O) the Master POWER switch.
- The following procedure should be followed before applying power off
Master/Slave mains:
Step1. Turn off (I) the Master POWER switch.
Step2. Turn off (I) the Slave POWER switch.

Parallel method

Use HD-DSUB 15pin 1: 1 Cable to connect the MASTER and SLAVE rear panel, HD-DSUB 15pin connector (connect the upper and lower Connectors)



Caution

Do not use VGA Cable, because of internal pin4 ~ 8, 11 and chassis short circuit.

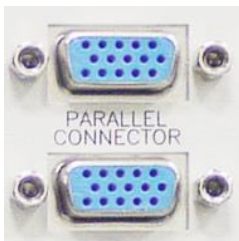

3PH mode

3PH mode is for 3 phase application, three AEL-5000 series can be connected for three phase Δ or Y connection, the setting current value (single-phase current value) will be sent to each Slave unit automatically, the user does not have to set each unit.



Master 3phase Manual operation (AEL-5008-350-75 MASTER 3ph/SLAVE model the following is example)

PRESET setting: CC/LIN/CR/CV/CP Mode as Figure, CC setting 60A= Master 60A + Slave 1 60A+ Slave 2 60A, LIN setting 60A=Master 60A + Slave 1 60A+ Slave 2 60A, CR:

1.8333 Ω =Master=Slave
1=1.8333 Ω =Slave2=1.8333 Ω ,

CP: 6600W=Master 6600W = Slave 1 6600W=Slave 2 6600W.

CV: 110V=Master 110V= Slave 1=110V =Slave 2=110V.

CC is set to 60A Master 3phase Display



	Slave 1 Display	
	Slave 2 Display	
LIN is set to 60A	Master 3phase Display	
	Slave 1 Display	
	Slave 2 Display	
CR is set to 1.8333Ω	Master 3phase Display	
	Slave 1 Display	
	Slave 2 Display	
CP is set to 6600W	Master 3phase Display	
	Slave 1 Display	

	Slave 2 Display	
CV is set to 110V	Master 3phase Display	
	Slave 1 Display	
	Slave 2 Display	









Master boost Manual operation (AEL-5008-350-75 MASTER boost/SLAVE model the following is example)

PRESET Setting: CC/LIN/CR/CV/CP Mode as Figure, CC setting 180A=Master 180A + Slave 1 60A+ Slave 2 60A, LIN setting 180A= Master 180A + Slave 1 60A+ Slave2 60A,

CR: 800Ω = Master// Slave1// Slave2 = 800Ω // 2400Ω // 2400

CP: 22500W = Master 22500W+Slave 1 7500W + Slave 2 7500W.

CC is set to 180A	Master booster Display	
	Slave 1 Display	
	Slave 2 Display	

LIN is set to 180A	Master booster Display	
	Slave 1 Display	
	Slave 2 Display	
CR is set to 2400Ω	Master booster Display	
	Slave 1 Display	
	Slave 2 Display	
CP is set to 22500W	Master booster Display	
	Slave 1 Display	
	Slave 2 Display	



Note

Master Mode operation except CC /LIN / CR / CV / CP MODE, The following functions will be disabled.

- Recall/Store Disable.
- ALL test item functions disable. (That will be enable When master mode setting to 3PH)
- EXTIN Disable

REMOTE operating

Master mode can use the command as follows.

Setting preset numeric command	Remark
MODE{SP}{CC LIN CR CV CP}{; NL}	
OCL{SP}{NR2}{; NL}	
OPL{SP}{NR2}{; NL}	
SENS{SP}{ON OFF 1 0}{; NL}	0:OFF, 1:ON
ON:ANG{SP}{NR2}{; NL}	0~359
OFF:ANG{SP}{NR2}{; NL}	0~359
CC CURR:{A B}{SP}{NR2}{; NL}	
LIN:{A B}{SP}{NR2}{; NL}	
CR RES:{A B}{SP}{NR2}{; NL}	
CV VOLT: {A B}{SP}{NR2}{; NL}	
CVI:{A B}{SP}{NR2}{; NL}	
CP:{A B}{SP}{NR2}{; NL}	
MODE{SP}{CC LIN CR CP}{; NL}	
LEV{SP}{A B 0 1}{; NL}	
FREQ{SP}{AUTO NR2}{; NL}	0, 40~440Hz
PF{SP}{NR2}{; NL}	
CF{SP}{NR2}{; NL}	1.4~5.0; 1.3 (TRAIL), 1.2 (LEAD), 1.1 (LDNEG), 1.0 (LDPOS)
LOAD{SP}{ON OFF 1 0}{; NL}	
MEAS:CURR{?}{; NL}	+###.###
MEAS:VOLT{?}{; NL}	+###.###
MEAS:POW{?}{; NL}	+####.#
MEAS:VA{?}{; NL}	+####.#

MEAS:VAR{?}; NL}	#####.#
MEAS:PF{?}; NL}	####.##
MEAS:CF{?}; NL}	####.##
MEAS:FREQ{?}; NL}	#####.#
MEAS:V_THD{?}; NL}	####.##
MEAS:I_THD{?}; NL}	####.##
MEAS:V_HARM{?}; NL}	
MEAS:I_HARM{?}; NL}	
HARM{SP}{NR1}; NL}	1~50;select Harmonic step
SYNC{SP}{ON OFF}; NL}	
MEAS:TYPE{SP}{RMS PEAK MAX MIN}; NL}	
REMOTE; NL}	RS232/USB/LAN command
LOCAL; NL}	RS232/USB/LAN command

Auto sequence 3 phase mode can't be used command

Auto sequence set command	NOTE	RETURN
FILE{SP}{n}; NL}	n = 1~9	
FILE{?}{n}; NL}		1~9
STEP{SP}{n}; NL}	n = 1~32	
STEP{?}{n}; NL}		1~32
TOTSTEP{SP}{n}; NL}	Total step, n = 1~32	
TOTSTEP{?}{n}; NL}		1~32
SB{SP}{n}; NL}	LOAD State n=1~150	
SB{SP}{?}; NL}		1~150
TIME{SP}{NR2}; NL}	100~9999 (ms)	100~9999 (msec)
SAVE; NL}	Save "File n" data	
REPEAT{SP}{n}; NL}	n = 0~9999	
REPEAT{?}{n}; NL}		0~9999
RUN{SP}{F}{n}; NL}	n = 1~9	AUTO REPLY "PASS" or "FAIL:XX" (XX=NG STEP)
BEEP{SP}{ON OFF}; NL}	Set buzzer ON/OFF	

3PH Mode use the command: In addition 3PH Mode can use the “GLOB:” command in table below

Command	Return
	Master, Slave1, Slave2,
GLOB:MEAS:CURR{?}; NL}	+###.###,+###.###,+###.###,
GLOB:MEAS:VOLT{?}; NL}	+###.##,+###.##,+###.##,
GLOB:MEAS:POW{?}; NL}	+#####.#,+#####.#,+#####.#,
GLOB:MEAS:VAR{?}; NL}	+#####.#,+#####.#,+#####.#,
GLOB:MEAS:VA{?}; NL}	+#####.#,+#####.#,+#####.#,
GLOB:MEAS:V_THD{?}; NL}	+###.##,+###.##,+###.##,
GLOB:MEAS:I_THD{?}; NL}	+###.##,+###.##,+###.##,
GLOB:MEAS:V_HARM{?}; NL}	+###.##,+###.##,+###.##,
GLOB:MEAS:I_HARM{?}; NL}	+###.###,+###.###,+###.###,
GLOB:MEAS:PF{?}; NL}	+###.##,+###.##,+###.##,
GLOB:MEAS:CF{?}; NL}	+#####.#,+#####.#,+#####.#,
GLOB:MEAS:FREQ{?}; NL}	+#####.#,+#####.#,+#####.#,

INSTALLATION

Check line voltage.....	139
Grounding requirements.....	141
Power up	142
Connection to the load Input Terminal.....	143
Interface Card	144
GPIB & RS232 interface option	144
RS232 interface option.....	146
GPIB interface option	146
USB interface option.....	147
LAN interface option	147
I/O connection	148
Load wire inductance.....	149
Parallel and three-phase control	153
3 phase Y connection	153
3 phase Δ connection	153
Parallel connection.....	153

Check line voltage

Background	The AEL-5000 series high power AC/DC load can operation with 100 Vac ~240Vac input as indicated on the label on the rear panel. Make sure that the factory check mark corresponds to your nominal line voltage. Skip this procedure if the label is corrected marked.
Installation	<ol style="list-style-type: none">1. With the AEL-5000 series AC/DC load power OFF, disconnect the power cord.2. Refer the drawing on the rear panel of AEL-5000 Series high power load below.

Model	Fuse spec
AEL-5023-350-112.5 AEL-5023-425-112.5	T10A/250V(5*20mm)
AEL-5019-350-112.5 AEL-5019-425-112.5	T8A/250V(5*20mm)
AEL-5015-350-112.5 AEL-5015-425-112.5	T6A/250V(5*20mm)
AEL-5012-350-112.5 AEL-5012-425-112.5	T4A/250V(5*20mm)
AEL-5008-350-75 AEL-5008-425-75 AEL-5006-350-56 AEL-5006-425-56	T3A/250V(5*20mm)
AEL-5002-350-18.75 AEL-5002-450-18.75 AEL-5003-480-18.75 AEL-5003-350-28 AEL-5003-425-28 AEL-5004-480-28 AEL-5004-350-27.5 AEL-5004-425-37.5	T2A/250V(5*20mm)

Grounding requirements

- | | |
|--------------|--|
| Installation | <ol style="list-style-type: none">1. It is requested to use the 3Pin plug connector only for AEL-5000 series mainframe to out of danger when electric leakage. And the complete and proper grounded is necessary.2. The AEL-5000 series high power AC/DC load is equipped with three conductor cable which plugs in an appropriate receptacle to ground the instrument's cover. |
|--------------|--|
-

Power up

The following procedure should be followed before applying mains power:

- | | |
|-----------|--|
| Procedure | <ol style="list-style-type: none">1. Turn off (O) the POWER switch.2. Check that the power cord is corrected.3. Check that nothing is connected to the DC INPUT on the rear panels.4. Turn on POWER switch. |
|-----------|--|
-

Connection to the load Input Terminal

Connection procedure of the load input terminal on the rear panel

- | | |
|-----------|---|
| Procedure | <ol style="list-style-type: none">1. Turn off POWER switch.2. Check that the output of the equipment under test is off.3. Connect the load wire to the load input terminal on the rear panel.4. Check the polarity of the connection and connect the load wire to the output |
|-----------|---|



Note

Avoid equipment damaged, don't input the DC voltage standard output to the DC Load input terminal, if calibration voltage meter required, please input the DC voltage standard to the Vsense input.

Interface Card

GPIB & RS232 interface option

Connection procedure of the load input terminal on the rear panel

- | | |
|-----------|--|
| Procedure | <ol style="list-style-type: none">1. GPIB + RS232 interface is on the rear panel of AEL-5000 series Mainframe for application GPIB or RS232 .2. GPIB and RS232 interface can only be used at the same time, to Change the interface must reboot unit.3. GPIB connection with three important limitations as Described below:<ul style="list-style-type: none">• The maximum number of devices including the controller is no More than 15.• The maximum length of all cable is no more than 2 meters times The Number of devices connected together, up to 20 meters Maximum.4. RS232 Female Block connections on the back panel, the Connecting Device and the computer RS232 port to one-way Connection. |
|-----------|--|
-

The figure below shows the RS232 connector (Female) on the rear panel Connects AEL-5000 series Mainframe to RS232 port of computer in one By one Configuration .The RS232 BAUD-RATE can be set in the front Panel, it Will be lit the GPIB Address when press the "SYSTEM" button. Press it again, it will be lit the BAUD-RATE.

AEL-5000 series
GPIB & RS232
interface



RS232 interface option

Connection procedure of the load input terminal on the rear panel

The figure below shows the RS232 connector (Female) on the rear panel connects AEL-5000 series mainframe to RS232 port of computer in one by one configuration. The RS232 BAUD-RATE can be set in the front panel, it will be lit the GPIB address when press the "SYSTEM" button. Press it again, it will be lit the BAUD-RATE.

AEL-5000 series
RS232 interface



GPIB interface option

Connection procedure of the load input terminal on the rear panel

The maximum number of devices including the controller is no more than 15.

The maximum length of all cable is no more than 2 meters times the Number of devices connected together, up to 20 meters maximum.

AEL-5000 series
GPIB interface



USB interface option

Connection procedure of the load input terminal on the rear panel

The figure below shows the USB connector in the rear panel of AEL-5000 series mainframe.

AEL-5000 series
USB interface



Note

Please refer Appendix on page 287 for details about USB instruction.

LAN interface option

Connection procedure of the load input terminal on the rear panel

The figure below shows the LAN connector in the rear panel of AEL-5000 series mainframe.

AEL-5000 series
LAN interface



Note

Please refer Appendix on page 293 for details about LAN instruction.

I/O connection

Connection procedure of the load input terminal on the rear panel

AEL-5000 series I/O Interface with I monitor, V-monitor, Analog Programming Input, SYNC input

AEL-5000 series
I/O Connection

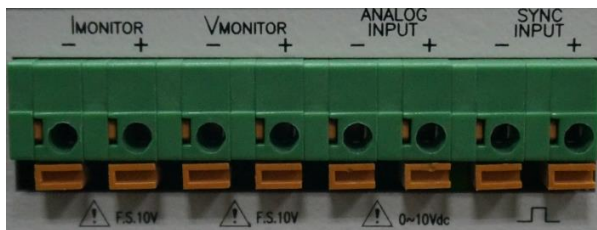

Load wire inductance

Connection procedure of the load input terminal on the rear panel

The load wiring has an inductance (L). When the current (I) varies in short time period, It generates a large voltage at both ends of the wiring cable. This voltage applies to all of the load input terminals of the AEL-5000 series when the impedance of the EUT is relatively small. The voltage generated by the load wire inductance (L) and the current variation (I) is expressed using the following equation.

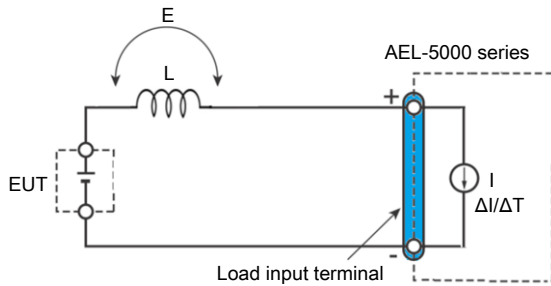

$$E = L \times (\Delta I / \Delta T)$$

E: Voltage generated by the wire inductance

L: Load wire inductance

ΔI : Amount of Current variation

ΔT : Variation period of current

In general, the wire inductance can be measured approximately $1 \mu\text{H}$ per 1 meter. If the 10 meters of Load wires is connected between the EUT and the electronic load (AEL-5000 series) with the current Variation of $2 \text{ A}/\mu\text{s}$, the voltage generated by the wire inductance Will be 20 V.

The negative polarity of the load input terminal is the reference potential of the external Control signal, Therefore, the device connected to the external control terminal may get malfunctioned.

When operating under the constant voltage (CV) mode or constant resistance (CR) mode or constant power (CP), the load current is varied by the voltage at the load input terminal, so the operation can be affected easily by the generated voltage.

The wiring to the EUT should be twisted and the shortest as possible.

If the load wire is long or has a large loop, the wire inductance is increased. Consequently, the Current variation that results when switching occurs will cause a large voltage drop.

When the value of instantaneous voltage drops under the minimum operating voltage depends on the generated voltage at the load input terminal, the response of recovery will be extensively delayed.

In such event, the electronic load (AEL-5008-350-75) may generate unstable oscillation. In such condition, the input voltage may exceed the maximum input voltage and Cause damage to the AEL-5000 series.

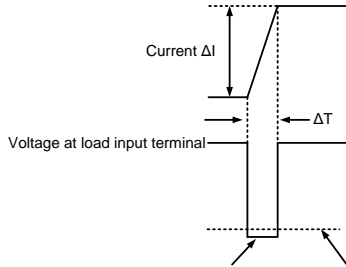

When the voltage drops under minimum operating voltage, the electronic load may generate unstable oscillation.

Waveform example:
Generate unstable oscillation

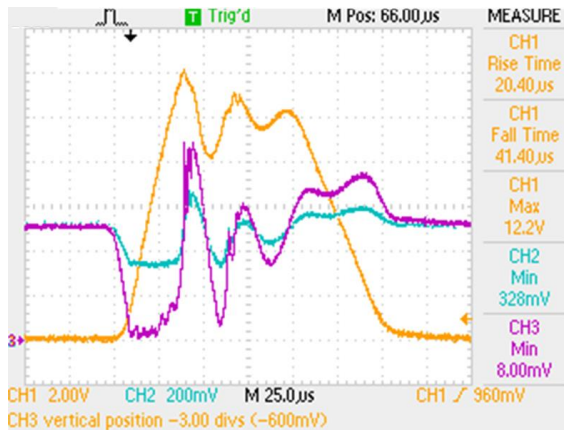

CH1= Imonitor

CH2=Power Supply output Voltage (x10)

CH3= LOAD Input Voltage (x10)

You must be careful especially when the bandwidth setting is high or switching is performed using large currents through parallel operation.

To prevent problems, connect the AEL-5000 series and the equipment under test using the shortest Twisted Wire possible to keep the voltage caused by inductance between the minimum operating Voltage and the maximum input voltage range or set a low bandwidth.

If the high-speed response operation is not required, decrease the bandwidth setting.

In such settings, the value of DI / DT will be decreased, accordingly the generated voltage Will be reduced even the inductance of load wiring can't be reduced.

In the case of DC operation also, the phase delay of the current may cause instability in the AEL-5000 series Control inducing oscillation. In this case also, connect the AEL-5000 series and the equipment under test using the shortest twisted wire possible.

If only DC operation is required, a capacitor may be connected to the load Input Terminal as shown in Fig below to alleviate oscillation. In this case, use the capacitor within its Allowable ripple current.

Length of wiring

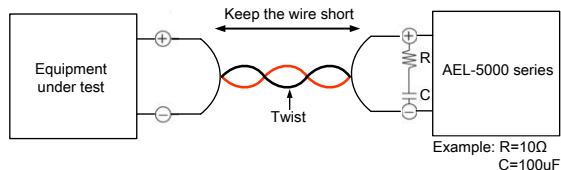

Parallel and three-phase control

3 phase Y connection

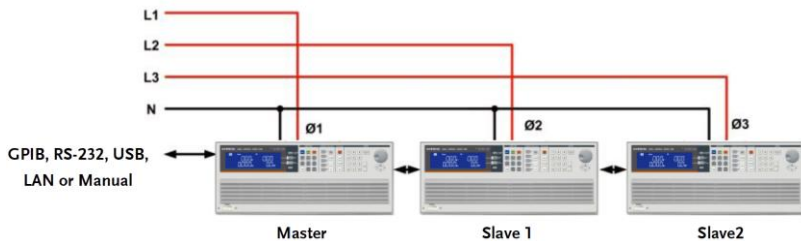

3 phase Δ connection

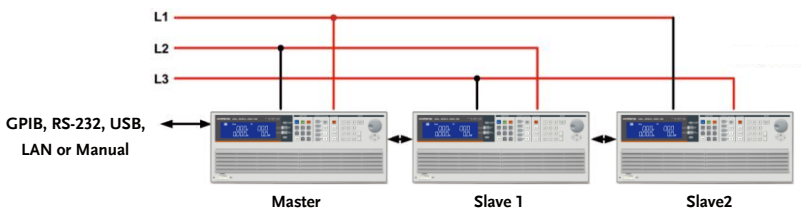

Parallel connection

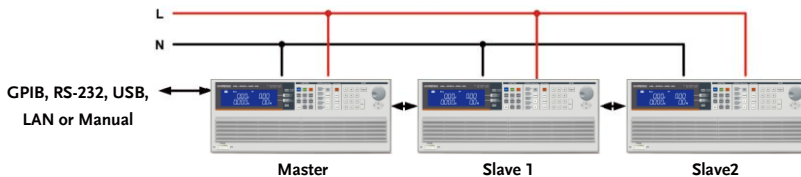

REMOTE CONTROL

The rear panel remote control interface of AEL-5000 series mainframe is designed to connect PC or NOTEBOOK PC with remote control interface, the NOTEBOOK PC acts as a remote controller of AEL-5000 series Electronic Load.

This feature can be used as an automatic load/cross load regulation and centering voltage testing for a switching power supply or an rechargeable battery charge/discharge characteristic testing. The function capability of rear panel remote control interface not only can set the load level and load status, but also can read back the load voltage and load current.



Note

When use USB/LAN interface controls the AEL-5000 series, the AEL-5000 series will convert the USB/LAN interface to RS232 interface

Interface Configuration	156
Configure RS232C	156
Communication Interface programming command list.....	158
SIMPLE TYPE FORMAT	158
System command.....	163
Measure command	163
AUTO SEQUENCE.....	164
COMPLEX TYPE FORMAT	165
Command Syntax	171
The description of abbreviation	171
Communication Interface programming command syntax description	171
Command List	173
PRESET Commands	176
Limit Commands	194

STATE commands	196
System Commands	203
Measure Commands	206

Interface Configuration

Configure RS232C

The following RS232 commands are same as GPIB commands. The RS232 protocol in AEL-5000 series mainframe is listing below:

RS232C Configuration	Baud Rate	9600~115200bps
	Stop Bit	1 bit
	Data Bit	8 bits
	Parity	None
	Handshaking	Hardware (RTS/CTS)

The RS232 Interface connector of AEL-5000 series rear panel

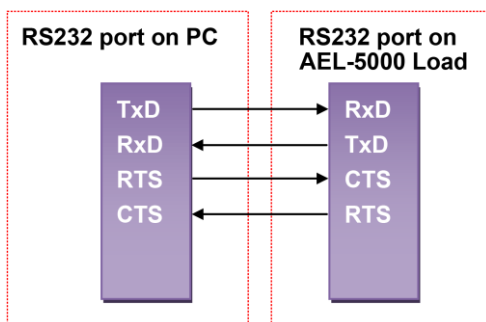

Inside of AEL-5000 series Mainframe

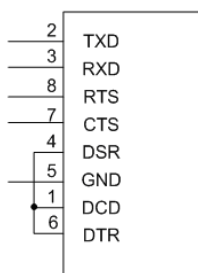

Pin Assignment

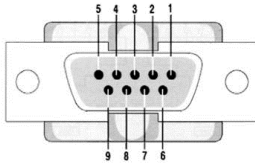

Table PC RS232 port

PIN	Abbreviation	Description
Pin1	CD	Carrier Detect
Pin2	RXD	Receive
Pin3	TXD	Transmit
Pin4	DTR	Data Terminal Ready
Pin5	GND	Ground
Pin6	DSR	Data Set Ready
Pin7	RTS	Request To Send
Pin8	CTS	Clear To Send
Pin9	RI	Ring Indicator

Communication Interface programming command list

SIMPLE TYPE FORMAT

Table: Communication interface programming setting command summary

Setting preset numeric command	Note
HARM{SP}{NR1}{; NL}	HARMONICS 1~50
LIN:{A B}{SP}{NR2}{; NL}	
CC CURR:{A B}{SP}{NR2}{; NL}	
CP:{A B}{SP}{NR2}{; NL}	
CR RES:{A B}{SP}{NR2}{; NL}	
CV VOLT:{A B}{SP}{NR2}{; NL}	
CVI:{A B}{SP}{NR2}{; NL}	CV CURR
TCONFIG{SP}{NORMAL SHORT OPP OCP NLIN NLCR FUSE BATT TRANS INRUSH SURGE ITHD}{; NL}	
OCP:START{SP}{NR2}{; NL}	
OCP:STEP{SP}{NR2}{; NL}	
OCP:STOP{SP}{NR2}{; NL}	
VTH{SP}{NR2}{; NL}	
OPP:START{SP}{NR2}{; NL}	
OPP:STEP{SP}{NR2}{; NL}	
OPP:STOP{SP}{NR2}{; NL}	
STIME{SP}{NR2}{; NL}	
PF{SP}{+ -}{NR2}{; NL}	Power factor
CF{SP}{NR2}{; NL}	Crest factor
BATT:MODE{SP}{CC LIN CV CP}{; NL}	
BATT:TIME{SP}{NR1}{; NL}	
EXTIN{SP}{ON OFF}{; NL}	
TURBO{SP}{ON OFF}{; NL}	
AVG{SP}{NR2}{; NL}	NR2:1 2 4 8 16
CPRSP{SP}{NR2}{; NL}{; NL}	NR2:0~7
CYCLE{SP}{NR2}{; NL}	NR2:1~16

ON:ANG{SP}{NR2}{; NL}	0~359
OFF:ANG{SP}{NR2}{; NL}	0~359
BW{SP}{NR2}{; NL}	
FREQ{SP}{AUTO NR2}{; NL}	0.40~440Hz
ITIME{SP}{NR2}{; NL}	0.1ms~100.0ms
ISTART{SP}{NR2}{; NL}	
ISTEP{SP}{NR2}{; NL}	
ISTOP{SP}{NR2}{; NL}	
SURGE:Tn{SP}{NR2}{; NL}	
SURGE:Sn{SP}{NR2}{; NL}	
SNUB{SP}AUTO ON OFF{; NL}	
ITHD:PCT{SP}{NR2}{; NL}	
ITHD:CC{SP}{NR2}{; NL}	
IMODE{SP}{CC CR 0 1}{; NL}	
RSTART{SP}{NR2}{; NL}	
RSTEP{SP}{NR2}{; NL}	
RSTOP{SP}{NR2}{; NL}	
IPEAK{SP}{NR2}{; NL}	
ICYCLE{SP}{NR2}{; NL}	
FUSE:TIME _n {SP}{NR2}{; NL}	
FUSE:CYCLE{SP}{NR2}{; NL}	
FUSE:CC _n {SP}{NR2}{; NL}	
FUSE:STEP{SP}{NR2}{; NL}	
FUSE:OFFTIME{SP}{NR2}{; NL}	
FUSE:TYPE{SP}{TRIP NTRIP}{; NL}	
BATT:FREQ{SP}{AC DC}{; NL}	

Table: Communication Interface programming query command summary

Query preset numeric command	Return
HARM{?}{NR2}{; NL}	##
LIN:{A B}{?}{; NL}	+###.###
CC CURR:{A B}{?}{; NL}	+###.###
CP:{A B}{?}{; NL}	+#####.#
CR RES{A B}{?}{; NL}	+#####.#####
CV VOLT:{A B}{?}{; NL}	+###.##
CVI{?}{; NL}	+###.###

TCONFIG{?}; NL}	1:NORMAL 7:FUSE 2:SHORT 8:BATT 3:OPP 9:Trans 4:OCP 10:INRUSH 5: non-LIN 11:SURGE 6: nocLIN+CR
OCP:START{?}; NL}	+###.###
OCP:STEP{?}; NL}	+###.###
OCP:STOP{?}; NL}	+###.###
VTH {?}; NL}	+###.##
OPP:START{?}; NL}	+#####.#
OPP:STEP{?}; NL}	+#####.#
OPP:STOP{?}; NL}	+#####.#
STIME{?}; NL}	+#####
PF{?}; NL}	+###.##
CF{?}{NR2}; NL}	+#####.#
OCP{?}; NL}	+###.###
OPP{?}; NL}	+#####.#
BATT:MODE{?}; NL}	0~3=CC/LIN/CR/CP
BATT:TIME{?}; NL}	+#####
DISC:TIME{?}; NL}	
DISC:AH{?}; NL}	
EXTIN{?}; NL}	0~1
TURBO{?}; NL}	0~1
TRIP:TIME{?}; NL}	+#####.#
TRANS:TIME{?}; NL}	+###.##
AVG{?}; NL}	1 2 4 8 16
CPRSP{?}; NL}	0~7
CYCLE{?}; NL}	1~16
ON:ANG{?}; NL}	+#####
OFF:ANG{?}; NL}	+#####
REP:COUNT{?}; NL}	+#####
BW{?}; NL}	1~15
FREQ{?}; NL}	+###.##
ITIME{?}; NL}	+#####.#
ISTART{?}; NL}	+###.###
ISTEP{?}; NL}	+###.###
ISTOP{?}; NL}	+###.###

SURGE:Tn{?}; NL}	+###.##
SURGE:Sn{?}; NL}	+###.###
SNUB{?}; NL}	0: OFF, 1: ON
ITHD:PCT{?}; NL}	+#####
ITHD:CC{?}; NL}	+##.###
IMODE{?}; NL}	0: CC, 1: CR
RSTART{?}; NL}	+#####.#
RSTEP{?}; NL}	+#####.#
RSTOP{?}; NL}	+#####.#
IPEAK{?}; NL}	+###.##
ICYCLE{?}; NL}	+#####.#
FUSE:TIME{n}{?}; NL}	+###.##
FUSE:CYCLE{?}; NL}	+#####
FUSE:CCn{?}; NL}	+##.###
FUSE:STEP{?}; NL}	1~3
FUSE:OFFTIME{?}; NL}	+#####.#
FUSE:TYPE{?}; NL}	0: TRIP, 1: NTRIP
BATT:FREQ{?}; NL}	0: DC,1: AC

Table: Communication Interface programming limit command summary

Limit command	Return
IH IL{SP}{NR2}; NL}	
IH IL{?}; NL}	+##.###
WH WL{SP}{NR2}; NL}	
WH WL{?}; NL}	+#####.#
VH VL{SP}{NR2}; NL}	
VH VL{?}; NL}	+#####.#
SVH SVL{SP}{NR2}; NL}	
SVH SVL{?}; NL}	+###.##
VAH VAL{SP}{NR2}; NL}	
VAH VAL{?}; NL}	+#####.#
OPL OCL{SP}{NR2}; NL}	Over power limit/Over current limit
OPL OCL{?}; NL}	+#####.#/+##.###

Table: State command summary

State command	Remark
LOAD{SP}{ON OFF 1 0} {; NL}	
LOAD{?}{; NL}	0:OFF 1:ON
MODE{SP}{CC LIN CR CV CP}{; NL}	
MODE{?}{; NL}	0 1 2 3 4:CC LIN CR CV CP
PRES{SP}{ON OFF 1 0}{; NL}	
PRES{?}{; NL}	0:OFF 1:ON
SENS{SP}{ON OFF AUTO 1 0}{; NL}	
SENS{?}{; NL}	0:OFF/AUTO 1:ON
LEV{SP}{ LOW HIGH 0 1} {; NL}	
LEV{?}{; NL}	0:LOW/A 1:HIGH/B
CLR{; NL}	
CLR:METER{ ; NL}	
ERR{?}{; NL}	
NG{?}{; NL}	0:GO 1:NG
PROT{?}{; NL}	
NGENABLE{SP}{ON OFF}{; NL}	
START{; NL}	
STOP{; NL}	
TESTING{?}{; NL}	0:TEST END,1:TESTING
SYNC{SP}{ON OFF 1 0}{; NL}	
SYNC{?}{; NL}	0:OFF 1:ON

System command

Table: System command summary

Command	Note	Return
RECALL{SP}{m}{; NL}	m=1~150 , m:STATE	
STORE{SP}{m}{; NL}	m=1~150 m:STATE	
REMOTE{; NL}	RS232/USB/LAN command	
LOCAL{; NL}	RS232/USB/LAN command	
NAME{?}{; NL}		"XXXXX"
*RST{; NL}		
SN{?}{; NL}		

Measure command

Table: Measure command summary

Command	Return
MEAS:TYPE{SP} {RMS PEAK MAX MIN}{; NL}	
MEAS:CURR{?}{; NL}	+##.###
MEAS:VOLT{?}{; NL}	###.##
MEAS:POW{?}{; NL}	#####.#
MEAS:VAR{?}{; NL}	#####.#
MEAS:VA{?}{; NL}	#####.#
MEAS:V_THD{?}{; NL}	###.##
MEAS:I_THD{?}{; NL}	###.##
MEAS:V_HARM{?}{; NL}	###.##
MEAS:I_HARM{?}{; NL}	###.###
MEAS:VC{?}{; NL}	###.##, +##.###
Remark	<ol style="list-style-type: none"> 1. Current engineering unit: A/Arms 2. Resistance engineering unit: Ω 3. Voltage engineering unit: V/Vrms 4. Period engineering unit: mS 5. Frequency engineering unit: Hz. 6. Power engineering unit: W 7. Volt-Ampere engineering unit: VA

AUTO SEQUENCE

Table: Auto sequence command list

Auto sequence set command	Note	Return
FILE{SP}{n}{; NL}	n=1~9	
FILE{?}{; NL}		1~9
STEP{SP}{n}{; NL}	n=1~32	
STEP{?}{; NL}		1~32
TOTSTEP{SP}{n}{; NL}	Total step n=1~32	
TOTSTEP{?}{; NL}		1~32
SB{SP}{n}{; NL}	LOAD State n=1~150	
SB{?}{; NL}		1~150
TIME{SP}{NR2}{; NL}	100~9999(ms)	100~9999(msec)
SAVE{; NL}	Save "File n" data	
REPEAT{SP}{n}{; NL}	n=0~9999	
REPEAT{?}{; NL}		0~9999
RUN{SP}{F}{n}{; NL}	n=1~9	Auto reply "PASS" or "FAIL:XX" (XX = NG STEP)
BEEP{SP}{ON OFF}{; NL}	Set buzzer ON/OFF	

COMPLEX TYPE FORMAT

Table: Communication Interface programming setting command summary

Setting command summary	Remark
[PRESet:]HARMonics{SP}{NR1}{; NL}	
[PRESet:]LIN:A B{SP}{NR2}{; NL}	
[PRESet:]CC CURR:{A B}{SP}{NR2}{; NL}	
[PRESet:]CP:{A B}{SP}{NR2}{; NL}	
[PRESet:]CR RES:{A B}{SP}{NR2}{; NL}	
[PRESet:]CV VOLT:{A B}{SP}{NR2}{; NL}	
[PRESet:]CVI:{A B}{SP}{NR2}{; NL}	
[PRESet:]TCONFIG{SP}{NORMAL SHORT OPP OCP NLIN NLCR FUSE BATT TRANS INRUSH SURGE ITHD}{; NL}	
[PRESet:]OCP:START{SP}{NR2}{; NL}	
[PRESet:]OCP:STEP{SP}{NR2}{; NL}	
[PRESet:]OCP:STOP{SP}{NR2}{; NL}	
[PRESet:]VTH{SP}{NR2}{; NL}	
[PRESet:]OPP:START{SP}{NR2}{; NL}	
[PRESet:]OPP:STEP{SP}{NR2}{; NL}	
[PRESet:]OPP:STOP{SP}{NR2}{; NL}	
[PRESet:]STIME{SP}{NR2}{; NL}	
[PRESet:]PF{SP}{+ -}{NR2}{; NL}	Power factor
[PRESet:]CF{SP}{NR2}{; NL}	Crest factor
[PRESet:]BATT:MODE{SP}{CC LIN CV CP}{; NL}	
[PRESet:]BATT:TIME{SP}{NR1}{; NL}	
[PRESet:]EXTIN{SP}{ON OFF}{; NL}	
[PRESet:]TURBO{SP}{ON OFF}{; NL}	
[PRESet:]AVG{SP}{NR2}{; NL}	NR2:1 2 4 8 16
[PRESet:]CPRSP{SP}{NR2}{; NL}	NR2:0~7
[PRESet:]CYCLE{SP}{NR2}{; NL}	NR2:1~16
[PRESet:]ON:ANG{SP}{NR2}{; NL}	0~359
[PRESet:]OFF:ANG{SP}{NR2}{; NL}	0~359
[PRESet:]BW{SP}{NR2}{; NL}	
[PRESet:]FREQ{SP}{AUTO NR2}{; NL}	0, 40~440Hz

[PRESet:]ITIME{SP}{NR2}{; NL}	0.1ms~100.0ms
[PRESet:]ISTART{SP}{NR2}{; NL}	
[PRESet:]ISTEP{SP}{NR2}{; NL}	
[PRESet:]ISTOP{SP}{NR2}{; NL}	
[PRESet:]SURGE:Tn{SP}{NR2}{; NL}	
[PRESet:]SURGE:Sn{SP}{NR2}{; NL}	
[PRESet:]SNUB{SP}AUTO ON OFF{; NL}	
[PRESet:]ITHD:PCT{SP}{NR2}{; NL}	
[PRESet:]ITHD:PCT{SP}{NR2}{; NL}	
[PRESet:]ITHD:CC{SP}{NR2}{; NL}	
[PRESet:]IMODE{SP}{CC CR 0 1}{; NL}	
[PRESet:]RSTART{SP}{NR2}{; NL}	
[PRESet:]RSTEP{SP}{NR2}{; NL}	
[PRESet:]RSTOP{SP}{NR2}{; NL}	
[PRESet:]IPEAK{SP}{NR2}{; NL}	
[PRESet:]ICYCLE{SP}{NR2}{; NL}	
[PRESet:]FUSE:TIME _n {SP}{NR2}{; NL}	
[PRESet:]FUSE:CYCLE{SP}{NR2}{; NL}	
[PRESet:]FUSE:CC _n {SP}{NR2}{; NL}	
[PRESet:]FUSE:STEP{SP}{NR2}{; NL}	
[PRESet:]FUSE:OFFTIME{SP}{NR2}{; NL}	
[PRESet:]FUSE:TYPE{SP}{TRIP NTRIP}{; NL}	
[PRESet:]BATT:FREQ{SP}{AC DC}{; NL}	

Table: Communication Interface programming query command summary

Query command summary	Return
[PRESet:]HARMonics{?}{; NL}	##
[PRESet:]LIN:{A B}{?}{; NL}	+##.###
[PRESet:]CC CURR:{A B}{?}{; NL}	+##.###
[PRESet:]CP:{A B}{?}{; NL}	+####.#
[PRESet:]CR RES:{A B}{?}{; NL}	+#####.+#####
[PRESet:]CV VOLT:{A B}{?}{; NL}	+###.##

	1:NORMAL	7:FUSE
	2:SHORT	8:BATT
[PRESet:] TCONFIG {?}; NL	3:OPP	9:Trans
	4:OCP	10:INRUSH
	5: non-LIN	11:SURGE
	6: nocLIN+CR	
[PRESet:]OCP: START {?}; NL	+###.###	
[PRESet:]OCP: STEP {?}; NL	+###.###	
[PRESet:]OCP: STOP {?}; NL	+###.###	
[PRESet:]VTH{?}; NL	+###.##	
[PRESet:]OPP:START{?}; NL	+####.#	
[PRESet:]OPP:STEP{?}; NL	+####.#	
[PRESet:]OPP:STOP{?}; NL	+####.#	
[PRESet:]STIME{?}; NL	+#####	
[PRESet:]PF{?}; NL	+###.##	
[PRESet:]CF{?}; NL	+####.#	
[PRESet:]OCP{?}; NL	+###.###	
[PRESet:]OPP{?}; NL	+#####.#	
[PRESet:]BATT MODE{?}; NL		
[PRESet:]BATT TIME{?}; NL	+#####	
[PRESet:]DISC:TIME{?}; NL	+#####	
[PRESet:]DISC:AH{?}; NL	+#.#####	
[PRESet:]EXTIN{?}; NL	EXTIN OFF: 0, EXTIN ON: 1	
[PRESet:]TURBO{?}; NL	TURBO OFF: 0, TURBO ON: 1	
[PRESet:]TRIP:TIME{?}; NL	+###.##	
[PRESet:]TRANS:TIME{?}; NL	+###.##	
[PRESet:]AVG{?}; NL	1 2 4 8 16	
[PRESet:]CPRSP{?}; NL	0~7	
[PRESet:]CYCLE{?}; NL	1~16	
[PRESet:]ON:ANG{?}; NL	+#####	
[PRESet:]OFF:ANG{?}; NL	+#####	
[PRESet:]REP:COUNT{?}; NL	+#####	
[PRESet:]BW{?}; NL	1~15	
[PRESet:]FREQ{?}; NL	+###.#	
[PRESet:]ITIME{?}; NL	+####.#	
[PRESet:]ISTART{?}; NL	+###.###	
[PRESet:]ISTEP{?}; NL	+###.###	

[PRESet:]ISTOP{?}; NL}	+##.###
[PRESet:]SURGE:Tn{?}; NL}	###.##
[PRESet:]SURGE:Sn{?}; NL}	+##.###
[PRESet:]SNUB{?}; NL}	SNUB OFF:0, SNUB ON: 1
[PRESet:]ITHD:PCT{?}; NL}	+#####
[PRESet:]ITHD:CC{?}; NL}	+##.###
[PRESet:]IMODE{?}; NL}	0: CC, 1: CR
[PRESet:]RSTART{?}; NL}	+#####
[PRESet:]RSTEP{?}; NL}	+#####
[PRESet:]RSTOP{?}; NL}	+#####
[PRESet:]IPEAK{?}; NL}	+###.##
[PRESet:]FUSE:TIME{n}{?}; NL}	+###.##
[PRESet:]FUSE:CYCLE{?}; NL}	+#####
[PRESet:]FUSE:CCn{?}; NL}	+##.###
[PRESet:]FUSE:STEP{?}; NL}	1~3
[PRESet:]FUSE:OFFTIME{?}; NL}	+#####
[PRESet:]FUSE:TYPE{?}; NL}	0: TRIP, 1: NTRIP
[PRESet:]BATT:FREQ{?}; NL}	0: DC, 1: AC

Table: Communication Interface programming limit command summary

Limit	Return
LIMit:CURRent:{HIGH LOW}{SP}{NR2}{; NL}	
LIMit:CURRent:{HIGH LOW}{?}; NL}	+##.###
IH IL{SP}{NR2}{; NL}	
IH IL{?}; NL}	+##.###
LIMit:POWer:{HIGH LOW}{SP}{NR2}{; NL}	
LIMit:POWer:{HIGH LOW}{?}; NL}	+#####
WH WL{SP}{NR2}{; NL}	
WH WL{?}; NL}	+#####
LIMit:VOLTag:e:{HIGH LOW}{SP}{NR2}{; NL}	
LIMit:VOLTag:e:{HIGH LOW}{?}; NL}	+###.##
VH VL{SP}{NR2}{; NL}	
VH VL {?}; NL}	+###.##
SVH SVL{SP}{NR2}{; NL}	
SVH SVL{?}; NL}	+###.##
VAH VAL{SP}{NR2}{; NL}	

VAH VAL{?}; NL}	+####.#
OPL OCL{SP}{NR2}; NL}	Over power limit/Over current limit
OPL OCL {?}; NL}	+####.# / +##.###

Table: State command summary

State command	Remark
[STATe:]LOAD{SP}{ON OFF}; NL}	
[STATe:]LOAD{?}; NL}	0:OFF 1:ON
[STATe:]MODE{SP}{CC LIN CR CV CP}; NL}	
[STATe:]MODE{?}; NL}	0 1 2 3 4:CC LIN CR CV CP
[STATe:]SHORT{SP}{ON OFF}; NL}	
[STATe:]SHORT{?}; NL}	0:OFF 1:ON
[STATe:]PRESet{SP}{ON OFF}; NL}	
[STATe:]PRESet{?}; NL}	0:OFF 1:ON
[STATe:]SENSe{SP}{ON OFF AUTO }; NL}	
[STATe:]SENSe{?}; NL}	0:OFF 1:ON
[STATe:]LEVEl{SP}{A B}; NL}	
[STATe:]LEVEl{?}; NL}	0:A 1:B
[STATe:]LEV{SP}{A B}; NL}	
[STATe:]LEV{?}; NL}	0:A 1:B
[STATe:]CLRerr; NL}	
[STATe:]CLR:METER{ ; NL}	
[STATe:]ERRor{?}; NL}	
[STATe:]NO{SP}GOOD{?}; NL}	0:GO 1:NG
[STATe:]NG{?}; NL}	0:GO 1:NG
[STATe:]PROTect{?}; NL}	
[STATe:]NGENABLE{SP}{ON OFF}; NL}	
[STATe:]START; NL}	
[STATe:]STOP; NL}	
[STATe:]TESTING{?}; NL}	0:TEST END,1:TESTING
[STATe:]SYNCronize{SP}{ON OFF}; NL}	
[STATe:]SYNCronize{?}; NL}	0:OFF 1:ON

Table: System command summary

Command	Note	Return
[SYStem:]RECall{SP}{m}{;} NL	m=1~150	
[SYStem:]STORE{SP}{m}{;} NL	m=1~150	
[SYStem:]REMOTE{;} NL	RS232/USB/LAN command	
[SYStem:]LOCAL{;} NL	RS232/USB/LAN command	
[SYStem:]NAME{?}{;} NL		"XXXXXX"
[SYStem:]*RST{;} NL		
[SYStem:]SN{?}{;} NL		

Table: Measure command summary

Command	Return
MEASure:TYPE{SP}{RMS PEAK MAX MIN}{;} NL	
MEASure:CURRent{?}{;} NL	+##.###
MEASure:VOLTage{?}{;} NL	+###.##
MEASure:POW{?}{;} NL	+####.#
MEASure:VAR{?}{;} NL	+####.#
MEASure:VA{?}{;} NL	+####.#
MEASure:V_THD{?}{;} NL	+###.##
MEASure:I_THD{?}{;} NL	+###.##
MEASure:V_HARM{?}{;} NL	+###.##
MEASure:I_HARM{?}{;} NL	+###.###
MEASure:VC{?}{;} NL	+###.##,+###.###
Remark	<ol style="list-style-type: none"> 1. Current engineering unit: A/Arms 2. Resistance engineering unit: Ω 3. Voltage engineering unit: V/Vrms 4. Period engineering unit: mS 5. Frequency engineering unit: Hz. 6. Power engineering unit: W 7. Volt-Ampere engineering unit: VA

Command Syntax

The description of abbreviation

Command Tree	SP: Space, the ASCII code is 20 Hexadecimal. ;:Semicolon, Program line terminator, the ASCII code is 0A Hexadecimal. NL:New line, Program line terminator, the ASCII code is 0A Hexadecimal. NR2:Digits with decimal point. It can be accepted in the range and format of ###.#####. For Example: 30.12345, 5.0 The description of GPIB programming command syntax.
--------------	---

Communication Interface programming command syntax description

{ }	The contents of the { } symbol must be used as a part or data of the GPIB command, it cannot be omitted.
[]	The contents of the [] symbol indicates the command can be used or not. It depends on the testing application.

This symbol means option. For example "LOW | HIGH" means it can only use LOW or HIGH as the command, it can choose only one as the setting command.

Terminator: You have to send the program line terminator character after send the GPIB command, the available command terminator characters which can be accepted in AEL-5000 series mainframe is listed in table below

LF
LF WITH EOI
CR · LF
CR · LF WITH EOI

Semicolon ";":The semicolon ";" is a back-up command, the semicolon allows you to combine command statement on one line to create command message.

Command List

PRESET Commands	176
HARM	176
LIN	176
ON:ANG	176
OFF:ANG	177
CC CURR:A B	177
CP:A B	177
CR RES:A B	178
CV VOLT:A B	178
CVI :A B	179
TCONFIG	179
ITIME	180
ISTART	180
ISTEP	180
ISTOP	181
SURGE:T _n	181
SURGE:S _n	181
SNUB AUTO ON OFF	182
OCP:START	182
OCP:STEP	182
OCP:STOP	182
VTH	183
OPP:START	183
OPP:STEP	183
OPP:STOP	183
STIME	184
PF	184
CF	184
BATT:MODE	184
BATT:TIME	185
DISC:TIME	185
DISC:AH	185
EXTIN:ON/OFF	186
TURBO:{SP}{ON OFF}	186
TRIP:TIME	186
TRANS:TIME	186
AVG	187

CPRSP	187
CYCLE	188
BW	188
FREQ	188
REP:COUNT	189
ITHD:PCT	189
ITHD:CC	189
IMODE	189
RSTART	190
RSTEP	190
RSTOP	190
IPEAK	190
ICYCLE	191
FUSE:TIME _n	191
FUSE:CYCLE	191
FUSE:CC _n	192
FUSE:STEP	192
FUSE:OFFTIME	192
FUSE:TYPE	193
BATT:FREQ	193
Limit Commands	194
[LIMit:]CURRent: {HIGH LOW} or IH IL	194
[LIMit:]POWer: {HIGH LOW} or WH WL	194
[LIMit:]VOLtage: {HIGH LOW} or VH VL	195
SVH SVL	195
STATE commands	196
[STATe:]LOAD {SP} {ON OFF}	196
[STATe:]MODE {SP} {CC CR CV CP}	196
[STATe:]PRESet {SP} {ON OFF}	197
[STATe:]SENSe {SP} {ON OFF}	198
[STATe:]LEVel {SP} {A B} or LEV {SP} {A B}	198
[STATe:]CLRerr	199
[STATe:]CLR:Meter	199
[STATe:]ERRor	199
[STATe:]NG?	200
[STATe:]PROTect?	200
[STATe:]NGEABLE {ON OFF}	201
[STATe:]START	201
[STATe:]STOP	201
[STATe:]TESTING?	201

[STATe:]SYNCronize	202
System Commands	203
[SYStem:]RECall{SP} m {,n}	203
[SYStem:]STORe{SP} m {,n}	203
[SYStem:]NAME?	204
[SYStem:]REMOTE	204
[SYStem:]LOCAL	205
[SYStem:]*RST.....	205
[SYStem:]SN.....	205
Measure Commands	206
MEASure:CURRent?	206
MEASure:VOLTage?	206
MEASure:POWer?.....	206
MEASure:VAR?	206
MEASure:VA?	207
MEASure:V_THD?	207
MEASure:I_THD?.....	207
MEASure:V_HARM?.....	207
MEASure:I_HARM?	207
MEASure:VC	208
Auto Sequence Commands	209
FILE{SP} {n} {; NL}	209
STEP{SP} {n} {; NL}.....	209
TOTSTEP{SP} {n} {; NL}	209
SB{SP} {m,n} {; NL}	210
TIME{SP} {m,n} {; NL}	210
SAVE{; NL}	210
REPEAT{SP} {n} {; NL}	211
RUN{SP} {F} {n} {; NL}	211

PRESET Commands

Set and Read the Default of Load

Set →

→ Query

HARM

Description	Set and read the HARMONICS
Syntax	[PRESet:]HARM{SP}{NR1}{; NL}
Query Syntax	[PRESet:]HARM{?}{; NL}
Parameter	<NR1> HARMONICS 1~50 1~50

Set →

→ Query

LIN

Description	Set and read the linear current.
Syntax	[PRESet:]LIN:A B{SP}{NR2}{; NL}
Query Syntax	[PRESet:]LIN:A B{?}{; NL}

Set →

→ Query

ON:ANG

Description	Set and Read the loading angle control. The full range of 0-359 degree.
Syntax	[PRESet:]ON:ANG{SP}{NR2}{; NL}
Query Syntax	[PRESet:]ON:ANG{?}{; NL}
Parameter	<NR1> 0~359

OFF:ANG

Set →
→ Query

Description Set and Read the unloading angle control.
The full range of 0-359 degree.

Syntax [PRESet:]OFF:ANG{SP}{NR2}{;|NL}

Query Syntax [PRESet:]OFF:ANG{?}{;|NL}

Parameter <NR1>
0~359

CC|CURR:A|B

Set →
→ Query

Description Set and read the current of A or B.
This command is for setting the required Load current. And this command must be followed the next notices:
1. Level A load and Level B load current settings
2. are independent. The unit is A.

Syntax [PRESet:]CC|CURR:{A|B}{SP}{NR2}{;|NL}

Query Syntax [PRESet:]CC|CURR:{A|B}{?}{;|NL}

CP:A|B

Set →
→ Query

Description Set and read the value of Watt.
This command is for setting the required value of Watt, and the unit is W.

Syntax [PRESet:]CP:{A|B}{SP}{NR2}{;|NL}

Query Syntax [PRESet:]CP:{A|B}{?}{;|NL}

CR|RES:A|B

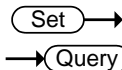

Description	<p>Set and read the value of Resistance.</p> <p>This command is used for setting the required value of Load Resistance. And this command must be followed the next notices:</p> <ol style="list-style-type: none"> 1. Level A load and Level B load resistance 2. settings are independent. The unit is Ω.
Synta	[PRESet:]CR RES:{A B}{SP}{NR2}{:} NL}
Query Syntax	[PRESet:]CR RES:{A B}{?}{:} NL}

CV|VOLT:A|B

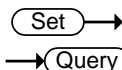

Description	<p>Set and read the value of voltage.</p> <p>This command is to set the voltage value of the electronic load. When issuing the command, NOTE to the following items:</p> <ol style="list-style-type: none"> 1. The Voltage setting values of group A load and group B load are independent. 2. The unit is Voltage (V).
Syntax	[PRESet:]CV:{A B}{SP}{NR2}{:} NL} [PRESet:]VOLT:{A B}{SP}{NR2}{:} NL}
Query Syntax	[PRESet:]CV:{A B}{?}{:} NL} [PRESet:]VOLT:{A B}{?}{:} NL}

CVI|:A|B

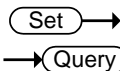

Description	<p>Set and read the initial current of the load constant voltage mode.</p> <p>This command is to set the current value of the electronic load. When issuing the command, NOTE to the following items:</p> <ol style="list-style-type: none"> 1. The current setting values of group A load and group B load are independent. 2. The unit is ampere (A).
Syntax	[PRESet:]CVI:{A B}{SP}{NR2}{: NL}
Query Syntax	[PRESet:]CVI:{A B}{?}{: NL}

TCONFIG

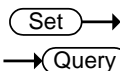

Description	<p>Set and read a test Item. There are nine options of this command. Those are NORMAL mode, OCP test, OPP test, SHORT, NLIN, NLCR, FUSE, BATT, TRANS, INRUSH, SURGE test, and ITHD.</p>
Syntax	[PRESet:]TCONFIG{NORMAL OCP OPP SHORT NLIN NLCR FUSE BATT TRANS INRUSH SURGE ITHD}{: NL}
Query Syntax	[PRESet:]TCONFIG?}{: NL}
Parameter	<NR2>
	1 NORMAL
	2 SHORT
	3 OPP
	4 OCP
	5 non-LIN
	6 nocLIN+CR
	7 FUSE

8	BATT
9	Trans
10	INRUSH
11	SURGE
12	ITHD

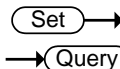

ITIME

Description	Set and read the INRUSH current time. Use this command to set the interval for current decrement. The setting range is 0.1ms~100.0ms.
Syntax	[PRESet:]TIME{SP}{NR2}{: NL}
Query Syntax	[PRESet:]ITIME?}{: NL}
Parameter	<NR2> 0.1ms~100.0ms

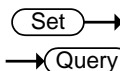

ISTART

Description	Set and read the starting current set point for the inrush current test. The starting current is set to twice the current specification.
Syntax	[PRESet:]ISTART{SP}{NR2}{: NL}
Query Syntax	[PRESet:]ISTART?}{: NL}

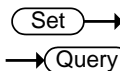

ISTEP

Description	Set and read the set value of the decrement current of the inrush current test. The step current is set to twice the current specification.
Syntax	[PRESet:]ISTEP{SP}{NR2}{: NL}
Query Syntax	[PRESet:]ISTEP?}{: NL}

		Set →
		→ Query
ISTOP		
Description	Set and read the set value of the minimum current for the inrush current test. Minimum current setting range current specification.	
Syntax	[PRESet:]ISTOP{SP}{NR2}{: NL}	
Query Syntax	[PRESet:]ISTOP{?}{: NL}	

		Set →
		→ Query
SURGE:Tn		
Description	Set and read the time setting for the surge current test. n: 1~3, the time to load current in three stages. When n=1, 2, the time setting range is 0.01~0.50 seconds. When n=3, the time setting range is 0.01~9.99 seconds or continuous loading.	
Syntax	[PRESet:]SURGE:Tn{SP}{NR2}{: NL}	
Query Syntax	[PRESet:]SURGE:Tn{?}{: NL}	

		Set →
		→ Query
SURGE:Sn		
Description	Set and read the load current value of the surge current test. n: 1~3, the load current in three stages. When n=1, 2, the load current setting range is twice the current specification. When n=3, the load current setting range is the current specification.	
Syntax	[PRESet:]SURGE:Sn{SP}{NR2}{: NL}	
Query Syntax	[PRESet:]SURGE:Sn{?}{: NL}	

Set →
 → Query

SNUB AUTO|ON|OFF

Description Set the SNUB AUTO/ON/OFF.
 Set the SNUB AUTO or SNUB ON or SNUB OFF.

Syntax **SNUB {SP} AUTO|ON|OFF {;}|NL}**

Set →
 → Query

OCP:START

Description Set and read the initial value of OCP test. This command is used for setting the required initial value (I-START) of OCP

Syntax **[PRESet:]OCP:START{SP}{NR2}{;}|NL}**

Query Syntax **[PRESet:]OCP:START?}{;}|NL}**

Set →
 → Query

OCP:STEP

Description Set and read the increasing value of OCP test. This command is used for setting the increasing value (I-STEP) of OCP test.

Syntax **[PRESet:]OCP:STEP{SP}{NR2}{;}|NL}**

Query Syntax **[PRESet:]OCP:STEP?}{;}|NL}**







Set →
 → Query

OCP:STOP

Description Set and read the maximum value of OCP test. This command is used for setting the maximum value (I-STOP) of OCP

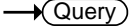
Syntax **[PRESet:]OCP:STOP{SP}{NR2}{;}|NL}**

Query Syntax **[PRESet:]OCP:STOEP?}{;}|NL}**

		 
<hr/>		
VTH		
<hr/>		
Description	Set and read the value of the threshold voltage. This command is used for setting the Threshold Voltage. That is the OCP/OPP of this Load model when the output voltage of appliance is lower or equaled to the VTH.	
Syntax	[PRESet:]VTH{SP}{NR2}{;} NL}	
Query Syntax	[PRESet:]VTH{?}{;} NL}	
<hr/>		
		 
<hr/>		
OPP:START		
<hr/>		
Description	Set and read the initial value of OPP test. This command is used for setting the required initial value (P-START) of OPP	
Syntax	[PRESet:]VTH{SP}{NR2}{;} NL}	
Query Syntax	[PRESet:]VTH{?}{;} NL}	
<hr/>		
		 
<hr/>		
OPP:STEP		
<hr/>		
Description	Set and read the increasing value of OPP test. This command is used for setting the increasing value (P-STEP) of OPP test.	
Syntax	[PRESet:]OPP:STEP{SP}{NR2}{;} NL}	
Query Syntax	[PRESet:]OPP:STEP{?}{;} NL}	
<hr/>		
		 
<hr/>		
OPP:STOP		
<hr/>		
Description	Set and read the maximum value of OPP test. This command is used for setting the maximum value (P-STOP) of OCP	
<hr/>		

Syntax [PRESet:]OPP:STOP{SP}{NR2}{;|NL}

Query Syntax [PRESet:]OPP:STOEP{?}{;|NL}

STIME

Set →

→ Query

Description Set and read time of the short-circuit test. This command is used for setting time of the short-circuit test. If time set to 0, it means that have no the time limit and continue to be short -circuited. The unit is milli-second (ms)

Syntax [PRESet:]STIME{SP}{NR2}{;|NL}

Query Syntax [PRESet:]STIME{?}{;|NL}

PF

Set →

→ Query

Description Set and read power factor. This command is set Power factor, the setting range is 0.01 ~ 1.00.

Syntax [PRESet:]PF{SP}{+|-}{NR2}{;|NL}

Query Syntax [PRESet:]PF{?}{;|NL}

CF

Set →

→ Query

Description Set and read crest factor. This command is set crest factor, the setting range is 1.0 ~ 5.0.

Syntax [PRESet:]CF{SP}{NR2}{;|NL}

Query Syntax [PRESet:]CF{?}{;|NL}

BATT:MODE

Set →

→ Query

Description Set and read the Battery test mode. This command is set and read the Battery test mode.

Syntax	[PRESet:]BATT:MODE{SP}{CC CR CV CP LIN}{:}; NL}
Query Syntax	[PRESet:]BATT:MODE{?}{:}; NL}
Parameter	<NR2>
	0 CC
	1 LIN
	2 CR
	3 CP

Set →

→ Query

BATT:TIME

Description Set and read the battery test time. This command is set and read the battery test time, the setting range is 1s~99999s.

Syntax [PRESet:]BATT:TIME{SP}{NR1}{:};|NL}

Query Syntax [PRESet:]BATT:TIME{?}{:};|NL}

DISC:TIME

→ Query

Description Read the battery discharge time. This command is when the test end, read the battery discharge time, the Range of 1s ~ 99999s.



Query Syntax [PRESet:]DISC:TIME{?}{:};|NL}

DISC:AH

→ Query

Description Read the battery capacity. This command is when the test end, read the battery capacity.

Query Syntax [PRESet:]DISC:AH{?}{:};|NL}

 	
EXTIN:ON/OFF	
Description	Set the external input signal. This command is to set EXTIN ON or OFF.
Query Syntax	[PRESet:]EXTIN:{SP}ON OFF}{: NL} [PRESet:]EXTIN?}{: NL}

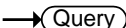
 	
TURBO:{SP}{ON OFF}	
Description	Set and read the TURBO mode can be set to ON or OFF. In TURBO mode, output double maximum rated current in short time.
Syntax	[PRESet:]TURBO{ON OFF}{: NL}
Query Syntax	[PRESet:]TURBO?}{: NL}
Parameter	<NR2>
	0 OFF
	1 ON

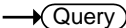
	
TRIP:TIME	
Description	Read the fuse fusing time. This command is when the test end, read the fuse fusing time.
Query Syntax	[PRESet:]TRIP:TIME?}{: NL}

	
TRANS:TIME	
Description	Read UPS Transfer time. This command is when the test end, read the UPS Transfer time.
Query Syntax	[PRESet:]TRANS:TIME?}{: NL}

AVG

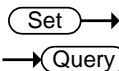

Description Set and read back the average 1, 2, 4, 8, and 16. Set and read back the average 1, 2, 4, 8, and 16, the default is 1 without Averaging.

Syntax [PRESet:]AVG{SP}{NR2}{:};|NL}

Query Syntax [PRESet:]AVG{?}{:};|NL}

Parameter <NR2>

1

2

4

8

16

CPRSP

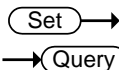

Description Set and read back the CPRSP 0~7.
 CPRSP is set to constant power response.
 0 ~ 3 response time for linear current constant power mode, that means linear current waveform with constant power mode, the current waveform will follow the voltage waveform, and 0 is the fastest, and 3 is the slowest.
 4 ~ 7 response time for standard current with constant power, which means the constant power mode can support CF waveform, and 4 is fastest, 7 is slowest.

Syntax [PRESet:]CPRSP{SP}{NR2}{:};|NL}

Query Syntax [PRESet:]CPRSP{?}{:};|NL}

Parameter <NR2>

0~7

CYCLE

Description Set and read back the CYCLE. It can be set from 1 to 16. Default setting set is 8. That is 8 cycles to do the meter value processing.

Syntax `[PRESet:]CYCLE{SP}{NR2}{:}|NL}`

Query Syntax `[PRESet:]CYCLE{?}{:}|NL}`

Parameter `<NR2>`

1~16

BW

Description Set and read the BW 0~15. Set and read the bandwidth from 0 to 15 bandwidth, 15 is the fastest, and the initial value is AUTO. In BW AUTO, set the load current to be 14 when the load current is less than 1/3 of the specification, and automatically set to 13 when it's greater than 1/3 of the specification.

Syntax `[PRESet:]BW{SP}{AUTO|NR2}{:}|NL}`

Query Syntax `[PRESet:]BW{?}{:}|NL}`

FREQ

Description Set and read the frequency. For frequency detect by automatically setting; FREQ AUTO; the system will detect the input voltage, if the input voltage frequency not between 40 and 440Hz that will be setting to DC.

For frequency setting to DC; FREQ 0; setting the frequency to 0 means DC.

For fix frequency setting to 50 or 60 or 400Hz; FREQ 50.0 or FREQ 60.0 or FREQ 400.0.

Syntax	[PRESet:]FREQ{SP}{AUTO NR2}{; NL}
Query Syntax	[PRESet:]FREQ{?}{; NL}
Parameter	<NR2>
	0,40~440Hz

REP:COUNT → Query

Description Read the number of repeated tests.

Query Syntax [PRESet:]REP:COUNT{?}{;|NL}

Set →

ITHD:PCT → Query

Description Set and read the percentage of the ITHD. Set the percentage of ITHD of the current, range from 00% ~ 25%

Syntax [PRESet:]ITHD:PCT{SP}{NR2}{;|NL}

Query Syntax [PRESet:]ITHD:PCT{?}{;|NL}

Set →

ITHD:CC → Query

Description Set and read the current value. Set the current value for the electronic load starts loading in ITHD mode.

Syntax [PRESet:]ITHD:CC{SP}{NR2}{;|NL}

Query Syntax [PRESet:]ITHD:CC{?}{;|NL}

Set →

IMODE → Query

Description Set and read the inrush current test. Select constant current or constant resistance for loading in inrush current test.

Syntax **IMODE{SP}{CC|CR|0|1}{;|NL}**
 Query Syntax **IMODE{?}{;|NL}**

RSTART

Set →
 → Query

Description Set and read the initial resistance of the inrush current test.

Syntax **RSTART{SP}{NR2}{;|NL}**
 Query Syntax **RSTART{?}{;|NL}**

RSTEP

Set →
 → Query

Description Set and read the incremental resistance of the inrush current test.

Syntax **RSTEP{SP}{NR2}{;|NL}**
 Query Syntax **RSTEP{?}{;|NL}**

RSTOP

Set →
 → Query

Description Set and read the terminal resistance of inrush current test.

Syntax **RSTOP{SP}{NR2}{;|NL}**
 Query Syntax **RSTOP{?}{;|NL}**

IPEAK

Set →
 → Query

Description Set and read the peak current of inrush current test, and the maximum value of the setting range is 5 times of the specification.

Syntax **IPEAK{SP}{NR2}{;|NL}**
 Query Syntax **IPEAK{?}{;|NL}**

ICYCLE

Set →
→ Query

Description Set and read the cycle of the inrush current test. In the inrush current test AC mode, the setting unit of the current decreasing time is cycle, and the setting range is from 0.5 to 5.0.

Syntax ICYCLE{SP}{NR2}{:}{|NL}

Query Syntax ICYCLE{?}{:}{|NL}

FUSE:TIME_n

Set →
→ Query

Description Set and read the loading time for fuse test current. The command is to set or read the fuse test loading time, the setting range is as follows:
n:1~3. The time value of loading current in each stage.
n:1~2. Time setting range: 0.01~0.50 sec.
n:3. Time setting range: 0.01~600 sec.

Syntax [PRESet:]FUSE:TIME_n{SP}{NR2}{:}{|NL}

Query Syntax [PRESet:]FUSE:TIME_n{?}{:}{|NL}

FUSE:CYCLE

Set →
→ Query

Description Set and read the fuse repeat tests number of times. Set and read the fuse repeat tests number of times. The setting range is 0 ~ 99999.

Syntax [PRESet:]FUSE:CYCLE{SP}{NR2}{:}{|NL}

Query Syntax [PRESet:]FUSE:CYCLE{?}{:}{|NL}

FUSE:CCn

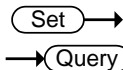

Description

Set and read fuse test current value.

The command is used to set or read the fuse test current value; the setting range is as follows:

n:1~3. The load current value in each stage.

n:1~2. The current setting range is twice the specification.

n:3. The current setting range is the specification of the current.

Syntax

[PRESet:]FUSE:CCn{SP}{NR2}{;|NL}

Query Syntax

[PRESet:]FUSE:CCn?}{;|NL}

FUSE:STEP

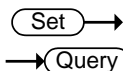

Description

Set and read the selected setting value.

This command is used to set or read the selected setting value. The setting range is 1~3 as follows:

1: Select the loading current and time of CC1.

2: Select the loading current and time of CC1+CC2.

3: Select the loading current and time of CC1+CC2+CC3

Syntax

[PRESet:]FUSE:STEP{SP}{NR2}{;|NL}

Query Syntax

[PRESet:]FUSE:STEP?}{;|NL}

FUSE:OFFTIME

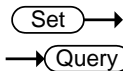

Description

Set and read the interval for fuse repeat tests.

This command is to set or read the interval time of fuse repeat tests. The setting range is 0~99999.

Syntax [PRESet:]FUSE:OFFTIME{SP}{NR2}{:}|NL}
 Query Syntax [PRESet:]FUSE:OFFTIME(?){:}|NL}

FUSE:TYPE



Description Set and read fuse type.
 This command is to set or read fuse TRIP or NTRIP.

Syntax [PRESet:]FUSE:TYPE{SP}{TRIP|NTRIP}{:}|NL}
 Query Syntax [PRESet:]FUSE:TYPE(?){:}|NL}

BATT:FREQ



Description Set and read the selected AC or DC mode.
 This command is for the AC/DC mode selection during battery test.

Syntax [PRESet:]BATT:FREQ{SP}{AC|DC}{:}|NL}
 Query Syntax [PRESet:]BATT:FREQ(?){:}|NL}

Limit Commands

Set and read the top and bottom of the Load judgment NG limit

[LIMit:]CURRent:{HIGH|LOW} or IH|IL (Set) →
→ (Query)

Description This command is to set the lower limit value of threshold current. When load sink current is lower than this lower limit value or higher than the upper limit value, NG indicating light will come on to indicate “NO GOOD”.

Syntax [LIMit:]CURRent:{HIGH|LOW}{SP}{NR2}{:|NL}
[IH|IL]{SP}{NR2}{:|NL}

Query Syntax [LIMit:]CURRent:{HIGH|LOW}{?}{:|NL}
[IH|IL]{?}{:|NL}

[LIMit:]POWer:{HIGH|LOW} or WH|WL (Set) →
→ (Query)

Description This command is to set the upper/lower limit value of threshold power (WATT). When power (WATT) is lower than this lower limit value or higher than the upper limit value, NG indicating light will come on to indicate “NO GOOD”

Syntax [LIMit:]POWer:{HIGH|LOW}{SP}{NR2}{:|NL}
[WH|WL]{SP}{NR2}{:|NL}

Query Syntax [LIMit:]POWer:{HIGH|LOW}{?}{:|NL}
[WH|WL]{?}{:|NL}

[LIMit:]VOLtage:{HIGH|LOW} or VH|VL (Set) →
→ (Query)

Description This command is to set the upper/lower limit value of threshold voltage. When input voltage is lower than the lower limit value or higher than the upper limit value, NG indicating light will come on to indicate "NO GOOD".

Syntax [LIMit:]VOLtage:{HIGH|LOW}{SP}{NR2 }{;|NL}
[VH|VL]{SP}{NR2 }{;|NL}

Query Syntax [LIMit:]VOLtage:{HIGH|LOW}{?}{;|NL}
[VH|VL]{?}{;|NL}

SVH|SVL (Set) →
→ (Query)

Description This command is to set the upper/lower limit value of short current. When short current is lower than the lower limit value or higher than the upper limit value, set the upper limit of the comparison voltage. When the input voltage is higher than the upper limit, it means that the short circuit test has failed.

Syntax [LIMit:]{SVH|SVL}{SP}{NR2 }{;|NL}

Query Syntax [LIMit:]{SVH|SVL}{?}{;|NL}

STATE commands

Set and read the status of Load

Set →

→ Query

[STATe:]LOAD{SP}{ON|OFF}

Description	Set and read the status of Sink Current or not. This command is used for setting the status of Sink Current. When setting it to ON, the Load is going to sink current from appliance. When setting it to OFF, the Load would not act.
-------------	---

Syntax	[STATe:]LOAD{SP}{ON OFF}{: NL}
--------	---------------------------------------

Query Syntax	[STATe:]LOAD?}{: NL}
--------------	-----------------------------

Parameter	0	OFF
	1	ON

Set →

→ Query

[STATe:]MODE{SP}{CC|CR|CV|CP}

Description	Set and read the mode of LOAD. Load is acting under these four modes as the following table. When reading the Loading Operation mode, the return value 0 1 2 3 4 are meant to be CC LIN CR CV CP
-------------	--

Syntax	[STATe:]MODE{SP}{CC CR CV CP}{: NL}
--------	--

Query Syntax	[STATe:]MODE?}{: NL}
--------------	-----------------------------

Module for each series	Model	CC	LIN	CR	CV	CP
	(Value)	0	1	2	3	4
	AEL-5002-350-18.75	V	V	V	V	V
	AEL-5003-350-28	V	V	V	V	V
	AEL-5004-350-37.5	V	V	V	V	V
	AEL-5006-350-56	V	V	V	V	V
	AEL-5008-350-75	V	V	V	V	V
	AEL-5012-350-112.5	V	V	V	V	V
	AEL-5015-350-112.5	V	V	V	V	V
	AEL-5019-350-112.5	V	V	V	V	V
	AEL-5023-350-112.5	V	V	V	V	V
	AEL-5002-425-18.75	V	V	V	V	V
	AEL-5003-425-28	V	V	V	V	V
	AEL-5004-425-37.5	V	V	V	V	V
	AEL-5006-425-56	V	V	V	V	V
	AEL-5008-425-112.5	V	V	V	V	V
	AEL-5012-425-112.5	V	V	V	V	V
	AEL-5015-425-112.5	V	V	V	V	V
	AEL-5019-425-112.5	V	V	V	V	V
	AEL-5023-425-112.5	V	V	V	V	V
	AEL-5003-480-18.75	V	V	V	V	V
	AEL-5004-480-28	V	V	V	V	V

Set →

→ Query

[STATe:]PRESet{SP}{ON|OFF}

Description Set the left or right digit multi-function meter to display the programming load level. This command is for select the left 5 digit LCD display to show current setting or DWM.

Pres ON: To select the LCD display to shows current setting.

Pres OFF: To select the LCD Display is “DWM”

Syntax [STATe:]PRESet{SP}{ON|OFF}{:|NL}

Query Syntax [STATe:]PRESet{?}{:|NL}

Parameter

0	OFF
1	ON

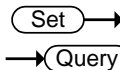

[STATe:]SENSe{SP}{ON|OFF}

Description Set and read the Load voltage to read whether is carried by the VSENSE or not. This command is for setting the Load voltage to read whether is carried by VSENSE or INPUT Connector. When setting for ON, the voltage is got from VSENSE, and setting for OFF, the voltage is got from INPUT Connector.

Syntax **[STATe:]SENSe{SP}{ON|OFF }{;|NL}**

Query Syntax **[STATe:]SENSe?){;|NL}**

Parameter	0	OFF
	1	ON

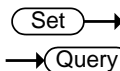

[STATe:]LEVeL{SP}{A|B} or LEV{SP}{A|B}

Description Set and read the A and B of Load. LEV LOW is a low level value of current on CC mode. It is a low level value of resistance on CR mode. It is a low level value of voltage on CV mode. It is a low level value of power on CP mode.

Syntax **[STATe:]LEVeL{SP}{A|B }{;|NL}**
[STATe:]LEV{SP}{A|B}{;|NL}

Query Syntax **[STATe:]LEVeL?){;|NL}**
[STATe:]LEV?){;|NL}

Parameter	0	A
	1	B

[STATe:]CLRerr (Set) →

Description Clear the error flag of AEL-5000 series which during the period of working. This command is for clearing the contents in the register of PROT and ERR. After implementation, the contents of these two registers will be "0".

Syntax **[STATe:]CLRerr{;|NL}**

[STATe:]CLR:Meter (Set) →

Description Clear the meter record value. Clear the maximum and minimum recorded values of the RMS measured by the meter.

Syntax **[STATe:]CLR:Meter{;|NL}**

[STATe:]ERRor → (Query)

Description Read status register value.

1. ERR?: Read the register of ERR status. The table below shows the corresponding number of ERR status.
2. Use command CLR to clear the register of ERR status to be "0".

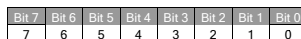

— ERROR COMMAND

BIT ID	BIT VALUE	REMARK
bit 5	0 = Off, 1 = Triggered	Command error (e.g. syntax error)

Query Syntax **[STATe:]ERRor{?}{;|NL}**

[STATe:]NG?

→ (Query)

Description Query if there have NG flag in this AEL-5000 series. Set command NG? To show the NG status. Set for "0" the LCD of NG (NO GOOD) will be put out. Set "1", the LCD will be lit.

Query Syntax **[STATe:]NG{?}{;|NL}**

Return Parameter	0	GO
	1	NG

[STATe:]PROTect?

→ (Query)

Description Query if there have protection flag which had been set in this AEL-5000 series. PROT? Means the status of Protection of AEL-5008-350-75. "1" means OPP occurred. "4" means OVP. "8" means OCP. The table below shows the corresponding number of protection status use command CLR to clear the register of PROT status to be "0"

Query Syntax **[STATe:]PROTect{?}{;|NL}**

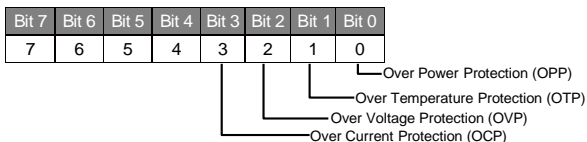

Register of PROT status	BIT ID	BIT VALUE	REMARK
	bit 0	0 = Off, 1 = Triggered	Over Power Protection (OPP)
	bit 1	0 = Off, 1 = Triggered	Over Temperature Protection (OTP)
	bit 2	0 = Off, 1 = Triggered	Over Voltage Protection (OVP)
	bit 3	0 = Off, 1 = Triggered	Over Current Protection (OCP)

[STATe:]NGEABLE {ON|OFF}

 →

Description Set the GO/NG check function enable or disable.
To set the function of NG judgment opens when POWER ON. When setting for POWER OFF, the function of NG judgment will not be implemented.

Syntax [STATe:]NGEABLE{ON|OFF}{:}|NL}

[STATe:]START

 →

Description Set for load to implement the test, and according to TEST CONFIG (TCONFIG), the Load will start to test the items and parameters which are required

Syntax [STATe:]START{:}|NL}

[STATe:]STOP

 →

Description Set for load to stop the test

Syntax [STATe:]STOP{:}|NL}

[STATe:]TESTING?

 →

Description Check whether the current electronic load is in the test state, 1: testing 0: test end.

Syntax [STATe:]TESTING{?}{:}|NL}

Return Parameter	0	Test END
	1	Testing

Example START
 TESTING?
 NG?
 STOP

[STATe:]SYNCronize

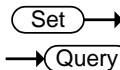

Description Electronic load sync signal. 1: SYNC ON 0: SYNC OFF.

Syntax **[STATe:]SYNCronize{SP}{ON|OFF}{:|NL}**

Query Syntax **[STATe:]SYNCronize{?}{:|NL}**

Return Parameter	0	OFF
	1	ON

System Commands

Set and Read the Status of AEL-5000 series

[SYStem:]RECall{SP}m{n}

Set →

Description Recall the status of loading which had been saved in the Memory. This command is for recalling the status of Load which had been saved in the Memory. m(STATE)=1~150.

Syntax [SYStem:]RECall{SP}m{n};|NL}

Example **RECALL 2**

Recall the status of Loading which had been saved in the 2nd of the memory

[SYStem:]STORe{SP}m{n}

Set →

Description Save the status of Loading to the Memory. This command is for saving the status of Loading to the Memory. m(STATE)=1~150

Syntax [SYStem:] S{n}TORe{SP}m{n};|NL}

Example **STORE 2**

Save the status of loading which had been saved in the 2nd of memory.

[SYStem:]NAME?

→ **Query**

Description Read the model number of Load. This command is for reading the model number of Load. If no module is operating, the display will be lit "NULL", or it will be lit the model number

Model
(Value)
AEL-5002-350-18.75
AEL-5003-350-28
AEL-5004-350-37.5
AEL-5006-350-56
AEL-5008-350-75
AEL-5012-350-112.5
AEL-5015-350-112.5
AEL-5019-350-112.5
AEL-5023-350-112.5
AEL-5002-425-18.75
AEL-5003-425-28
AEL-5004-425-37.5
AEL-5006-425-56
AEL-5008-425-75
AEL-5012-425-112.5
AEL-5015-425-112.5
AEL-5019-425-112.5
AEL-5023-425-112.5
AEL-5003-480-18.75
AEL-5004-480-28

Query Syntax **[SYStem:]NAME{?}{;|NL}**

[SYStem:]REMOTE

Set →

Description Command to enter the REMOTE status (only for RS232). This command is for controlling the RS232

Syntax **[SYStem:]REMOTE{;|NL}**

[SYStem:]LOCAL**Set** →

Description Command to exit the REMOTE status (only for RS232). This command is for finishing the RS232

Syntax **[SYStem:]LOCAL{;|NL}**

[SYStem:]*RST**Set** →

Description Execute the reset action. This command will reset the machine, and after reset, all settings and status will return to the same default value after power on.

Syntax **[SYStem:]*RST{;|NL}**

[SYStem:]SN→ **Query**

Description Read the serial number 1~15 characters.

Syntax **[SYStem:]SN{?}{;|NL}**

Measure Commands

Measure the actual current and voltage value of Load

MEASure:CURRent?

→ Query

Description	Read the current which is loading of Load. Read the five numbers of current meters, and the unit is Ampere (A)
-------------	--

Query Syntax	MEASure:CURRent{?}{; NL}
--------------	---------------------------------

MEASure:VOLTage?

→ Query

Description	Read the voltage which is loading of Load. Read the five numbers of voltage meters, and the unit is Voltage (V)
-------------	---

Query Syntax	MEASure:VOLTage{?}{; NL}
--------------	---------------------------------

MEASure:POWer?

→ Query

Description	Read the power which is loading of Load. Read the five numbers of power meters, and the unit is Watt (W)
-------------	--

Query Syntax	MEASure:POWer{?}{; NL}
--------------	-------------------------------

MEASure:VAR?

→ Query

Description	Read the reactive power which is loading of Load, Unit is Var.
-------------	--

Query Syntax	MEASure:VAR{?}{; NL}
--------------	-----------------------------

MEASure:VA? → Query

Description Read the apparent power which is loading of load.
Unit is VA

Query Syntax **MEASure:VA{?}{;|NL}**

MEASure:V_THD? → Query

Description Read the voltage harmonic distortion of the Load.

Query Syntax **MEASure:V_HD{?}{;|NL}**

MEASure:I_THD? → Query

Description Read the current harmonic distortion of the Load.

Query Syntax **MEASure:I_HD{?}{;|NL}**

MEASure:V_HARM? → Query

Description Read the voltage harmonic distortion order of the load.

Query Syntax **MEASure:V_HARM{?}{;|NL}**

MEASure:I_HARM? → Query

Description Read the current harmonic distortion order of the Load.

Query Syntax **MEASure:I_HARM{?}{;|NL}**





MEASure:VC

→ **Query**

Description Read the voltage and current. Read the value of voltmeter and ammeter, the unit is volts (V) and amperes (A).

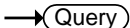
Query Syntax **MEASure:VC{?}{:|NL}**

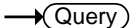
Auto Sequence Commands

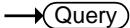
		 →  →
FILE{SP}{n}{; NL}		
Description	Set file numbers of Auto Sequence. Reads the automatic test number setting of the AUTO Sequence function and the set automatic test number. The setting range is 1-9, and the number is the automatic test number.	
Syntax	FILE{SP}{n}{; NL}	
Query Syntax	FILE{?}{; NL}	
		 →  →
STEP{SP}{n}{; NL}		
Description	Set step numbers of sequence step. The n is 1~32.	
Syntax	STEP{SP}{n}{; NL}	
Query Syntax	STEP{?}{; NL}	
		 →  →
TOTSTEP{SP}{n}{; NL}		
Description	Set total step numbers of sequence step. The n is 1~32.	
Syntax	TOTSTEP{SP}{n}{; NL}	
Query Syntax	TOTSTEP {?}{; NL}	

SB{SP}{m,n}{;|NL}

 Set →
 → Query

Description Set and Read the memory bank.

Set the step execution content to the step with the automatic test number set by the "STEP" command.

The step execution contents are various setting states (up to 150 types) saved in the AEL-5000 series memory. The setting range is 1: Various setting states 1~150: Various setting states 150.

Syntax **SB{SP}{m,n}{;|NL}**

Query Syntax **SB{?}{;|NL}**

TIME{SP}{m,n}{;|NL}

Set →

Description The setting range is 100-9999, and the unit is "ms".

Set the step execution time of the automatic test number set by the "STEP" command, and read the set step execution time.

Syntax **TIME{SP}{m,n}{;|NL}**

SAVE{;|NL}

Set →

Description Save auto sequence data..

Saves the settings of the automatic test number set by the "FILE" command.

Syntax **SAVE{;|NL}**

REPEAT{SP}{n}{;|NL}

Set →

 → Query

Description Set repeat time for the sequence step.

 Reads the execution repeat count setting of the automatic test number set by the "FILE" command and the set repeat count.

 Setting range: 0-9999

Syntax **REPEAT{SP}{n}{;|NL}**

Query Syntax **REPEAT?}{;|NL}**

RUN{SP}{F}{n}{;|NL}

Set →

Description "Run" the sequence file number.

 Specify an automatic test number and run the automatic test against that number. Specified range: 1 to 9. When the automatic test is finished, you will receive an auto reply.

Syntax **RUN{SP}{F}{n}{;|NL}**

A APPLICATION

This chapter details the basic operating modes along with some common applications in which the AEL-5000 series Electronic Load is used.

Local sense connections	213
Remote sense connections	215
Constant Current mode and LIN mode application.....	217
Constant Resistance mode application	219
Constant Voltage mode application	221
Constant Power mode application	223
Battery discharge test application	225
Current protection component test.....	229
AC rectified load simulation.....	232
Parallel operation	233
Inrush Current	235
Power Supply OCP testing	238
Power Supply OPP testing	241
SHORT testing.....	244
BW Setting.....	246
Special waveform applications	247

Local sense connections

Background

Local sensing is used in applications where the lead lengths are relatively short, or where load regulation is not critical. When connected in local sense mode the 5 digit voltage meter of the AEL-5000 series electronic load measures the voltage at its DC input terminals. The connecting leads between the DUT and the Electronic Load should be bundled or tie wrapped together to minimize inductance.

The diagram below illustrates a typical set up with the electronic load connected to the DC power supply.

Local voltage sense connections

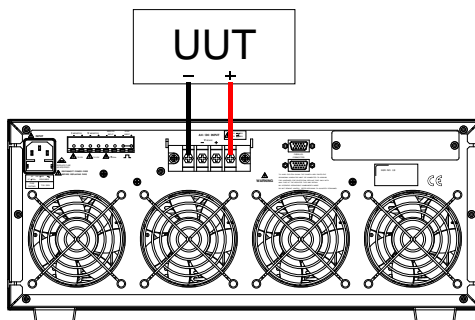

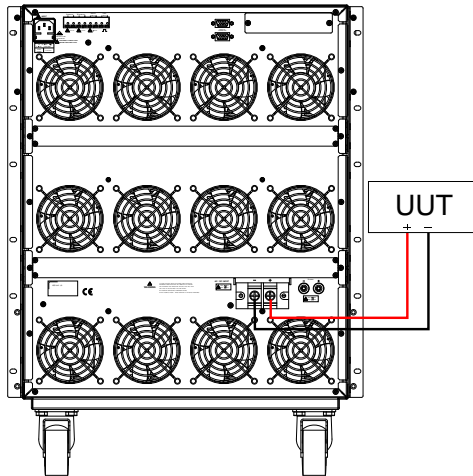

Remote sense connections

Background

Remote sensing compensates for the voltage drop in applications that require long lead lengths. It is useful under low voltage high current conditions. The remote voltage sense terminals (V_s+) and (V_s-) of the load are connected to (+) and (-) output of the AC/DC Source. Be sure to observe the correct polarity or damage may occur. The power and sense cables should be bundled or tie wrapped together to minimize inductance.

The diagram below illustrates a typical set up with the electronic load connected for remote sense operation.

If V-sense is set to 'ON' and the sense terminals are connected to the DUT the load will check and compensate for all voltage drops. The maximum voltage sense compensation is the same as the rating of the AEL-5008-350-75.

Remote voltage sense connections

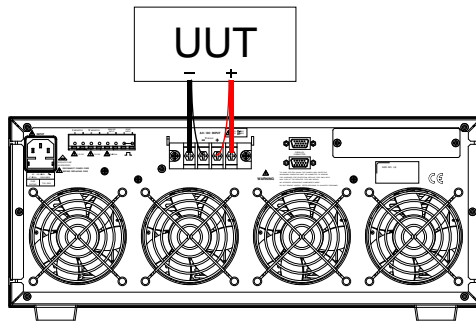

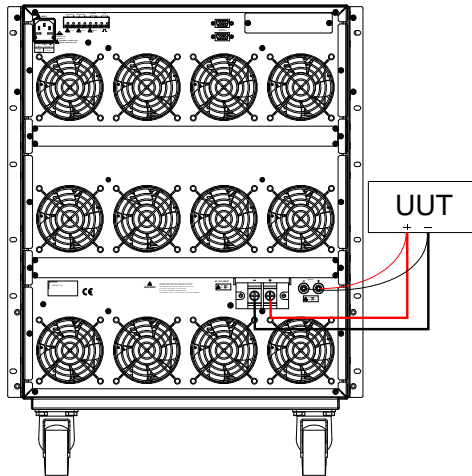

Constant Current mode and LIN mode application

Background

The Constant Current (CC) mode is ideal for testing the Load Regulation, Cross Regulation, Output Voltage and Dynamic Regulation of the power supply under test. The CC mode can also be used to test the Discharge Characteristics and the Life Cycle of cells and battery packs. In CC operation the AEL-5000 series can operate as a static load with switchable high and low current levels. It is also possible to operate the load dynamically enabling the user to adjust sink current with time.

During Linear C.C. mode, the load current input into AEL-5000 series High Power Electronic Load depends on the current setting regardless of the input voltage, e.g., the current setting remains unchanged. The load input current signal will follow input voltage signal that is useful for step wave-form and square wave-form device.

The LIN mode is within a AGC circuit and the control signal will response with input voltage. We call it LIN mode.

The AGC circuit produces a constant amplitude output signal so long as the amplitude of the input signal exceeds an adjustable reference voltage applied to the peak detector. The reference voltage may be changed to change the range of input voltage resulting in a constant-amplitude output.

The AGC circuit responds almost instantly to control a sudden increase in input voltage.

The AGC circuit is especially suitable for Step waveform, Square waveform and the input

voltage with distortion waveform.

Constant current
and mode
application

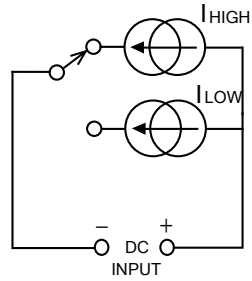
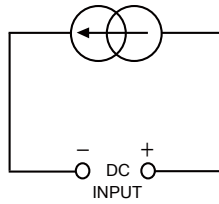
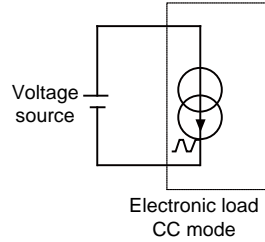
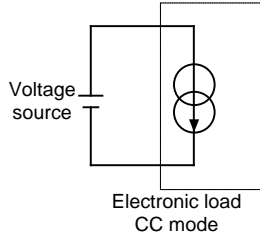

Constant Resistance mode application

Operating in Constant Resistance mode is useful for testing both voltage and current sources. The CR mode is particularly suited for the “soft start” of power supplies. This is explained in more detail below.

Power supply
power up
sequence

Power supply power up sequence
In constant current mode the demand at initial “Load ON” of the preset current value is almost instantaneous. This might cause the Device under Test (DUT) problems meeting the relatively high current demand at initial switch on.

Example

A 5V/50A output power supply may not be able to deliver 50A over its entire start-up range of 0-5 volts. In many cases the power supply’s short circuit or over current protection circuit cause the power supply to shut down. This is because the power supply is trying to deliver the 50A at a voltage level that is too low.

The answer to this problem is not to use CC mode but to use CR mode instead. This is because in CR mode the current and voltage ramp up together providing a ‘soft start’ when compared to standard CC mode.

Constant
Resistance mode
Application

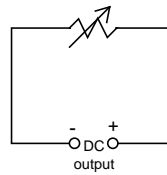
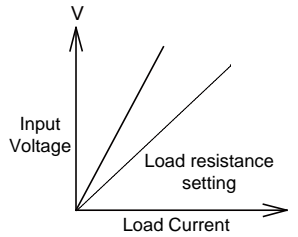
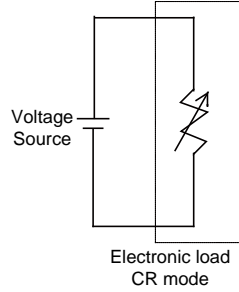
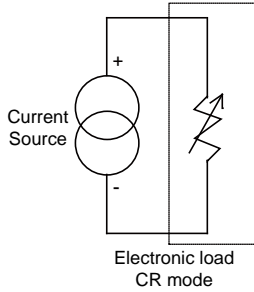

Constant Voltage mode application

In Constant Voltage (CV) operation the load will attempt to sink as much current as required in order to reach the set voltage value. CV operation is useful in checking the load regulation of dc current sources. The CV mode is also ideal for characterizing the current limit of dc power supplies. These application areas are explained a little more below.

Current source testing

A common application for a dc current source is as a battery charger. Most battery chargers are designed to automatically adjust their charging current according to the battery voltage. In CV mode the electronic load will sink the current that is needed to reach the desired voltage. The CV mode is therefore ideal for checking the charge current at a particular voltage level.

Set the CV voltage value, press the MODE key to CV MODE, press the Preset key, use the knob and key to set the CV voltage value, set the voltage range from 0 to 500V, and adjust the different voltage values according to the EUT.

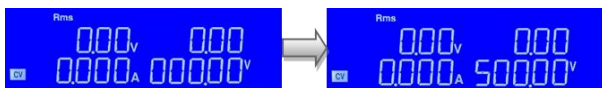

Set the CV starting current, press the MODE key to CV MODE, press the Preset key to INT I, use the knob and key to set the starting current, set the current range from 0 to 37.5A, and adjust the different current values according to the EUT.

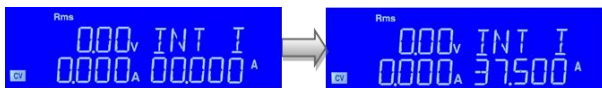

If the battery charger is tested at a number of different voltage levels in CV mode a current curve can be recorded. Thus the battery charger's load regulation can be checked during

development, production and batch testing.

Power supply current limit characterization

The current limit is a necessary function for power supplies. The fold back current limit curve is very common for fixed output switching power supplies. The constant current limit curve is more popular for adjustable laboratory power supplies.

It is very difficult or impossible to find the current limit curve by CC or CR mode. However it becomes simple by using CV mode. The user sets the CV voltage and Records the output current. Plotting the current measurements against the voltage Settings result in the output current limit curve of a power supply.

Constant Voltage mode application

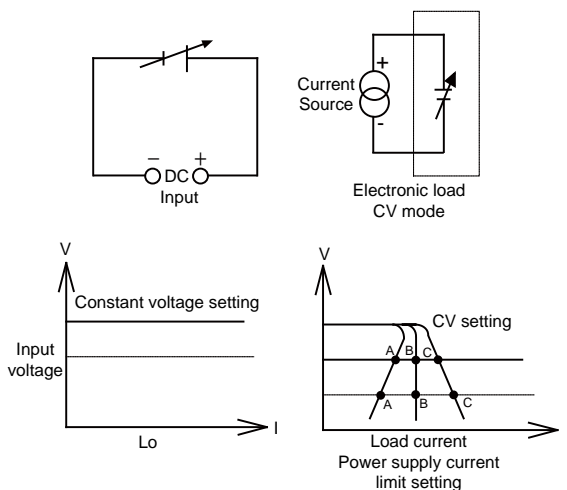

Constant Power mode application

Battery Evaluation Primary or secondary batteries are the power source for a wide range of portable electronics products, such as notebook computers, video cameras and mobile phones. To ensure long usage times and customer satisfaction the battery pack should be able to provide a constant power for the longest time possible.

It can be measured that the output voltage of a battery will drop over time (Fig a). The rate of voltage decay depends on a number of factors including duty cycle, chemistry type, battery age and ambient temperature.

So to keep the device powered for the longest possible time the battery must be able to provide a stable power output regardless of output voltage (Fig c). In order to maintain a constant power the output current will need to increase over time to compensate for the reducing voltage (Fig b).

Operating the AEL-5000 series electronic load in CP mode is ideal for testing the characteristics of a battery. This is because as the battery voltage drops the load current will automatically increase in order to keep the CP setting. By logging sink values against time the test engineer can also measure the battery's energy capacity at various discharge rates.

The AEL-5000 series also features an adjustable Load OFF setting. This allows a voltage level to be set so that the electronic load automatically stops sinking power upon reaching this preset voltage. This can be used to ensure the battery is not subjected to a damaging deep discharge.

Along with static operation the load can also be

operated dynamically in CP mode.

Constant power mode application

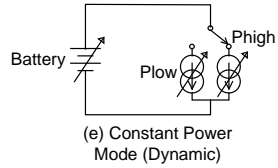
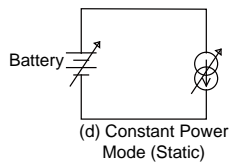
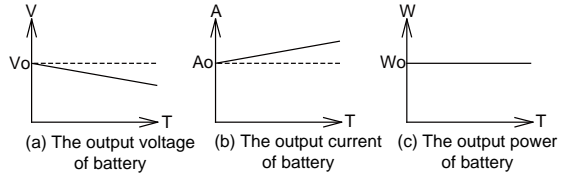

Battery discharge test application

The AEL-5000 series AC & DC electronic load has built-in new TYPE1 ~ TYPE3 battery discharge test, you can select the desired battery test mode, the test results can be directly displayed on the LCD display for battery AH capacity, the voltage value after discharge and the cumulative discharge time.

Constant Current Discharge Test

1. Set mode is constant current



2. Set discharge current



3. Set the crest factor.

This function is only used when testing UPS discharge. When testing the battery discharge is no CF function.



4. Set the Phase Lead or lag.

This function is only used when testing UPS discharge. When testing the battery discharge is no Phase Lead or lag function.



5. Set the Phase angle.

This function is only used when testing UPS

discharge. When testing the battery discharge is no Phase angle function.

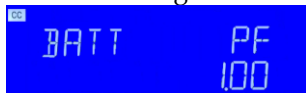

- Set the discharge time.



- Set the UVP Voltage.



CC+UVP Battery discharge mode Type 1

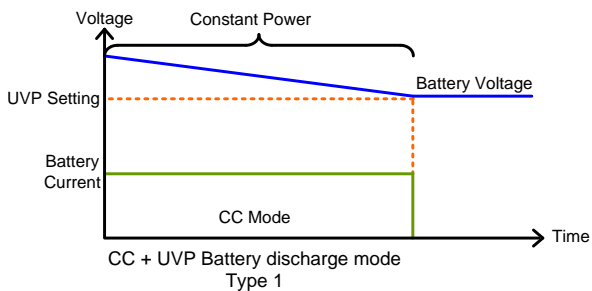

Constant Power Discharge Test

- Set mode is constant power.



- Set the discharge power.



- Set the crest factor.
This function is only used when testing UPS discharge. When testing the battery discharge is no CF function.



4. Set the Phase Lead or lag.
This function is only used when testing UPS discharge. When testing the battery discharge is no Phase Lead or lag function.



5. Set the Phase angle.
This function is only used when testing UPS discharge. When testing the battery discharge is no Phase angle function.

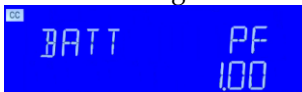

6. Set the discharge time.



7. Set the UVP Voltage.



CC+UVP Battery discharge mode Type 2

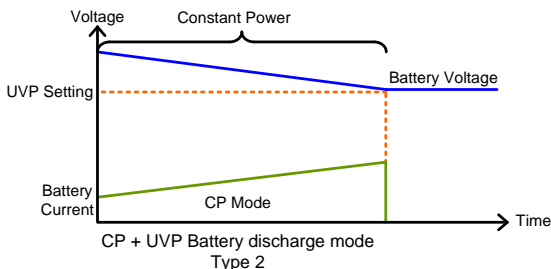

Setting the discharge time Test

1. Set the discharge time from 1 to 99999 seconds. When the discharge time reaches the set time, the discharge will automatically stop and the measured battery capacity and voltage will be monitored and displayed.



CC+UVP Battery discharge mode Type 3

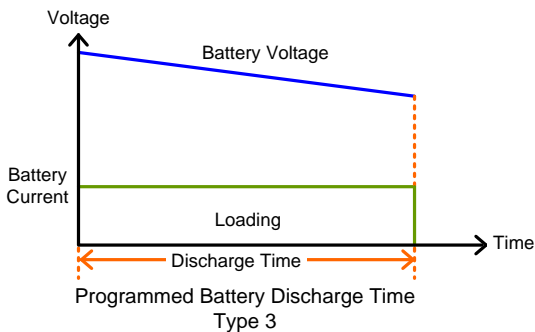

Current protection component test

Background

Current protection component include fuse, circuit breakers and a new PTC resettable fuse etc., its function is when the circuit current exceeds the design of the rated value. That is, if the load exceeds the design of the current capacity, the circuit will be disconnected, in order to avoid overheating, even fire. At the abnormal situation occurs it must be able to provide circuit break protection capability, while within the normal current range it must continue to provide current.



Fuse



Breaker



PTC

MODEL	AEL-5002-350-18.75	AEL-5003-350-28	AEL-5004-350-37.5		
Power(W)	1875W	2800W	3750W		
Current(Ampere)	18.75Arms/56.25Apek	28Arms/84Apek	37.5 Arms/12.5Apek		
Voltage(Volt)	50~350Vrms/500Vdc				
Fuse Test mode					
Max. current	Turbo OFF(CC1~3)	18.75Arms	28.0Arms	37.5Arms	
	Turbo ON	CC3			
		CC1~2	37.5Arms (x2)*3	56.0Arms(x2)*3	75.0Arms(x2)*3
Trip & non-trip time	Turbo OFF(TIME1~3)	0.01~333.33 sec.			
	Turbo ON	TIME 1~2	0.01~0.50 sec.		
		TIME3	0.01~600.00 sec.		
OFF TIME	0.01~9999.9 sec.				
Meas. Accuracy	±0.003 sec.				
Repeat Cycle	0~99999				
Short/OPP/OCB Test Function					
Short Time	Turbo OFF	0.1 ~10 sec. or Cont.			
	Turbo ON	0.1~1 sec.			
OPP/OCB Step Time	Turbo OFF	100ms			
	Turbo ON	100ms. Up to 10 Steps			
OCB Istop	Turbo OFF	18.75Arms	28.0Arms	37.5Arms	
	Turbo ON	37.5Arms	56.0Arms	75.0Arms	
OPP Pstop	Turbo OFF	1875W	2800W	3750W	
	Turbo ON	3750W	5600W	7500W	



Turbo OFF, Short 100ms 37.5A
Test result screen

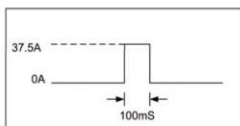

Turbo OFF, Short 100ms 37.5A Setting

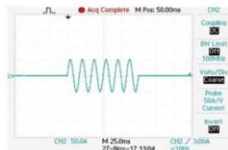

Turbo OFF, Short 100ms 37.5A
The actual test waveform



Turbo ON, Short 100ms 75.0A
Test result screen

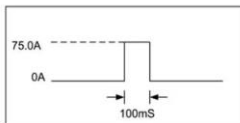

Turbo ON, Short 100ms 75.0A Setting

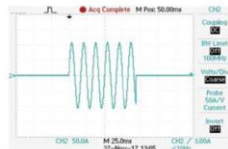

Turbo ON, Short 100ms 75.0A
The actual test waveform

The current protection component has usually a product relationship of current and time. That is, the greater the current through the current protection component, the shorter the reaction time to protect the circuit.

Due to this feature, the AEL-5000 series AC & DC electronic load, in particular for the verification of current protection components, has developed a Fuse Test function to test and verify such protection element with an electronic load of rated current and power.

Basically, Fuse test has Trip (fuse) and Non-Trip (no fuse) 2 types. Fuse test setting parameters include test current (Istart), test time (Time), test repeat number REPEAT TIME etc.

In the Trip fuse test, it is used to test when the current occurs too large abnormalities must be able to provide the protection of the circuit break that means current protection components need the fuse action, therefore the test current needs to be greater than the fuse current rating.

For the trip test mode of the AEL-5000 series AC & DC electronic load, the LCD shows the repeat times and the blow time of current protection component after the tested fuse blows. In the Non-Trip fuse

test, the current protection component is required to achieve non-blow action, so the test current needs to be lower than the fuse current rating that is used to verify the fuse must not blow during normal current range. For the Non-trip test mode of the AEL-5000 series AC & DC electronic load, the LCD display shows Repeat number information after the tested fuse does not blow.



Turbo : OFF, Fuse mode
Test result screen

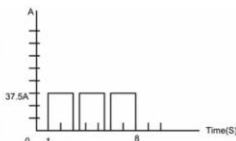

Setting : Turbo : OFF, Fuse ON
CC pulse 37.5A, 2S, Test 3 cycles

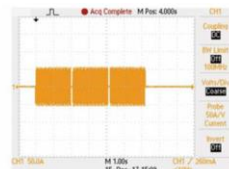

Turbo : OFF, Fuse ON, CC pulse 37.5A, 2S,
Test 3 cycles the actual test waveform



Turbo ON, Fuse mode
Test result screen

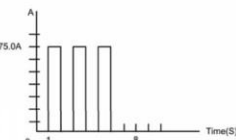

Setting : Turbo : ON, Fuse ON
CC pulse 75.0A, 1S, Test 3 cycles

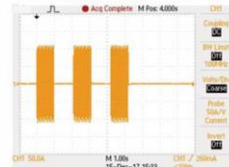

Turbo : ON, Fuse ON, CC pulse 75A, 1S,
Test 3 cycles the actual test waveform

AC rectified load simulation

Background

The AEL-5000 series AC/DC electronic load AC rectified load mode is fully compliance with the IEC test specification requirements for the UPS, IEC 62040-3 UPS Efficiency Measurement Non-linear and IEC 61683 Resistive Plus Non-Linear, respectively, AEL-5000 series AC rectifier load mode is used CC + CR load mode and maintain current THD at 80%, to simulate the actual electronic device which is connecting the UPS. (IEC62040-3 UPS Efficiency Measurement non-linear and IEC61683 Resistive Plus Non-linear)

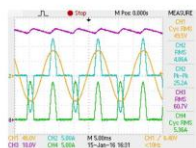
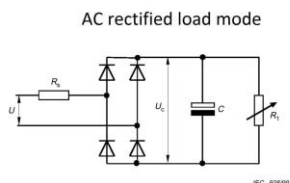

V/A Waveform

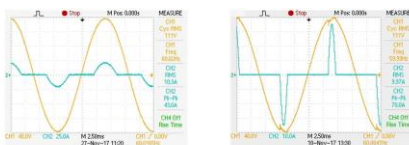

UPS test Non-Linear CC mode

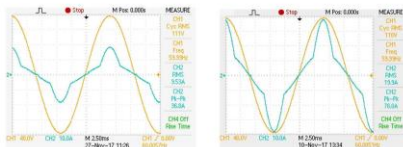

110V, 5A + 22ohm Test Waveform 110V, 10A + 11ohm Test Waveform
PV Inverter test Non-Linear CC + Resistive mode(CC+CR)

Parallel operation

Background

It is possible to operate load in parallel if the power and/or current capability of a single AEL-5000 series load is not sufficient.

The positive and negative outputs of the power supply are connected individually to each load module as shown in the Fig below. The setting is made at each individual load module. The total load current is the sum of the load currents being taken by each load.

While in static mode the load modules can be set to operate in CC, CR or CP. When using multiple loads to sink power from a single DC Source it is not permissible to operate in dynamic mode.

AEL-5000 series load parallel operation

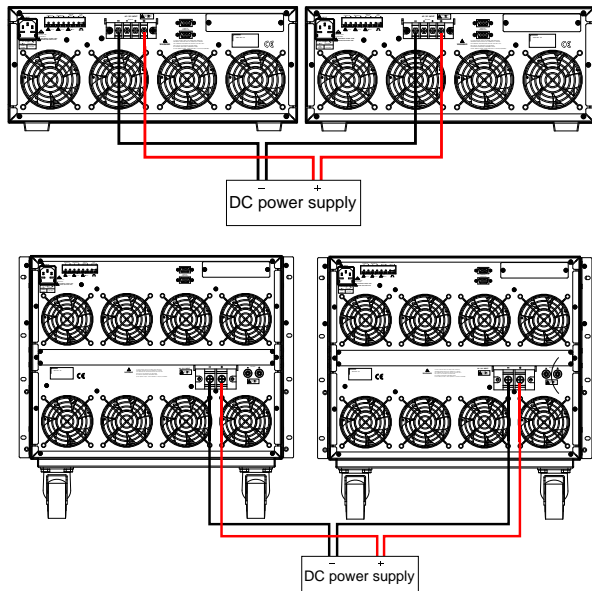



Note

- The electronic load only may carry on the parallel operation under the fixed electric current pattern.
- The electronic load do not use under series connection.

Inrush Current

Supporting the capacitive load of the power supply at startup and the sudden load access test during operation to verify the current when the appliance is turned on and when the appliance is suddenly connected, Is the Inverter output voltage transient response stable, as shown in figure a and b.

Fig. a Inrush Current test at power on

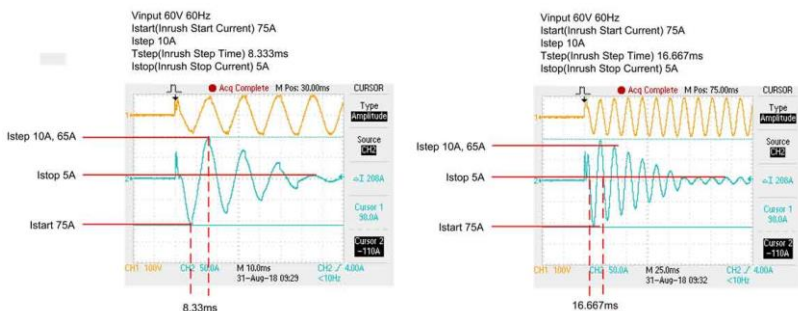
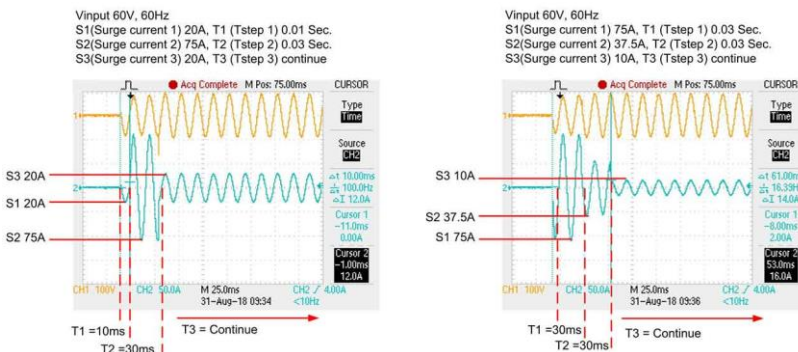

Fig. b Surge Current test when the appliance is connected



MODEL	AEL-5002-350-18.75	AEL-5003-350-28	AEL-5004-350-37.5
Programmable Inrush current simulation: Istart - Istop / Tstep			
Istart, Inrush Start Current	0~37.5A	0~56A	0~75A
Inrush Step time	0.1mS~100mS		
Istop, Inrush stop current	0~18.75A	0~28A	0~37.5A
Programmable Surge current simulation: S1/T1 - S2/T2 - S3/T3			

S1 and S2 Current	0~37.5A	0~56A	0~75A
T1 and T2 Time	0.01S~0.5Sec.		
S3 Current	0~18.75A	0~28A	0~37.5A
T3 Time	0.01S ~ 9.99Sec. or Cont.		

MODEL	AEL-5002-425-18.75	AEL-5003-425-28	AEL-5004-425-37.5
Programmable Inrush current simulation: Istart - Istop / Tsep			
Istart, Inrush Start Current	0~37.5A	0~56A	0~75A
Inrush Step time	0.1mS~100mS		
Istop, Inrush stop current	0~18.75A	0~28A	0~37.5A
Programmable Surge current simulation: S1/T1 - S2/T2 - S3/T3			
S1 and S2 Current	0~37.5A	0~56A	0~75A
T1 and T2 Time	0.01S~0.5Sec.		
S3 Current	0~18.75A	0~28A	0~37.5A
T3 Time	0.01S ~ 9.99Sec. or Cont.		

MODEL	AEL-5006-350-56	AEL-5008-350-75	AEL-5012-350-112.5
Programmable Inrush current simulation: Istart - Istop / Tsep			
Istart, Inrush Start Current	0~112A	0~150A	0~225A
Inrush Step time	0.1mS~100mS		
Istop, Inrush stop current	0~56A	0~75A	0~112.5A
Programmable Surge current simulation: S1/T1 - S2/T2 - S3/T3			
S1 and S2 Current	0~112A	0~150A	0~225A
T1 and T2 Time	0.01S~0.5Sec.		
S3 Current	0~56A	0~75A	0~112.5A
T3 Time	0.01S ~ 9.99Sec. or Cont.		

MODEL	AEL-5015-350-112.5	AEL-5019-350-112.5	AEL-5023-350-112.5
Programmable Inrush current simulation: Istart - Istop / Tsep			
Istart, Inrush Start Current	0~225A	0~225A	0~225A
Inrush Step time	0.1mS~100mS		
Istop, Inrush stop current	0~112.5A	0~112.5A	0~112.5A
Programmable Surge current simulation: S1/T1 - S2/T2 - S3/T3			
S1 and S2 Current	0~225A	0~225A	0~225A
T1 and T2 Time	0.01S~0.5Sec.		
S3 Current	0~112.5A	0~112.5A	0~112.5A
T3 Time	0.01S ~ 9.99Sec. or Cont.		

MODEL	AEL-5006-425-56	AEL-5008-425-75	AEL-5012-425-112.5
Programmable Inrush current simulation: Istart - Istop / Tsep			
Istart, Inrush Start Current	0~112A	0~150A	0~225A

Inrush Step time	0.1mS~100mS		
Istop, Inrush stop current	0~56A	0~75A	0~112.5A
Programmable Surge current simulation: S1/T1 - S2/T2 - S3/T3			
S1 and S2 Current	0~112A	0~150A	0~225A
T1 and T2 Time	0.01S~0.5Sec.		
S3 Current	0~56A	0~75A	0~112.5A
T3 Time	0.01S ~ 9.99Sec. or Cont.		

MODEL	AEL-5015-425-112.5	AEL-5019-425-112.5	AEL-5023-425-112.5
Programmable Inrush current simulation: Istart - Istop / Tsep			
Istart, Inrush Start Current	0~225A	0~225A	0~225A
Inrush Step time	0.1mS~100mS		
Istop, Inrush stop current	0~112.5A	0~112.5A	0~112.5A
Programmable Surge current simulation: S1/T1 - S2/T2 - S3/T3			
S1 and S2 Current	0~225A	0~225A	0~225A
T1 and T2 Time	0.01S~0.5Sec.		
S3 Current	0~112.5A	0~112.5A	0~112.5A
T3 Time	0.01S ~ 9.99Sec. or Cont.		

MODEL	AEL-5003-480-18.75	AEL-5004-480-28
Programmable Inrush current simulation: Istart - Istop / Tsep		
Istart, Inrush Start Current	0~37.5A	0~56A
Inrush Step time	0.1mS~100mS	
Istop, Inrush stop current	0~18.75A	0~28A
Programmable Surge current simulation: S1/T1 - S2/T2 - S3/T3		
S1 and S2 Current	0~37.5A	0~56A
T1 and T2 Time	0.01S~0.5Sec.	
S3 Current	0~18.75A	0~28A
T3 Time	0.01S ~ 9.99Sec. or Cont.	

Power Supply OCP testing

OCP Manual control

1. Press Limit Key function to setting I_Hi 8A.



2. Press Limit Key function to setting I_Lo 0A.



3. Setting OCP test, press OCP key to the next step.



4. Setting start load current 0A, press OCP key to the next step.



5. Setting stop load current 0.01A, press OCP key to the next step.

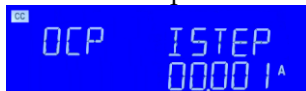

6. Setting stop load current 5A, press OCP key to the next step.



7. Setting OCP VTH 5.00V, press OCP key to the next step.
-



8. Press START/STOP test key.



9. The UUT's output voltage drop-out lower than the threshold voltage (V-th setting), and the OCP trip point is between I_Hi and I_Lo limitation, then right upper 5 digits LCD display will shows "PASS", otherwise shows "FAIL".



OCP Remote control

- REMOTE (Set Remote)
- TCONFIG OCP (Set OCP test)
- OCP:START 0.1 (Set start load current 0.1A)
- OCP:STEP 0.01 (Set step load current 0.01A)
- OCP:STOP 2 (Set stop load current 2A)
- VTH 3.0 (Set OCP VTH 3.0V)
- IL 0 (Set current low limit 0A)
- IH 2 (Set current high limit 2A)
- NGENABLE ON (Set NG Enable ON)

START	(Start OCP testing)
TESTING?	(Ask Testing? 1: Testing, 0: Testing End)
NG?	(Ask PASS/FAIL?, 0: PASS, 1: FAIL)
OCP?	(Ask OCP current value)
STOP	(Stop OCP testing)

Power Supply OPP testing

OPP Manual
control

1. Press Limit Key function to setting W_Hi
30.00W.



2. Press Limit Key function to setting W_Lo 0W.



3. Setting OPP test, press OPP key to the next
step.



4. Setting start load current 0W, press OPP key to
the next step.



5. Setting step load current 5W, press OPP key to
the next step.



6. Setting stop load current 100W, press OPP key
to the next step.



7. Setting OPP VTH 5.00V, press OPP key to the

next step.



8. Press START/STOP test key.

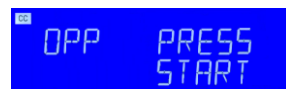

9. The UUT's output voltage drop-out lower than the threshold voltage (V-th setting), and the OPP trip point is between W_Hi and W_Lo limitation, then Right upper 5 digits LCD display will shows "PASS", otherwise shows "FAIL".



OPP Remote control

- REMOTE (Set Remote)
- TCONFIG OPP (Set OPP test)
- OPP:START 3 (Set start load watt 3W)
- OPP:STEP 1 (Set step load watt 1W)
- OPP:STOP 5 (Set stop load watt 5W)

VTH 3.0	(Set OPP VTH 3.0V)
WL 0	(Set watt low limit 0W)
WH 5	(Set watt high limit 5W)
NGENABLE ON	(Set NG Enable ON)
START	(Start OPP testing)
TESTING?	(Ask Testing? 1: Testing, 0: Testing End)
NG?	(Ask PASS/FAIL?, 0: PASS, 1 : FAIL)
OPP?	(Ask OPP watt value)
STOP	(Stop OPP testing)

SHORT testing

SHORT Manual control

1. Setting SHORT test, press Short key to the next step.

A blue LCD display with white text. The text is arranged in three lines: "SHORT" on the top line, "PRESS" on the middle line, and "START" on the bottom line. A small "CO" icon is visible in the top left corner.

2. Press UP key, setting Short time to 10000ms, press Short key to the next Step.

A blue LCD display with white text. The text is arranged in three lines: "SHORT" on the top line, "TIME" on the middle line, and "10000 ms" on the bottom line. A small "CO" icon is visible in the top left corner.

3. Press down key, setting V-Hi voltage to 6.00V, press Short key to the next Step.

A blue LCD display with white text. The text is arranged in three lines: "SHORT" on the top line, "V HI" on the middle line, and "006.00V" on the bottom line. A small "CO" icon is visible in the top left corner.

4. Press down key, setting V-Lo voltage to 0V, press Short key to the next step.

A blue LCD display with white text. The text is arranged in three lines: "SHORT" on the top line, "V LO" on the middle line, and "000.00V" on the bottom line. A small "CO" icon is visible in the top left corner.

5. Press START/STOP test key.

A blue LCD display with white text. The text is arranged in three lines: "SHORT" on the top line, "PRESS" on the middle line, and "START" on the bottom line. A small "CO" icon is visible in the top left corner.

6. Short test finish, the UUT's drop voltage is between V_Hi and V_Lo limitation, then right upper 5 digits LCD display will shows "PASS"
-



7. The UUT's not drop voltage is between V_Hi and V_Lo limitation, LCD display will shows FAIL.



SHORT Remote control

REMOTE	(Set Remote)
TCONFIG SHORT	(Set SHORT test)
STIME 1	(Set short time 1ms)
START	(Start SHORT testing)
TESTING?	(Ask Testing? 1: Testing, 0: Testing End)
STOP	(Stop SHORT testing)

BW Setting

Background

In order to match the bandwidth of different UUTs, the AEL-5000 series electronic load is designed with a settable bandwidth function. The setting range is 0 ~ 15, where 0 is the slowest and 15 is the fastest. When the bandwidth of the UUT does not match the bandwidth of the electronic load, there will be oscillations.

Please adjust the BW setting value appropriately to meet the UUT response speed.

Vin=110V/60Hz;
SET LIN 20A
BW=15

CH1=Vinput ;
CH2=Current



Vin=110V/60Hz ;
SET LIN 20A
BW=13

CH1=Vinput ;
CH2=Current

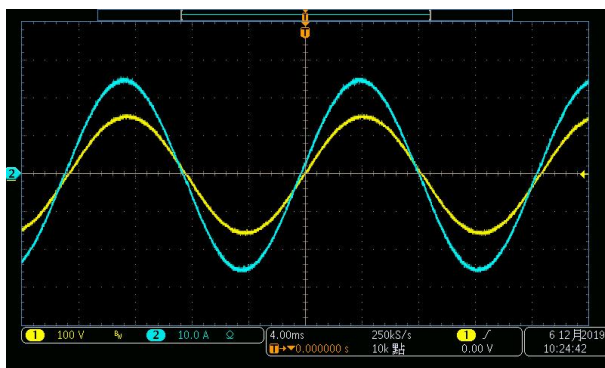

Special waveform applications

Background

The simulated UPS or the DUT whose load current will alternate on / off, is designed to have a waveform of 1ms ON and 1ms OFF at 50Hz or 60Hz. The setting method is in the constant current mode. After pressing the CF key, enter 5.1 or 5.2 From the number keys, and then press "Enter" to set. When the setting is completed, the frequency will be set to the corresponding value simultaneously.

CF = 5.1: Frequency 60Hz, 1ms ON / 1ms OFF.

CF = 5.2: Frequency 50Hz, 1ms ON / 1ms OFF.

Vin=110V/60Hz;
SET CC 5A
CF=5.1

CH1=Vininput;
CH2=Current

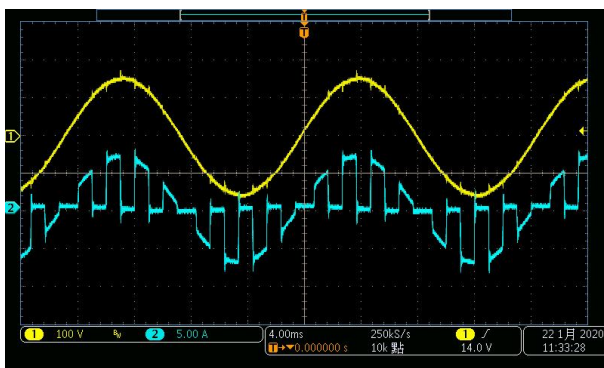

Vin=110V/50Hz;
SET CC 5A
CF=5.2

CH1=Vininput;
CH2=Current

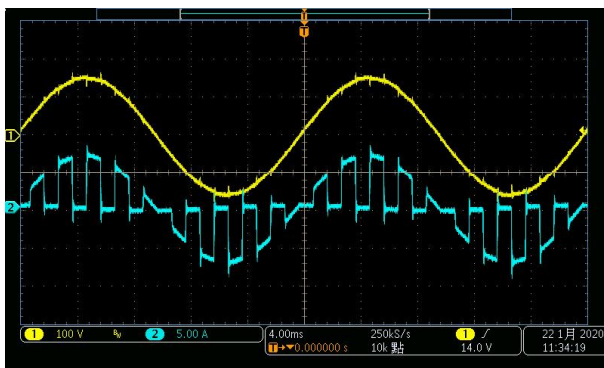

APPENDIX

Replacing the Fuse.....	249
AEL-5000 Default Settings	251
AEL-5000 Dimensions	255
AEL-5002-XXX-XX.....	255
AEL-5006-XXX-XX.....	255
AEL-5012-XXX-XX.....	256
AEL-5019-XXX-XX.....	257
AEL-5023-XXX-XX.....	258
AEL-5000 series Specifications.....	259
AEL-5002-350-18.75, AEL-5003-350-28, AEL-5004-350-37.5	259
AEL-5002-425-18.75, AEL-5003-425-28, AEL-5004-425-37.5	262
AEL-5006-350-56, AEL-5008-350-75, AEL-5012-350-112.5	265
AEL-5015-350-112.5, AEL-5019-350-112.5, AEL-5023-350-112.5	269
AEL-5006-425-56, AEL-5008-425-75, AEL-5012-425-112.5	272
AEL-5015-425-112.5, AEL-5019-425-112.5, AEL-5023-425-112.5	275
AEL-5003-480-18.75, AEL-5004-480-28	278
Certificate Of Compliance	282
GPIB programming Example.....	283
BASICA Example Program	285
AEL-5000 Series USB Instruction	287
AEL-5000 series Auto-Sequence function provide EDIT, ENTER, EXIT, TEST and STORE 5 keys operation	289
AEL-5000 Series LAN Instruction	294

Replacing the Fuse

Background This product has the power fuse, and exchanges it according to the following procedure.



Caution

Never fail to turn off the power of this product, and disconnect the plug of the AC Power cable.

Warning

To avoid the fire or electronic shock, the Fuse that will be used in the product should have the safety standard in the area of the region you use. Any use of improper Fuse or shorting the Fuse holder would be extremely dangerous and would be strictly prohibited.

Before exchanging the Fuse, if there are abnormal odor or abnormal noise

Please stop using immediately and ask for the repair.

Procedure

1. Check the rating of the line fuse and replace it with the correct fuse if necessary.
100V~240V

Model	Fuse spec
AEL-5023-350-112.5 AEL-5023-425-112.5	T10A/250V(5*20mm)
AEL-5019-350-112.5 AEL-5019-425-112.5	T8A/250V(5*20mm)
AEL-5015-350-112.5 AEL-5015-425-112.5	T6A/250V(5*20mm)
AEL-5012-350-112.5 AEL-5012-425-112.5	T4A/250V(5*20mm)
AEL-5008-350-75 AEL-5008-425-75 AEL-5006-350-56	T3A/250V(5*20mm)

AEL-5006-425-56

AEL-5002-350-18.75	T2A/250V(5*20mm)
AEL-5002-450-18.75	
AEL-5003-480-18.75	
AEL-5003-350-28	
AEL-5003-425-28	
AEL-5004-480-28	
AEL-5004-350-27.5	
AEL-5004-425-37.5	

2. The AC line fuse is located below the AC line receptacle see Fig 2-2. Use a small screwdriver to extract the fuse holder, to change a new one. Change an appropriate specifications fuse
3. Reinstall fuse holder and connect the power cord.

AEL-5000 series fuse holder

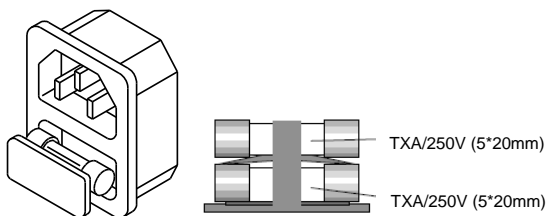

AEL-5000 Default Settings

The following default settings are the factory configuration settings for the load.

Model	AEL-5002-350-18.75	AEL-5003-350-28	AEL-5004-350-37.5
	AEL-5002-425-18.75	AEL-5003-425-28	AEL-5004-425-37.5
Item	Initial value		
CC A+Preset	0.000A	0.000A	0.000A
CC B+Preset	0.000A	0.000A	0.000A
LIN A+Preset	0.000A	0.000A	0.000A
LIN B+Preset	0.000A	0.000A	0.000A
CR A+Preset	64000Ω	42666Ω	32000Ω
CR B+Preset	64000Ω	42666Ω	32000Ω
CP A+Preset	0.0W	0.0W	0.0W
CP B+Preset	0.0W	0.0W	0.0W
CV A+Preset	500.00V	500.00V	500.00V
CV B+Preset	500.00V	500.00V	500.00V

Model	AEL-5006-350-56	AEL-5008-350-75	AEL-5012-350-112.5
	AEL-5006-425-56	AEL-5008-425-75	AEL-5012-425-112.5
Item	Initial value		
CC A+Preset	0.000A	0.000A	0.000A
CC B+Preset	0.000A	0.000A	0.000A
LIN A+Preset	0.000A	0.000A	0.000A
LIN B+Preset	0.000A	0.000A	0.000A
CR A+Preset	20000Ω	16000Ω	10666Ω
CR B+Preset	20000Ω	16000Ω	10666Ω
CP A+Preset	0.0W	0.0W	0.0W
CP B+Preset	0.0W	0.0W	0.0W
CV A+Preset	500.00V	500.00V	500.00V
CV B+Preset	500.00V	500.00V	500.00V

Model	AEL-5015-350-112.5	AEL-5019-350-112.5	AEL-5023-350-112.5
	AEL-5015-425-112.5	AEL-5019-425-112.5	AEL-5023-425-112.5
Item	Initial value		
CC A+Preset	0.000A	0.000A	0.000A
CC B+Preset	0.000A	0.000A	0.000A
LIN A+Preset	0.000A	0.000A	0.000A

LIN B+Preset	0.000A	0.000A	0.000A
CR A+Preset	10666Ω	10666Ω	10666Ω
CR B+Preset	10666Ω	10666Ω	10666Ω
CP A+Preset	0.0W	0.0W	0.0W
CP B+Preset	0.0W	0.0W	0.0W
CV A+Preset	500.00V	500.00V	500.00V
CV B+Preset	500.00V	500.00V	500.00V

Model	AEL-5003-480-18.75	AEL-5004-480-28
Item	Initial value	
CC A+Preset	0.000A	0.000A
CC B+Preset	0.000A	0.000A
LIN A+Preset	0.000A	0.000A
LIN B+Preset	0.000A	0.000A
CR A+Preset	80000Ω	50000Ω
CR B+Preset	80000Ω	500000Ω
CP A+Preset	0.0W	0.0W
CP B+Preset	0.0W	0.0W
CV A+Preset	500.00V	500.00V
CV B+Preset	500.00V	500.00V

Model	AEL-5002-350-18.75	AEL-5003-350-28	AEL-5004-350-37.5
Item	AEL-5002-425-18.75	AEL-5003-425-28	AEL-5004-428-37.5
Item	Initial value for Limit		
V_Hi	600.00V	600.00V	600.00V
V_Lo	0.00V	0.00V	0.00V
I_Hi	20.000A	30.000A	40.000A
I_Lo	0.000A	0.000A	0.000A
W_Hi	2000.0W	3000.0W	4000.0W
W_Lo	0.0W	0.0W	0.0W
VA_Hi	2000.0VA	3000.0VA	4000.0VA
VA_Lo	0.0VA	0.0VA	0.0VA
OPL	1968.75W	2940.0W	3937.5W
OCL	19.687A	29.400A	39.375A

Model	AEL-5006-350-56	AEL-5008-350-75	AEL-5012-350-112.5
Item	AEL-5006-425-56	AEL-5008-425-75	AEL-5012-425-112.5
Item	Initial value for Limit		
V_Hi	600.00V	600.00V	600.00V

V_Lo	0.00V	0.00V	0.00V
I_Hi	115.00A	80.000A	115.00A
I_Lo	0.000A	0.000A	0.000A
W_Hi	6000W	8000.0W	11500W
W_Lo	0.0W	0.0W	0.0W
VA_Hi	6000VA	8000.0VA	11500VA
VA_Lo	0.0VA	0.0VA	0.0VA
OPL	5880W	7875W	11812W
OCL	58.8A	78.75A	118.12A

Model	AEL-5015-350-112.5	AEL-5019-350-112.5	AEL-5023-350-112.5
Model	AEL-5015-425-112.5	AEL-5019-425-112.5	AEL-5023-425-112.5
Item	Initial value for Limit		
V_Hi	600.00V	600.00V	600.00V
V_Lo	0.00V	0.00V	0.00V
I_Hi	115.00A	115.00A	115.00A
I_Lo	0.000A	0.000A	0.000A
W_Hi	15500W	19000W	23000W
W_Lo	0.0W	0.0W	0.0W
VA_Hi	15500VA	19000VA	23000VA
VA_Lo	0.0VA	0.0VA	0.0VA
OPL	15750W	19687W	23625W
OCL	118.12A	118.12A	118.12A

Model	AEL-5003-480-18.75	AEL-5004-480-18.75
Item	Initial value for Limit	
V_Hi	750.00V	750.00V
V_Lo	0.00V	0.00V
I_Hi	20.000A	30.000A
I_Lo	0.000A	0.000A
W_Hi	3000.0W	4000.0W
W_Lo	0.0W	0.0W
VA_Hi	2000.0VA	4000.0VA
VA_Lo	0.0VA	0.0VA
OPL	2940.0W	3937.5W
OCL	19.687A	29.400A

Model	For all models of AEL-5000 series
Item	Initial value for Config
EXTIN	OFF
SYNC	OFF
LD ON	0
LDOFF	0
BW	AUTO
AVG	1
CPRSP	0
CYCLE	1

AEL-5000 Dimensions

AEL-5002-XXX-XX

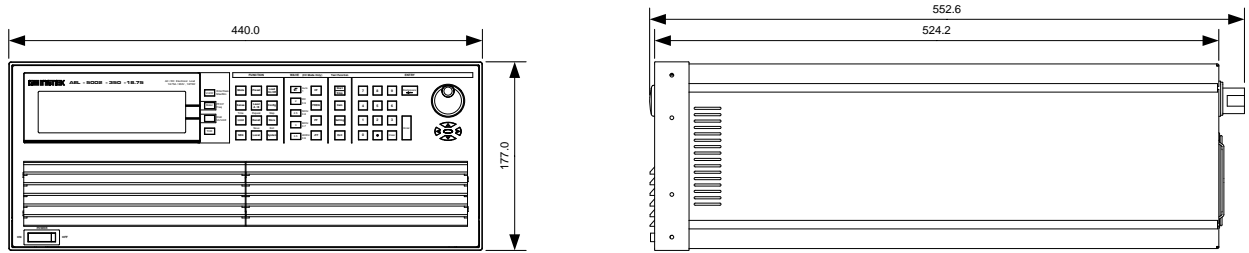

AEL-5006-XXX-XX

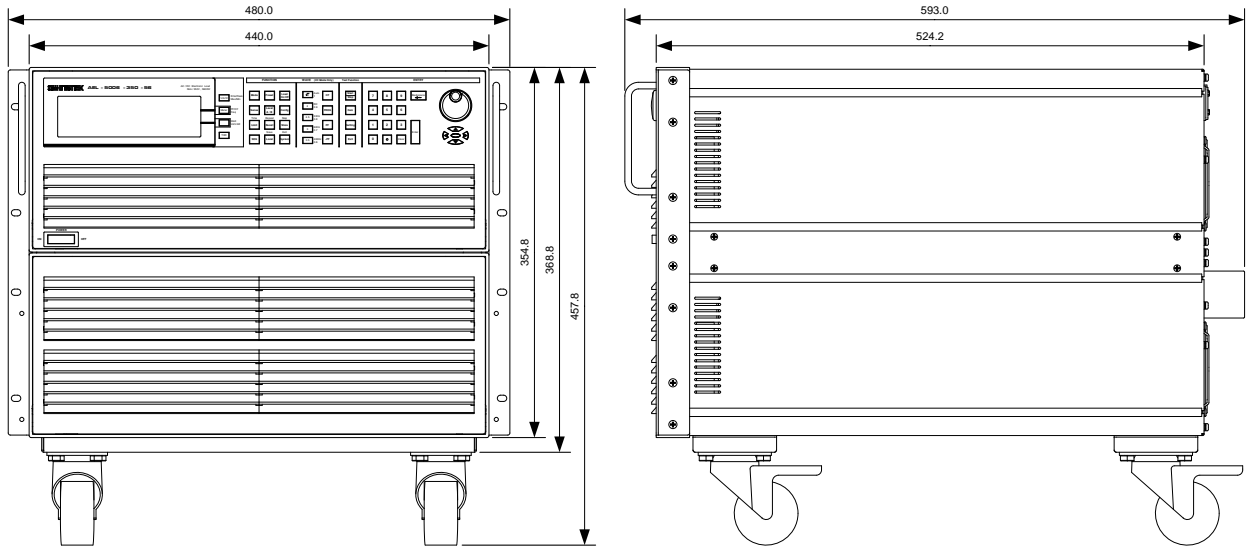

AEL-5012-XXX-XX

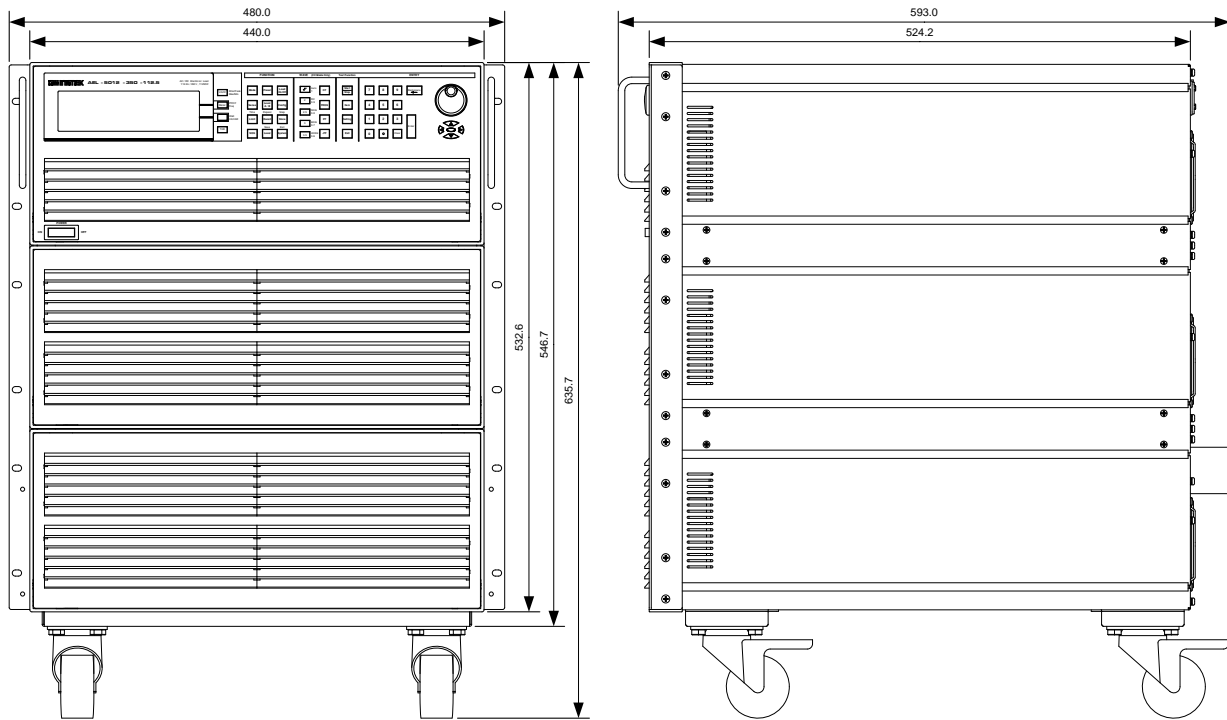

AEL-5019-XXX-XX

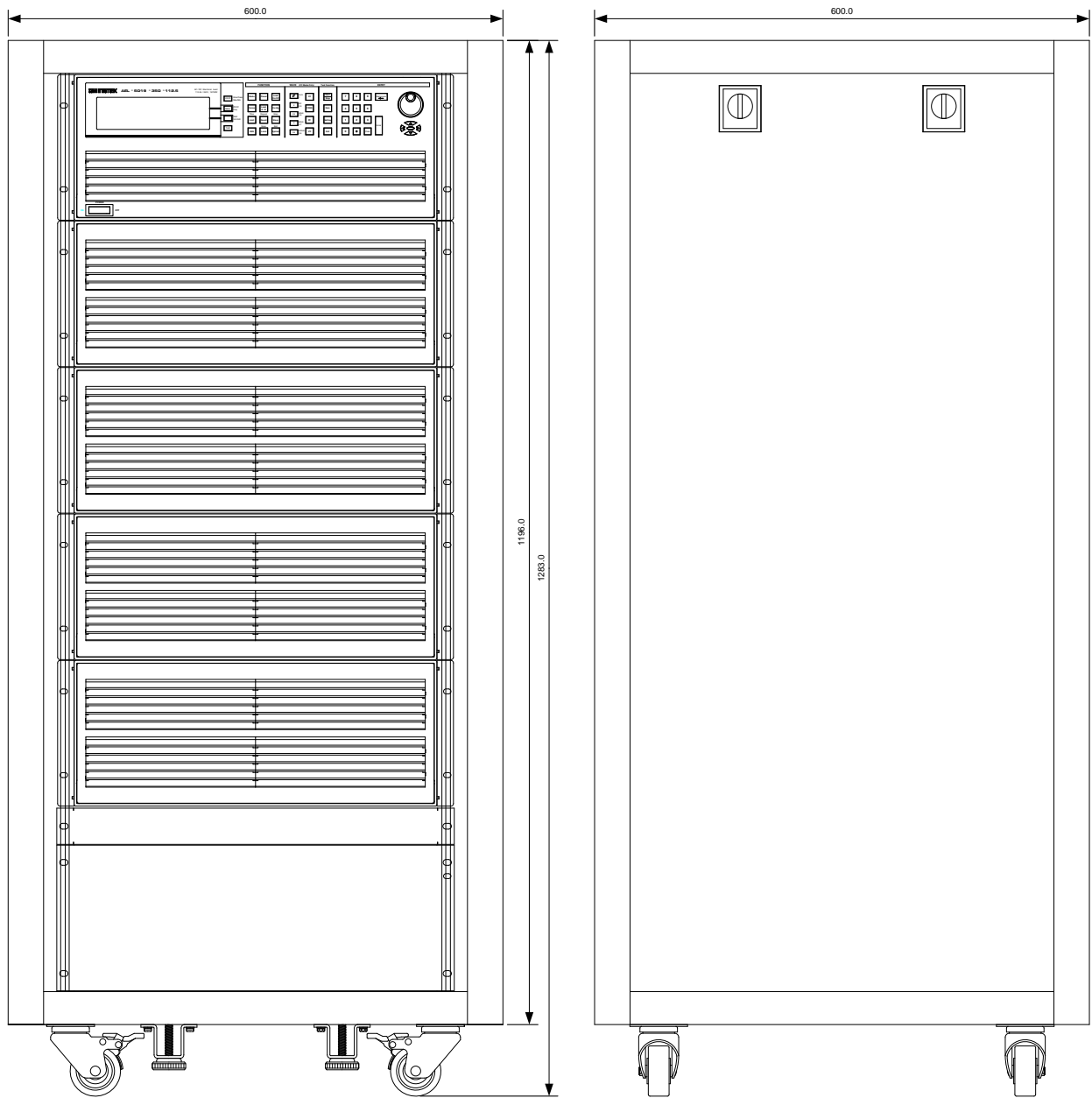

AEL-5023-XXX-XX

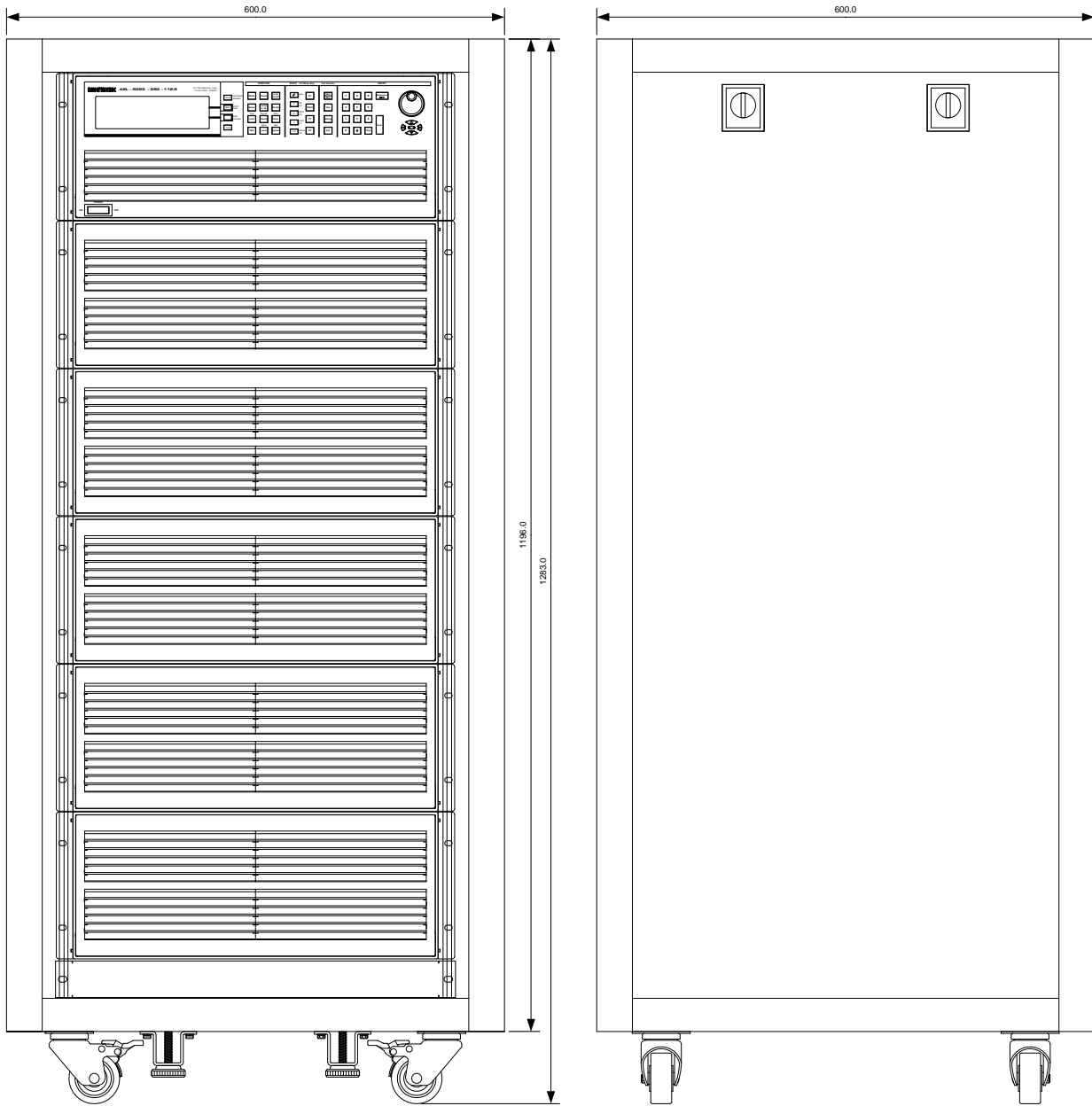

AEL-5000 series Specifications

The specifications apply when the AEL-5000 is powered on for at least 30 minutes. Note that the high frequency and high voltage options are listed as separate specifications.

AEL-5002-350-18.75, AEL-5003-350-28, AEL-5004-350-37.5

Model	AEL-5002-350-18.75	AEL-5003-350-28	AEL-5004-350-37.5
Power (W)	1875W	2800W	3750W
Current(Ampere)	18.75Arms or Adc/ 56.25Apeak	28Arms or Adc/ 84Apeak	37.5Arms or Adc/ 112.5Apeak
Voltage(Volt)	50 ~ 350Vrms / 5 ~ 500Vdc		
Slew Rate(DC)	50 μ s		
Frequency Range	DC, 40 ~ 440Hz(CC, CP Mode), DC ~ 440Hz(LIN, CR, CV Mode)		
Protections			
Over Power Protection	\approx 1968.75Wrms or Programmable	\approx 2940Wrms or Programmable	\approx 3937.5Wrms or Programmable
Over Current Protection	\approx 19.687 Arms or Programmable	\approx 29.4 Arms or Programmable	\approx 39.375 Arms, or Programmable
Over Voltage Protection	\approx 367.5Vrms/525Vdc		
Over Temp. Protection	Yes		
Operation Model			
Constant Current Mode for Sine-Wave			
Range	0~18.75A	0~28A	0~37.5A
Resolution	0.3125mA/16bits	0.5mA/16bits	0.625mA/16bits
Accuracy	\pm (0.1% of setting + 0.2% of range)@50/60Hz, \pm 0.5% of (setting + range)@DC and 400Hz		
Linear Constant Current Mode for Sine-Wave, Square-Wave or Quasi-Square Wave, PWM Wave			
Range	0~18.75A	0~28A	0~37.5A
Resolution	0.3125mA/16bits	0.5mA/16bits	0.625mA/16bits
Accuracy	\pm (0.1% of setting + 0.2% of range)@50/60Hz, \pm 0.5% of (setting + range)@DC and 400Hz		
Constant Resistance Mode			
Range	3.2 Ω ~ 64k Ω	2.0 Ω ~ 40k Ω	1.6 Ω ~ 32k Ω
Resolution ^{*1}	0.0052083mS/16bits	0.0083333mS/16bits	0.010416mS/16bits
Accuracy	\pm 0.2% of (setting + range)@50/60Hz, \pm (0.5% of setting + 2% of range)@DC and 400Hz		
Constant Voltage Mode			
Range	50~350Vrms / 500Vdc		
Resolution	0.01V		
Accuracy	\pm (0.1 of setting + 0.1% of range)		

Constant Power Mode				
Range	1875W	2800W	3750W	
Resolution	0.1W			
Accuracy ^{*4}	±0.5% of (setting + range) @ 50/60Hz, ±2% of (setting + range) @ other frequency			
CREST factor (CC & CP MODE ONLY)				
Range	$\sqrt{2}-5$			
Resolution	0.1			
Accuracy	(0.5% / Irms) + 1% F.S.			
Power factor (CC & CP MODE ONLY)				
Range	0~1 Lag or Lead			
Resolution	0.01			
Accuracy	1% F.S.			
TEST MODE				
UPS Efficient Measurement	Non-Linear Mode			
Operating Frequency	Auto ; 40~440Hz			
Current Range	0~18.75A	0~28A	0~37.5A	
PF Range	0~1			
Measuring Efficiency for PV System, Power Conditioners for THD 80%	Resistive + Non-Linear Mode			
Operating Frequency	Auto ; 40~440Hz			
Current Range	0~18.75A	0~28A	0~37.5A	
Resistive Range	3.2Ω ~ 64kΩ	2.0Ω ~ 40kΩ	1.6Ω ~ 32kΩ	
UPS Back-Up function(CC,LIN,CR,CP)				
UVP (VTH)	50~350Vrms / 500Vdc			
UPS Back-Up Time	1~99999 Sec. (>27H)			
Battery Discharge function(CC,LIN,CR,CP)				
UVP (VTH)	50~350Vrms / 500Vdc			
Battery Discharge Time	1~99999 Sec. (>27H)			
UPS Transfer Time				
Current Range	0~18.75A	0~28A	0~37.5A	
UVP (VTH)	2.5V			
Time range	0.15mS~999.99mS			
Fuse Test mode				
Max. current	Turbo OFF(CC1~3)	18.75Arms	28.0Arms	37.5Arms
	Turbo ON CC3 CC1~2	37.5Arms (x2) ^{*3}	56.0Arms(x2) ^{*3}	75.0Arms(x2) ^{*3}
Trip & non-trip time	Turbo OFF(TIME1~3)	0.01~333.33 sec.		
	Turbo ON	TIME 1~2	0.01~0.50 sec.	
		TIME3	0.01~600.00 sec.	
OFF TIME	0.01~9999.9 sec.			
Meas. Accuracy	±0.003 sec.			
Repeat Cycle	0~99999			

Short/OPP/OCF Test Function				
Short Time	Turbo OFF	0.1S ~ 10Sec. or Cont.		
	Turbo ON	0.1S ~ 1Sec		
OPP/OCF Step Time	Turbo OFF	100ms		
	Turbo ON	100ms, up to 10 Steps		
OCF Istop	Turbo OFF	18.75Arms	28.0Arms	37.5Arms
	Turbo ON	37.5Arms	56.0Arms	75.0Arms
OPP Pstop	Turbo OFF	1875W	2800W	3750W
	Turbo ON	3750W	5600W	7500W
Programmable Inrush current simulation: Istart - Istop/ Tsep				
Istart, Inrush Start Current	0~37.5A	0~56A	0~75A	
Inrush Step time	0.1mS~100mS			
Istop, Inrush stop current	0~18.75A	0~28A	0~37.5A	
Programmable Surge current simulation: S1/T1 - S2/T2 - S3/T3				
S1 and S2 Current	0~37.5A	0~56A	0~75A	
T1 and T2 Time	0.01S ~ 0.5Sec.			
S3 Current	0~18.75A	0~28A	0~37.5A	
T3 Time	0.01S~9.99Sec. Or Cont.			
MEASUREMENTS				
VOLTAGE READBACK V METER				
Range	500V			
Resolution	0.01V			
Accuracy	±0.05% of (reading + range)			
Parameter	Vrms, V Max/Min, ±Vpk			
CURRENT READBACK A METER				
Range	9.375Arms/18.75Arms	14Arms/28Arms	18.75Arms/37.5Arms	
Resolution	0.2mA/0.4mA	0.3mA/0.6mA	0.4mA/0.8mA	
Accuracy	±0.05% of (reading + range)@ 50/60Hz, ±0.2% of (reading + range)			
Parameter	Irms, I Max/Min, ±Ipk			
WATT READBACK W METER				
Range	1875W	2800W	3750W	
Resolution	0.03125W	0.05W	0.0625W	
Accuracy*4	±0.5% of (reading + range)@50/60Hz, ±2% of (reading + range)@ other frequency			
VA METER	Vrms x Arms correspond to Vrms and Arms			
Power Factor METER				
Range	±0.000~1.000			
Accuracy	±(0.002±(0.001/PF)*F)			
Frequency METER(Hz)				
Range	DC,40~440Hz			
Accuracy	0.1%			
Other Parameter METER				
VA, VAR, CF_I, Ipeak, Imax., Imin. Vmax., Vmin., IHD, VHD, ITHD, VTHD				

OTHERS			
Start up loading	Yes, Power on loading during Inverter / UPS start up		
Load ON / OFF Angle	0 ~ 359 degree can be programmed for the angle of load ON and load OFF loading		
Half cycle and SCR/TRIAC loading	Positive or Negative half cycle, 90° Trailing edge or Leading edge current waveform can be programmed		
Master/Slave (3 phase or Parallel application)	Yes, 1 master and up to 7 slave unit		
External programming input	F.S / 10Vdc, Resolution 0.1V		
External SYNC input	TTL		
Vmonitor (Isolated)	±500V / ±10V		
Imonitor (Isolated)	±56.25Apk / ±10Vpk ±84Apk / ±10Vpk ±112.5Apk / ±10Vpk		
Interface (OPTION)	GPIB; RS-232; LAN; USB		
MAX. Power consumption	150VA		
Operation Temperature *2	0 ~ 40°C		
Current of input impedance (mA) @ 50/60Hz ; @400Hz	~V*0.3 ; ~V*2.2	~V*0.45 ; ~V*3.3	~V*0.6 ; ~V*4.4
Dimension(H x W x D)	177 x 440 x 552.6mm		
Weight	21.5Kg	27.5Kg	33.5Kg

AEL-5002-425-18.75, AEL-5003-425-28, AEL-5004-425-37.5

MODEL	AEL-5002-425-18.75	AEL-5003-425-28	AEL-5004-425-37.5
Power (W)	1875W	2800W	3750W
Current(Ampere)	18.75Arms or Adc/ 56.25Apeak	28Arms or Adc/ 84Apeak	37.5Arms or Adc/ 112.5Apeak
Voltage(Volt)	50 ~ 425Vrms / 5 ~ 600Vdc		
Slew Rate(DC)	50µs		
Frequency Range	DC, 40 ~ 440Hz(CC, CP Mode), DC ~ 440Hz(LIN, CR, CV Mode)		
PROTECTIONS			
Over Power Protection	≅ 1968.75Wrms or Programmable	≅ 2940Wrms or Programmable	≅ 3937.5Wrms or Programmable
Over Current Protection	≅ 19.687Arms or Programmable	≅ 29.4Arms or Programmable	≅ 39.375Arms, or Programmable
Over Voltage Protection	≅ 446.25Vrms/630Vdc		
Over Temp. Protection	Yes		
OPERATION MODE			
Constant Current Mode for Sine-Wave			
Range	0~18.75A	0~28A	0~37.5A
Resolution	0.3125mA/16bits	0.5mA/16bits	0.625mA/16bits
Accuracy	±(0.1% of setting + 0.2% of range)@50/60Hz, ±0.5% of (setting + range)@DC and 400Hz		

Linear Constant Current Mode for Sine-Wave, Square-Wave or Quasi-Square Wave, PWM Wave			
Range	0~18.75A	0~28A	0~37.5A
Resolution	0.3125mA/16bits	0.5mA/16bits	0.625mA/16bits
Accuracy	±(0.1% of setting + 0.2% of range) @50/60Hz, ±0.5% of (setting + range) @DC and 400Hz		
Constant Resistance Mode			
Range	3.2Ω ~ 64kΩ	2.0Ω ~ 40kΩ	1.6Ω ~ 32kΩ
Resolution*1	0.0052083mS/16bits	0.0083333mS/16bits	0.010416mS/16bits
Accuracy	±0.2% of (setting + range) @50/60Hz, ±(0.5% of setting + 2% of range) @DC and 400Hz		
Constant Voltage Mode			
Range	50~425Vrms /600Vdc		
Resolution	0.1V		
Accuracy	±(0.1 of setting + 0.1%of range)		
Constant Power Mode			
Range	1875W	2800W	3750W
Resolution	0.1W	0.1W	0.1W
Accuracy*4	±0.5% of (setting + range) @ 50/60Hz, ±2% of (setting + range) @ other frequency		
CREST factor (CC & CP MODE ONLY)			
Range	$\sqrt{2}$ -5		
Resolution	0.1		
Accuracy	(0.5% / Irms) + 1% F.S.		
Power factor (CC & CP MODE ONLY)			
Range	0~1 Lag or Lead		
Resolution	0.01		
Accuracy	1% F.S.		
Test Mode			
UPS Efficient Measurement	Non-Linear Mode		
Operating Frequency	Auto ; 40~440Hz		
Current Range	0~18.75A	0~28A	0~37.5A
PF Range	0~1		
Measuring Efficiency for PV System, Power Conditioners for THD 80%	Resistive + Non-Linear Mode		
Operating Frequency	Auto ; 40~440Hz		
Current Range	0~18.75A	0~28A	0~37.5A
Resistive Range	3.2Ω ~ 64kΩ	2.0Ω ~ 40kΩ	1.6Ω ~ 32kΩ
UPS Back-Up function(CC,LIN,CR,CP)			
UVP (VTH)	50~425Vrms / 600Vdc		
UPS Back-Up Time	1~99999 Sec. (>27H)		
Battery Discharge function(CC,LIN,CR,CP)			
UVP (VTH)	50~425Vrms / 600Vdc		
Battery Discharge Time	1~99999 Sec. (>27H)		

UPS Transfer Time				
Current Range	0~18.75A	0~28A	0~37.5A	
UVP (VTH)	2.5V			
Time range	0.15mS~999.99mS			
Fuse Test mode				
Max. current	Turbo OFF(CC1~3)	18.75Arms	28.0Arms	37.5Arms
	Turbo ON	CC3	37.5Arms (x2)*3	56.0Arms(x2)*3
Trip & non-trip time	Turbo OFF(TIME1~3)	0.01~333.33 sec.		
	Turbo ON	TIME 1~2	0.01~0.50 sec.	
		TIME3	0.01~600.00 sec.	
OFF TIME	0.01~9999.9 sec.			
Meas. Accuracy	±0.003 sec.			
Repeat Cycle	0~99999			
Short/OPP/OCF Test Function				
Short Time	Turbo OFF	0.1S ~ 10Sec. or Cont.		
	Turbo ON	0.1S ~ 1Sec		
OPP/OCF Step	Turbo OFF	100ms		
Time	Turbo ON	100ms, up to 10 Steps		
OCF Istop	Turbo OFF	18.75Arms	28.0Arms	37.5Arms
	Turbo ON	37.5Arms	56.0Arms	75.0Arms
OPP Pstop	Turbo OFF	1875W	2800W	3750W
	Turbo ON	3750W	5600W	7500W
Programmable Inrush current simulation: Istart - Istop/ Tsep				
Istart, Inrush Start Current	0~37.5A	0~56A	0~75A	
Inrush Step time	0.1mS~100mS			
Istop, Inrush stop current	0~18.75A	0~28A	0~37.5A	
Programmable Surge current simulation: S1/T1 - S2/T2 - S3/T3				
S1 and S2 Current	0~37.5A	0~56A	0~75A	
T1 and T2 Time	0.01S ~ 0.5Sec.			
S3 Current	0~18.75A	0~28A	0~37.5A	
T3 Time	0.01S~9.99Sec. Or Cont.			
MEASUREMENTS				
VOLTAGE READBACK V METER				
Range	600V			
Resolution	0.01V			
Accuracy	±0.05% of (reading + range)			
Parameter	Vrms, V Max/Min, ±Vpk			
CURRENT READBACK A METER				
Range	9.375Arms/18.75Arms	14Arms/28Arms	18.75Arms/37.5Arms	
Resolution	0.2mA/0.4mA	0.3mA/0.6mA	0.4mA/0.8mA	
Accuracy	±0.05% of (reading + range)@ 50/60Hz, ±0.2% of (reading + range)@ other frequency			
Parameter	Irms, I Max/Min, ±Ipk			

WATT READBACK W METER			
Range	1875W	2800W	3750W
Resolution	0.03125W	0.05W	0.0625W
Accuracy ^{*4}	±0.5% of (reading + range)@ 50/60Hz, ±2% of (reading + range)@ other frequency		
VA METER	Vrms x Arms correspond to Vrms and Arms		
Power Factor METER			
Range	±0.000~1.000		
Accuracy	±(0.002±(0.001/PF)*F)		
Frequency METER(Hz)			
Range	DC,40~440Hz		
Accuracy	0.1%		
Other Parameter METER			
VA, VAR, CF _L , Ipeak, I _{max.} , I _{min.} , V _{max.} , V _{min.} , IHD, VHD, ITHD, VTHD			
OTHERS			
Start up loading	Yes , Power on loading during Inverter / UPS start up		
Load ON / OFF Angle	0 ~ 359 degree can be programmed for the angle of load ON and load OFF loading		
Half cycle and SCR/TRIAC loading	Positive or Negative half cycle, 90° Trailing edge or Leading edge current waveform can be programmed		
Master/Slave (3 phase or Parallel application)	Yes, 1 master and up to 7 slave unit		
External programming input	F.S / 10Vdc, Resolution 0.1V		
External SYNC input	TTL		
Vmonitor (Isolated)	±600V / ±10V		
Imonitor (Isolated)	±56.25Apk / ±10Vpk	±84Apk / ±10Vpk	±112.5Apk / ±10Vpk
Interface (OPTION)	GPIB; RS-232; LAN; USB		
MAX. Power consumption	150VA		
Operation Temperature ^{*2}	0 ~ 40°C		
Current of input impedance (mA)@ 50/60Hz ; @400Hz	~V*0.3 ; ~V*2.2	~V*0.45 ; ~V*3.3	~V*0.6 ; ~V*4.4
Dimension(H x W x D)	177 x 440 x 552.6 mm		
Weight	21.5Kg	27.5Kg	33.5Kg

AEL-5006-350-56, AEL-5008-350-75, AEL-5012-350-112.5

MODEL	AEL-5006-350-56	AEL-5008-350-75	AEL-5012-350-112.5
Power (W)	5600W	7500W	11250W
Current(Ampere)	56Arms or Adc/ 168Apeak	75Arms or Adc/ 225Apeak	112.5Arms or Adc/ 337.5Apeak
Voltage(Volt)	50 ~ 350Vrms / 5 ~ 500Vdc		
Slew Rate(DC)	50μs		
Frequency Range	DC, 40 ~ 440Hz(CC, CP Mode), DC ~ 440Hz(LIN, CR, CV Mode)		
PROTECTIONS			
Over Power Protection	≅ 5880Wrms or Programmable	≅ 7875Wrms or Programmable	≅ 11812.5Wrms or Programmable

Over Current Protection	≅ 58.8Arms, or Programmable	≅ 78.75Arms, or Programmable	≅ 118.125Arms or Programmable
Over Voltage Protection	≅ 367.5Vrms/525Vdc		
Over Temp. Protection	Yes		
OPERATION MODE			
Constant Current Mode for Sine-Wave			
Range	0~56A	0~75A	0~112.5A
Resolution	1mA/16bits	1.25mA/16bits	1.875mA/16bits
Accuracy	±(0.1% of setting + 0.2% of range)@50/60Hz, ±0.5% of (setting + range)@DC and 400Hz		
Linear Constant Current Mode for Sine-Wave, Square-Wave or Quasi-Square Wave, PWM Wave			
Range	0~56A	0~75A	0~112.5A
Resolution	1mA/16bits	1.25mA/16bits	1.875mA/16bits
Accuracy	±(0.1% of setting + 0.2% of range)@50/60Hz, ±0.5% of (setting + range)@DC and 400Hz		
Constant Resistance Mode			
Range	1Ω~ 20kΩ	0.8Ω ~ 16kΩ	0.533Ω ~10.666kΩ
Resolution ^{*1}	0.016666mS/16bits	0.020832mS/16bits	0.031248mS/16bits
Accuracy	±0.2% of (setting + range)@50/60Hz, ±(0.5% of setting + 2% of range)@DC and 400Hz		
Constant Voltage Mode			
Range	50~350Vrms / 500Vdc		
Resolution	0.1V		
Accuracy	±0.2% of (setting + range)@ 50/60Hz, ±0.4% of (setting + range)		
Constant Power Mode			
Range	5600W	7500W	11250W
Resolution	0.1W	0.1W	1W
Accuracy ^{*4}	±0.5% of (setting + range)@ 50/60Hz, ±2% of (setting + range)@ other frequency		
CREST factor (CC & CP MODE ONLY)			
Range	$\sqrt{2}$ ~5		
Resolution	0.1		
Accuracy	(0.5% / Irms) + 1% F.S.		
Power factor (CC & CP MODE ONLY)			
Range	0~1 Lag or Lead		
Resolution	0.01		
Accuracy	1% F.S.		
TEST MODE			
UPS Efficient Measurement	Non-Linear Mode		
Operating Frequency	Auto ; 40~440Hz		
Current Range	0~56A	0~75A	0~112.5A
PF Range	0~1		
Measuring Efficiency for PV System, Power Conditioners for THD 80%	Resistive + Non-Linear Mode		
Operating Frequency	Auto ; 40~440Hz		

Current Range	0~56A	0~75A	0~112.5A	
Resistive Range	1Ω ~ 20kΩ	0.8Ω~ 16kΩ	0.533Ω ~ 10.666kΩ	
UPS Back-Up function(CC,LIN,CR,CP)				
UVP (VTH)	50~350Vrms / 500Vdc			
UPS Back-Up Time	1~99999 Sec. (>27H)			
Battery Discharge function(CC,LIN,CR,CP)				
UVP (VTH)	50~350Vrms / 500Vdc			
Battery Discharge Time	1~99999 Sec. (>27H)			
UPS Transfer Time				
Current Range	0~56A	0~75A	0~112.5A	
UVP (VTH)	2.5V			
Time range	0.15mS~999.99mS			
Fuse Test mode				
Max. current	Turbo OFF(CC1~3)	75Arms	75Arms	112.5Arms
	Turbo ON CC3 CC1~2	150Arms (x2)*3	150Arms(x2)*3	225Arms(x2)*3
Trip & non-trip time	Turbo OFF(TIME1~3)	0.01~333.33 sec.		
	Turbo ON TIME1~2	0.01~0.50 sec.		
	Turbo ON TIME3	0.01~600.00 sec.		
OFF TIME	0.01~9999.9 sec.			
Meas. Accuracy	±0.003 sec.			
Repeat Cycle	0~99999			
Short/OPP/OCP Test Function				
Short Time	Turbo OFF	0.1S ~ 10Sec. or Cont.		
	Turbo ON	0.1S ~ 1Sec		
OPP/OCP Step Time	Turbo OFF	100ms		
	Turbo ON	100ms, up to 10 Steps		
OCP Istop	Turbo OFF	56Arms	75Arms	112.5Arms
	Turbo ON	112Arms	150Arms	225Arms
OPP Pstop	Turbo OFF	5600W	7500W	11250W
	Turbo ON	11200W	15000W	22500W
Programmable Inrush current simulation: Istart - Istop/ Tsep				
Istart, Inrush Start Current	0~112A	0~150A	0~225A	
Inrush Step time	0.1mS~100mS			
Istop, Inrush stop current	0~56A	0~75A	0~112.5A	
Programmable Surge current simulation: S1/T1 - S2/T2 - S3/T3				
S1 and S2 Current	0~112A	0~150A	0~225A	
T1 and T2 Time	0.01S ~ 0.5Sec.			
S3 Current	0~56A	0~75A	0~112.5A	
T3 Time	0.01S~9.99Sec. Or Cont.			
MEASUREMENTS				
VOLTAGE READBACK V METER				
Range	500V			
Resolution	0.01V			
Accuracy	±0.05% of (reading + range)			
Parameter	Vrms, V Max/Min, ±Vpk			

CURRENT READBACK A METER			
Range	28Arms/56Arms	37.5Arms/75Arms	56.25Arms/112.5Arms
Resolution	0.6mA/1.2mA	0.8mA/1.6mA	1.2mA/2.4mA
Accuracy	±0.05% of (reading + range) @ 50/60Hz, ±0.2% of (reading + range) @ other frequency		
Parameter	Irms, I Max/Min, ±IpK		
WATT READBACK W METER			
Range	5600W	7500W	11250W
Resolution	0.1W	0.125W	0.1875W
Accuracy*4	±0.5% of (reading + range) @ 50/60Hz, ±2% of (reading + range) @ other frequency		
VA METER	Vrms x Arms correspond to Vrms and Arms		
Power Factor METER			
Range	±0.000~1.000		
Accuracy	±(0.002±(0.001/PF)*F)		
Frequency METER(Hz)			
Range	DC,40~440Hz		
Accuracy	0.1%		
Other Parameter METER			
VA, VAR, CF_I, Ipeak, Imax., Imin, Vmax., Vmin., IHD, VHD, ITHD, VTHD			
OTHERS			
Start up loading	Yes , Power on loading during Inverter / UPS start up		
Load ON / OFF Angle	0 ~ 359 degree can be programmed for the angle of load ON and load OFF loading		
Half cycle and SCR/TRIAC loading	Positive or Negative half cycle, 90° Trailing edge or Leading edge current waveform can be programmed		
Master/Slave (3 phase or Parallel application)	Yes, 1 master and up to 7 slave unit		
External programming input	F.S / 10Vdc, Resolution 0.1V		
External SYNC input	TTL		
Vmonitor (Isolated)	±500V / ±10V		
Imonitor (Isolated)	±168Apk / ±10Vpk	±225Apk / ±10Vpk	±337.5Apk / ±10Vpk
Interface (OPTION)	GPIB; RS-232; LAN; USB		
MAX. Power consumption	270VA	270VA	390VA
Operation Temperature *2	0 ~ 40°C		
Current of input impedance(mA) @ 50/60Hz ; @400Hz	~V*0.9 ; ~V*6.6	~V*1.2 ; ~V*8.8	~V*1.8 ; ~V*13.2
Dimension(H x W x D)	457.8 x 480 x 593		
Weight	58 kg	70 kg	105kg

AEL-5015-350-112.5, AEL-5019-350-112.5, AEL-5023-350-112.5

MODEL	AEL-5015-350-112.5	AEL-5019-350-112.5	AEL-5023-350-112.5
Power (W)	15000W	18750W	22500W
Current(Ampere)	112.5Arms or Adc / 337.5Apeak	112.5Arms or Adc / 337.5Apeak	112.5Arms or Adc / 337.5Apeak
Voltage(Volt)	50 ~ 350Vrms / 5 ~ 500Vdc		
Slew Rate(DC)	50 μ s		
Frequency Range	DC, 40 ~ 440Hz(CC, CP Mode), DC ~ 440Hz(LIN, CR, CV Mode)		
PROTECTIONS			
Over Power Protection	\approx 11812.5Wrms or Programmable	\approx 19687.5Wrms or Programmable	\approx 23625Wrms or Programmable
Over Current Protection	\approx 118.125Arms or Programmable		
Over Voltage Protection	\approx 367.5 Vrms/525Vdc		
Over Temp. Protection	Yes		
OPERATION MODE			
Constant Current Mode for Sine-Wave			
Range	0~112.5A		
Resolution	1.875mA/16bits		
Accuracy	\pm (0.1% of setting + 0.2% of range)@50/60Hz, \pm 0.5% of (setting + range)@DC and 400Hz		
Linear Constant Current Mode for Sine-Wave, Square-Wave or Quasi-Square Wave, PWM Wave			
Range	0~112.5A		
Resolution	1.875mA/16bits		
Accuracy	\pm (0.1% of setting + 0.2% of range)@50/60Hz, \pm 0.5% of (setting + range)@DC and 400Hz		
Constant Resistance Mode			
Range	0.533 Ω ~ 0.666k Ω	0.533 Ω ~ 10.666k Ω	0.533 Ω ~ 10.666k Ω
Resolution ^{*1}	0.031248mS/16bits		
Accuracy	\pm 0.2% of (setting + range)@50/60Hz, \pm (0.5% of setting + 2% of range)@DC and 400Hz		
Constant Voltage Mode			
Range	50~350Vrms / 500Vdc		
Resolution	0.1V		
Accuracy	\pm 0.2% of (setting + range)@ 50/60Hz, \pm 0.4% of (setting + range)		
Constant Power Mode			
Range	15000 W	18750W	22500W
Resolution	1W		
Accuracy ^{*4}	\pm 0.5% of (setting + range)@ 50/60Hz, \pm 2% of (setting + range)@ other frequency		
CREST factor (CC & CP MODE ONLY)			
Range	$\sqrt{2}$ ~5		
Resolution	0.1		

Accuracy	(0.5% / Irms) + 1% F.S.	
Power factor (CC & CP MODE ONLY)		
Range	0~1 Lag or Lead	
Resolution	0.01	
Accuracy	1% F.S.	
TEST MODE		
UPS Efficient Measurement	Non-Linear Mode	
Operating Frequency	Auto ; 40~440Hz	
Current Range	0~112.5A	
PF Range	0 ~1	
Measuring Efficiency for PV System, Power Conditioners for THD 80%	Resistive + Non-Linear Mode	
Operating Frequency	Auto ; 40~440Hz	
Current Range	0~112.5A	
Resistive Range	0.533 Ω ~ 10.666K Ω	
UPS Back-Up function(CC,LIN,CR,CP)		
UVP (VTH)	50~350Vrms / 500Vdc	
UPS Back-Up Time	1~99999 Sec. (>27H)	
Battery Discharge function(CC,LIN,CR,CP)		
UVP (VTH)	50~350Vrms / 500Vdc	
Battery Discharge Time	1~99999 Sec. (>27H)	
UPS Transfer Time		
Current Range	0~112.5A	
UVP (VTH)	2.5V	
Time range	0.15mS~999.99mS	
Fuse Test mode		
Max. current	Turbo OFF(CC1~3)	112.5Arms
	Turbo ON	CC3 CC1~2 225Arms (x2)*3
Trip & non-trip time	Turbo OFF(TIME1~3)	0.01~333.33 sec.
	Turbo ON	TIME 1~2 0.01~0.50 sec. TIME3 0.01~600.00 sec.
OFF TIME	0.01~9999.9 sec.	
Meas. Accuracy	±0.003 sec.	
Repeat Cycle	0~99999	
Short/OPP/OCF Test Function		
Short Time	Turbo OFF	0.1S ~ 10Sec. or Cont.
	Turbo ON	0.1S ~ 1Sec
OPP/OCF	Turbo OFF	100ms
Step Time	Turbo ON	100ms, up to 10 Steps
OCF Istop	Turbo OFF	112.5Arms
	Turbo ON	225Arms

OPP Pstop	Turbo OFF	15000W	18750W	22500W
	Turbo ON	30000W	37500W	45000W
Programmable Inrush current simulation: Istart - Istop/ Tsep				
Istart, Inrush Start Current	0~225A			
Inrush Step time	0.1mS~100mS			
Istop, Inrush stop current	0~112.5A			
Programmable Surge current simulation: S1/T1 - S2/T2 - S3/T3				
S1 and S2 Current	0~225A			
T1 and T2 Time	0.01S ~ 0.5Sec.			
S3 Current	0~112.5A			
T3 Time	0.01S~9.99Sec. Or Cont.			
MEASUREMENTS				
VOLTAGE READBACK V METER				
Range	500V			
Resolution	0.01V			
Accuracy	±0.05% of (reading + range)			
Parameter	Vrms, V Max/Min, ±Vpk			
CURRENT READBACK A METER				
Range	56.25Arms/112.5Arms	56.25Arms/112.5Arms	56.25Arms/112.5Arms	56.25Arms/112.5Arms
Resolution	1.2mA/2.4mA	1.2mA/2.4mA	1.2mA/2.4mA	1.2mA/2.4mA
Accuracy	±0.05% of (reading + range) @ 50/60Hz, ±0.2% of (reading + range) @ other frequency			
Parameter	Irms, I Max/Min, ±Ipk			
WATT READBACK W METER				
Range	15000W	18750W	22500W	
Resolution	0.25W	0.3125W	0.375W	
Accuracy*4	±0.5% of (setting + range) @ 50/60Hz, ±2% of (setting + range) @ other frequency			
VA METER	Vrms x Arms correspond to Vrms and Arms			
Power Factor METER				
Range	±0.000~1.000			
Accuracy	±(0.002±(0.001/PF))*F			
Frequency METER(Hz)				
Range	DC,40~440Hz			
Accuracy	0.1%			
Other Parameter METER				
VA, VAR, CF_I, Ipeak, Imax., Imin. Vmax., Vmin., IHD, VHD, ITHD, VTHD				
OTHERS				
Start up loading	Yes , Power on loading during Inverter / UPS start up			
Load ON / OFF Angle	0 ~ 359 degree can be programmed for the angle of load ON and load OFF loading			
Half cycle and SCR/TRIAC loading	Positive or Negative half cycle, 90° Trailing edge or Leading edge current waveform can be programmed			
Master/Slave (3 phase or Parallel application)	Yes, 1 master and up to 7 slave unit			
External programming input	F.S / 10Vdc, Resolution 0.1V			

External SYNC input	TTL		
Vmonitor (Isolated)	±500V / ±10V		
Imonitor (Isolated)	±337.5Apk /±10Vpk	±337.5Apk / ±10Vpk	±337.5Apk /±10Vpk
Interface (OPTION)	GPIB; RS-232; LAN; USB		
MAX. Power consumption	510VA	630VA	750VA
Operation Temperature ^{*2}	0 – 40°C		
Current of input impedance (mA) @ 50/60Hz ; @400Hz	~V*2.4; ~V*17.6	~V*3.0 ; ~V*22	~V*3.6 ; ~V*26.4
Dimension(H x W x D)	813.5 x 480 x 593 mm	1283 x 600 x 600 mm	1283 x 600 x 600 mm
Weight	140kg	260kg	295kg

AEL-5006-425-56, AEL-5008-425-75, AEL-5012-425-112.5

MODEL	AEL-5006-425-56	AEL-5008-425-75	AEL-5012-425-112.5
Power (W)	5600W	7500W	11250W
Current(Ampere)	56Arms or Adc/ 168Apeak	75Arms or Adc/ 225Apeak	112.5Arms or Adc/ 337.5Apeak
Voltage(Volt)	50 ~ 425Vrms /5 ~ 600Vdc		
Slew Rate(DC)	50µs		
Frequency Range	DC, 40 ~ 440Hz(CC, CP Mode), DC ~ 440Hz(LIN, CR, CV Mode)		
PROTECTIONS			
Over Power Protection	≅ 5880Wrms or Programmable	≅ 7875Wrms or Programmable	≅ 11812.5Wrms or Programmable
Over Current Protection	≅ 58.8Arms, or Programmable	≅ 78.75Arms, or Programmable	≅ 118.125Arms or Programmable
Over Voltage Protection	≅ 446.25Vrms/630Vdc		
Over Temp. Protection	Yes		
OPERATION MODE			
Constant Current Mode for Sine-Wave			
Range	0~56A	0~75A	0~112.5A
Resolution	1mA/16bits	1.25mA/16bits	1.875mA/16bits
Accuracy	±(0.1% of setting + 0.2% of range)@50/60Hz, ±0.5% of (setting + range)@DC and 400Hz		
Linear Constant Current Mode for Sine-Wave, Square-Wave or Quasi-Square Wave, PWM Wave			
Range	0~56A	0~75A	0~112.5A
Resolution	1mA/16bits	1.25mA/16bits	1.875mA/16bits
Accuracy	±(0.1% of setting + 0.2% of range) @50/60Hz, ±0.5% of (setting + range)@DC and 400Hz		
Constant Resistance Mode			
Range	1Ω ~ 20kΩ	0.8Ω ~ 16kΩ	0.533Ω~10.666kΩ
Resolution ^{*1}	0.016666mS/16bits	0.020832mS/16bits	0.031248mS/16bits
Accuracy	±0.2% of (setting + range)@50/60Hz, ±(0.5% of setting + 2% of range)@DC and 400Hz		

Constant Voltage Mode				
Range	50–425Vrms / 600Vdc			
Resolution	0.1V			
Accuracy	±0.2% of (setting + range) @ 50/60Hz, ±0.4% of (setting + range)			
Constant Power Mode				
Range	5600W	7500W	11250W	
Resolution	1W	1W	1W	
Accuracy*4	±0.5% of (setting + range) @ 50/60Hz, ±2% of (setting + range) @ other frequency			
CREST factor (CC & CP MODE ONLY)				
Range	√2~5			
Resolution	0.1			
Accuracy	(0.5% / Irms) + 1%F.S.			
Power factor (CC & CP Mode only)				
Range	0~1 Lag or Lead			
Resolution	0.01			
Accuracy	1%F.S.			
TEST MODE				
UPS Efficient Measurement Non-Linear Mode				
Operating Frequency	Auto ; 40~440Hz			
Current Range	0~56A	0~75A	0~112.5A	
PF Range	0 ~1			
Measuring Efficiency for PV System, Power Conditioners Resistive + Non-Linear Mode for THD 80%				
Operating Frequency	Auto ; 40~440Hz			
Current Range	0~56A	0~75A	0~112.5A	
Resistive Range	1Ω ~ 20kΩ	0.8Ω ~ 16kΩ	0.533Ω~10.666kΩ	
UPS Back-Up function(CC,LIN,CR,CP)				
UVP (VTH)	50~425Vrms / 600Vdc			
UPS Back-Up Time	1~99999 Sec. (>27H)			
Battery Discharge function(CC,LIN,CR,CP)				
UVP (VTH)	50~425Vrms / 600Vdc			
Battery Discharge Time	1~99999 Sec. (>27H)			
UPS Transfer Time				
Current Range	0~56A	0~75A	0~112.5A	
UVP (VTH)	2.5V			
Time range	0.15mS~999.99mS			
Fuse Test mode				
Max. current	Turbo OFF(CC1~3)	75Arms	75Arms	112.5Arms
	Turbo ON	CC3 CC1~2	150Arms (x2)*3	150Arms(x2)*3 225Arms(x2)*3
Trip & non-trip time	Turbo OFF(TIME1~3)	0.01~333.33 sec.		
	Turbo ON	TIME 1~2	0.01~0.50 sec.	
		TIME3	0.01~600.00 sec.	

OFF TIME	0.01~9999.9 sec.			
Meas. Accuracy	±0.003 sec.			
Repeat Cycle	0~99999			
Short/OPP/OCP Test Function				
Short Time	Turbo OFF	0.1S ~ 10Sec. or Cont.		
	Turbo ON	0.1S ~ 1Sec		
OPP/OCP	Turbo OFF	100ms		
Step Time	Turbo ON	100ms, up to 10 Steps		
OCP Istop	Turbo OFF	56Arms	75Arms	112.5Arms
	Turbo ON	112Arms	150Arms	225Arms
OPP Pstop	Turbo OFF	5600W	7500W	11250W
	Turbo ON	11200W	15000W	22500W
Programmable Inrush current simulation: Istart - Istop/ Tsep				
Istart, Inrush Start Current	0~112A	0~150A	0~225A	
Inrush Step time	0.1mS~100mS			
Istop, Inrush stop current	0~56A	0~75A	0~112.5A	
Programmable Surge current simulation: S1/T1 - S2/T2 - S3/T3				
S1 and S2 Current	0~112A	0~150A	0~225A	
T1 and T2 Time	0.01S ~ 0.5Sec.			
S3 Current	0~56A	0~75A	0~112.5A	
T3 Time	0.01S~9.99Sec. Or Cont.			
MEASUREMENTS				
VOLTAGE READBACK V METER				
Range	600V			
Resolution	0.01V			
Accuracy	±0.05% of (reading + range)			
Parameter	Vrms, V Max/Min, ±Vpk			
CURRENT READBACK A METER				
Range	28Arms/56Arms	37.5Arms/75Arms	56.25Arms/112.5Arms	
Resolution	0.6mA/1.2mA	0.8mA/1.6mA	1.2mA/2.4mA	
Accuracy	±0.1% of (reading + range)@ 50/60Hz, ±0.4% of (reading + range)			
Parameter	Irms, I Max/Min, ±Ipk			
WATT READBACK W METER				
Range	5600W	7500W	11250W	
Resolution	0.1W	0.125W	0.1875W	
Accuracy ^{*4}	±0.5% of (reading + range)@ 50/60Hz, ±2% of (reading + range)@ other frequency			
VA METER	Vrms x Arms correspond to Vrms and Arms			
Power Factor METER				
Range	±0.000~1.000			
Accuracy	±(0.002±(0.001/PF)*F)			
Frequency METER(Hz)				
Range	DC,40~440Hz			
Accuracy	0.1%			

Other Parameter METER			
VA, VAR, CF_L, Ipeak, I _{max.} , I _{min.} , V _{max.} , V _{min.} , IHD, VHD, ITHD, VTHD			
OTHERS			
Start up loading	Yes, Power on loading during Inverter / UPS start up		
Load ON / OFF Angle	0 ~ 359 degree can be programmed for the angle of load ON and load OFF loading		
Half cycle and SCR/TRIAC loading	Positive or Negative half cycle, 90° Trailing edge or Leading edge current waveform can be programmed		
Master/Slave (3 phase or Parallel application)	Yes, 1 master and up to 7 slave unit		
External programming input	F.S / 10Vdc, Resolution 0.1V		
External SYNC input	TTL		
V _{monitor} (Isolated)	±600V / ±10V		
I _{monitor} (Isolated)	±168Apk / ±10Vpk	±225Apk / ±10Vpk	±337.5Apk / ±10Vpk
Interface (OPTION)	GPIB; RS-232; LAN; USB		
MAX. Power consumption	270VA	270VA	390VA
Operation Temperature *2	0 ~ 40°C		
Current of input impedance(mA) @ 50/60Hz; @400Hz	~V*0.9; ~V*6.6	~V*1.2; ~V*8.8	~V*1.8; ~V*13.2
Dimension(H x W x D)	457.8 x 480 x 593 mm	457.8 x 480 x 593 mm	635.7 x 480 x 593 mm
Weight	58 kg	70 kg	105kg

AEL-5015-425-112.5, AEL-5019-425-112.5, AEL-5023-425-112.5

MODEL	AEL-5015-425-112.5	AEL-5019-425-112.5	AEL-5023-425-112.5
Power (W)	15000 W	18750W	22500W
Current(Ampere)	112.5 Arms or Adc/ 337.5Apeak	112.5 Arms or Adc/ 337.5Apeak	112.5Arms or Adc/ 337.5Apeak
Voltage(Volt)	50 ~ 425Vrms/ 5 ~ 600Vdc		
Slew Rate(DC)	50μs		
Frequency Range	DC, 40 ~ 440Hz(CC, CP Mode), DC ~ 440Hz(LIN, CR, CV Mode)		
PROTECTIONS			
Over Power Protection	≅ 15750Wrms or Programmable	≅ 19687.5Wrms or Programmable	≅ 23625Wrms or Programmable
Over Current Protection	≅ 118.125Arms or Programmable		
Over Voltage Protection	≅ 446.25Vrms/630Vdc		
Over Temp. Protection	Yes		
OPERATION MODE			
Constant Current Mode for Sine-Wave			
Range	0~112.5A		
Resolution	1.875mA/16bits		

Accuracy	±(0.1% of setting + 0.2% of range) @50/60Hz, ±0.5% of (setting + range) @DC and 400Hz		
Linear Constant Current Mode for Sine-Wave, Square-Wave or Quasi-Square Wave, PWM Wave			
Range	0~112.5A		
Resolution	1.875mA/16bits		
Accuracy	±(0.1% of setting + 0.2% of range) @50/60Hz, ±0.5% of (setting + range) @DC and 400Hz		
Constant Resistance Mode			
Range	0.533Ω ~ 10.666kΩ		
Resolution ^{*1}	0.031248mS/16bits		
Accuracy	±0.2% of (setting + range) @50/60Hz, ±(0.5% of setting + 2% of range) @DC and 400Hz		
Constant Voltage Mode			
Range	50~425Vrms / 600Vdc		
Resolution	0.1V		
Accuracy	±0.2% of (setting + range) @ 50/60Hz, ±0.4% of (setting + range)		
Constant Power Mode			
Range	15000 W	18750W	22500W
Resolution	1W		
Accuracy ^{*4}	±0.5% of (reading + range) @ 50/60Hz, ±2% of (reading + range) @ other frequency		
CREST factor (CC & CP Mode only)			
Range	√2~5		
Resolution	0.1		
Accuracy	(0.5% / Irms) + 1% F.S.		
Power factor (CC & CP Mode only)			
Range	0~1 Lag or Lead		
Resolution	0.01		
Accuracy	1% F.S.		
TEST MODE			
UPS Efficient Measurement	Non-Linear Mode		
Operating Frequency	Auto; 40~440Hz		
Current Range	0~112.5A		
PF Range	0 ~1		
Measuring Efficiency for PV System, Power Conditioners for THD 80%	Resistive + Non-Linear Mode		
Operating Frequency	Auto ; 40~440Hz		
Current Range	0~112.5A		
Resistive Range	0.533Ω ~ 10.666kΩ		
UPS Back-Up function(CC,LIN,CR,CP)			
UVP (VTH)	50~425Vrms / 600Vdc		
UPS Back-Up Time	1~99999 Sec. (>27H)		
Battery Discharge function(CC,LIN,CR,CP)			
UVP (VTH)	50~425Vrms / 600Vdc		
Battery Discharge Time	1~99999 Sec. (>27H)		

UPS Transfer Time				
Current Range	0~112.5A			
UVP (VTH)	2.5V			
Time range	0.15mS~999.99mS			
Fuse Test mode				
Max. current	Turbo OFF(CC1~3)	112.5Arms		
	Turbo ON	CC3	225Arms (x2)**3	
Trip & non-trip time	Turbo OFF(TIME1~3)	0.01~333.33 sec.		
	Turbo ON	TIME 1~2	0.01~0.50 sec.	
		TIME3	0.01~600.00 sec.	
OFF TIME	0.01~9999.9 sec.			
Meas. Accuracy	±0.003 sec.			
Repeat Cycle	0~99999			
Short/OPP/OCP Test Function				
Short Time	Turbo OFF	0.1S ~ 10Sec. or Cont.		
	Turbo ON	0.1S ~ 1Sec		
OPP/OCP	Turbo OFF	100ms		
Step Time	Turbo ON	100ms, up to 10 Steps		
OCP Istop	Turbo OFF	112.5Arms		
	Turbo ON	225Arms		
OPP Pstop	Turbo OFF	15000W	18750W	22500W
	Turbo ON	30000W	37500W	45000W
Programmable Inrush current simulation: Istart - Istop/ Tsep				
Istart, Inrush Start Current	0~225A			
Inrush Step time	0.1mS~100mS			
Istop, Inrush stop current	0~112.5A			
Programmable Surge current simulation: S1/T1 - S2/T2 - S3/T3				
S1 and S2 Current	0~225A			
T1 and T2 Time	0.01S ~ 0.5Sec.			
S3 Current	0~112.5A			
T3 Time	0.01S~9.99Sec. Or Cont.			
MEASUREMENTS				
VOLTAGE READBACK V METER				
Range	600V			
Resolution	0.01V			
Accuracy	±0.05% of (reading + range)			
Parameter	Vrms, V Max/Min, ±Vpk			
CURRENT READBACK A METER				
Range	56.25Arms/112.5Arms			
Resolution	1.2mA/2.4mA			
Accuracy	±0.1% of (reading + range) @ 50/60Hz, ±0.4% of (reading + range)			
Parameter	Irms, I Max/Min, ±Ipk			
WATT READBACK W METER				
Range	15000W	18750W	22500W	
Resolution	0.25W	0.3125W	0.375W	

Accuracy ^{*4}	±0.5% of (reading+range) @ 50/60Hz, ±2% of (reading + range) @ other frequency		
VA METER	Vrms x Arms correspond to Vrms and Arms		
Power Factor METER			
Range	±0.000~1.000		
Accuracy	±(0.002±(0.001/PF)*F)		
Frequency METER(Hz)			
Range	DC,40~440Hz		
Accuracy	0.1%		
Other Parameter METER	VA, VAR, CF_I, Ipeak, Imax., Imin, Vmax., Vmin., IHD, VHD, ITHD, VTHD		
OTHERS			
Start up loading	Yes , Power on loading during Inverter / UPS start up		
Load ON / OFF Angle	0 ~ 359 degree can be programmed for the angle of load ON and load OFF loading		
Half cycle and SCR/TRIAC loading	Positive or Negative half cycle, 90° Trailing edge or Leading edge current waveform can be programmed		
Master/Slave (3 phase or Parallel application)	Yes, 1 master and up to 7 slave unit		
External programming input	F.S / 10Vdc, Resolution 0.1V		
External SYNC input	TTL		
Vmonitor (Isolated)	±600V / ±10V		
Imonitor (Isolated)	±337.5Apk /±10Vpk		
Interface (OPTION)	GPIB; RS-232; LAN; USB		
MAX. Power consumption	510VA	630VA	750VA
Operation Temperature ^{*2}	0 ~ 40°C		
Current of input impedance (mA) @ 50/60Hz ; @400Hz	~V*2.4 ; ~V*17.6	~V*3.0 ; ~V*22	~V*3.6 ; ~V*26.4
Dimension(H x W x D)	813.5 x 480 x 593 mm	1283 x 600 x 600 mm	1283 x 600 x 600 mm
Weight	140kg	260kg	295kg

AEL-5003-480-18.75, AEL-5004-480-28

MODEL	AEL-5003-480-18.75	AEL-5004-480-28
Power (W)	2800W	3750W
Current(Ampere)	18.75Arms or Adc/ 56.25Apeak	28Arms or Adc/ 84Apeak
Voltage(Volt)	50~480Vrms/ 5 ~ 700Vdc	
Slew Rate(DC)	50µs	
Frequency Range	DC, 40 ~ 70Hz(CC, CP Mode), DC ~ 70Hz(LIN, CR, CV Mode)	
PROTECTIONS		
Over Power Protection	≅ 2940Wrms or Programmable	≅ 3937.5Wrms or Programmable
Over Current Protection	≅ 19.687 Arms or Programmable	≅ 29.4 Arms or Programmable
Over Voltage Protection	≅ 504Vrms / 735Vdc	
Over Temp. Protection	Yes	

OPERATION MODE		
Constant Current Mode for Sine-Wave		
Range	0~18.75A	0~28A
Resolution	0.3125mA/16bits	0.5mA/16bits
Accuracy	±(0.1% of setting + 0.2% of range) @50/60Hz, ±0.5% of (setting + range) @DC and 400Hz	
Linear Constant Current Mode for Sine-Wave, Square-Wave or Quasi-Square Wave, PWM Wave		
Range	0~18.75A	0~28A
Resolution	0.3125mA/16bits	0.5mA/16bits
Accuracy	±(0.1% of setting + 0.2% of range) @50/60Hz, ±0.5% of (setting + range) @DC and 400Hz	
Constant Resistance Mode		
Range	4Ω ~ 80kΩ	2.5Ω ~ 50kΩ
Resolution ^{*1}	0.004166mS/16bits	0.006666mS/16bits
Accuracy	±0.2% of (setting + range) @50/60Hz, ±(0.5% of setting + 2% of range) @DC and 400Hz	
Constant Voltage Mode		
Range	50~480Vrms / 700Vdc	
Resolution	0.0125V	
Accuracy	±(0.1% of setting + 0.1 of range)	
Constant Power Mode		
Range	2800W	3750W
Resolution	0.1W	0.1W
Accuracy ^{*4}	±0.5% of (setting + range) @ 50/60Hz, ±2% of (setting + range) @ other frequency	
CREST factor (CC & CP Mode only)		
Range	√2~5	
Resolution	0.1	
Accuracy	(0.5% / Irms) + 1% F.S.	
Power factor (CC & CP Mode only)		
Range	0~1 Lag or Lead	
Resolution	0.01	
Accuracy	1% F.S.	
TEST MODE		
UPS Efficient Measurement	Non-Linear Mode	
Operating Frequency	Auto; 40~70Hz	
Current Range	0~18.75A	0~28A
PF Range	0 ~1	
Measuring Efficiency for PV System, Power Conditioners for THD 80%	Resistive + Non-Linear Mode	
Operating Frequency	Auto ; 40~70Hz	
Current Range	0~18.75A	0~28A
Resistive Range	4Ω ~ 80kΩ	2.5Ω ~ 50kΩ
UPS Back-Up function(CC,LIN,CR,CP)		
UVP (VTH)	50~480Vrms / 700Vdc	

UPS Back-Up Time	1~99999 Sec. (>27H)		
Battery Discharge function(CC,LIN,CR,CP)			
UVP (VTH)	50~480Vrms / 700Vdc		
Battery Discharge Time	1~99999 Sec. (>27H)		
UPS Transfer Time			
Current Range	0~18.75A	0~28A	
UVP (VTH)	2.5V		
Time range	0.15mS~999.99mS		
Fuse Test mode			
Max. current	Turbo OFF(CC1~3)	18.75Arms	28.0Arms
	Turbo ON	CC3	
	CC1~2	37.5Arms (x2)*3	56.0Arms(x2)*3
Trip & non-trip time	Turbo OFF(TIME1~3)	0.01~333.33 sec.	
	Turbo ON	TIME 1~2	0.01~0.50 sec.
	TIME3	0.01~600.00 sec.	
OFF TIME	0.01~9999.9 sec.		
Meas. Accuracy	±0.003 sec.		
Repeat Cycle	0~99999		
Short/OPP/OCF Test Function			
Short Time	Turbo OFF	0.1S ~ 10Sec. or Cont.	
	Turbo ON	0.1S ~ 1Sec	
OPP/OCF	Turbo OFF	100ms	
Step Time	Turbo ON	100ms, up to 10 Steps	
OCF Istop	Turbo OFF	18.75Arms	28.0Arms
	Turbo ON	37.5Arms	56.0Arms
OPP Pstop	Turbo OFF	2800W	3750W
	Turbo ON	5600W	7500W
Programmable Inrush current simulation: Istart - Istop/ Tsep			
Istart, Inrush Start Current	0~37.5A	0~56A	
Inrush Step time	0.1mS~100mS		
Istop, Inrush stop current	0~18.75A	0~28A	
Programmable Surge current simulation: S1/T1 - S2/T2 - S3/T3			
S1 and S2 Current	0~37.5A	0~56A	
T1 and T2 Time	0.01S ~ 0.5Sec.		
S3 Current	0~18.75A	0~28A	
T3 Time	0.01S~9.99Sec. Or Cont.		
MEASUREMENTS			
VOLTAGE READBACK V METER			
Range	700V		
Resolution	0.0125V		
Accuracy	±0.05% of (reading + range)		
Parameter	Vrms, V Max/Min, ±Vpk		
CURRENT READBACK A METER			
Range	9.375Arms/18.75Arms	14Arms/28Arms	
Resolution	0.2mA/0.4mA	0.3mA/0.6mA	

Accuracy	±0.05% of (reading+range)@ 50/60Hz, ±0.2% of (reading + range)@ other frequency	
Parameter	Irms, I Max/Min, ±Ipk	
WATT READBACK W METER		
Range	2800W	3750W
Resolution	0.05W	0.0625W
Accuracy*4	±0.5% of (reading + range)@ 50/60Hz, ±2% of (reading + range)@ other frequency	
VA METER	Vrms x Arms correspond to Vrms and Arms	
Power Factor METER		
Range	±0.000~1.000	
Accuracy	±(0.002±(0.001/PF)*F)	
Frequency METER(Hz)		
Range	DC,40~70Hz	
Accuracy	0.1%	
Other Parameter METER		
	VA, VAR, CF_L, Ipeak, Imax., Imin. Vmax., Vmin., IHD, VHD, ITHD, VTHD	
OTHERS		
Start up loading	Yes , Power on loading during Inverter / UPS start up	
Load ON / OFF Angle	0 ~ 359 degree can be programmed for the angle of load ON and load OFF loading	
Half cycle and SCR/TRIAC loading	Positive or Negative half cycle, 90° Trailing edge or Leading edge current waveform can be programmed	
Master/Slave (3 phase or Parallel application)	Yes, 1 master and up to 7 slave unit	
External programming input	F.S / 10Vdc, Resolution 0.1V	
External SYNC input	TTL	
Vmonitor (Isolated)	±700V / ±10V	
Imonitor (Isolated)	±56.25Apk /±10Vpk	±84Apk /±10Vpk
Interface (OPTION)	GPIB; RS-232; LAN; USB	
MAX. Power consumption	150VA	150VA
Operation Temperature *2	0 ~ 40°C	
Current of input impedance(mA) @ 50/60Hz ; @400Hz	~V*0.3 ; ~V*2.2	~V*0.4 ; ~V*2.95
Dimension(H x W x D)	177 x 440 x 552.6 mm	
Weight	27.5Kg	33.5Kg

*1 ms (millisiemens) is the unit of conductance(G), one siemens equal to 1/Ω

*2 Operating temperature range is 0~40°C, all specification apply for 25°C±5°C, Except as noted

*3 Turbo mode for up to 2X Current rating & Power rating support Fuse, Short/OCP/OPP test function.

*4 The specification apply for current less than 20Arms.

* All specifications apply for 50/60Hz. and subject to change without notice.

Certificate Of Compliance

We

GOOD WILL INSTRUMENT CO., LTD.

declare that the CE marking mentioned product

satisfies all the technical relations application to the product within the scope of council:

Directive: EMC; LVD; WEEE; RoHS

The product is in conformity with the following standards or other normative documents:

© EMC	
EN 61326-1	Electrical equipment for measurement, control and laboratory use -- EMC requirements
Conducted & Radiated Emission EN 55011 / EN 55032	Electrical Fast Transients EN 61000-4-4
Current Harmonics EN 61000-3-2 / EN 61000-3-12	Surge Immunity EN 61000-4-5
Voltage Fluctuations EN 61000-3-3 / EN 61000-3-11	Conducted Susceptibility EN 61000-4-6
Electrostatic Discharge EN 61000-4-2	Power Frequency Magnetic Field EN 61000-4-8
Radiated Immunity EN 61000-4-3	Voltage Dip/ Interruption EN 61000-4-11 / EN 61000-4-34
© Safety	
EN 61010-1 :	Safety requirements for electrical equipment for measurement, control, and laboratory use - Part 1: General requirements

GOODWILL INSTRUMENT CO., LTD.

No. 7-1, Jhongsing Road, Tucheng District, New Taipei City 236, Taiwan

Tel: [+886-2-2268-0389](tel:+886-2-2268-0389)

Fax: [+886-2-2268-0639](tel:+886-2-2268-0639)

Web: <http://www.gwinstek.com> Email: marketing@goodwill.com.tw

GOODWILL INSTRUMENT (SUZHOU) CO., LTD.

No. 521, Zhujiang Road, Snd, Suzhou Jiangsu 215011, China

Tel: [+86-512-6661-7177](tel:+86-512-6661-7177)

Fax: [+86-512-6661-7277](tel:+86-512-6661-7277)

Web: <http://www.instek.com.cn> Email: marketing@instek.com.cn

GOODWILL INSTRUMENT EURO B.V.

De Run 5427A, 5504DG Veldhoven, The Netherlands

Tel: [+31-\(0\)40-2557790](tel:+31-(0)40-2557790)

Fax: [+31-\(0\)40-2541194](tel:+31-(0)40-2541194)

Email: sales@gw-instek.eu

GPIB programming Example

C Example Program

```
/* Link this program with appropriate *cib*.obj. */

/* This application program is written in TURBO C 2.0 for the IBM
PC-AT compatible. The National Instruments Cooperation (NIC)
Model PC-2A board provides the interface between the PC-AT and
a PRODIGIT MPAL ELECTRONIC LOAD. The appropriate *cib*.obj
file is required in each program to properly link the NIC board to C
LANGUAGE. and include the <decl.h.> HEADER FILE to C
LANGUAGE. */

#include <stdio.h>
#include <dos.h>
#include <math.h>
#include "decl.h"      /* NI GPIB CARD HEADER FILE */

main()
{
    char ouster[20],rdbuf[15],spec[10];
    int i,ch,load;

    /* Assign unique identifier to the device "dev5" and store in
variable load. check for error. ibfind error = negative value returned.
*/

    if((load = ibfind("dev5")) < 0) /* Device variable name is load */
    {
        /* GPIB address is 5 */
        printf("\r*** INTERFACE ERROR ! ***\a\n");
        printf("\r\nError routine to notify that ibfind failed.\n");
        printf("\r\nCheck software configuration.\n");
    }
}
```

```

    exit(1);
}
/* Clear the device */
if((ibclr(load)) & ERR);
{
    printf("INTERFACE ERROR ! \a");
    exit (1);
}
clrscr();
/* Clear load error register */
{
    outstr=chan[0];
    ibwrt(load,outstr,6);
    ibwrt(load,"CLR",3);
}

    ibwrt( load,"NAME?",5);          /* Get the AEL-5000 Series
load specification */
    strset(rdbuf,'\0');             /* Clear rdbuf string
buffer */
    strset(spec,'\0');              /* Clear spec string buffer
*/
    ibrd(load,spec,20);
    if (spec[3] == '9')
        printf("\n AEL-5000 Series specification error !");
/* Set the channel 1, preset off, current sink 1.0 amps and load on
commands to the load. */
    ibwrt( load,"chan 1;pres off;curr:B 0.0;curr:A 1.0;load on",43);
    ibwrt( load,"meas:curr ?",10);
/* Get the load actually sink current from the load */
    ibrd( load,rdbuf,20);

```

```
/* go to local. */  
  ibloc(load);  
}
```

BASICA Example Program

LOAD DECL.BAS using BASICA MERGE command.

```
100 REM You must merge this code with DECL.BAS  
105 REM  
110 REM Assign a unique identifier to the device "dev5" and store it  
    in variable load%.  
125 REM  
130     udname$ = "dev5"  
140     CALL ibfind (udname$,load%)  
145 REM  
150 REM Check for error on ibfind call  
155 REM  
160     IF load% < 0 THEN GOTO 2000  
165 REM  
170 REM Clear the device  
175 REM  
180     CALL ibclr (load%)  
185 REM  
190 REM Get the 36260 load specification  
195 REM  
200     wrt$ = "NAME?" : CALL ibwrt(load%,wrt$)  
210     rd$ = space$(20) : CALL ibrd(load%,rd$)  
215 REM  
220 REM Set the preset off, current sink 1.0 amps and load on  
    commands to the load.
```

225 REM

230 wrt\$ = "pres off;curr:B 0.0;curr:A 1.0;load on"

240 CALL ibwrt(load%,wrt\$)

245 REM

250 REM Get the load actually sink current from the load

255 REM

260 wrt\$ = "meas:curr?" : CALL ibwrt(load%,wrt\$)

270 rd\$ = space\$(20) : CALL ibrd(load%,rd\$)

275 REM

280 REM Go to local

285 REM

290 CALL ibloc(load%)

2000 REM Error routine to notify that ibfind failed.

2010 REM Check software configuration.

2020 PRINT "ibfind error !" : STOP

AEL-5000 Series USB Instruction

Steps

1. Install the USB DRIVER select USB\SETUP\PL-2303 Driver Installer.exe

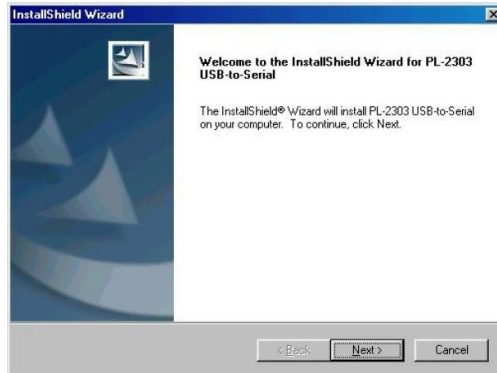

2. After the installation, connect the AEL-5000 series and PC with USB. Then select the item USB to Serial Port (COM3), set the BAUD-RATE and Flow control to 115200bps and Hardware to control AEL-5000 series with COM3.

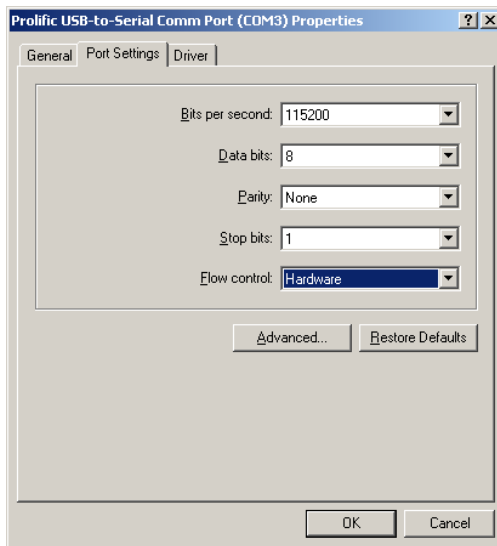
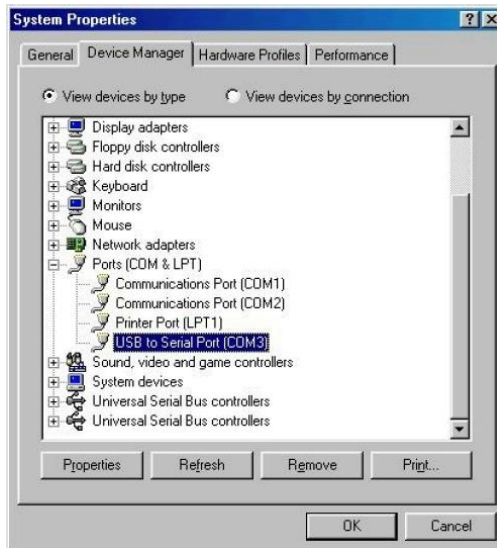

AEL-5000 series Auto-Sequence function provide EDIT, ENTER, EXIT, TEST and STORE 5 keys operation

- | | |
|-----------|---|
| Edit mode | <ol style="list-style-type: none">1. Set mode, Range, current level ... Load Setting an, Load ON.2. Press STORE key to store the load setting in memory STATE3. Repeat 1~2, for the sequence load setting.4. Press SEQ key of AEL-5000 series front panel.5. Press up/down key to select Edit Mode.6. Press 1~9 number key program number.7. Press STATE up/down key to select memory state.8. Press ENTER to next step.9. Repeat 6~8 to edit Step of sequence10. Press SAVE to confirm the step11. LCD shows "rept" to setting repeat count.12. Press up/down key to set repeat count of sequence loop.13. Press ENTER to confirm the sequence edit. |
| Test mode | <ol style="list-style-type: none">1. Press SEQ key of AEL-5000 series front panel.2. Press up/down key to select Test Mode.3. Press 1~9 number to select sequence number.4. Press ENTER to execution the sequence.5. The LCD shows "PASS" or "FAIL" after testing. |

AUTO SEQUENCE:

Auto sequence set command	Note	Return
FILE{SP}{n}{; NL}	n=1~9	
FILE{?}{; NL}		1~9
STEP{SP}{n}{; NL}	n=1~32	
STEP{?}{; NL}		1~32
TOTSTEP{SP}{n}{; NL}	Total step n=1~32	
TOTSTEP{?}{; NL}		1~32
SB{SP}{n}{; NL}	n=1~150	
SB{?}{; NL}		1~150
TIME{SP}{NR2}{; NL}	100~9999(ms)	100~9999(ms)
SAVE{; NL}	Save "File n" data	
REPEAT{SP}{n}{; NL}	n=0~9999	
REPEAT{?}{; NL}		0~9999
RUN{SP}{F}{n}{; NL}	n=1~9	Auto reply "PASS" or "FAIL:XX" (XX = NG STEP)
BEEP{SP}{ON OFF}{; NL}	Set buzzer ON/OFF	

Example Sequence

In this example, we will create a program based on following Figure.

The program repeats steps 1 to 8 two times. After repeating the sequence two times, the load is turned off and the sequence ends.

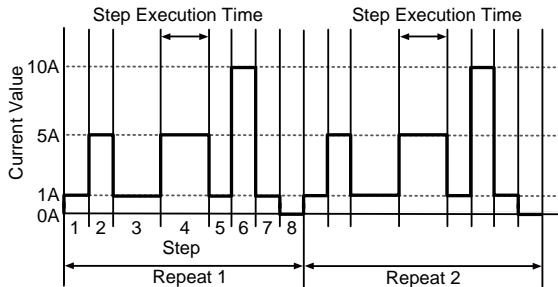

Sequence Number	Step Number	Current Value	Execution Time (T1+T2)
3	1	1A	200mS
3	2	5A	200mS
3	3	1A	400mS
3	4	5A	400mS
3	5	1A	200mS
3	6	10A	200mS
3	7	1A	200mS
3	8	0A	200mS

T1 means that the minimum delay time is 0 ms, while T2 means that the minimum interval time is 100ms.

- Creating the program
1. Setting the Load current level and store to state 1~8.
 2. Set the operation mode.
Press the mode key to CC mode.
 3. Press Load ON.
 4. Set the current value as step 1~8 and store to memory state 1~8.
 5. Press EDIT key of AEL-5000 series mainframe.
 6. Press up/down key to select Edit Mode.
 7. Press sequence number 3 to edit the sequence.
 8. Press up/down key to memory state 1.
 9. Press ENTER key to confirm the sequence memory.
 10. Press up/down key to setting execution time.
 11. Press ENTER key to confirm the sequence step.
 12. Repeat 8~12 to setting step 1~8.
 13. Press SAVE key to confirm step 1~8.

14. Press up/down key to 1 to repeat one times.
15. Press ENTER to confirm the repeat count.

Testing Waveform

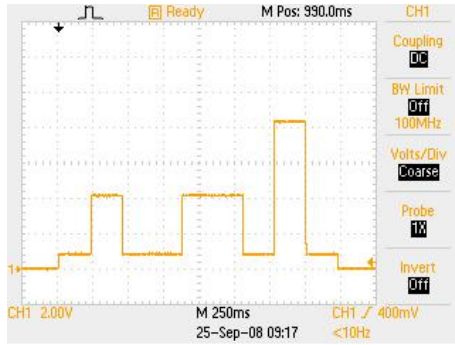

Example
Sequence in
Communication
Interface
Programming
Command mode

In this example, we will create a program based on following table.
The program repeats steps 1 to 3 two times. After repeating the sequence two times, the sequence ends.

Sequence Number	Step	Current Value	Execution Time
1	1	3A	500mS
1	2	5A	500mS
1	3	0A	500mS

Save the setting status to each group of memory

1. Store to memory 1:

```
MODE CC
CC: A 3.0
LOAD ON
STORE 1
```

2. Store to memory 2:

```
MODE CC
CC:A 5.0
LOAD ON
STORE 2
```

3. Store to memory 3:

MODE CC

CC:A 5.0

LOAD OFF

STORE 3

Auto SEQ Communication Interface Programming Command

example as below:

Item	Command	Description
1	FILE 1	;Edit file 1
2	STEP 1	;Edit step 1
3	SB 1	;Select bench (memory 1)
4	TIME 500	;Setting Dwell time 500ms
5	STEP 2	;Edit step 2
6	SB 2	;Select bench (memory 2)
7	TIME 500	;Setting Dwell time 500ms
8	STEP 3	;Edit step 3
9	SB 3	;Select bench (memory 3)
10	TIME 500	;Setting Dwell time 500ms
11	TOTSTEP 3	;Total step 3
12	REPEAT 2	;Repeat execute 2 times
13	SAVE	;Save the process
14	RUN F1	;Run File 1 test sequence

Testing Waveform

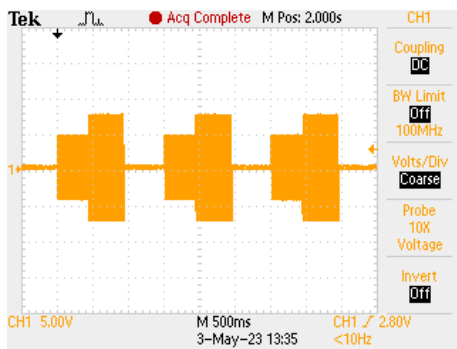

AEL-5000 Series LAN Instruction

Background

1. Connecting AC power and the network line to the AEL-5000 series mainframe, connect the other Side of the network line to the HUB.
 - a. For Windows XP:
Run the ETM.EXE (This file can be downloaded from GW Instek website), it will show as fig below. If not , please press F5 to search again, or check the first step was succeed or not. (The initial IP address of the LAN card is based on the actual product label)

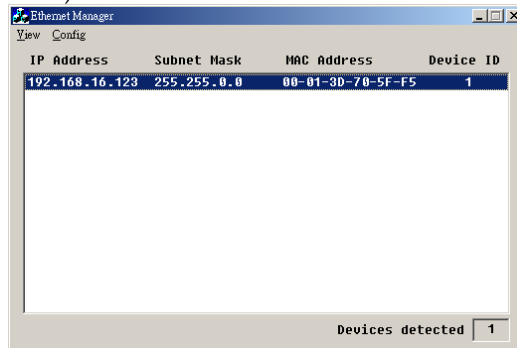

- b. For Windows 7, 8 and 10: Run the IPScanner.EXE(This file can be downloaded from GW Instek website) , If a Windows security alert appears, please select a public network, and then click "Allow Access", the following screen will appear. if not , please press F5 to search again, or check the first step was succeed or not.

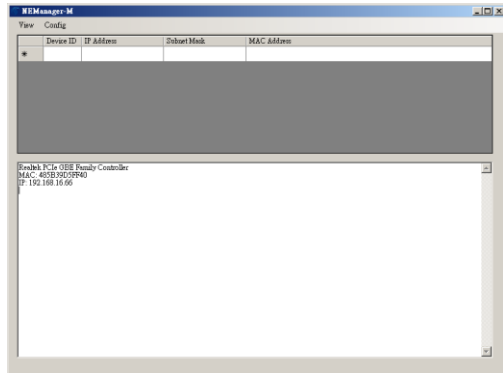

2. It will be shown the installation which has been searched on the screen , click it and select the Set IP Address bellows Config :

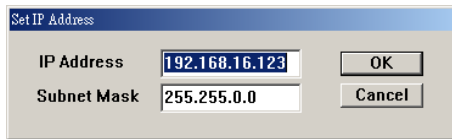

3. Set a useful IP Address and Subnet Mask.
4. It will be shown the Setup Device as the following figure if all steps was corrected to be run.

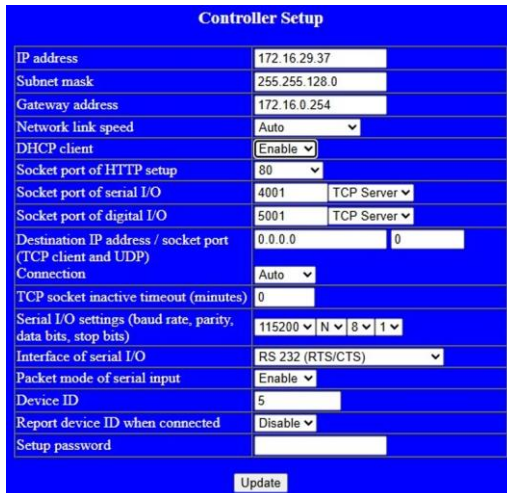

5. Insert the numbers as the following:
 - IP Address: as recommended according to your network
 - A. Subnet Mask: as recommended according to your network
 - B. Gateway Address: as recommended according to your network
 - C. Network link speed: Auto
 - D. DHCP client: Enable
 - E. Socket port of HTTP setup: 80
 - F. Socket port of serial I/O: 4001 , TCP Server
 - G. Socket port of digital I/O: 5001 , TCP Server
 - H. Destination IP address / socket port (TCP client and UDP) Connection: Auto
 - I. TCP socket inactive timeout(minutes): Set the network disconnection after N minutes, set 0 minutes will work forever.
 - J. Serial I/O settings (baud rate, parity, data, bits, stop bits): 115200, N, 8, 1
 - K. Interface of serial I/O: RS 232 (RTS/CTS)
 - L. Packet mode of serial input: Enable
 - M. Device ID: 5
 - N. Report device ID when connected: Disable
 - O. Setup password: Not required