

Multi-Range DC Power Supply

PSB-1000 Series

QUICK START GUIDE

GW INSTEK PART NO. 82SB-18000Mo1



ISO-9001 CERTIFIED MANUFACTURER

GW INSTEK

This manual contains proprietary information, which is protected by copyright. All rights are reserved. No part of this manual may be photocopied, reproduced or translated to another language without prior written consent of Good Will Corporation.

The information in this manual was correct at the time of printing. However, Good Will continues to improve its products and therefore reserves the right to change the specifications, equipment, and maintenance procedures at any time without notice.

Good Will Instrument Co., Ltd. No. 7-1, Jhongsing Rd., Tucheng Dist., New Taipei City 236, Taiwan.

S SAFETY INSTRUCTIONS

This section contains the basic safety symbols that may appear on the accompanying User Manual CD or on the instrument. For detailed safety instructions and precautions, please see the Safety Instructions chapter in the user manual CD.

Safety Symbols

These safety symbols may appear in the user manual or on the instrument.



Warning: Identifies conditions or practices that could result in injury or loss of life.



Caution: Identifies conditions or practices that could result in damage to the PSB-1000 or to other properties.



DANGER High Voltage



Attention Refer to the Manual



Protective Conductor Terminal



Earth (ground) Terminal



Do not dispose electronic equipment as unsorted municipal waste. Please use a separate collection facility or contact the supplier from which this instrument was purchased.

Power Cord for the United Kingdom

When using the instrument in the United Kingdom, make sure the power cord meets the following safety instructions.

NOTE: This lead/appliance must only be wired by competent persons.



WARNING: THIS APPLIANCE MUST BE EARTHED
IMPORTANT: The wires in this lead are coloured in accordance with the following code:

Green/ Yellow: Earth
Blue: Neutral
Brown: Live (Phase)



As the colours of the wires in main leads may not correspond with the coloured marking identified in your plug/appliance, proceed as follows:

The wire which is coloured Green & Yellow must be connected to the Earth terminal marked with either the letter E, the earth symbol  or coloured Green/Green & Yellow.

The wire which is coloured Blue must be connected to the terminal which is marked with the letter N or coloured Blue or Black.

The wire which is coloured Brown must be connected to the terminal marked with the letter L or P or coloured Brown or Red.

If in doubt, consult the instructions provided with the equipment or contact the supplier.

This cable/appliance should be protected by a suitably rated and approved HBC mains fuse: refer to the rating information on the equipment and/or user instructions for details. As a guide, a cable of 0.75mm² should be protected by a 3A or 5A fuse. Larger conductors would normally require 13A types, depending on the connection method used.

Any exposed wiring from a cable, plug or connection that is engaged in a live socket is extremely hazardous. If a cable or plug is deemed hazardous, turn off the mains power and remove the cable, any fuses and fuse assemblies. All hazardous wiring must be immediately destroyed and replaced in accordance to the above standard.

GETTING STARTED

The Getting Started chapter describes the power source in a nutshell, including its main features and front/rear panel introduction.

Overview

The PSB-1000 Series consists of 4 models: PSB-1400L, PSB-1400M, PSB-1800L, and PSB-1800M. Note that throughout the user manual, the term “PSB-1000” refers to all the models in the PSB-1000 Series lineup, unless stated otherwise.

Model Line Up

Model name	Output Voltage	Output Current	Output Power
PSB-1400L	40	40	400
PSB-1400M	160	10	400
PSB-1800L	40	80	800
PSB-1800M	160	20	800

Main Features

- | | |
|-------------|--|
| Performance | <ul style="list-style-type: none">• Maximum output voltage of 160V• Maximum output current of 80A |
|-------------|--|

Features	<ul style="list-style-type: none"> • OVP, OCP and OTP protection • Low AC input protection • Sequence function • Large 3.5 inch LCD panel • 100V - 240V power inlet • Multi-range output power • Bleeder circuit ON/OFF setting • CV, CC priority start function • Internal resistance setting function • Parallel master/slave operation with active current sharing • Remote sensing to compensate for voltage drop in load leads • Analog output programming and monitoring
----------	--

Interface	<ul style="list-style-type: none"> • Ethernet port • USB host • USB CDC • GPIB (optional) • External Control I/O
-----------	---

Accessories

Standard Accessories

Item	Part Number
User manual, programming manual	CD ROM
Power cord	
Output terminal cover	PSW-009
Type A - B USB Cable	GTL-240

Continued on the next page...

Basic Accessory Kit: M4 terminal screws and washers x2, M8 terminal bolts, nuts and washers x2, Analog control protection dummy x1, analog control lock level x2, short bar x1.	PSB-106
--	---------

Optional Accessories

Item	Part Number
Analog remote control connector kit: Socket x 1pc Pins x 10pcs Protection cover x 1 set Chassis connection wire x 1	PSW-001
Simple IDC tool	PSW-002
Contact removal tool	PSW-003
Cable for 2 units of PSB-1000 units in parallel mode connection	PSB-101
Cable for 3 units of PSB-1000 units in parallel mode connection	PSB-102
Cable for 4 units of PSB-1000 units in parallel mode connection	PSB-103
Cable for 2 units of PSB-1000 units in series mode connection	PSB-104
GPIB card	PSB-105
Rack-mount adapter(JIS)	GRA-418-J
Rack-mount adapter(EIA)	GRA-418-E
Test leads: 1x red, 1x black	GTL-123

Download

Item	Description
gw_psb1k.inf	USB driver

Front Panel

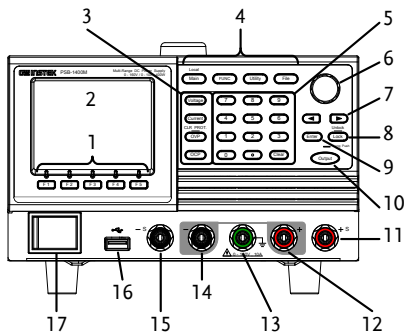

Description

- | | |
|---|---|
| 1. F1~F5 soft-keys | 2. LCD display |
| 3. Voltage, Current, OVP/CLR PROT, OCP keys | 4. Menu keys: Main/Local, FUNC, Utility, File |
| 5. Number pad | 6. Scroll wheel |
| 7. Arrow keys | 8. Lock/unlock key |
| 9. Enter key | 10. Output key |
| 11. Sense+ terminal | 12. +Terminal |
| 13. Ground terminal | 14. -Terminal |
| 15. Sense- terminal | 16. USB A port |
| 17. Power switch | |

Rear Panel

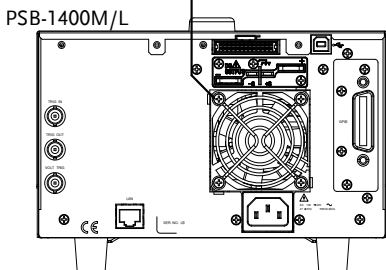
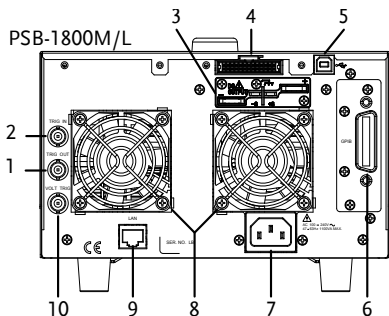

Description

- | | |
|-------------------------|-----------------|
| 1. TRIG OUT | 2. TRIG IN |
| 3. Rear panel terminals | 4. J1connector |
| 5. USB B port | 6. GPIB option |
| 7. Line input | 8. Fan |
| | x1: PSB-1800M/L |
| | x2: PSB-1400M/L |
| 9. LAN port | 10. VOLT TRIG |

Status Bar Icons

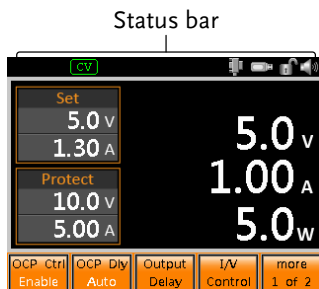

Description

	Output OFF		OVP tripped
	CV mode active		OCP tripped
	CC mode active		OTP tripped
	Output operating at 105% rated power (CP mode)		Remote sense fail
			Power fail
	Speaker enabled		GPIB installed
	Speaker disabled		GPIB installed & disabled
	Panel lock on		Connected to PC via USB
	Panel lock off		Connected to LAN
	Remote control mode		USB flash drive recognized

Note: Only the most common status bar icons are shown here. Please see the user manual for more information.

First Time Use Instructions

Use the following procedures when first using the PSB-1000 to power up the instrument, reset to the factory settings, view the system information and install the USB driver. Lastly, the How to Use the Instrument section will introduce you to the basic operating conventions used throughout the user manual. Please see the user manual for a more comprehensive first-time-use and safety information.

Power Up

1. Connect the power cord to the rear panel socket.
2. Press the POWER key. The splash screen will appear momentarily before the continuous mode screen appears with the settings loaded.

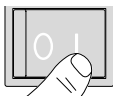

The power supply takes around 10 seconds to fully turn on and around half that time to shutdown.

Do not turn the power on and off quickly.

Reset to Factory Settings

The factory default settings can be restored from the Utility menu. See the user manual for a list of factory settings.

1. Press the  key. The utility menu will appear on the display.
2. Go to *Factory Setting* and press *Enter*.
3. Press *Restore*[F4] to restore the factory settings.
4. Press *OK* [F4] to confirm.

View System Information

The Utility>System Information setting displays the serial number and software version number.

1. Press the  key. The utility menu will appear on the display.
2. Use the scroll wheel to go to *System Information* and press *Enter*.
3. The system information should now be listed on the display.

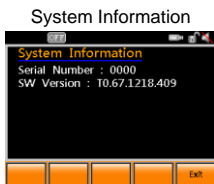

USB Driver Installation

If the USB Type B interface is to be used for remote control, the USB driver needs to be installed.



The USB driver, GW_PSB1k, is located on the CD-ROM that accompanied this user manual. Alternatively the driver can be downloaded from the GW Instek website.

1. Connect the rear panel USB-B port on the PSB-1000 to the PC using a USB Type A to B cable.
2. Go the Windows Device Manager
3. For Windows 7:

Start > Control Panel > Hardware and Sound > Device Manager.

The PSB-1000 will be located under *Other Devices* in the hardware tree. Right-click *PSB-1XXX* and choose *Update Driver Software*.

4. From the hardware wizard choose *Browse my computer driver software*.
5. Set the file path to the location of the USB driver, click *Next* and finish the driver installation.
6. The PSB-1000 will now be located in the *Ports* node of the hardware tree in the Windows Device Manager if the driver installation was successful.

How to Use the Instrument

The PSB-1000 power supplies generally use the scroll wheel, arrow keys, Enter keys and soft-menu function keys to edit numerical values or to select menu options.

The following section will explain some of these concepts in detail.

Soft menu keys

The F1 ~ F5 function keys at the bottom of the display correspond directly to soft-menu keys above. The soft-menu keys have a number of different functions, depending on the use-case. They can be used as quick-action keys, option keys or as submenus.

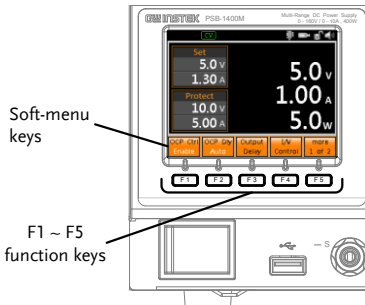

Menu Keys

Pressing a Menu key will enter the corresponding menu for that key.

Selecting Menu Items

1. Turn the scroll wheel to select parameters in menus and lists. The selected parameter will be highlighted in orange. The scroll wheel is also used to increment/decrement setting values.
2. Press the Enter key to edit the parameter or to enter the selected menu.



Example: The following is an example of the Function menu that appears when the FUNC key is pressed.



Navigating Menus one page at a time

1. For menus with more than 1 page of items, pressing the directional keys will allow you to jump to the next menu page.



Using the Keypad to edit parameter values

When editing a value the keypad can be used to directly enter the desired value.

1. Type the value of the parameter using the keypad.

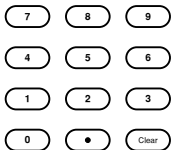

2. Press the Enter key to confirm the edit.



Example

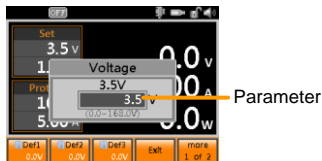

Using the Arrow Keys and Scroll wheel to edit parameter values

1. Use the arrow keys to move to the digit of the desired power (shown in blue).



2. Turn the scroll wheel to edit the value by the resolution of the selected digit.



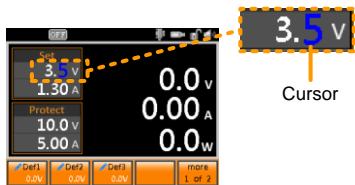

3. Repeat the steps above for all the relevant digits.
4. Press the Enter key to confirm the edit.



Using the onscreen keyboard

The onscreen keyboard is used for creating filenames, renaming files, and so on. The screenshot below is an example of the onscreen keyboard.

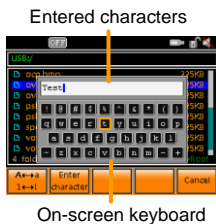

1. Use the scroll wheel to move the cursor to the desired character on the keyboard.
2. Press *Enter character* [F2] or the right arrow key to enter the desired character into the text entry area.



OR



3. Use the $A \leftrightarrow a$ / $1 \leftrightarrow !$ [F1] key to toggle the keyboard to lower case characters and other non-alphanumeric characters.



4. Use the left arrow key to delete the character to the left of the cursor.



5. Press Enter to finish using the keyboard.



SPECIFICATIONS

The following are the basic specifications for the PSB-1000. For detailed specifications, please see the user manual.

Output (400W models)

Model	PSB-1400L	PSB-1400M
Rated output voltage*	40V	160V
Rated output current*	40A	10A
Rated output power	400W	400W
Power Ratio	4	4

Constant Voltage Mode (400W models)

Model	PSB-1400L	PSB-1400M
Line regulation*	23mV	83mV
Load regulation*	25mV	85mV
Ripple and noise*	60mVp-p *	60mVp-p *

Constant Current Mode (400W models)

Model	PSB-1400L	PSB-1400M
Line regulation*	45mA	15mA
Load regulation*	45mA	15mA
Ripple and noise*	80mA	20mA

Output (800W models)

Model	PSB-1800L	PSB-1800M
Rated output voltage*	40V	160V
Rated output current*	80A	20A
Rated output power	800W	800W
Power Ratio	4	4

Constant Voltage Mode (800W models)

Model	PSB-1800L	PSB-1800M
Line regulation*	23mV	83mV
Load regulation*	25mV	85mV
Ripple and noise*	80mVp-p*	80mVp-p*

Constant Current Mode (800W models)

Model	PSB-1800L	PSB-1800M
Line regulation*	85mA	25mA
Load regulation*	85mA	25mA
Ripple and noise*	160mA	40mA

*Subject to limitations/conditions. Please see the user manual specifications for more details.

Declaration of Conformity

We

GOOD WILL INSTRUMENT CO., LTD.

No.7-1, Jhongsing Rd., Tucheng Dist., New Taipei City 236,
Taiwan

GOOD WILL INSTRUMENT (SUZHOU) CO., LTD.

No. 69, Lushan Road, Suzhou New District Jiangsu, China

declare that the below mentioned products

PSB-1400L, PSB-1400M, PSB-1800L, PSB-1800M

are herewith confirmed to comply with the requirements set out in the Council Directive on the Approximation of the Laws of the Member States relating to the Low Voltage Directive (2004/108/EC & 2014/30/EU) and Electromagnetic Compatibility (2006/95/EC & 2014/35/EU). For the evaluation regarding the Electromagnetic Compatibility and Low Voltage Equipment Directive, the following standards were applied:

◎ EMC

EN 61326-1:	Electrical equipment for measurement, control and laboratory use — EMC requirements (2013)	
EN 61326-2-1:		
Conducted & Radiated Emission EN 55011: 2009+A1:2010		Electrostatic Discharge EN 61000-4-2: 2009
Current Harmonics EN 61000-3-2: 2014		Radiated Immunity EN 61000-4-3: 2006 +A1:2008 +A2:2010
Voltage Fluctuations EN 61000-3-3: 2013		Electrical Fast Transients EN 61000-4-4: 2012
-----		Surge Immunity EN 61000-4-5: 2006
-----		Conducted Susceptibility EN 61000-4-6: 2014
-----		Power Frequency Magnetic Field EN 61000-4-8: 2010
-----		Voltage Dip/ Interruption EN 61000-4-11: 2004

◎ Safety

Low Voltage Equipment Directive 2006/95/EC and 2014/35/EU
Safety Requirements: EN 61010-1: 2010; EN 61010-2-030: 2010