

# Arbitrary Function Generator

AFG-125/AFG-225/AFG-125P/AFG-225P

---

## USER MANUAL

GW INSTEK PART NO. 82AF-12500E01



ISO-9001 CERTIFIED MANUFACTURER

**GW INSTEK**

This manual contains proprietary information, which is protected by copyright. All rights are reserved. No part of this manual may be photocopied, reproduced or translated to another language without prior written consent of Good Will Corporation.

The information in this manual was correct at the time of printing. However, Good Will continues to improve its products and therefore reserves the right to change the specifications, equipment, and maintenance procedures at any time without notice.

**Good Will Instrument Co., Ltd.**

**No. 7-1, Jhongsing Rd., Tucheng Dist., New Taipei City 236, Taiwan.**

# Table of Contents

<b>SAFETY INSTRUCTIONS</b> .....	<b>7</b>
Safety Symbols .....	7
Safety Guidelines.....	8
<b>GETTING STARTED</b> .....	<b>11</b>
Main Features .....	11
Panel Overview.....	13
Front Panel .....	13
Rear Panel.....	14
System Requirements.....	15
Software Installation .....	15
Setup the Signal Generator.....	16
Default Settings .....	17
<b>REMOTE INTERFACE</b> .....	<b>19</b>
Establishing a Remote Connection .....	19
Configure USB interface.....	19
Remote control terminal connection.....	20
Command Syntax .....	21
System Command .....	26
SYSTEM:ERRor? .....	26
*IDN? .....	26
*RST .....	27
SYSTEM:VERSion?.....	27
*OPC .....	27
*OPC? .....	28
*WAI .....	28
Status Register Commands .....	29
*CLS.....	29
*ESE.....	29
*ESR? .....	30
*STB? .....	30
*SRE .....	31
Apply Commands .....	32
SOURce[1 2]:APPLY:SINusoid.....	34
SOURce[1 2]:APPLY:SQUare .....	34
SOURce[1 2]:APPLY:RAMP.....	35

SOURce[1 2]:APPLY:PULSe .....	35
SOURce[1 2]:APPLY:NOISe.....	36
SOURce[1 2]:APPLY:USER .....	36
SOURce[1 2]:APPLY? .....	37
Output Commands .....	38
SOURce[1 2]:FUNCTion .....	38
SOURce[1 2]:FREQuency .....	39
SOURce[1 2]:AMPlitude.....	41
SOURce[1 2]:DCOffset.....	42
SOURce[1 2]:SQUare:DCYCLE.....	43
SOURce[1 2]:RAMP:SYMMetry.....	44
OUTPut[1 2] .....	45
OUTPut[1 2]:LOAD .....	45
SOURce[1 2]:VOLTage:UNIT .....	46
Pulse Configuration Commands .....	48
SOURce[1 2]:PULSe:PERiod .....	48
SOURce[1 2]:PULSe:WIDTh.....	49
Amplitude Modulation (AM) Commands .....	50
AM Overview.....	50
SOURce[1 2]:AM:STATe.....	51
SOURce[1 2]:AM:INTernal:FUNCTion .....	51
SOURce[1 2]:AM:INTernal:FREQuency.....	52
SOURce[1 2]:AM:DEPTh.....	52
Frequency Modulation (FM) Commands.....	54
FM Overview .....	54
SOURce[1 2]:FM:STATe.....	55
SOURce[1 2]:FM:INTernal:FUNCTion .....	55
SOURce[1 2]:FM:INTernal:FREQuency .....	56
SOURce[1 2]:FM:DEVIation .....	56
Frequency-Shift Keying (FSK) Commands .....	59
FSK Overview .....	59
SOURce[1 2]:FSKey:STATe.....	59
SOURce[1 2]:FSKey:FREQuency .....	60
SOURce[1 2]:FSKey:INTernal:RATE.....	61
Phase Modulation (PM) Commands .....	62
PM Overview.....	62
SOURce[1 2]:PM:STATe.....	63
SOURce[1 2]:PM:INTernal:FUNCTion .....	63
SOURce[1 2]:PM:INTernal:FREQuency .....	64
SOURce[1 2]:PM:DEVIation .....	64
SUM Modulation (SUM) Commands .....	66
SUM Overview .....	66
SOURce[1 2]:SUM:STATe.....	67

SOURCE[1 2]:SUM:INTernal:FUNction.....	67
SOURCE[1 2]:SUM:INTernal:FREQuency.....	68
SOURCE[1 2]:SUM:AMPL.....	68
Frequency Sweep Commands .....	70
Sweep Overview .....	70
SOURCE[1 2]:SWEep:STATe .....	71
SOURCE[1 2]:FREQuency:STARt .....	72
SOURCE[1 2]:FREQuency:STOP.....	72
SOURCE[1 2]:FREQuency:CENTer.....	73
SOURCE[1 2]:FREQuency:SPAN.....	74
SOURCE[1 2]:SWEep:SPACing.....	75
SOURCE[1 2]:SWEep:TIME.....	75
SOURCE[1 2]:SWEep:SOURce.....	76
SOURCE[1 2]:MARKer:FREQuency.....	77
SOURCE[1 2]:MARKer.....	77
Burst Mode Commands.....	79
Burst Mode Overview.....	79
SOURCE[1 2]:BURSt:STATe .....	81
SOURCE[1 2]:BURSt:MODE .....	81
SOURCE[1 2]:BURSt:NCYCles .....	82
SOURCE[1 2]:BURSt:INTernal:PERiod .....	83
SOURCE[1 2]:BURSt:PHASe .....	83
SOURCE[1 2]:BURSt:TRIGger:SOURce .....	84
SOURCE[1 2]:BURSt:TRIGger:DELay.....	85
SOURCE[1 2]:BURSt:TRIGger:SLOPe.....	86
SOURCE[1 2]:BURSt:GATE:POLarity.....	86
SOURCE[1 2]:BURSt:OUTPut:TRIGger:SLOPe .....	87
SOURCE[1 2]:BURSt:OUTPut[1 2]:TRIGger.....	88
Arbitrary Waveform Commands.....	89
Arbitrary Waveform Overview.....	89
SOURCE[1 2]:FUNCTion USER .....	90
SOURCE[1 2]:DATA:DAC .....	90
SOURCE[1 2]:ARB:EDIT:COpy .....	91
SOURCE[1 2]:ARB:EDIT:DELeTe .....	92
SOURCE[1 2]:ARB:EDIT:DELeTe:ALL .....	92
SOURCE[1 2]:ARB:EDIT:POINt.....	92
SOURCE[1 2]:ARB:EDIT:LINE.....	93
SOURCE[1 2]:ARB:EDIT:PROTeCt.....	93
SOURCE[1 2]:ARB:EDIT:PROTeCt:ALL .....	94
SOURCE[1 2]:ARB:EDIT:UNProTeCt.....	94
SOURCE[1 2]:ARB:OUTPut.....	94
Phase .....	95
SOURCE[1 2]:PHASe.....	95
SOURCE[1 2]:PHASe:SYNChronize.....	95

Couple .....	96
SOURce[1 2]:FREQuency:COUPle:MODE .....	96
SOURce[1 2]:FREQuency:COUPle:OFFSet .....	96
SOURce[1 2]:FREQuency:COUPle:RATio .....	97
SOURce[1 2]:AMPlitude:COUPle:STATe .....	97
SOURce[1 2]:TRACk .....	97
Sync .....	99
OUTPut:SYNC .....	99
OUTPut[1 2]:SYNC:MODE .....	99
OUTPut[1 2]:SYNC:POLarity .....	100
OUTPut:SYNC:SOURce .....	101
Power Commands .....	102
VOUTput .....	102
VSET .....	102
Save and Recall Commands .....	104
*SAV .....	104
*RCL .....	104
MEMory:STATe:DELeTe .....	104
MEMory:STATe:DELeTe ALL .....	105
Error Messages .....	106
Command Error Codes .....	106
Execution Errors .....	108
Query Errors .....	115
Arbitrary Waveform Errors .....	115
SCPI Status Register .....	117
Register types .....	117
AFG-200 SERIES Status System .....	118
Questionable Status Register .....	119
Standard Event Status Registers .....	119
The Status Byte Register .....	121
Output Queue .....	122
Error Queue .....	122
<b>APPDENIX.....</b>	<b>123</b>
AFG-200 Specifications .....	123







# SAFETY INSTRUCTIONS

This chapter contains important safety instructions that should be followed when operating and storing the function generator. Read the following before any operation to ensure your safety and to keep the function generator in the best condition.

## Safety Symbols

These safety symbols may appear in this manual or on the instrument.

---

	<b>WARNING</b>	Warning: Identifies conditions or practices that could result in injury or loss of life.
	<b>CAUTION</b>	Caution: Identifies conditions or practices that could result in damage to the function generator or to other objects or property.
	<b>DANGER</b>	High Voltage
	<b>Attention:</b>	Refer to the Manual
		Protective Conductor Terminal
		Earth (Ground) Terminal
	<b>DANGER</b>	Hot Surface



Double Insulated



Do not dispose electronic equipment as unsorted municipal waste. Please use a separate collection facility or contact the supplier from which this instrument was purchased.

## Safety Guidelines

---

General  
Guideline



CAUTION

- Do not place heavy objects on the instrument.
- Do not place flammable objects on the instrument.
- Avoid severe impact or rough handling that may damage the function generator.
- Avoid discharges of static electricity on or near the function generator.
- Use only mating connectors, not bare wires, for the terminals.
- The instrument should only be disassembled by a qualified technician.

Power Supply



WARNING

- DC Input voltage: 5V/2A.
- Do not exceed an input voltage of 5V±5%.

Fuse



WARNING

- Fuse type: F3.15A/125V.
- Only qualified technicians should replace the fuse.
- To ensure fire protection, replace the fuse only with the specified type and rating.
- Disconnect the power and all test leads before replacing the fuse.
- Make sure the cause of fuse blowout is fixed before replacing the fuse.



---

Cleaning the function generator	<ul style="list-style-type: none"> <li>• Disconnect the power cord before cleaning the function generator.</li> <li>• Use a soft cloth dampened in a solution of mild detergent and water. Do not spray any liquid into the function generator.</li> <li>• Do not use chemicals containing harsh products such as benzene, toluene, xylene, and acetone.</li> </ul>
<hr/>	
Operation Environment	<ul style="list-style-type: none"> <li>• Location: Indoor, no direct sunlight, dust free, almost non-conductive pollution (Note below) and avoid strong magnetic fields.</li> <li>• Relative Humidity: &lt; 80%</li> <li>• Altitude: &lt; 2000m</li> <li>• Temperature: 0°C to 40°C</li> </ul> <p>(Pollution Degree) EN 61010-1:2010 specifies pollution degrees and their requirements as follows. The function generator falls under degree 2.</p> <p>Pollution refers to “addition of foreign matter, solid, liquid, or gaseous (ionized gases), that may produce a reduction of dielectric strength or surface resistivity”.</p> <ul style="list-style-type: none"> <li>• Pollution degree 1: No pollution or only dry, non-conductive pollution occurs. The pollution has no influence.</li> <li>• Pollution degree 2: Normally only non-conductive pollution occurs. Occasionally, however, a temporary conductivity caused by condensation must be expected.</li> <li>• Pollution degree 3: Conductive pollution occurs, or dry, non-conductive pollution occurs which becomes conductive due to condensation which is expected. In such conditions, equipment is normally protected against exposure to direct sunlight, precipitation, and full wind pressure, but neither temperature nor humidity is controlled.</li> </ul>
<hr/>	
Storage environment	<ul style="list-style-type: none"> <li>• Location: Indoor</li> <li>• Relative Humidity: &lt; 70%</li> <li>• Temperature: -10°C ~ 70°C</li> </ul>
<hr/>	

## Disposal



Do not dispose this instrument as unsorted municipal waste. Please use a separate collection facility or contact the supplier from which this instrument was purchased. Please make sure discarded electrical waste is properly recycled to reduce environmental impact.

# GETTING STARTED

The Getting started chapter introduces the function generator's main features, appearance and introduces a quick instructional summary of some of the basic functions. For comprehensive operation instructions, please see the operation chapter.

## Main Features

Model	AFG-125	AFG-125P	AFG-225	AFG-225P
Frequency Range	1uHz-25MHz			
Output Channels	1	1	2	2
Power Output	None	Yes	None	Yes
Performance	<ul style="list-style-type: none"> <li>• DDS signal generator</li> <li>• 1<math>\mu</math>Hz resolution over the full range</li> <li>• 20ppm frequency stability</li> <li>• Arbitrary Waveform Capability</li> </ul>			
Features	120 MSa/s sample rate			
	60 MSa/s repetition rate			
Features	4 k-point waveform length			
	4k waveform memory, 10 groups			
Features	User-defined output			
	DWR (Direct waveform reconstruction) capability			
Features	PC waveform editing			
	<ul style="list-style-type: none"> <li>• Sine, Square, Ramp, Pulse &amp; Noise as standard waveforms</li> <li>• Internal LIN/LOG sweeps with marker output</li> <li>• AM, FM, FSK, SUM modulation</li> <li>• Triggered burst function</li> <li>• Save/recall 10 setup memories</li> <li>• Output overload protection</li> </ul>			

- |  |  |
|--|--|
| Interface                                | <ul style="list-style-type: none"><li>• USB interface as standard</li><li>• AWES (arbitrary waveform editing software) PC software</li></ul> |
| Power Supply<br>(AFG-125P/<br>225P only) | <ul style="list-style-type: none"><li>• 2.5V/3.3V/5V supply output</li><li>• 0.6A current output</li></ul>                                   |

# Panel Overview

## Front Panel

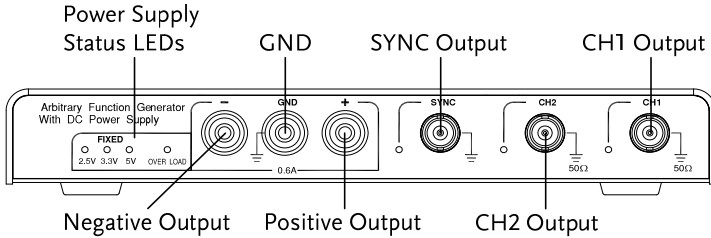

### Power Supply Status LEDs

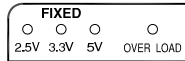

These LEDs indicate the immediate status of the power supply function on the AFG-125P/225P:

2.5V                      2.5V output is on

3.5V                      3.5V output is on

5V                        5V output is on

OVER LOAD            Overload condition

### Negative Output

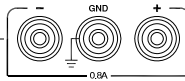

Negative output port

### GND

Ground port

### Positive Output

Positive output port

### SYNC

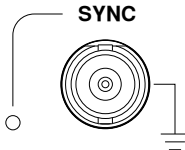

Sync output. A TTL signal is output as the sweep marker or sync output signal.

### CH1

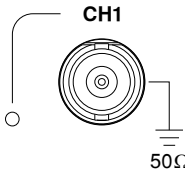

CH1 (Signal 1) output.

CH2

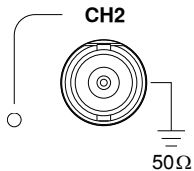

CH1 (Signal 2) output  
(AFG-225/ AFG-225P only).

### Rear Panel

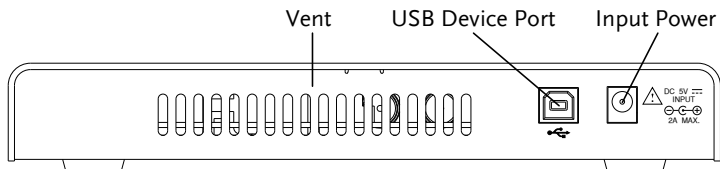

Vent

Cooling vent.

USB Device Port



Interfaces with the GDS-2000A and can also provide power.

Input Power

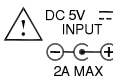

Input power source:  
DC 5V; 2A max.

## System Requirements

---

Operating System	Microsoft Windows XP Microsoft Windows 7 Microsoft Windows Vista
CPU	300MHz
Memory	256MB
Hard Disk Space	100MB
Supports	The USB 2.0 Universal Serial Bus specification is USB2.0(compatible supported with transfer rates from USB1.1 to with USB1.1) USB2.0.

## Software Installation

---

Close all the programs that are currently running.  
Insert the included installation CD into your CD-ROM drive, and execute the following steps:

1. Execute the installer on the CD. Install the software step by step by following the prompts.

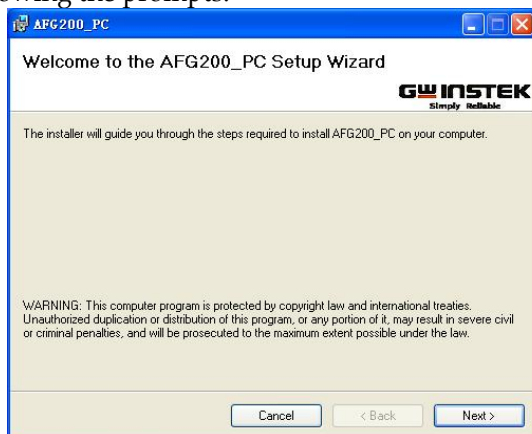

2. Connect hardware after the installation is completed. The computer will automatically search for the new hardware and install its driver. You can start to use the signal generator after the driver is installed.

## Setup the Signal Generator

PC Communication

1. Plug the power adapter into the power input port on the rear panel.
2. Connect the type B end of the accessory USB cable to the USB B port on the signal generator, and then connect the type A end of the USB cable to the USB A port on the computer.
3. Turn on the PC and control the signal generator through the PC software.

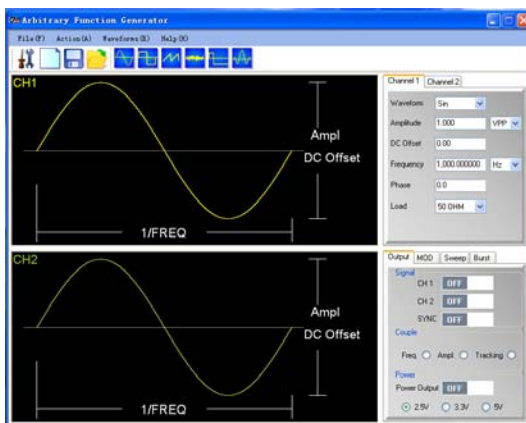

The signal generator is ready for use.



## Default Settings

The command \*RST is used to restore the default \*RST panel settings.

Output Settings	Function	Sine Wave
	Frequency	1kHz
	Amplitude	1.000 Vpp
	Offset	0.00V dc
	Output units	Vpp
	Output terminal	50Ω
	Power	OFF
	Sync	OFF

Modulation (AM/FM/FSK/ PM/SUM)	Carrier wave	1kHz sine wave
	Modulation wave	100Hz sine wave
	AM depth	100%
	FM deviation	100Hz
	FSK hop frequency	100Hz
	FSK frequency	10Hz
	PM phase deviation	180°
	SUM amplitude	50%
	Modem status	Off

Sweep	Start/Stop frequency	100Hz/1kHz
	Sweep time	1s
	Sweep type	Linear

	Sweep status	Off
Burst	Burst frequency	1kHz
	Ncycle	1
	Burst period	10ms
	Burst starting phase	0°
	Burst status	Off
System Settings	Power off signal	On
	Error queue	Cleared
	Memory settings	No change
	Output	Off

# REMOTE INTERFACE

Establishing a Remote Connection .....	19
Configure USB interface.....	19
Remote control terminal connection.....	20
Command Syntax .....	21

## Establishing a Remote Connection

The AFG-200 supports USB remote connections

### Configure USB interface

USB configuration	PC side connector	
	AFG-200 series side connector	Type B, slave
	Speed	1.1/2.0 (full speed)

- Panel Operation
1. Connect the USB cable to the rear panel USB B (slave) port.



2. When the PC asks for the USB driver, select XXXXXX.inf included in the software package or download the driver from the GW website, [www.gwinstek.com](http://www.gwinstek.com).

---

## Remote control terminal connection

---

Terminal application	<p>Invoke the terminal application such as MTTY (Multi-Threaded TTY). For USB, set the COM port, baud rate, stop bit, data bit, and parity accordingly.</p> <p>To check the COM port No, see the Device Manager in the PC. For WinXP, Control panel → System → Hardware tab.</p>
Functionality check	<p>Run this query command via the terminal.</p> <pre>*!dn?</pre> <p>This should return the Manufacturer, Model number, Serial number, and Firmware version in the following format.</p> <pre>GW INSTEK, AFG-X25X, SN:XXXXXXXX, Vm.mm</pre> <p>Note: ^j or ^m can be used as the terminal character when using a terminal program.</p>
PC Software	<p>The proprietary PC software, downloadable from GWInstek website, can be used for remote control.</p>

## Command Syntax

Compatible standard	<ul style="list-style-type: none"> <li>• IEEE488.2, 1992 (fully compatible)</li> <li>• SCPI, 1994 (partially compatible)</li> </ul>
Command Tree	The SCPI standard is an ASCII based standard that defines the command syntax and structure for programmable instruments.

Commands are based on a hierarchical tree structure. Each command keyword is a node on the command tree with the first keyword as the root node. Each sub node is separated with a colon.

Shown below is a section of the `SOURce[1|2]` root node and the `:PM` and `:PULSe` sub nodes.

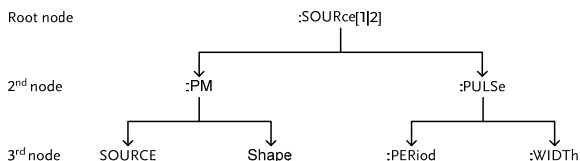

Command types	Commands can be separated in to three distinct types, simple commands, compound commands and queries.
Simple	A single command with/without a parameter
Example	*OPC
Compound	Two or more commands separated by a colon (:) with/without a parameter
Example	SOURce1:PULSe:WIDTh

Query	A query is a simple or compound command followed by a question mark (?). A parameter (data) is returned. The maximum or minimum value for a parameter can also be queried where applicable.
Example	SOURce1:FREQuency? SOURce1:FREQuency? MIN

**Command forms** Commands and queries have two different forms, long and short. The command syntax is written with the short form of the command in capitals and the remainder (long form) in lower case.

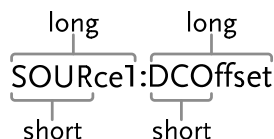

The commands can be written in capitals or lower-case, just so long as the short or long forms are complete. An incomplete command will not be recognized.

Below are examples of correctly written commands:

LONG SOURce1:DCOffset  
 SOURCE1:DCOFFSET  
 source1:dcoffset

SHORT SOUR1:DCO  
 sour1:dco

Command Format	$\underbrace{\text{SOURCE1:DCOffset}}_1 \underbrace{\langle \text{offset} \rangle}_{2} \underbrace{\text{LF}}_4$	<p>1: command header</p> <p>2: single space</p> <p>3: parameter</p> <p>4: message terminator</p>
-------------------	--	--

**Square Brackets []** Commands that contain squares brackets indicate that the contents are optional. The function of the command is the same with or without the square bracketed items. Brackets are not sent with the command.

For example, the frequency query below can use any of the following 3 forms:

SOURCE1:FREQUENCY? [MINimum|MAXimum]

SOURCE1:FREQUENCY? MAXimum

SOURCE1:FREQUENCY? MINimum

SOURCE1:FREQUENCY?

**Braces {}** Commands that contain braces indicate one item within the braces must be chosen. Braces are not sent with the command.

**Angled Brackets <>** Angle brackets are used to indicate that a value must be specified for the parameter. See the parameter description below for details. Angled brackets are not sent with the command.

**Bars |** Bars are used to separate multiple parameter choices in the command format.

Parameters	Type	Description	Example
	<Boolean>	Boolean logic	0, 1/ON,OFF
	<NR1>	integers	0, 1, 2, 3
	<NR2>	decimal numbers	0.1, 3.14, 8.5
	<NR3>	floating point	4.5e-1, 8.25e+1
	<NRf>	any of NR1, 2, 3	1, 1.5, 4.5e-1

<NRf+> <Numeric>	NRf type with a suffix including MINimum, MAXimum or DEFault parameters.	1, 1.5, 4.5e-1 MAX, MIN,
<aard>	Arbitrary ASCII characters.	
<discrete>	Discrete ASCII character parameters	IMM, MAN
<frequency> <peak deviation in Hz> <rate in Hz>	NRf+ type including frequency unit suffixes.	1 KHZ, 1.0 HZ, MHZ
<amplitude>	NRf+ type including voltage peak to peak.	VPP
<offset>	NRf+ type including volt unit suffixes.	V
<seconds>	NRf+ type including time unit suffixes.	NS, S MS US
<percent> <depth in percent>	NRf type	N/A

Message terminators

LF CR	line feed code (new line) and carriage return.
LF	line feed code (new line)
EOI	IEEE-488 EOI (End-Or-Identify)

 Note

^j or ^m should be used when using a terminal program.



Command Separators	Space	A space is used to separate a parameter from a keyword/command header.
	Colon (:)	A colon is used to separate keywords on each node.
	Semicolon (;)	A semi colon is used to separate subcommands that have the same node level.  For example: SOURce[1 2]:DCOffset? SOURce[1 2]:OUTPut? →SOURce1:DCOffset?;OUTPut?
Colon + Semicolon (;:)	A colon and semicolon can be used to combine commands from different node levels.  For example: SOURce1:PM:SOURce? SOURce:PULSe:WIDTh? →SOURce1:PM:SOURce?;;SOURce:PULSe:WIDTh?	
Comma (,)	When a command uses multiple parameters, a comma is used to separate the parameters.  For example: SOURce:APPLy:SQUare 10KHZ, 2.0 VPP, -1V	

## System Command

### SYSTem:ERRor?

System Query

**Description** Reads an error from the error queue. See page 122 for details regarding the error queue.

**Query Syntax** **SYSTem:ERRor?**

**Return parameter** <string> Returns an error string, <256 ASCII characters.

**Example** **SYSTem:ERRor?**  
**-138 Suffix not allowed**  
 Returns an error string.

### \*IDN?

System Query

**Description** Returns the function generator manufacturer, model number, serial number and firmware version number in the following format:  
 GW INSTEK,AFG-X25X,SN:XXXXXXXX,Vm.mm

**Query Syntax** **\*IDN?**

**Return parameter** <string>

**Example** **\*IDN?**  
 GW INSTEK,AFG-225,SN:XXXXXXXX,Vm.mm  
 Returns the identification of the function generator.

---

**\*RST** System Command

---

Description	Reset the function generator to its factory default state.
-------------	--

Note	Note the *RST command will not delete instrument save states in memory.
------	---

Syntax	<b>*RST</b>
--------	-------------

---

**SYSTEM:VERSion?** System Query

---

Description	Performs a system version query. Returns a string with the instrument, firmware version, FPGA revision
-------------	--

Query Syntax	<b>SYSTEM:VERSion?</b>
--------------	------------------------

Return parameter	<string>
------------------	----------

Example	<b>SYST:VERS?</b> AFG-225 VX.XXX_XXXX Returns the year and version for that year (1).
---------	---

---

**\*OPC** System Command

---

Description	This command sets the Operation Complete Bit (bit 0) of the Standard Event Status Register after the function generator has completed all pending operations. For the AFG-200 series, the *OPC command is used to indicate when a sweep or burst has completed.
-------------	---

Note	Before the OPC bit is set, other commands may be executed.
------	--

Syntax	<b>*OPC</b>
--------	-------------

**\*OPC?**

## System Query

---

Description	Returns the OPC bit to the output buffer when all pending operations have completed. I.e. when the OPC bit is set.
-------------	--

---

Note	Commands cannot be executed until the *OPC? query has completed.
------	--

---

Query Syntax	<b>*OPC?</b>
--------------	--------------

---

Return parameter	1
------------------	---

---

Example	<b>*OPC?</b> <b>1</b> Returns a "1" when all pending operations are complete.
---------	---

**\*WAI**

## System Command

---

Description	This command waits until all pending operations have completed before executing additional commands. I.e., when the OPC bit is set.
-------------	---

---

Note	This command is only used for triggered sweep and burst modes.
------	--

---

Syntax	<b>*WAI</b>
--------	-------------

---

## Status Register Commands

**\*CLS** System Command

**Description**      The \*CLS command clears all the event registers, the error queue and cancels an \*OPC command.

**Syntax**            **\*CLS**

**\*ESE** System Command

**Description**      The Standard Event Status Enable command determines which events in the Standard Event Status Event register can set the Event Summary Bit (ESB) of the Status Byte register. Any bit positions set to 1 enable the corresponding event. Any enabled events set bit 5 (ESB) of the Status Byte register.

**Note**                The \*CLS command clears the event register, but not the enable register.

**Syntax**            **\*ESE <enable value>**

**Parameter**        <enable value>                      0~255

**Example**            **\*ESE 20**  
Sets a bit weight of 20 (bits 2 and 4).

**Query Syntax**    **\*ESE?**

Return Parameter	Bit	Register	Bit	Register
	0	Not used	4	Message Available
	1	Not used	5	Standard Event
	2	Error Queue	6	Master Summary
	3	Questionable Data	7	Not used

Example            **\*ESE?**  
                       **4**  
                       Bit 2 is set.

**\*ESR?** System Command

---

Description       Reads and clears the Standard Event Status Register. The bit weight of the standard event status register is returned.

---

Note                The \*CLS will also clear the standard event status register.

---

Query Syntax      **\*ESR?**

---

Return Parameter	Bit	Register	Bit	Register
	0	Operation Complete	4	Execution Error
	1	Not Used	5	Command Error
	2	Query Error	6	Not Used
	3	Device Error	7	Power On

---

Query Example    **\*ESR?**  
                       **5**  
                       Returns the bit weight of the standard event status register (bit 0 and 2).

**\*STB?** System Command

---

Description       Reads the Status byte condition register.

---

Note                Bit 6, the master summary bit, is not cleared.

---

Syntax             **\*STB?**

---

**\*SRE** System Command

**Description**      The Service Request Enable Command determines which events in the Status Byte Register are allowed to set the MSS (Master summary bit). Any bit that is set to “1” can cause the MSS bit to be set.

**Note**                The \*CLS command clears the status byte event register, but not the enable register.

**Syntax**            **\*SRE <enable value>**

**Parameter**        <enable value>      0~255

**Example**            **\*SRE 12**  
  
Sets a bit weight of 12 (bits 2 and 3) for the service request enable register.

**Query Syntax**    **\*SRE?**

Return Parameter	Bit	Register	Bit	Register
	0	Not used	4	Message Available
	1	Not used	5	Standard Event
	2	Error Queue	6	Master Summary
	3	Questionable Data	7	Not used

**Query Example**    **\*SRE?**  
  
**12**  
  
Returns the bit weight of the status byte enable register.

## Apply Commands

---

The APPLy command has 5 different types of outputs (Sine, Square, Ramp, Pulse, Noise, ). The command is the quickest, easiest way to output waveforms remotely. Frequency, amplitude and offset can be specified for each function.

As only basic parameters can be set with the Apply command, other parameters use the instrument default values.

The Apply command will set the trigger source to immediate and disable burst, modulation and sweep modes. Turns on the output commandOUTPut[1 | 2] ON. The termination setting will not be changed.

As the frequency, amplitude and offset parameters are in nested square brackets, amplitude can only be specified if the frequency has been specified and offset can only be specified if amplitude has been set. For the example:

```
SOURce[1 | 2]:APPLy:SINusoid [<frequency> [,<amplitude>
[,<offset>] ]]
```

**Output Frequency** For the output frequency, MINimum, MAXimum and DEFault can be used. The default frequency for all functions is set to 1 kHz. The maximum and minimum frequency depends on the function used. If a frequency output that is out of range is specified, the max/min frequency will be used instead. A "Data out range error will be generated" from the remote terminal.

---



Output  
Amplitude

When setting the amplitude, MINimum, MAXimum and DEFault can be used. The range depends on the function being used and the output termination (50Ω or high impedance). The default amplitude for all functions is 100 mVpp (50Ω).

If the amplitude has been set and the output termination is changed from 50Ω to high impedance, the amplitude will double. Changing the output termination from high impedance to 50Ω will half the amplitude.

Vrms, dBm or Vpp units can be used to specify the output unit to use with the current command. The VOLT:UNIT command can be used to set the units when no unit is specified with the Apply command. If the output termination is set to high impedance, dBm units cannot be used. The units will default to Vpp.

The output amplitude can be affected by the function and unit chosen. Vpp and Vrms or dBm values may have different maximum values due to differences such as crest factor. For example, a 5Vrms square wave must be adjusted to 3.536 Vrms for a sine wave.

---

DC Offset voltage The offset parameter can be set to MINimum, MAXimum or DEFault. The default offset is 0 volts. The offset is limited by the output amplitude as shown below.

$$|V_{offset}| < V_{max} - V_{pp}/2$$

If the output specified is out of range, the maximum offset will be set.

The offset is also determined by the output termination (50Ω or high impedance). If the offset has been set and the output termination has changed from 50Ω to high impedance, the offset will double. Changing the output termination from high impedance to 50Ω will half the offset.

**SOURce[1|2]:APPLy:SINusoid** Source Specific Command

---

Description	Outputs a sine wave from the selected channel when the command has executed. Frequency, amplitude and offset can also be set.	
Syntax	SOURce[1 2]:APPLy:SINusoid [<frequency> [,<amplitude> [,<offset>] ]]	
Parameter	<frequency>	1μHz~25MHz
	<amplitude>	1mVpp~2.5Vpp (50Ω) (0.883 Vrms)
	<offset>	-1.25V~1.25V (50Ω)
Example	<b>SOUR1:APPL:SIN 2KHZ,MAX,MAX</b>  Sets frequency to 2kHz and sets the amplitude and offset to the maximum.	

**SOURce[1|2]:APPLy:SQUare** Source Specific Command

---

Description	Outputs a square wave from the selected channel when the command has executed. Frequency, amplitude and offset can also be set. The duty cycle is set to 50%.	
Syntax	SOURce[1 2]:APPLy:SQUare [<frequency> [,<amplitude> [,<offset>] ]]	
Parameter	<frequency>	1μHz~25MHz
	<amplitude>	1mVpp~2.5Vpp (50Ω)
	<offset>	-1.25V~1.25V (50Ω)
Example	<b>SOUR1:APPL:SQU 2KHZ,MAX,MAX</b>	

Sets frequency to 2kHz and sets the amplitude and offset to the maximum.

**SOURce[1|2]:APPLy:RAMP** Source Specific Command

---

**Description** Outputs a ramp wave from the selected channel when the command has executed. Frequency, amplitude and offset can also be set. The symmetry is set to 50%.

**Syntax** **SOURce[1|2]:APPLy:RAMP [<frequency> [,<amplitude> [,<offset>] ]]**

<b>Parameter</b>	<frequency>	1μHz~1MHz
	<amplitude>	1mVpp~2.5Vpp (50Ω)
	<offset>	-1.25V~1.25V (50Ω)

**Example** **SOUR1:APPL:RAMP 2KHZ,MAX,MAX**

Sets frequency to 2kHz and sets the amplitude and offset to the maximum.

**SOURce[1|2]:APPLy:PULSe** Source Specific Command

---

**Description** Outputs a pulse waveform from the selected channel when the command has executed. Frequency, amplitude and offset can also be set.

**Note** The PW settings from the SOURce[1|2]:PULS:WIDT command are preserved. Edge and pulse width may be adjusted to supported levels. Repetition rates will be approximated from the frequency. For accurate repetition rates, the period should be adjusted using the SOURce[1|2]:PULS:PER command

**Syntax** **SOUR[1|2]:APPLy:PULSe [<frequency> [,<amplitude> [,<offset>] ]]**

<b>Parameter</b>	<frequency>	500μHz~25MHz
------------------	-------------	--------------

<amplitude>	1mVpp~2.5Vpp (50Ω)
<offset>	-1.25V~1.25V (50Ω)

**Example**                    **SOUR1:APPL:PULS 1KHZ,MIN,MAX**

Sets frequency to 1kHz and sets the amplitude to minimum and the    and offset to the maximum.

**SOURce[1|2]:APPLy:NOISe** Source Specific Command

**Description**            Outputs Gaussian noise. Amplitude and offset can also be set.

**Note**                    Frequency cannot be used with the noise function; however a value (or DEFault) must be specified. The frequency is remembered for the next function used.

**Syntax**                **SOURce[1|2]:APPLy:NOISe [<frequency|DEFault> [,<amplitude> [,<offset>] ]]**

<b>Parameter</b>	<frequency>	Not applicable
	<amplitude>	1mVpp~2.5Vpp (50Ω)
	<offset>	-1.25V~1.25V (50Ω)

**Example**                    **SOUR1:APPL:NOIS DEF, 1, 1.0**

Sets the amplitude to 1 volts with an offset of 1 volt.

**SOURce[1|2]:APPLy:USER** Source Specific Command

**Description**            Outputs an arbitrary waveform from the selected channel. The output is that specified from the FUNC:USER command.

**Note**                    Frequency and amplitude cannot be used with the DC function; however a value (or DEFault) must be specified. The values are remembered for the next function used.

Syntax                    **SOURce[1|2]:APPLY:USER [<frequency> [,<amplitude> [,<offset>] ]]**

Parameter	<frequency>	1μHz~60MHz
	<amplitude>	1mVpp~2.5Vpp (50Ω)
	<offset>	-1.25V~1.25V (50Ω)

Example                    **SOUR1:APPL:USER**

**SOURce[1|2]:APPLY?** Source Specific Command

---

Description              Outputs a string with the current settings.

Note                        The string can be passed back appended to the Apply Command.

Syntax                    **SOURce[1|2]:APPLY?**

Return Parameter	<string>	Function, frequency, amplitude, offset
------------------	----------	--

Example                    **SOUR1:APPL?**  
 SIN +5.000000000000E+03,+1.0000E+00,-1.0E+00  
 Returns a string with the current function and parameters, Sine, 5kHz, 1 Vpp, -1V offset.

## Output Commands

---

Unlike the Apply commands, the Output commands are low level commands to program the function generator.

This section describes the low-level commands used to program the function generator. Although the APPLY command provides the most straightforward method to program the function generator, the low-level commands give you more flexibility to change individual parameters.

	Source Specific Command
<b>SOURce[1 2]:FUNCTION</b>	
Description	The FUNCTION command selects and outputs the selected output. The User parameter outputs an arbitrary waveform previously set by the SOURce[1 2]:FUNC:USER command.
Note	<p>If the function mode is changed and the current frequency setting is not supported by the new mode, the frequency setting will be altered to next highest value.</p> <p>Vpp and Vrms or dBm amplitude values may have different maximum values due to differences such as crest factor. For example, if a 5Vrms square wave is changed to a sinewave, then the Vrms is automatically adjusted to 3.536.</p> <p>The modulation, burst and sweep modes can only be used with some of the basic waveforms. If a mode is not supported, the conflicting mode will be disabled. See the table below.</p>

	Sine	Square	Ramp	Pulse	Noise	ARB
AM	✓	✓	✓	✓	×	✓
FM	✓	✓	✓	×	×	×
PM	✓	✓	✓	×	×	×
FSK	✓	✓	✓	✓	×	×
SUM	✓	✓	✓	✓	✓	×
SWEEP	✓	✓	✓	×	×	×
BURST	✓	✓	✓	×	×	✓

Syntax **SOURce[1|2]:FUNCtion {SINusoid|SQUare|RAMP|PULSe|NOISe| USER}**

Example **SOUR1:FUNC SIN**  
Sets the output as a sine function.

Query Syntax **SOURce[1|2]:FUNCtion?**

Return Parameter SIN, SQU, RAMP, PULS, NOIS, USER Returns the current output type.

Example **SOUR1:FUNC?**  
SIN  
Current output is sine.

**SOURce[1|2]:FREQuency** Source Specific Command

Description The SOURce[1 | 2]:FREQuency command sets the output frequency for the selected channel. The query command returns the current frequency setting.

Note The maximum and minimum frequency depends on the function mode.

Sine, Square	1μHz~25MHz
Ramp	1μHz~1MHz
Pulse	500μHz~25MHz

Noise	Not applicable
User	1μHz~60MHz

If the function mode is changed and the current frequency setting is not supported by the new mode, the frequency setting will be altered to next highest value.

The duty cycle of square waveforms depends on the frequency settings.

1.0% to 99.0% (*frequency* ≤ 100 KHz)

10% to 90% ( $100\text{ KHz} \leq \textit{frequency} \leq 1\text{MHz}$ )

50% (*frequency* ≤ 25 MHz)

If the frequency is changed and the set duty cycle cannot support the new frequency, the highest duty cycle available at that frequency will be used. A “settings conflict” error will result from the above scenario.

Syntax	<b>SOURce[1 2]:FREQuency {&lt;frequency&gt; MINimum MAXimum}</b>
--------	--

Example	<b>SOUR1:FREQ MAX</b> Sets the frequency to the maximum for the current mode.
---------	--

Query Syntax	<b>SOURce[1 2]:FREQuency?</b>
--------------	-------------------------------

Return Parameter	<NR3>	Returns the frequency for the current mode.
------------------	-------	---

Example	<b>SOUR1:FREQ? MAX</b> +1.0000000000000E+06 The maximum frequency that can be set for the current function is 1MHz.
---------	---



SOURCE[1 2]:AMPLitude	Source Specific Command
Description	<p>The SOURCE[1 2]:AMPLitude command sets the output amplitude for the selected channel. The query command returns the current amplitude settings.</p>
Note	<p>The maximum and minimum amplitude depends on the output termination. The default amplitude for all functions is 100 mVpp (50Ω). If the amplitude has been set and the output termination is changed from 50Ω to high impedance, the amplitude will double. Changing the output termination from high impedance to 50Ω will half the amplitude.</p> <p>The offset and amplitude are related by the following equation.</p> $ V_{offset}  < V_{max} - V_{pp}/2$ <p>If the output termination is set to high impedance, dBm units cannot be used. The units will default to Vpp.</p> <p>The output amplitude can be affected by the function and unit chosen. Vpp and Vrms or dBm values may have different maximum values due to differences such as crest factor. For example, a 5Vrms square wave must be adjusted to 3.536 Vrms for a sine wave.</p> <p>The amplitude units can be explicitly used each time the SOURCE[1 2]:AMPLitude command is used. Alternatively, the VOLT:UNIT command can be used to set the amplitude units for all commands.</p>

Syntax	<b>SOURce[1 2]:AMPLitude {&lt; amplitude&gt;  MINimum MAXimum}</b>	
Example	<b>SOUR1:AMP MAX</b> Sets the amplitude to the maximum for the current mode.	
Query Syntax	<b>SOURce[1 2]:AMPLitude? {MINimum MAXimum}</b>	
Return Parameter	<NR3>	Returns the amplitude for the current mode.
Example	<b>SOUR1:AMP? MAX</b> +2.5000E+00 The maximum amplitude that can be set for the current function is 2.5 volts.	

**SOURce[1|2]:DCOffset** Source Specific Command

---

**Description** Sets or queries the DC offset for the current mode.

**Note** The offset parameter can be set to MINimum, MAXimum or DEFault. The default offset is 0 volts. The offset is limited by the output amplitude as shown below.

$$|V_{offset}| < V_{max} - V_{pp}/2$$

If the output specified is out of range, the maximum offset will be set.

The offset is also determined by the output termination (50Ω or high impedance). If the offset has been set and the output termination has changed from 50Ω to high impedance, the offset will double. Changing the output termination from high impedance to 50Ω will half the offset.

Syntax	<b>SOURce[1 2]:DCOffset {&lt; offset&gt;  MINimum MAXimum}</b>	
Example	<b>SOUR1:DCO MAX</b> Sets the offset to the maximum for the current mode.	
Query Syntax	<b>SOURce[1 2]:DCOffset? {MINimum MAXimum}</b>	
Return Parameter	<NR3>	Returns the offset for the current mode.
Example	<b>SOUR1:DCO?</b> +1.0000E+00 The offset for the current mode is set to +1 volts.	

**SOURce[1|2]:SQUare:DCYCLE** Source Specific Command

Description	Sets or queries the duty cycle for square waves only. The setting is remembered if the function mode is changed. The default duty cycle is 50%.	
Note	<p>The duty cycle of square waveforms depend on the frequency settings.</p> <p>1.0% to 99.0% (<i>frequency</i> ≤ 100 KHz)</p> <p>10% to 90% (<math>100 \text{ KHz} \leq \textit{frequency} \leq 1\text{MHz}</math>)</p> <p>50% (<i>frequency</i> ≤ 25 MHz)</p> <p>If the frequency is changed and the set duty cycle cannot support the new frequency, the highest duty cycle available at that frequency will be used. A “settings conflict” error will result from the above scenario.</p> <p>For square waveforms, the Apply command and AM/FM modulation modes ignore the duty cycle settings.</p>	
Syntax	<b>SOURce[1 2]:SQUare:DCYCLE {&lt; percent&gt;  MINimum MAXimum}</b>	

Example	<b>SOUR1:SQU:DCYC MAX</b> Sets the duty cycle to the highest possible for the current frequency.
Query Syntax	<b>SOURce[1 2]:SQUare:DCYCLE? {MINimum MAXimum}</b>
Return Parameter	<NR3> Returns the duty cycle as a percentage.
Example	<b>SOUR1:SQU:DCYC?</b> +5.00E+01 The duty cycle is set 50%.

**SOURce[1|2]:RAMP:SYMMetry** Source Specific Command

---

Description	Sets or queries the symmetry for ramp waves only. The setting is remembered if the function mode is changed. The default symmetry is 50%.
Note	For ramp waveforms, the Apply command and AM/FM modulation modes ignore the current symmetry settings.
Syntax	<b>SOURce[1 2]:RAMP:SYMMetry {&lt; percent&gt;  MINimum MAXimum}</b>
Example	<b>SOUR1:RAMP:SYMM MAX</b> Sets the symmetry to the 100%.
Query Syntax	<b>SOURce[1 2]:RAMP:SYMMetry? {MINimum MAXimum}</b>
Return Parameter	<NR3> Returns the symmetry as a percentage.
Example	<b>SOUR1:RAMP:SYMMetry?</b> +1.0000E+02 The symmetry is set as 100%.

OUTPut[1 2]		Source Specific Command
Description	Enables/Disables or queries the front panel output from the selected channel. The default is set to off.	
Note	<p>If the output is overloaded by an external voltage, the output will turn off and an error message will be displayed. The overload must first be removed before the output can be turned on again with output command.</p> <p>Using the Apply command automatically sets the front panel output to on.</p>	
Syntax	<b>OUTPut[1 2] {OFF ON}</b>	
Example	<b>OUTP1 ON</b> Turns the channel 1 output on.	
Query Syntax	<b>OUTPut[1 2]?</b>	
Return Parameter	1	ON
	0	OFF
Example	<p><b>OUTP1?</b></p> <p>1</p> <p>The channel 1 output is currently on.</p>	

OUTPut[1 2]:LOAD		Source Specific Command
Description	<p>Sets or queries the output termination. Two impedance settings can be chosen, DEFault (50Ω) and INFinity (high impedance &gt;10 kΩ).</p> <p>The output termination is to be used as a reference only. If the output termination is set 50Ω but the actual load impedance is not 50Ω, then the amplitude and offset will not be correct.</p>	
Note	If the amplitude has been set and the output termination is changed from 50Ω to high	

impedance, the amplitude will double. Changing the output termination from high impedance to 50Ω will half the amplitude.

If the output termination is set to high impedance, dBm units cannot be used. The units will default to Vpp.

Syntax **OUTPut[1|2]:LOAD {DEFault|INFinity}**

Example **OUTP1:LOAD DEF**

Sets the channel 1 output termination to 50Ω.

Query Syntax **OUTPut[1|2]:LOAD?**

Return Parameter	DEF	Default
	INF	INFinity

Example **OUTP1:LOAD?  
DEF**

The output termination for channel 1 is set to 50Ω.

**SOURce[1|2]:VOLTage:UNIT** Source Specific Command

Description Sets or queries the output amplitude units. There are three types of units: VPP, VRMS and DBM.

Note The units set with the VOLTage:UNIT command will be used as the default unit for all amplitude units unless a different unit is specifically used for a command.

If the output termination is set to high impedance, dBm units cannot be used. The Units will automatically default to Vpp.

Syntax **SOURce[1|2]:VOLTage:UNIT {VPP|VRMS|DBM}**

Example **SOUR1:VOLT:UNIT VPP**

Sets the amplitude units to Vpp.

Query Syntax **SOURce[1|2]:VOLTage:UNIT?**

Return Parameter	VPP	Vpp
------------------	-----	-----

VRMS	Vrms
DBM	dBm

---

Example

**SOUR1:VOLT:UNIT?**

VPP

The amplitude units are set to Vpp.

## Pulse Configuration Commands

The pulse chapter is used to control and output pulse waveforms. Unlike the APPLY command, low level control is possible including setting the rise time, fall time, period and pulse width.

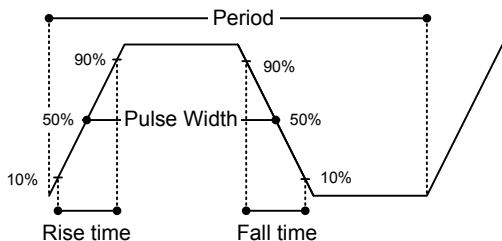

	Source Specific Command
<b>SOURce[1 2]:PULSe:PERiod</b>	<b>Source Specific Command</b>
<b>Description</b>	Sets or queries the pulse period. The default period is 1 ms.
<b>Note</b>	<p>The pulse period must be greater than the pulse width and edge time(1.6x) combined.</p> <p><math>Pulse\ Width + (1.6 * Edge\ Time) &lt; Period</math></p> <p>If the edge time or pulse width are too great, they will automatically be reduced to fit the period by the function generator.</p> <p>The PULSe:PERiod function will change the period for all functions, not just for the pulse waveforms. If a different function is chosen and the current period is out of range, the period will be automatically adjusted to suit the new function.</p>
<b>Syntax</b>	<b>SOURce[1 2]:PULSe:PERiod {&lt;seconds&gt; MINimum MAXimum}</b>
<b>Example</b>	<p><b>SOUR1:PULS:PER MIN</b></p> <p>Sets the period to the minimum time allowed.</p>
<b>Query Syntax</b>	<b>SOURce[1 2]:PULSe:PERiod? [MINimum MAXimum]</b>



Return Parameter	<seconds>	40ns~2000s
Example	<b>SOUR1:PULS:PER?</b> +1.0000E+01 The period is set to 10 seconds.	

<b>SOURce[1 2]:PULSe:WIDTh</b>	Source Specific Command
--------------------------------	-------------------------

---

Description	Sets or queries the pulse width. The default pulse width is 100us.  The minimum pulse width is affected by the period time. If the period is over 20 or 200 seconds, then the minimum pulse width is 1us and 10us, respectively.  Pulse width is defined as the time from the rising to falling edges (at a threshold of 50%).
-------------	--

Note	The pulse width cannot be less than the edge time times 1.6.  $Pulse\ Width > 1.6 * Edge\ Time$  The pulse width must be less than the period minus the edge time (x1.6).  $Pulse\ Width < Period - (1.6 * Edge\ Time)$
------	---

Syntax	<b>SOURce[1 2]:PULSe:WIDTh</b> <b>{&lt;seconds&gt; MINimum MAXimum}</b>
--------	--

Example	<b>SOUR1:PULS:WIDTh MAX</b>  Sets the pulse width to the maximum allowed.
---------	---

Query Syntax	<b>SOURce[1 2]:PULSe:WIDTh? [MINimum MAXimum]</b>
--------------	---

Return Parameter	<seconds>	20 ns ~ 1999.9 seconds
------------------	-----------	------------------------

Example	<b>SOUR1:PULS:WIDTh? MIN</b> +8.0000E-09 The pulse width is set to 8 nanoseconds.	
---------	---	--

# Amplitude Modulation (AM) Commands

## AM Overview

---

To successfully create an AM waveform, the following commands must be executed in order.

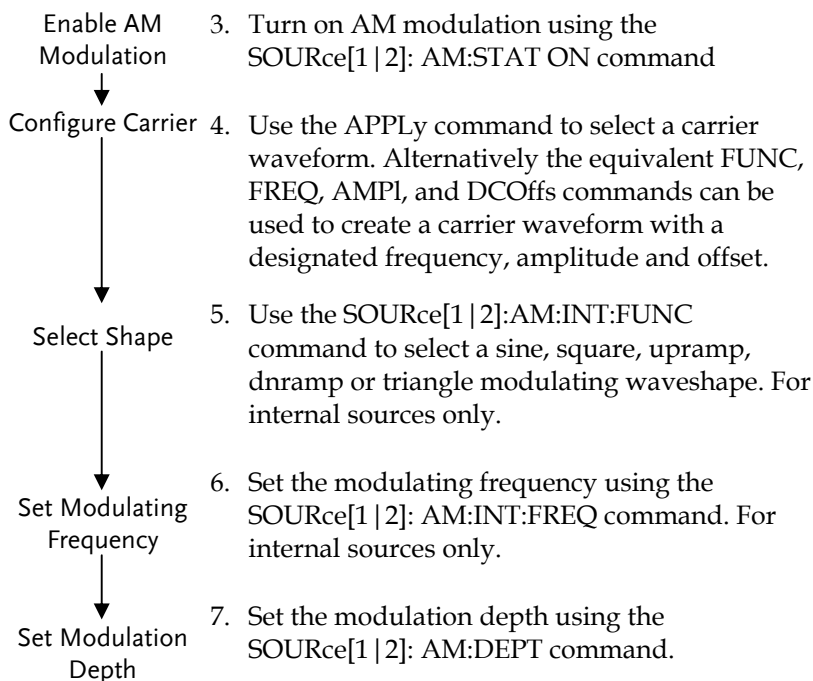

<b>SOURce[1 2]:AM:STATe</b>		Source Specific Command
Description	Sets or disables AM modulation. By default AM modulation is disabled. AM modulation must be enabled before setting other parameters.	
Note	Burst or sweep mode will be disabled if AM modulation is enabled. As only one modulation is allowed at any one time, other modulation modes will be disabled when AM modulation is enabled.	
Syntax	<b>SOURce[1 2]:AM:STATe {OFF ON}</b>	
Example	<b>SOUR1:AM:STAT ON</b> Enables AM modulation.	
Query Syntax	<b>SOURce[1 2]:AM:STATe?</b>	
Return Parameter	0	Disabled (OFF)
	1	Enabled (ON)
Example	<b>SOUR1:AM:STAT?</b> <b>1</b> AM modulation mode is currently enabled.	

<b>SOURce[1 2]:AM:INTernal:FUNCTion</b>		Source Specific Command
Description	Sets the shape of the modulating waveform from sine, square, triangle, upramp and dn ramp. The default shape is sine.	
Note	Square and triangle waveforms have a 50% duty cycle. Upramp and dn ramp have a symmetry of 100% and 0%, respectively.	
Syntax	<b>SOURce[1 2]:AM:INTernal:FUNCTion {SINusoid SQUare TRIangle UPRamp DNRamp}</b>	
Example	<b>SOUR1:AM:INT:FUNC SIN</b> Sets the AM modulating wave shape to sine.	

Query Syntax	<b>SOURce[1 2]:AM:INTernal:FUNction?</b>			
Return Parameter	SIN	Sine	UPRAMP	Upramp
	SQU	Square	DNRAMP	Dnramp
	TRI	Triangle		

**Example**                    **SOUR1:AM:INT:FUNC?**  
**SIN**  
The shape for the modulating waveform is Sine.

**SOURce[1|2]:AM:INTernal:FREQuency** Source Specific Command

---

**Description**                Sets the frequency of the internal modulating waveform only. The default frequency is 100Hz.

**Syntax**                      **SOURce[1|2]:AM:INTernal:FREQuency**  
**{<frequency>|MINimum|MAXimum}**

**Parameter**                <frequency>                2 mHz~ 20 kHz

**Example**                    **SOUR1:AM:INT:FREQ +1.0000E+02**  
Sets the modulating frequency to 100Hz.

**Query Syntax**            **SOURce[1|2]:AM:INTernal:FREQuency?**  
**[MINimum|MAXimum]**

**Return Parameter**      <NR3>                      Returns the frequency in Hz.

**Example**                    **SOUR1:AM:INT:FREQ? MIN**  
**+1.0000E+02**  
Returns the minimum frequency allowed.

**SOURce[1|2]:AM:DEPTh** Source Specific Command

---

**Description**                Sets or queries the modulation depth for internal sources only. The default is 100%.

Note	<p>The function generator will not output more than <math>\pm 5V</math>, regardless of the modulation depth.</p> <p>The modulation depth of an external source is controlled using the <math>\pm 5V</math> MOD INPUT terminal on the rear panel, and not the <code>SOURce[1 2]:AM:DEPT</code> command.</p>	
Syntax	<p><b><code>SOURce[1 2]:AM:DEPTH {&lt;depth in percent&gt;  MINimum MAXimum}</code></b></p>	
Parameter	<depth in percent>	0~120%
Example	<p><b><code>SOUR1:AM:DEPT 50</code></b></p> <p>Sets the modulation depth to 50%.</p>	
Query Syntax	<p><b><code>SOURce[1 2]:AM:DEPTH? [MINimum MAXimum]</code></b></p>	
Return Parameter	<NR3>	Return the modulation depth as a percentage.
Example	<p><b><code>SOUR1:AM:DEPT?</code></b></p> <p><b><code>+1.0000E+02</code></b></p> <p>The modulation depth is 100%.</p>	

## Frequency Modulation (FM) Commands

### FM Overview

---

The following is an overview of the steps required to generate an FM waveform.

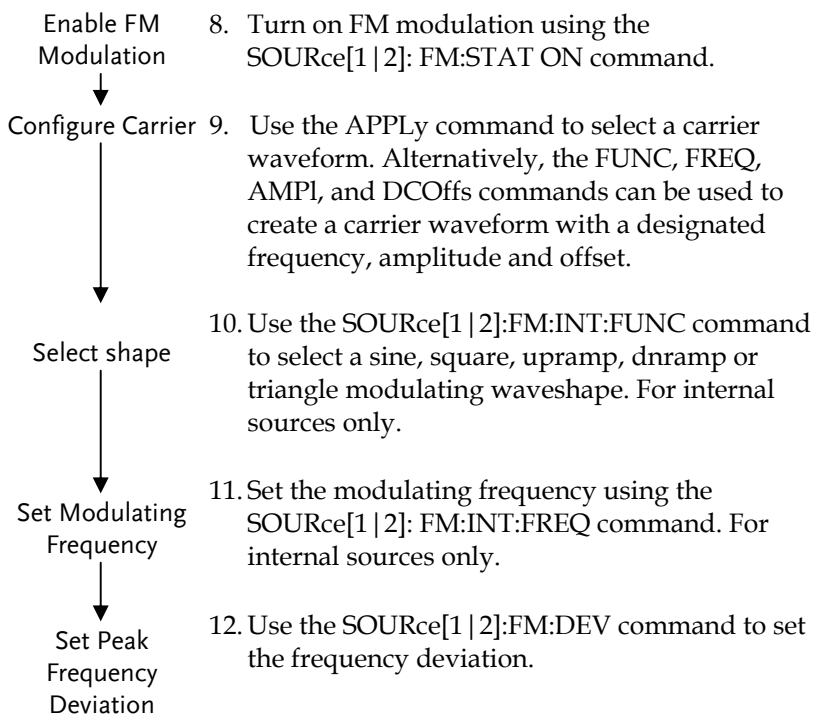

**SOURce[1|2]:FM:STATe** Source Specific Command

Description	Sets or disables FM modulation. By default FM modulation is disabled. FM modulation must be enabled before setting other parameters.	
Note	Burst or sweep mode will be disabled if FM modulation is enabled. As only one modulation is allowed at any one time, other modulation modes will be disabled when FM modulation is enabled.	
Syntax	<b>SOUR[1 2]:FM:STATe {OFF ON}</b>	
Example	<b>SOUR1:FM:STAT ON</b> Enables FM modulation.	
Query Syntax	<b>SOURce[1 2]:FM:STATe?</b>	
Return Parameter	0	Disabled (OFF)
	1	Enabled (ON)
Example	<b>SOUR1:FM:STAT?</b> <b>1</b> FM modulation mode is currently enabled.	

**SOURce[1|2]:FM:INTernal:FUNCTion** Source Specific Command

Description	Sets the shape of the modulating waveform from sine, square, triangle, upramp and dn ramp. The default shape is sine.	
Note	Square and triangle waveforms have a 50% duty cycle. Upramp and dn ramp have a symmetry of 100% and 0%, respectively.	
Syntax	<b>SOURce[1 2]:FM:INTernal:FUNCTion {SINusoid SQUare TRIangle UPRamp DNRamp}</b>	
Example	<b>SOUR1:FM:INT:FUNC SIN</b> Sets the FM modulating wave shape to sine.	

Query Syntax	<b>SOURce[1 2]:FM:INTernal:FUNCTION?</b>			
Return Parameter	SIN	Sine	UPRAMP	Upramp
	SQU	Square	DNRAMP	Dnramp
	TRI	Triangle		

**Example**                    **SOUR1:FM:INT:FUNC?**  
**SIN**  
The shape for the modulating waveform is Sine.

**SOURce[1|2]:FM:INTernal:FREQuency** Source Specific Command

---

**Description**                Sets the frequency of the internal modulating waveform only. The default frequency is 10Hz.

**Syntax**                      **SOURce[1|2]:FM:INTernal:FREQuency**  
**{<frequency>|MINimum|MAXimum}**

**Parameter**                 <frequency>                2 mHz~ 20 kHz

**Example**                    **SOUR1:FM:INT:FREQ 100**  
Sets the modulating frequency to 100Hz.

**Query Syntax**            **SOURce[1|2]:FM:INTernal:FREQuency?**  
**[MINimum|MAXimum]**

**Return Parameter**       <NR3>                        Returns the frequency in Hz.

**Example**                    **SOUR1:FM:INT:FREQ? MAX**  
**+2.0000E+04**  
Returns the maximum frequency allowed.

**SOURce[1|2]:FM:DEVIation** Source Specific Command

---



Description	<p>Sets or queries the peak frequency deviation of the modulating waveform from the carrier waveform. The default peak deviation is 100Hz.</p> <p>The frequency deviation of external sources is controlled using the <math>\pm 5V</math> MOD INPUT terminal on the rear panel. A positive signal (<math>&gt;0 \sim +5V</math>) will increase the deviation (up to the set frequency deviation), whilst a negative voltage will reduce the deviation.</p>	
Note	<p>The relationship of peak deviation to modulating frequency and carrier frequency is shown below.</p> <p>Peak deviation = modulating frequency - carrier frequency.</p> <p>The carrier frequency must be greater than or equal to the peak deviation frequency. The sum of the deviation and carrier frequency must not exceed the maximum frequency for a specific carrier shape. If an out of range deviation is set for any of the above conditions, the deviation will be automatically adjusted to the maximum value allowed and an "out of range" error will be generated.</p> <p>For square wave carrier waveforms, the deviation may cause the duty cycle frequency boundary to be exceeded. In these conditions the duty cycle will be adjusted to the maximum allowed and a "settings conflict" error will be generated.</p>	
Syntax	<p><b>SOURce[1 2]:FM:DEVIation {&lt;peak deviation in Hz&gt; MINimum MAXimum}</b></p>	
Parameter	<p>&lt;peak deviation in Hz&gt;</p>	<p>DC~25MHz DC~15MHz(square) DC~1MHz (Ramp)</p>
Example	<p><b>SOUR1:FM:DEV MAX</b></p> <p>Sets the frequency deviation to the maximum value allowed.</p>	

---

Query Syntax	<b>SOURce[1 2]:FM:DEVIation? [MINimum MAXimum]</b>
Return Parameter	<NR3> Returns the frequency deviation in Hz.
Example	<b>SOURce[1 2]:FM:DEVIation? MAX</b> <b>+1.0000E+01</b> Returns the maximum frequency deviation allowed.

## Frequency-Shift Keying (FSK) Commands

### FSK Overview

The following is an overview of the steps required to generate an FSK modulated waveform.

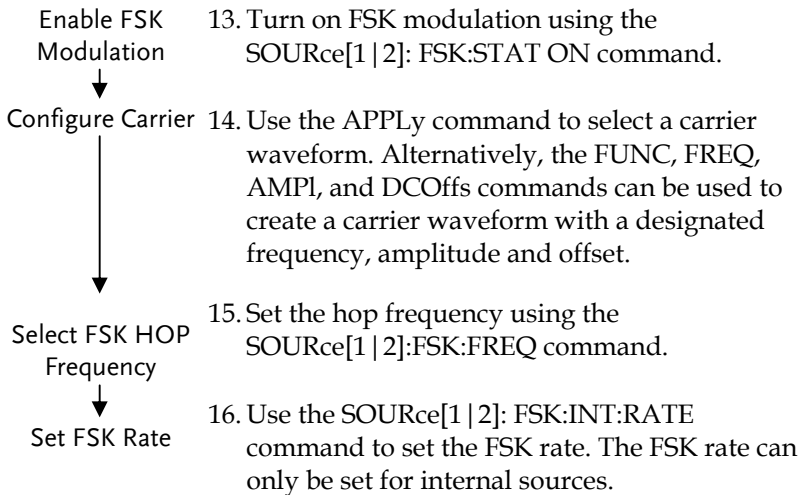

<code>SOURce[1 2]:FSKey:STATe</code>	Source Specific Command
Description	Turns FSK Modulation on or off. By default FSK modulation is off.
Note	Burst or sweep mode will be disabled if FSK modulation is enabled. As only one modulation is allowed at any one time, other modulation modes will be disabled when FSK modulation is enabled.
Syntax	<code>SOURce[1 2]:FSKey:STATe {OFF ON}</code>

Example	<b>SOUR1:FSK:STAT ON</b> Enables FSK modulation
Query Syntax	<b>SOURce[1 2]:FSKey:STATe?</b>
Return Parameter	0 Disabled (OFF) 1 Enabled (ON)
Example	<b>SOUR1:FSK:STAT?</b> <b>1</b> FSK modulation is currently enabled.

**SOURce[1|2]:FSKey:FREQUENCY** Source Specific Command

---

Description	Sets the FSK hop frequency. The default hop frequency is set to 100Hz.	
Note	For FSK, the modulating waveform is a square wave with a duty cycle of 50%.	
Syntax	<b>SOURce[1 2]:FSKey:FREQUENCY {&lt;frequency&gt; MINimum MAXimum}</b>	
Parameter	<frequency>	1 μHz~25MHz(sine) 1 μHz~15MHz(Square, Pulse) 1 μHz~1MHz(Ramp)
Example	<b>SOUR1:FSK:FREQ +1.0000E+02</b> Sets the FSK hop frequency to to 100Hz.	
Query Syntax	<b>SOURce[1 2]:FSKey:FREQUENCY? [MINimum MAXimum]</b>	
Return Parameter	<NR3>	Returns the frequency in Hz.
Example	<b>SOUR1:FSK:FREQ? MAX</b> <b>+2.5000E+06</b> Returns the maximum hop frequency allowed.	

<b>SOURce[1 2]:FSKey:INTernal:RATE</b>		Source Specific Command
Description	Sets or queries the FSK rate for internal sources only.	
Note	External sources will ignore this command.	
Syntax	<b>SOURce[1 2]:FSKey:INTernal:RATE {&lt;rate in Hz&gt;  MINimum MAXimum}</b>	
Parameter	<rate in Hz>	2 mHz~100 kHz
Example	<b>SOUR1:FSK:INT:RATE MAX</b> Sets the rate to the maximum (100kHz).	
Query Syntax	<b>SOURce[1 2]:FSKey:INTernal:RATE?  MINimum MAXimum</b>	
Return Parameter	<NR3>	Returns the FSK rate in Hz.
Example	<b>SOUR1:FSK:INT:RATE? MAX</b> <b>+1.0000E+05</b> Returns the maximum FSK rate allowed.	

## Phase Modulation (PM) Commands

### PM Overview

The following is an overview of the steps required to generate a PM modulated waveform.

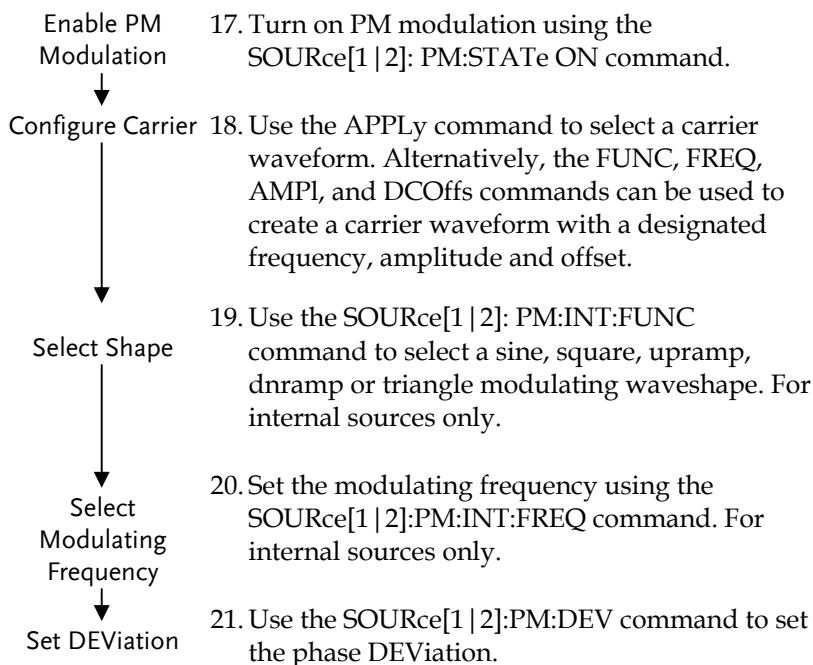

<b>SOURce[1 2]:PM:STATe</b>		Source Specific Command
Description	Turns PM Modulation on or off. By default PM modulation is off.	
Note	Burst or sweep mode will be disabled if PM modulation is enabled. As only one modulation is allowed at any one time, other modulation modes will be disabled when PM modulation is enabled.	
Syntax	<b>SOURce[1 2]:PM:STATe {OFF ON}</b>	
Example	<b>SOUR1:PM:STAT ON</b> Enables PM modulation	
Query Syntax	<b>SOURce[1 2]:PM:STATe?</b>	
Return Parameter	0	Disabled (OFF)
	1	Enabled (ON)
Example	<b>SOUR1:PM:STAT?</b> <b>1</b> PM modulation is currently enabled.	

<b>SOURce[1 2]:PM:INTernal:FUNction</b>		Source Specific Command
Description	Sets the shape of the modulating waveform from sine, square, triangle, upramp and dn ramp. The default shape is sine.	
Note	Square and triangle waveforms have a 50% duty cycle. Upramp and dn ramp have a symmetry to 100% and 0%, respectively. .	
Syntax	<b>SOURce[1 2]:PM:INTernal:FUNction {SINusoid SQUare TRiangle UPRamp DNRamp}</b>	
Example	<b>SOUR1:PM:INT:FUN SIN</b> Sets the PM modulating wave shape to sine. .	
Query Syntax	<b>SOURce[1 2]:PM:INTernal:FUNction?</b>	

Return Parameter	SIN	Sine	UPRAMP	Upramp
	SQU	Square	DNRAMP	Dnramp
	TRI	Triangle		

**Example**      **SOUR1:PM:INT:FUNC?**  
**SIN**  
 The shape for the modulating waveform is Sine.

**SOURce[1|2]:PM:INTernal:FREQuency**      Source Specific Command

**Description**      Sets the modulating waveform frequency for internal sources. The default frequency is set to 100Hz.

**Syntax**      **SOURce[1|2]:PM:INTernal:FREQuency**  
**{<frequency>|MINimum|MAXimum}**

**Parameter**      <frequency>      2 mHz~ 20 kHz

**Example**      **SOUR1:PM:INT:FREQ MAX**  
 Sets the frequency to the maximum value.

**Query Syntax**      **SOURce[1|2]:PM:INTernal:FREQuency?**

**Return Parameter**      <NR3>      Returns the frequency in Hz.

**Example**      **SOUR1:PM:INT:FREQ? MAX**  
**+2.0000E+04**  
 Returns the modulating frequency. (20kHz)

**SOURce[1|2]:PM:DEVIation**      Source Specific Command

**Description**      Sets or queries the phase deviation of the modulating waveform from the carrier waveform. The default phase deviation is 180°.



Note	For external sources, the phase deviation is controlled by the $\pm 5V$ MOD Input terminal on the rear panel. If the phase deviation is set to 180 degrees, then +5V represents a deviation of 180 degrees. A lower input voltage will decrease the set phase deviation.	
Syntax	<b>SOURce[1 2]:PM:DEVIation {&lt; phase&gt; minimum  maximum}</b>	
Parameter	<percent>	0°~360°
Example	<b>SOUR1:PM:DEVIation +3.0000E+01</b> Sets the deviation to 30°.	
Query Syntax	<b>SOURce[1 2]:PM:DEVIation?</b>	
Return Parameter	<NR3>	Returns the deviation .
Example	<b>SOUR1:PM:DEVIation?</b> <b>+3.0000E+01</b> The current deviation is 30°.	

## SUM Modulation (SUM) Commands

### SUM Overview

The following is an overview of the steps required to generate a SUM modulated waveform.

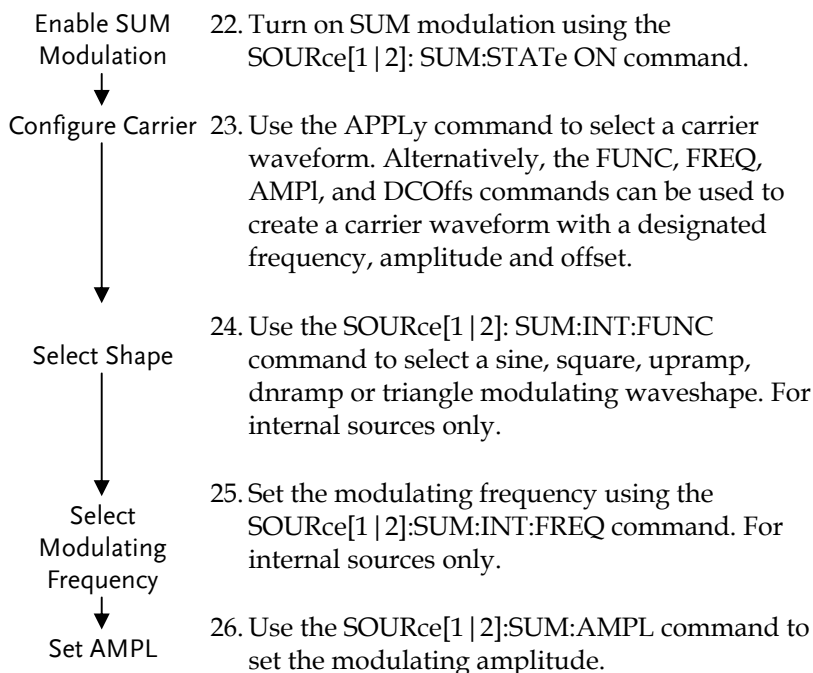

<b>SOURce[1 2]:SUM:STATe</b>		Source Specific Command
Description	Turns SUM Modulation on or off. By default SUM modulation is off.	
Note	Burst or sweep mode will be disabled if SUM modulation is enabled. As only one modulation is allowed at any one time, other modulation modes will be disabled when SUM modulation is enabled.	
Syntax	<b>SOURce[1 2]:SUM:STATe {OFF ON}</b>	
Example	<b>SOUR1:SUM:STAT ON</b> Enables SUM modulation	
Query Syntax	<b>SOURce[1 2]:SUM:STATe?</b>	
Return Parameter	0	Disabled (OFF)
	1	Enabled (ON)
Example	<b>SOUR1:SUM:STAT?</b> <b>ON</b> SUM modulation is currently enabled.	

<b>SOURce[1 2]:SUM:INTernal:FUNction</b>		Source Specific Command
Description	Sets the shape of the modulating waveform from sine, square, triangle, upramp and dn ramp. The default shape is sine.	
Note	Square and triangle waveforms have a 50% duty cycle. Upramp and dn ramp have a symmetry to 100% and 0%, respectively. .	
Syntax	<b>SOURce[1 2]:SUM:INTernal:FUNction {SINusoid SQUare TRIangle UPRamp DNRamp}</b>	
Example	<b>SOUR1:SUM:INT:FUN SIN</b> Sets the SUM modulating wave shape to sine.	

Query Syntax	<b>SOURce[1 2]:SUM:INTernal:FUNction?</b>			
Return Parameter	SIN	Sine	UPRAMP	Upramp
	SQU	Square	DNRAMP	Dnramp
	TRI	Triangle		

**Example**                    **SOUR1:SUM:INT:FUNC?**  
**SIN**  
 The shape for the modulating waveform is Sine.

**SOURce[1|2]:SUM:INTernal:FREQuency**                    Source Specific Command

---

**Description**                Sets the modulating waveform frequency for internal sources. The default frequency is set to 100Hz.

**Syntax**                        **SOURce[1|2]:SUM:INTernal:FREQuency**  
**{<frequency>|MINimum|MAXimum}**

**Parameter**                 <frequency>                    2 mHz~ 20 kHz

**Example**                    **SOUR1:SUM:INT:FREQ MAX**  
 Sets the frequency to the maximum value.

**Query Syntax**              **SOURce[1|2]:SUM:INTernal:FREQuency?**

**Return Parameter**        <NR3>                            Returns the frequency in Hz.

**Example**                    **SOUR1:SUM:INT:FREQ? MAX**  
**+2.0000E+04**  
 Returns the modulating frequency (20kHz).

**SOURce[1|2]:SUM:AMPL**                                    Source Specific Command

---

**Description**                Sets or queries the amplitude of the modulating waveform from the carrier waveform. The default phase amplitude is 50%.

Note	If an external SUM source is selected, the amplitude of the modulated waveform is controlled using the $\pm 5V$ MOD INPUT terminal on the rear panel. A positive signal ( $>0 \sim +5V$ ) will increase the AMPLitude (up to the set amplitude), whilst a negative voltage will reduce the amplitude.	
Syntax	<b>SOURce[1 2]:SUM:AMPL{&lt; percent&gt; minimum maximum}</b>	
Parameter	<percent>	0%~100%
Example	<b>SOUR1:SUM:AMPLitude +3.0000E+01</b> Sets the amplitude to 30%.	
Query Syntax	<b>SOURce[1 2]:SUM:AMPLitude?</b>	
Return Parameter	<NR3>	Returns the amplitude .
Example	<b>SOUR1:SUM:AMPLitude?</b> <b>+3.0000E+01</b> The current amplitude is 30%.	

## Frequency Sweep Commands

### Sweep Overview

Below shows the order in which commands must be executed to perform a sweep.

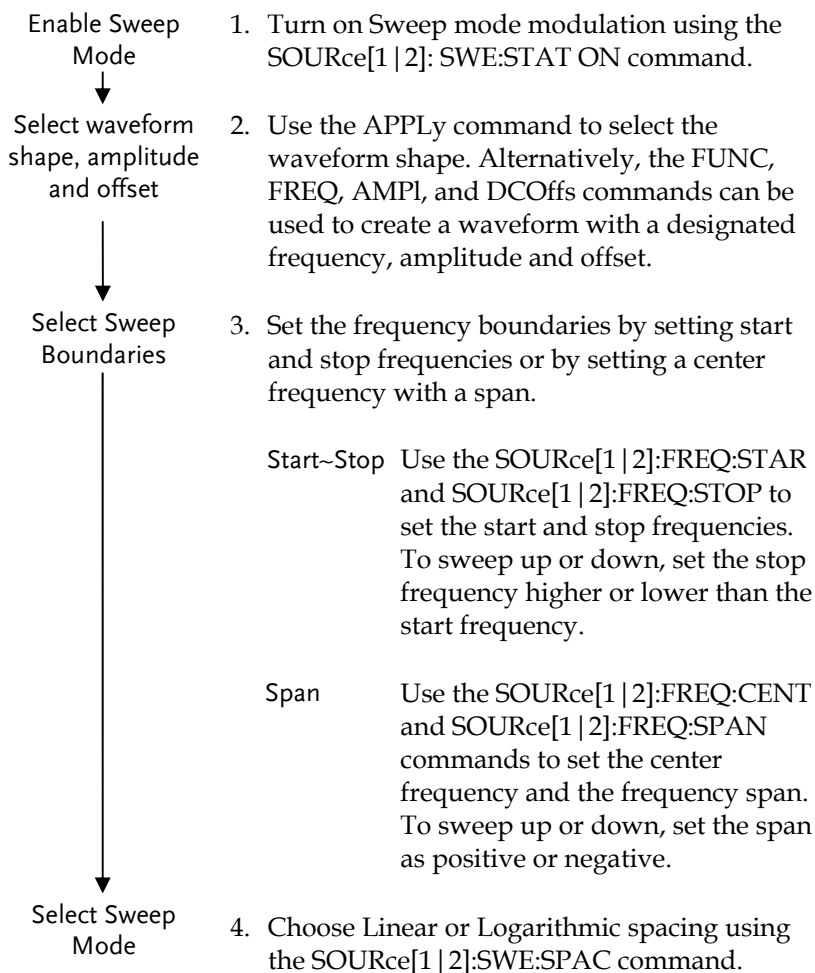

- |   |  |
|---|--|
| Select Sweep Time<br>↓<br>Select the sweep trigger source<br>↓<br>Select the marker frequency | 5. Choose the sweep time using the <code>SOURce[1   2]:SWE:TIME</code> command.<br><br>6. Select an internal or external sweep trigger source using the <code>SOURce[1   2]:SOUR</code> command.<br><br>7. To output a marker frequency from the trigger out, use The <code>SOURce[1   2]:MARK:FREQ</code> command. To enable marker frequency output, use the <code>SOURce[1   2]:MARK ON</code> command. |
|---|--|

The marker frequency can be set to a value within the sweep span.

<code>SOURce[1   2]:SWEep:STATe</code>		Source Specific Command
Description	Sets or disables Sweep mode. By default Sweep is disabled. Sweep modulation must be enabled before setting other parameters.	
Note	Any modulation modes or Burst mode will be disabled if sweep mode is enabled.	
Syntax	<b><code>SOURce[1   2]:SWEep:STATe {OFF ON}</code></b>	
Example	<b><code>SOUR1:SWE:STAT ON</code></b> Enables sweep mode.	
Query Syntax	<b><code>SOURce[1   2]:SWEep:STATe?</code></b>	
Return Parameter	0	Disabled (OFF)
	1	Enabled (ON)
Example	<b><code>SOUR1:SWE:STAT?</code></b> 1 Sweep mode is currently enabled.	

<b>SOURce[1 2]:FREQuency:STARt</b>		Source Specific Command
Description	Sets the start frequency of the sweep. 100Hz is the default start frequency.	
Note	To sweep up or down, set the stop frequency higher or lower than the start frequency.	
Syntax	<b>SOURce[1 2]:FREQuency:STARt {&lt;frequency&gt; MINimum MAXimum}</b>	
Parameter	<frequency>	1μHz~ 25MHz 1μHz~ 15MHz (Square) 1μHz~ 1MHz (Ramp)
Example	<b>SOUR1:FREQ:STAR +2.0000E+03</b> Sets the start frequency to 2kHz.	
Query Syntax	<b>SOURce[1 2]:FREQuency:STARt? [MINimum MAXimum]</b>	
Return Parameter	<NR3>	Returns the start frequency in Hz.
Example	<b>SOUR1:FREQ:STAR? MAX +8.0000E+0</b> Returns the maximum start frequency allowed.	

<b>SOURce[1 2]:FREQuency:STOP</b>		Source Specific Command
Description	Sets the stop frequency of the sweep. 1 kHz is the default start frequency.	
Note	To sweep up or down, set the stop frequency higher or lower than the start frequency.	
Syntax	<b>SOURce[1 2]:FREQuency:STOP {&lt;frequency&gt; MINimum MAXimum}</b>	



Parameter	<frequency>	1μHz~ 25MHz 1μHz~ 15MHz(Square) 1μHz~ 1MHz (Ramp)
Example	<b>SOUR1:FREQ:STOP +2.0000E+03</b> Sets the stop frequency to 2kHz.	
Query Syntax	<b>SOURce[1 2]:FREQuency:STOP? [MINimum] MAXimum]</b>	
Return Parameter	<NR3>	Returns the stop frequency in Hz.
Example	<b>SOUR1:FREQ:STOP? MAX +8.0000E+00</b> Returns the maximum stop frequency allowed.	

**SOURce[1|2]:FREQuency:CENTer** Source Specific Command

---

Description	Sets and queries the center frequency of the sweep. 550 Hz is the default center frequency.	
Note	The maximum center frequency depends on the sweep span and maximum frequency: max center freq = max freq - span/2	
Syntax	<b>SOURce[1 2]:FREQuency:CENTer {&lt;frequency&gt; MINimum MAXimum}</b>	
Parameter	<frequency>	450Hz~ 25MHz 450Hz~ 15MHz(Square) 450Hz~ 1MHz (Ramp)
Example	<b>SOUR1:FREQ:CENT +2.0000E+03</b> Sets the center frequency to 2kHz.	
Query Syntax	<b>SOURce[1 2]:FREQuency:CENTer? [MINimum] MAXimum]</b>	
Return Parameter	<NR3>	Returns the stop frequency in Hz.

**Example**                    **SOUR1:FREQ:CENT? MAX**  
**+8.0000E+00**

Returns the maximum center frequency allowed, depending on the span.

**SOURce[1|2]:FREQuency:SPAN**                    Source Specific Command

**Description**                Sets and queries the frequency span of the sweep. 900 Hz is the default frequency span. The span frequency is equal to the stop-start frequencies.

**Note**                        To sweep up or down, set the span as positive or negative.

The maximum span frequency has a relationship to the center frequency and maximum frequency:  
 $\text{max freq span} = 2(\text{max freq} - \text{center freq})$

**Syntax**                    **SOURce[1|2]:FREQuency:SPAN**  
**{<frequency>|MINimum|MAXimum}**

<b>Parameter</b>	<b>&lt;frequency&gt;</b>	+/-1μHz~ +/- 25MHz +/-1μHz~ +/-15MHz(Squa) +/-1μHz~ +/-1MHz (Ramp)
------------------	--------------------------	---

**Example**                    **SOUR1:FREQ:SPAN +2.0000E+03**

Sets the frequency span to 2kHz.

**Query Syntax**            **SOURce[1|2]:FREQuency:SPAN? [MINimum|MAXimum]**

<b>Return Parameter</b>	<b>&lt;NR3&gt;</b>	Returns the frequency span in Hz.
-------------------------	--------------------	-----------------------------------

**Example**                    **SOUR1:FREQ:SPAN?**  
**+2.0000E+03**

Returns the frequency span for the current sweep.

<b>SOURce[1 2]:SWEep:SPACing</b>		Source Specific Command
Description	Sets linear or logarithmic sweep spacing. The default spacing is linear.	
Syntax	<b>SOURce[1 2]:SWEep:SPACing {LINear LOGarithmic}</b>	
Example	<b>SOUR1:SWE:SPAC LIN</b> Sets the spacing to linear.	
Query Syntax	<b>SOURce[1 2]:SWEep:SPACing?</b>	
Return Parameter	LIN	Linear spacing
	LOG	Logarithmic spacing
Example	<b>SOUR1:SWE:SPAC?</b> <b>LIN</b> The spacing is currently set as linear.	

<b>SOURce[1 2]:SWEep:TIME</b>		Source Specific Command
Description	Sets or queries the sweep time. The default sweep time is 1 second.	
Note	The function generator automatically determines the number of frequency points that are used for the sweep based on the sweep time.	
Syntax	<b>SOURce[1 2]:SWEep:TIME {&lt;seconds&gt; MINimum MAXimum}</b>	
Parameter	<seconds>	1 ms ~ 500 s
Example	<b>SOUR1:SWE:TIME +1.0000E+00</b> Sets the sweep time to 1 second.	
Query Syntax	<b>SOURce[1 2]:SWEep:TIME? {&lt;seconds&gt; MINimum MAXimum}</b>	
Return Parameter	<NR3>	Returns sweep time in seconds.

Example            **SOUR1:SWE:TIME?**  
                       **+2.0000E+01**  
                       Returns the sweep time (20 seconds).

**SOURce[1|2]:SWEep:SOURce** Source Specific Command

---

Description        Sets or queries the trigger source as immediate (internal) or manual. Immediate (internal) is the default trigger source. IMMEDIATE will constantly output a swept waveform. Manual will output a swept waveform after the trigger softkey is pressed.

Note                If the APPLy command was used to create the waveform shape, the source is automatically set to IMMEDIATE.  
                       The \*OPC/\*OPC? command/query can be used to signal the end of the sweep.

Syntax             **SOURce[1|2]: SWEep:SOURce {IMMEDIATE|MANual}**

Example            **SOUR1: SWE:SOUR IMM**  
                       Sets the sweep source to immediate.

Query Syntax      **SOURce[1|2]: SWEep:SOURce?**

Return Parameter	IMM	Immediate
	MANual	Manual

Example            **SOUR1:SWE:SOUR?**  
                       **IMM**  
                       The sweep source is set to immediate.

<b>SOURce[1 2]:MARKer:FREQuency</b>		Source Specific Command
Description	Sets or queries the marker frequency. The default marker frequency is 550 Hz. The marker frequency is used to output a trigger out signal from the trigger terminal on the front panel.	
Note	The marker frequency must be between the start and stop frequencies. If the marker frequency is set to a value that is out of the range, the marker frequency will be set to the center frequency and a “settings conflict” error will be generated.	
Syntax	<b>SOURce[1 2]:MARKer:FREQuency {&lt;frequency&gt; MINimum MAXimum}</b>	
Parameter	<b>&lt;frequency&gt;</b>	1 μHz ~ 25 MHz 1 μHz ~ 1 MHz (Ramp)
Example	<b>SOUR1:MARK:FREQ +1.0000E+03</b> Sets the marker frequency to 1 kHz.	
Query Syntax	<b>SOURce[1 2]:MARKer:FREQuency? [MINimum MAXimum]</b>	
Return Parameter	<b>&lt;NR3&gt;</b>	Returns the marker frequency in Hz.
Example	<b>SOUR1:MARK:FREQ? MAX +1.0000E+03</b> Returns the marker frequency (1 kHz).	
<b>SOURce[1 2]:MARKer</b>		Source Specific Command

Description	Turns the marker frequency on or off. The default is off.	
Note	<p>MARKer ON The SYNC signal goes logically high/low at the start of each sweep and goes low/high at the marker frequency.</p> <hr/> <p>MARKer OFF The SYNC signal turn off</p>	
Syntax	<b>SOURce[1 2]:MARKer {OFF ON}</b>	
Example	<b>SOUR1:MARK ON</b> Enables the marker frequency.	
Query Syntax	<b>SOURce[1 2]:MARKer?</b>	
Return Parameter	0	Disabled
	1	Enabled
Example	<p><b>SOUR1:MARK?</b> <b>1</b> The marker frequency is enabled.</p>	

## Burst Mode Commands

### Burst Mode Overview

---

Burst mode can be configured to use an internal trigger (N Cycle mode). Using N Cycle mode, each time the function generator receives a trigger, the function generator will output a specified number of waveform cycles (burst). After the burst, the function generator will wait for the next trigger before outputting another burst. N Cycle is the default Burst mode.

\*assuming the Trigger polarity is not inverted.

The burst mode depends on the source of the trigger (internal, manual) and the source of the burst.

Burst Mode & Source	Function		
	N Cycle*	Cycle	Phase
Triggered – IMMEDIATE, BUS	Available	Available	Available
Triggered - MANUAL	Available	Unused	Available
Gated pulse - IMMEDIATE	Unused	Unused	Available

\*burst count

The following is an overview of the steps required to generate a burst waveform.

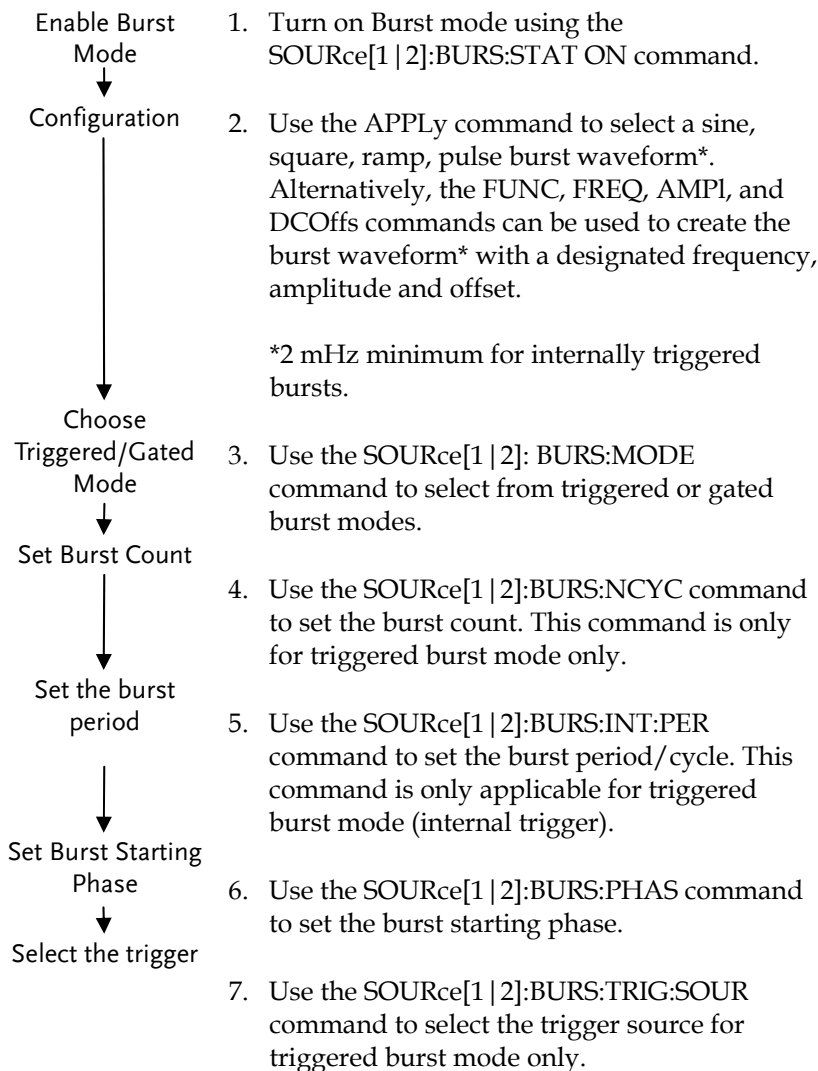



**SOURce[1|2]:BURSt:STATe** Source Specific Command

**Description** Turns burst mode on or off. By default burst mode is turned off.

**Note** When burst mode is turned on, sweep and any modulation modes are disabled.

**Syntax** **SOURce[1|2]:BURSt:STATe {OFF|ON}**

**Example** **SOUR1:BURSt:STAT ON**  
Turns burst mode on.

**Query Syntax** **SOURce[1|2]:BURSt:STATe?**

**Return Parameter** 0 Disabled  
1 Enabled

**Example** **SOUR1:BURSt:STAT?**  
**0**  
Burst mode is off.

**SOURce[1|2]:BURSt:MODE** Source Specific Command

**Description** Sets or queries the burst mode is triggered. The default burst mode is triggered.

**Syntax** **SOURce[1|2]:BURSt:MODE TRIGgered**

**Example** **SOUR1:BURSt:MODE TRIG**  
Sets the burst mode to triggered.

**Query Syntax** **SOURce[1|2]:BURSt:MODE?**

**Return Parameter** TRIG Triggered mode

**Example** **SOUR1:BURSt:MODE?**  
**TRIG**

The current burst mode is triggered.

<b>SOURce[1 2]:BURSt:NCYCles</b>		Source Specific Command
Description	Sets or queries the number of cycles (burst count) in triggered burst mode. The default number of cycles is 1. The burst count is ignored in gated mode.	
Note	<p>If the trigger source is set to immediate, the product of the burst period and waveform frequency must be greater than the burst count:                      Burst Period X Waveform frequency &gt; burst count</p> <p>If the burst count is too large, the burst period will automatically be increased and a "Settings conflict" error will be generated.</p> <p>Only sine and square waves are allowed infinite burst above 15 MHz.</p>	
Syntax	<b>SOURce[1 2]:BURSt:NCYCles{&lt; # cycles&gt;  INFinity MINimum  MAXimum}</b>	
Parameter	<# cycles>	1~65535 cycles.
	INFinity	Sets the number to continuous.
	MINimum	Sets the number to minimum allowed.
	MAXimum	Sets the number to maximum allowed.
Example	<p><b>SOUR1:BURSt:NCYCle INF</b></p> <p>Sets the number of burst cycles to continuous (infinite).</p>	
Query Syntax	<b>SOURce[1 2]:BURSt:NCYCles? [MINimum MAXimum]</b>	
Return Parameter	<NR3>	Returns the number of cycles.
	INF	INF is returned if the number of cycles is continuous.
Example	<p><b>SOUR1:BURSt:NCYC? +1.0000E+02</b></p> <p>The burst cycles are set to 100.</p>	

<b>SOURce[1 2]:BURSt:INTernal:PERiod</b>		Source Specific Command
Description	<p>Sets or queries the burst period. Burst period settings are only applicable when the trigger is set to immediate. The default burst period is 10 ms.</p> <p>During manual triggering, external triggering or Gate burst mode, the burst period settings are ignored.</p>	
Note	<p>The burst period must be long enough to output the designated number of cycles for a selected frequency.</p> <p>Burst period &gt; burst count / (waveform frequency + 200 ns)</p> <p>If the period is too short, it is automatically increased so that a burst can be continuously output. A "data out of range" error will also be generated.</p>	
Syntax	<b>SOURce[1 2]:BURSt:INTernal:PERiod</b>	
	<b>{&lt;seconds&gt; MINimum MAXimum}</b>	
Parameter	<seconds >	1 ms ~ 500 seconds
Example	<b>SOUR1:BURSt:INT:PER +1.0000E+01</b>	
	Sets the period to 10 seconds.	
Query Syntax	<b>SOURce[1 2]:BURSt:INTernal:PERiod?</b>	
	<b>[MINimum MAXimum]</b>	
Return Parameter	<NR3>	Returns the burst period in seconds.
Example	<b>SOUR1:BURSt:INT:PER?</b>	
	<b>+1.0000E+01</b>	
	The burst period is 10 seconds.	
<b>SOURce[1 2]:BURSt:PHASe</b>		Source Specific Command

**Description**                Sets or queries the starting phase for the burst. The default phase is 0 degrees. At 0 degrees, sine square and ramp waveforms are at 0 volts.

In gated burst mode, waveforms are continuously output (burst) when the Trig signal is true. The voltage level at the starting phase is used to determine the voltage level of the signal in-between bursts.

**Note**                                The phase command is not used with pulse waveforms.

**Syntax**                            **SOURce[1|2]:BURSt:PHASe**  
**{<angle>|MINimum|MAXimum}**

**Parameter**                    <angle>                    -360 ~ 360 degrees

**Example**                        **SOUR1:BURSt:PHAS MAX**

Sets the phase to 360 degrees.

**Query Syntax**                **SOURce[1|2]:BURSt:PHASe? [MINimum|MAXimum]**

**Return Parameter**        <NR3>                    Returns the phase angle in degrees.

**Example**                        **SOUR1:BURSt:PHAS?**  
**+1.2000E+02**

The burst phase is 120 degrees.

**SOURce[1|2]:BURSt:TRIGger:SOURce**                    Source Specific Command

**Description**                Sets or queries the trigger source for triggered burst mode. In triggered burst mode, a waveform burst is output each time a trigger signal is received and the number of cycles is determined by the burst count.

There are three trigger sources for triggered burst mode:

**Immediate**                    A burst is output at a set frequency determined by the burst period.

	Manual	Manual triggering will output a burst waveform after the trigger softkey is pressed.
Note	<p>If the APPLy command was used, the source is automatically set to IMMEDIATE.</p> <p>The *OPC/*OPC? command/query can be used to signal the end of the burst.</p>	
Syntax	<b>SOURce[1 2]:BURSt:TRIGger:SOURce {IMMEDIATE MANual}</b>	
Example	<p><b>SOUR1:BURS:TRIG:SOUR IMM</b></p> <p>Sets the burst trigger source to immediate.</p>	
Query Syntax	<b>SOURce[1 2]:BURSt:TRIGger:SOURce?</b>	
Return Parameter	IMM	Immediate
	MANual	Manual
Example	<p><b>SOUR1:BURS:TRIG:SOUR?</b></p> <p><b>IMM</b></p> <p>The burst trigger source is set to immediate.</p>	
<b>SOURce[1 2]:BURSt:TRIGger:DELay</b>		Source Specific Command
Description	The DELay command is used to insert a delay (in seconds) before a burst is output. The delay starts after a trigger is received. The default delay is 0 seconds.	
Syntax	<b>SOURce[1 2]: BURSt:TRIGger:DELay {&lt;seconds&gt; MINimum MAXimum}</b>	
Parameter	<seconds>	0~655350 nS
Example	<p><b>SOUR1:BURS:TRIG:DEL +1.0000E+01</b></p> <p>Sets the trigger delay to 10 seconds.</p>	
Query Syntax	<b>SOURce[1 2]:BURSt:TRIGger:DELay? [MINimum MAXimum]</b>	

Return Parameter	<NRf>	Delay in seconds
Example	<b>SOUR1:BURS:TRIG:DEL ?</b> <b>+1.0000E+01</b> The trigger delay is 10 seconds.	

**SOURce[1|2]:BURSt:TRIGger:SLOPe** Source Specific Command

---

**Description** Sets or queries the trigger edge for externally triggered bursts from the Trigger INPUT terminal on the rear panel. By default the trigger is rising edge (Positive).

**Syntax** **SOURce[1|2]:BURSt:TRIGger:SLOPe {POSitive|NEGative}**

Parameter	POSitive	rising edge
	NEGative	falling edge

**Example** **SOUR1:BURS:TRIG:SLOP NEG**  
 Sets the trigger slope to negative.

**Query Syntax** **SOURce[1|2]:BURSt:TRIGger:SLOPe?**

Return Parameter	POS	rising edge
	NEG	falling edge

**Example** **SOUR1:BURS:TRIG:SLOP ?**  
**NEG**  
 The trigger slope is negative.

**SOURce[1|2]:BURSt:GATE:POLarity** Source Specific Command

---

**Description** In gated mode, the function generator will output a waveform continuously while the external trigger receives logically true signal from the Trigger INPUT terminal. Normally a signal is logically true when it is high. The logical level can be inverted so that a low signal is considered true.

Syntax	<b>SOURce[1 2]:BURSt:GATE:POLarity</b> <b>{NORMAl INVertes}</b>	
Parameter	NORMAl	Logically high
	INVertes	Logically low
Example	<b>SOUR1:BURS:GATE:POL INV</b> Sets the state to logically low (inverted).	
Query Syntax	<b>SOURce[1 2]:BURSt:GATE:POLarity?</b>	
Return Parameter	NORM	Normal(High) logical level
	INV	Inverted (low) logical level
Example	<b>SOUR1:BURS:GATE:POL?</b> <b>INV</b> The true state is inverted(logically low).	

Source Specific Command

**SOURce[1|2]:BURSt:OUTPut:TRIGger:SLOPe**

Description	Sets or queries the trigger edge of the trigger output signal. The signal is output from the trigger out terminal on the rear panel. The default trigger output slope is positive.	
	Immediate	50% duty cycle square wave is output at the start of each burst.
	External	Trigger output disabled.
	Gated mode	Trigger output disabled.
	Manual	A >1 ms pulse is output at the start of each burst.
Syntax	<b>SOURce[1 2]:BURSt:OUTPut:TRIGger:SLOPe</b> <b>{POSitive NEGative}</b>	
Parameter	POSitive	Rising edge.
	NEGative	Falling edge.
Example	<b>SOUR1:BURS:OUTP:TRIG:SLOP POS</b>	

Sets the trigger output signal slope to positive (rising edge).

Query Syntax **SOURce[1|2]:BURSt:OUTPut:TRIGger:SLOPe?**

Return Parameter	POS	Rising edge.
	NEG	Falling edge.

Example **SOUR1:BURS:OUTP:TRIG:SLOP?**  
**POS**

The trigger output signal slope to positive.

**SOURce[1|2]:BURSt:OUTPut[1|2]:TRIGger** Source Specific Command

Description Sets or queries the trigger output signal on or off. By default the signal is disabled. When enabled, a TTL compatible square wave is output.

Syntax **SOURce[1|2]:BURSt:OUTPut[1|2]:TRIGger {OFF|ON}**

Parameter	<b>OFF</b>	Turns the output off.
	<b>ON</b>	Turns the output on.

Example **SOURce[1|2]:BURSt:OUTP1:TRIG ON**  
Turns the output on.

Query Syntax **SOURce[1|2]:BURSt:OUTPut[1|2]:TRIGger?**

Return Parameter	<b>0</b>	Disabled
	<b>1</b>	Enabled

Query Example **SOURce[1|2]:BURSt:OUTP1:TRIG?**  
**1**  
The trigger output is enabled.



# Arbitrary Waveform Commands

## Arbitrary Waveform Overview

Use the steps below to output an arbitrary waveform over the remote interface.

- |  |  |
|--|--|
| Output Arbitrary Waveform<br>↓                       | 1. Use the <code>SOURce[1   2]:FUNCtion USER</code> command to output the arbitrary waveform currently selected in memory.   |
| Select Waveform Frequency, amplitude and offset<br>↓ | 2. Use the <code>APPLy</code> command to select frequency, amplitude and DC offset. Alternatively, the <code>FUNC</code> , <code>FREQ</code> , <code>AMPL</code> , and <code>DCOffs</code> commands can be used. |
| Load Waveform Data<br>↓                              | 3. Waveform data (1 to 4096 points per waveform) can be downloaded into volatile memory using the <code>DATA:DAC</code> command. Binary integer or decimal integer values in the range of $\pm 511$ can be used. |
| Set Waveform Rate<br>↓                               | 4. The waveform rate is the product of the number of points in the waveform and the waveform frequency.  |

$$\text{Rate} = \text{Hz} \times \# \text{ points}$$

Range:	Rate:	120MHz
	Frequency:	60MHz
	# points:	1~4096

<b>SOURce[1 2]:FUNction USER</b>		Source Specific Command
Description	Use the SOURce[1   2]:FUNction USER command to output the arbitrary waveform currently selected in memory. The waveform is output with the current frequency, amplitude and offset settings.	
Syntax	<b>SOURce[1 2]:FUNction USER</b>	
Example	<b>SOUR1:FUNC USER</b>  Selects and outputs the current waveform in memory.	

<b>SOURce[1 2]:DATA:DAC</b>		Source Specific Command
Description	The SOURce[1   2]:DATA:DAC command is used to download binary or decimal integer values into memory using the IEEE-488.2 binary block format or as an ordered list of values.	
Note	<p>The integer values (<math>\pm 511</math>) correspond to the maximum and minimum peak amplitudes of the waveform. For instance, for a waveform with an amplitude of 5Vpp (0 offset), the value 511 is the equivalent of 2.5 Volts. If the integer values do not span the full output range, the peak amplitude will be limited.</p>	

The IEEE-488.2 binary block format is comprised of three parts:

$\# \ 7 \ 2097152$ 	<ol style="list-style-type: none"> <li>1. Initialization character (#)</li> <li>2. Digit length (in ASCII) of the number of bytes</li> <li>3. Number of bytes</li> </ol>
------------------------	--

IEEE 488.2 uses two bytes to represent waveform

data (16 bit integer). Therefore the number of bytes is always twice the number of data points.

Syntax **SOURce[1|2]:DATA:DAC VOLATILE, <start>, {<binary block>|<value>, <value>, . . . }**

Parameter	<start>	Start address of the arbitrary waveform
	<binary block>	
	<value>	Decimal or integer values ±511

Example **SOURce[1|2]:DATA:DAC VOLATILE, #210 Binary Data**  
 The command above downloads 5 data values (stored in 16 bytes) using the binary block format.  
**SOURce[1|2]:DATA:DAC VOLATILE, 1000, 511, 200, 0, -200, -511**  
 Downloads the data values (511, 200, 0, -200, -511) to address 1000.

**SOURce[1|2]:ARB:EDIT:COPY** Source Specific Command

---

Description Copies a segment of a waveform to a specific starting address.

Syntax **SOURce[1|2]:ARB:EDIT:COPY [<start>|,<length>|,<paste>]]]**

Parameter	<start>	Start address: 0~4095
	<length>	1 ~ 4096
	<paste>	Paste address: 0~4095

Example **SOUR1:ARB:EDIT:COPY 1000, 256, 1257**  
 Copies 256 data values starting at address 1000 and copies them to address 1257.

<b>SOURce[1 2]:ARB:EDIT:DELeTe</b>		Source Specific Command
Description	Deletes a segment of a waveform from memory. The segment is defined by a starting address and length.	
Note	A waveform/waveform segment cannot be deleted when output.	
Syntax	<b>SOURce[1 2]:ARB:EDIT:DELeTe [&lt;START&gt;[,&lt;LENGTh&gt;]]</b>	
Parameter	<START>	Start address: 0~4095
	<LENGTh>	1 ~ 4096
Example	<b>SOURce1:ARB:EDIT:DEL 1000, 256</b> Deletes a section of 256 data points from the waveform starting at address 1000.	

<b>SOURce[1 2]:ARB:EDIT:DELeTe:ALL</b>		Source Specific Command
Description	Deletes all user-defined waveforms from non-volatile memory and the current waveform in volatile memory.	
Note	A waveform cannot be deleted when output.	
Syntax	<b>SOURce[1 2]:ARB:EDIT:DELeTe:ALL</b>	
Example	<b>SOUR1:ARB:EDIT:DEL:ALL</b> Deletes all user waveforms from memory.	

<b>SOURce[1 2]:ARB:EDIT:POINt</b>		Source Specific Command
Description	Edit a point on the arbitrary waveform.	
Note	A waveform/waveform segment cannot be deleted when output.	
Syntax	<b>SOURce[1 2]:ARB:EDIT:POINt [&lt;address&gt; [, &lt;data&gt;]]</b>	

Parameter	<address>	Address of data point: 0~4095
	<data>	Value data: ± 511

**Example**      **SOUR1:ARB:EDIT:POIN 1000, 511**

Creates a point on the arbitrary waveform at address 1000 with the highest amplitude.

**SOURce[1|2]:ARB:EDIT:LINE** Source Specific Command

**Description**      Edit a line on the arbitrary waveform. The line is created with a starting address and data point and a finishing address and data point.

**Note**      A waveform/waveform segment cannot be deleted when output.

**Syntax**      **SOURce[1|2]:ARB:EDIT:LINE**  
**[<address1>,<data>,<address2>,<data2>]]]]**

Parameter	<address1>	Address of data point1: 0~4095
	<data1>	Value data2: ± 511
	<address2>	Address of data point2: 0~4095
	<data2>	Value data2: ± 511

**Example**      **SOUR1:ARB:EDIT:LINE 40, 50, 100, 50**

Creates a line on the arbitrary waveform at 40,50 to 100,50.

**SOURce[1|2]:ARB:EDIT:PROTect** Source Specific Command

**Description**      Protects a segment of the arbitrary waveform from deletion or editing.

**Syntax**      **SOURce[1|2]:ARB:EDIT:PROTect**  
**[<START>,<LENGth>]**

Parameter	<START>	Start address: 0~4095
-----------	---------	-----------------------

<LENGth> 1 ~ 4096

**Example**                    **SOUR1:ARB:EDIT:PROT 40, 50**  
 Protects a segment of the waveform from address 40 for 50 data points.

**SOURce[1|2]:ARB:EDIT:PROTect:ALL**                    Source Specific Command

**Description**            Protects the arbitrary waveform currently in non-volatile memory/ currently being output.

**Syntax**                    **SOURce[1|2]:ARB:EDIT:PROTect:ALL**

**Example**                    **SOUR1:ARB:EDIT:PROT:ALL**

**SOURce[1|2]:ARB:EDIT:UNProtect**                    Source Specific Command

**Description**            Uprotects the arbitrary waveform currently in non-volatile memory/ currently being output.

**Syntax**                    **SOURce[1|2]:ARB:EDIT:UNProtect**

**Example**                    **SOUR1:ARB:EDIT:UNP**

**SOURce[1|2]:ARB:OUTPut**                    Source Specific Command

**Description**            Output the current arbitrary waveform in volatile memory. A specified start and length can also be designated.

**Syntax**                    **SOURce[1|2]:ARB:OUTPut [<STARt>,<LENGth>]**

**Parameter**            <STARt>                    Start address\*: 0~4096  
                          <LENGth>                    Length\*: 0 ~ 4096

\* Start + Length ≤ currently output arbitrary waveform

**Example**                    **SOUR1:ARB:OUTP 20,200**  
 Outputs the current arbitrary waveform in memory.

## Phase

The phase command remotely controls the phase and channel synchronization.

**SOURce[1|2]:PHASe** Instrument Command

Description	Sets the phase.	
Syntax	<b>SOURce[1 2]:PHASe</b> {<phase> <MIN> <MAX>}	
Parameter	phase	-180~180
	min	Sets the phase to the minimum value.
	max	Sets the phase to the maximum value.
Example	<b>SOURce1:PHASe 25</b> Sets the phase of channel 1 to 25°.	
Query Syntax	<b>SOURce[1 2]:PHASe?</b> {MAX MIN}	
Return Parameter	phase	Returns the current phase.
Example	<b>SOURce1:PHASe?</b> 26 Returns the phase of channel 1 as 26°.	

**SOURce[1|2]:PHASe:SYNChronize** Instrument Command

Description	Synchronizes the phase of channel 1 and channel 2. SOURce1 or SOURce2 has not effect on this command.	
Syntax	<b>SOURce[1 2]:PHASe:SYNChronize</b>	
Example	<b>SOURce1:PHASe:SYNChronize</b> Synchronizes the phase of channel 1 and channel 2.	

## Couple

The Couple commands can be used to remotely set the frequency coupling and amplitude coupling.

**SOURce[1|2]:FREQUENCY:COUPLE:MODE** Instrument  
Command

Description	Set the frequency coupling mode.
Syntax	<b>SOURce[1 2]:FREQUENCY:COUPLE:MODE {Off Offset Ratio}</b>
Example	<b>SOURce1:FREQUENCY:COUPLE:MODE Offset</b> Sets the frequency coupling mode to offset.
Query Syntax	<b>SOURce[1 2]:FREQUENCY:COUPLE:MODE?</b>
Return Parameter	Off                      Disables frequency coupling. Offset                    Set frequency coupling to offset mode. Ratio                     Sets frequency coupling to ratio mode.
Example	<b>SOURce1:FREQUENCY:COUPLE:MODE?</b> Off Frequency coupling is turned off.

**SOURce[1|2]:FREQUENCY:COUPLE:OFFSet** Instrument  
Command

Description	Sets the offset frequency when the frequency coupling mode is set to offset.
Syntax	<b>SOURce[1 2]:FREQUENCY:COUPLE:OFFSet {frequency}</b>
Example	<b>SOURce1:FREQUENCY:COUPLE:OFFSet 2khz</b> Sets the offset frequency to 2kHz (the frequency of CH2 minus CH1 is 2kHz).
Syntax	<b>SOURce[1 2]:FREQUENCY:COUPLE:OFFSet?</b>
Example	<b>SOURce1:FREQUENCY:COUPLE:OFFSet?</b> +2.0000E+03



The offset of channel 2 from channel 1 is 2kHz.

**SOURce[1|2]:FREQUency:COUPlE:RATio** Instrument Command

**Description** Sets the frequency coupling ratio when frequency coupling is set to ratio mode.

**Syntax** **SOURce[1|2]:FREQUency:COUPlE:RATio {ratio}**

**Example** **SOURce1:FREQUency:COUPlE:RATio 2**  
Set the CH2 to CH1 frequency ratio to 2.

**Query Syntax** **SOURce[1|2]:FREQUency:COUPlE:RATio?**

**Example** **SOURce1:FREQUency:COUPlE:RATio?**  
+2.0000E+00  
Returns the CH2 to CH1 frequency ratio as 2.

**SOURce[1|2]:AMPlitude:COUPlE:STATe** Instrument Command

**Description** Enables or disables the amplitude coupling.

**Syntax** **SOURce[1|2]:AMPlitude:COUPlE:STATe {ON | Off}**

**Example** **SOURce1:AMPlitude:COUPlE:STATe on**

**Description** Turns amplitude coupling on.

**Query Syntax** **SOURce[1|2]:AMPlitude:COUPlE:STATe?**

<b>Return Parameter</b>	1	ON
	0	Off

**Example** **SOURce1:AMPlitude:COUPlE:STATe?**  
1  
Amplitude coupling has been enabled.

**SOURce[1|2]:TRACK** Instrument Command

Description	Turns tracking on or off.	
Syntax	<b>SOURce[1 2]:TRACk {ON OFF INVerted}</b>	
Example	<b>SOURce1:TRACk ON</b> Turns tracking on. Channel 2 will “track” the changes of channel 1.	
Query Syntax	<b>SOURce[1 2]:TRACk?</b>	
Return Parameter	ON	ON
	OFF	OFF
	INV	INVerted
Example	<b>SOURce1:TRACk?</b> ON Channel tracking is turned on.	

## Sync

A sync output is provided on the front panel SYNC port. All of the standard output functions (except noise) have an associated Sync signal. For Applications where you may not want to output the Sync signal, you can disable the sync connector. The Sync signal may be derived from either output channel in a two-channel instrument. By default the Sync signal is derived from Channel 1.

<b>OUTPut:SYNC</b>		Instrument Command
Description	Enables/Disables or queries the front panel Sync output from the selected channel. The default is set to off.	
Syntax	<b>OUTPut:SYNC {OFF ON}</b>	
Example	<b>OUTPut:SYNC ON</b> Turns the Sync output on.	
Query Syntax	<b>OUTPut:SYNC?</b>	
Return Parameter	1	<b>ON</b>
	0	<b>OFF</b>
Example	<b>OUTPut:SYNC?</b> 1 The Sync output is on.	

<b>OUTPut[1 2]:SYNC:MODE</b>		Instrument Command
Description	This command is able to set the Sync output signal in a different mode.	
Syntax	<b>OUTPut[1 2]:SYNC:MODE {CARRier MARKer}</b>	
Example	<b>OUTP1:SYNC:MODE CARR</b> Synchronizes the Sync output to the carrier signal	

Query Syntax      **OUTPut[1|2]:SYNC:MODE?**

Return Parameter	CARR	The output is synchronized with the carrier.
	MARK	For scan, pulse, and arbitrary waveforms the marker signal is output from the Sync output.

Example      **OUTP1:SYNC:MODE?**  
**CARR**  
 Indicates that the Sync output signal is synchronized to the carrier signal.

**OUTPut[1|2]:SYNC:POLarity**      Instrument Command

Description      This command controls the Sync signal output polarity.

Note      The normal Sync signal polarity is from a TTL low to high level. The inverted Sync signal polarity is from a TTL high to low level.

Syntax      **OUTPut[1|2]:SYNC:POLarity{INVerted|NORMal}**

Example      **OUTP1:SYNC:POLarity INV**  
 Sets the Sync output signal polarity to inverted.

Query Syntax      **OUTPut[1|2]:SYNC:POL?**

Return Parameter	INV	Inverted
	NORM	Normal

Example      **OUTP1:SYNC:POL?**  
**INV**  
 Indicates that the output Sync signal for CH1 is inverted.

<b>OUTPut:SYNC:SOURce</b>		Instrument Command
Description	Outputs the sync signal for the source you have selected.	
Syntax	<b>OUTPut:SYNC:SOURce {CH1 CH2}</b>	
Example	<b>OUTPut:SYNC:SOURce CH1</b> Sets the sync output signal to synchronize to channel 1.	
Query Syntax	<b>OUTPut:SYNC:SOURce?</b>	
Return Parameter	CH1	Synchronize the CH1 signal
	CH2	Synchronize the CH2 signal
Example	<b>OUTP1:SYNC:SOUR?</b> CH1 The Sync output signal is synchronized to CH1.	

## Power Commands

AFG-225P/AFG-125P have the function of output power, can be set 2.5V/3.3V/5V.

<b>VOUTput</b>		Instrument Command
Description	Enables/Disables or queries the front panel power output from the selected channel. The default is set to off.	
Syntax	<b>VOUTput {OFF ON}</b>	
Example	<b>VOUT ON</b> Turns power output on	
Query Syntax	<b>VOUTput?</b>	
Return Parameter	1	<b>ON</b>
	0	<b>OFF</b>
Example	<b>VOUTput?</b> 1 The power output is on	

<b>VSET</b>		Instrument Command
Description	You can set the output voltage	
Syntax	<b>VSET{2.5 3.3 5}</b>	
Example	<b>VSET 2.5</b> The power output of 2.5v	
Query Syntax	<b>VSET?</b>	
Return Parameter	2.5	The voltage is 2.5v
	3.3	The voltage is 3.3v
	5	The voltage is 5v

Example      **VSET?**  
                 2.5

## Save and Recall Commands

Up to 10 different instrument states can be stored to non-volatile memory (memory locations 0~9).

	Instrument Command
<b>*SAV</b>	
Description	Saves the current instrument state to a specified save slot. When a state is saved, all the current instrument settings, functions and waveforms are also saved.
Note	The *SAV command doesn't save waveforms in non-volatile memory, only the instrument state. The *RST command will not delete saved instrument states from memory.
Syntax	<b>*SAV {0 1 2 3 4 5 6 7 8 9}</b>
Example	<b>*SAV 0</b> Save the instrument state to memory location 0.

	Instrument Command
<b>*RCL</b>	
Description	Recall previously saved instrument states from memory locations 0~9.
Syntax	<b>*RCL {0 1 2 3 4 5 6 7 8 9}</b>
Example	<b>*RCL 0</b> Recall instrument state from memory location 0.

	Instrument Command
<b>MEMory:STATe:DELeTe</b>	
Description	Delete memory from a specified memory location.
Syntax	<b>MEMory:STATe:DELeTe {0 1 2 3 4 5 6 7 8 9}</b>
Example	<b>MEM:STAT:DEL 0</b>



Delete instrument state (ARB+Setting) from memory location 0.

	Instrument Command
<b>MEMory:STATe:DELeTe ALL</b>	
Description	Delete memory from all memory locations, 0~9.
Syntax	<b>MEMory:STATe:DELeTe ALL</b>
Example	<b>MEM:STAT:DEL ALL</b> Deletes all the instrument states from memory locations 0~9.

## Error Messages

---

The AFG-200 SERIES has a number of specific error codes. Use the `SYSTEM:ERROR` command to recall the error codes. For more information regarding the error queue.

### Command Error Codes

---

#### -101 Invalid character

An invalid character was used in the command string. Example: #, \$, %.

```
SOURce1:AM:DEPTH MIN%
```

#### -102 Syntax error

Invalid syntax was used in the command string. Example: An unexpected character may have been encountered, like an unexpected space.

```
SOURce1:APPL:SQUare , 1
```

#### -103 Invalid separator

An invalid separator was used in the command string. Example: a space, comma or colon was incorrectly used.

```
APPL:SIN 1 1000 OR SOURce1:APPL:SQUare
```

#### -108 Parameter not allowed

The command received more parameters than were expected. Example: An extra (not needed) parameter was added to a command

```
SOURce1:APPL? 10
```

#### -109 Missing parameter

The command received less parameters than expected. Example: A required parameter was omitted.

```
SOURce1:APPL:SQUare
```

-112 Program mnemonic too long

A command header contains more than 12 characters:

```
OUTP:SYNCHRONIZATION
```

-113 Undefined header

An undefined header was encountered. The header is syntactically correct. Example: the header contains a character mistake.

```
SOUR1:AMM:DEPT MIN
```

-123 Exponent too large

Numeric exponent exceeds 32,000. Example:

```
SOURce[1 | 2]:BURSt:NCYCles 1E34000
```

-124 Too many digits

The mantissa (excluding leading 0's) contains more than 255 digits.

-128 Numeric data not allowed

An unexpected numeric character was received in the command. Example: a numeric parameter is used instead of a character string.

```
SOURce1:BURSt:MODE 123
```

-131 Invalid suffix

An invalid suffix was used. Example: An unknown or incorrect suffix may have been used with a parameter.

```
SOURce1:SWEEp:TIME 0.5 SECS
```

-138 Suffix not allowed

A suffix was used where none were expected. Example: Using a suffix when not allowed.

```
SOURce1:BURSt: NCYCles 12 CYC
```

-148 Character data not allowed

A parameter was used in the command where not allowed. Example: A discrete parameter was used where a numeric parameter was expected.

SOUR1:MARK:FREQ ON

-158 String data not allowed

An unexpected character string was used where none were expected. Example: A character string is used instead of a valid parameter.

SOURce1:SWEEp:SPACing TEN

-161 Invalid block data

Invalid block data was received. Example: The number of bytes sent with the DATA:DAC command doesn't correlate to the number of bytes specified in the block header.

-168 Block data not allowed

Block data was received where block data is not allowed. Example:

SOURce1:BURSt: NCYCles #10

-170~178 expression errors

Example: The mathematical expression used was not valid.

## Execution Errors

---

### -211 Settings conflict;infinite burst changed trigger source to MANUAL

---

Example: The trigger source is changed to Immediate from manual when infinite burst mode is selected.

**-223 Settings conflict; frequency forced duty cycle change**

---

Example: If the frequency is changed and the current Duty cannot be supported at the new frequency, the Duty will be automatically adjusted.

**-221 Settings conflict; frequency reduced for ramp function**

---

Example: When the function is changed to ramp, the Output frequency is automatically reduced if over range.

**-221 Settings conflict; when amplitude coupling, the other channel can't be set to "power" units**

---

Example: The dBm units can not be used when amplitude coupling, the other channel uses high\_z load

**-221 Settings conflict; coupling has forced tracking off.**

---

Example: When coupling mode is enabled, tracking mode is automatically disabled.

**-221 Settings conflict; trace mode doesn't support ARB**

---

Example: When ARB mode is enabled, tracking mode is automatically disabled.

**-221 Settings conflict;The phase function doesn't support ARB,square wave pulse waveforms.**

---

Example:The phase function doesn't support ARB

**-221 Settings conflict;Burst function can not be performed under current setting**

---

Example: A burst waveform cannot be generated with the noise or pulse waveforms.

**-221 Settings conflict;Sweep function can not be performed under current setting.**

---

Example: A sweep waveform cannot be generated with the noise or pulse waveforms.

**-221 Settings conflict;Noise and ARB don't support frequency coupling**

---

Example: The frequency coupling waveform can not be generated with the noise or ARB waveforms.

**-221 Settings conflict;Arb doesn't support phase operation in burst mode.**

---

Example: When burst mode is enabled,the parameter of phase can not be change.

**-221 Settings conflict;Sweep mode doesn't support frequency coupling**

---

Example:When modulation mode is enabled,amplitude coupling mode is automatically disabled.

**-221 Settings conflict;Burst mode doesn't support frequency coupling.**

---

Example: When burst mode is enabled,amplitude coupling mode is automatically disabled.

**-221 Settings conflict;Modulation mode doesn't support frequency coupling.**

---

Example: When modulation is enabled,frequency coupling is automatically disabled.

**-221 Settings conflict;Tracking has forced coupling off.**

---

Example: When tracking mode is enabled,coupling mode is automatically disabled.

**-221 Settings conflict; Coupling can not be performed under current setting**

---

Example: When sweep mode is enabled, coupling mode is automatically disabled.

**-221 Settings conflict; The dBm units can not be used, when load is high\_z.**

---

Example: The dBm units can not be used when the load is high\_z.

**-221 Settings conflict; value clipped to upper limit.**

---

Example: The parameter was set out of range. The parameter is automatically set to the maximum value allowed.

**-221 Settings conflict; modulation function can not be performed under current setting.**

---

Example: A modulated waveform cannot be generated with the noise or pulse waveforms.

**-222 Data out of range; value clipped to lower limit**

---

Example: The parameter was set out of range. The parameter is automatically set to the minimum value allowed.



**-222 Data out of range;amplitude**

---

Example: If the amplitude was set to a value out of range ,it is automatically set to an upper or lower limit.

**-222 Data out of range;offset**

---

Example: If the offset is set to a value out of range,it is automatically set to an upper of lower limit.

**-222 Data out of range;burst count**

---

Example: If the burst count was set to a value out of range, it is automatically set to an upper or lower limit.

**-222 Data out of range;FM deviation clipped to upper limit**

---

Example: If the FM dev was set to a value out of range, it is automatically set to an upper or lower limit.

**-222 Data out of range;Pulse width limited by period**

---

Example: If the width was set to a value out of range,it is automatically set to an upper or lower limit.

**-222 Data out of range;frequency**

---

Example: If the frequency was set to a value out of range,it is automatically set to an upper or lower limit.

## Query Errors

---

### **-410 Query INTERRUPTED**

---

Indicates that a command was received but the data in the output buffer from a previous command was lost.

### **-420 Query UNTERMINATED**

---

The function generator is ready to return data, however there was no data in the output buffer. For example: Using the APPLY command.

### **-430 Query DEADLOCKED**

---

Indicates that a command generates more data than the output buffer can receive and the input buffer is full. The command will finish execution, though all the data won't be kept.

## Arbitrary Waveform Errors

---

### **-770 Nonvolatile arb waveform memory corruption detected**

---

Indicates that a fault (check sum error) has occurred with the non-volatile memory that stores the arbitrary waveform data.

### **-781 Not enough memory to store new arb waveform; bad sectors**

---

Indicates that a fault (bad sectors) has occurred with the non-volatile memory that stores the arbitrary waveform data. Resulting in not enough memory to store arbitrary data.

### **-787 Not able to delete the currently selected active arb waveform**

---

Example: The currently selected waveform is being output and cannot be deleted.

**800 Block length must be even**

---

Example: As block data (SOURCE[1 | 2]:DATA:DAC VOLATILE) uses two bytes to store each data point, there must be an even number of bytes for a data block.

## SCPI Status Register

The status registers are used to record and determine the status of the function generator.

The function generator has a number of register groups:

Questionable Status Registers

Standard Event Status Registers

Status Byte Register

As well as the output and error queues.

Each register group is divided into three types of registers: condition registers, event registers and enable registers.

### Register types

---

Condition Register	The condition registers indicate the state of the function generator in real time. The condition registers are not triggered. I.e., the bits in the condition register change in real time with the instrument status. Reading a condition register will not clear it. The condition registers cannot be cleared or set.
Event Register	The Event Registers indicate if an event has been triggered in the condition registers. The event registers are latched and will remain set unless the *CLS command is used. Reading an event register will not clear it.
Enable Register	The Enable register determines which status event(s) are enabled. Any status events that are not enabled are ignored. Enabled events are used to summarize the status of that register group.

---

## AFG-200 SERIES Status System

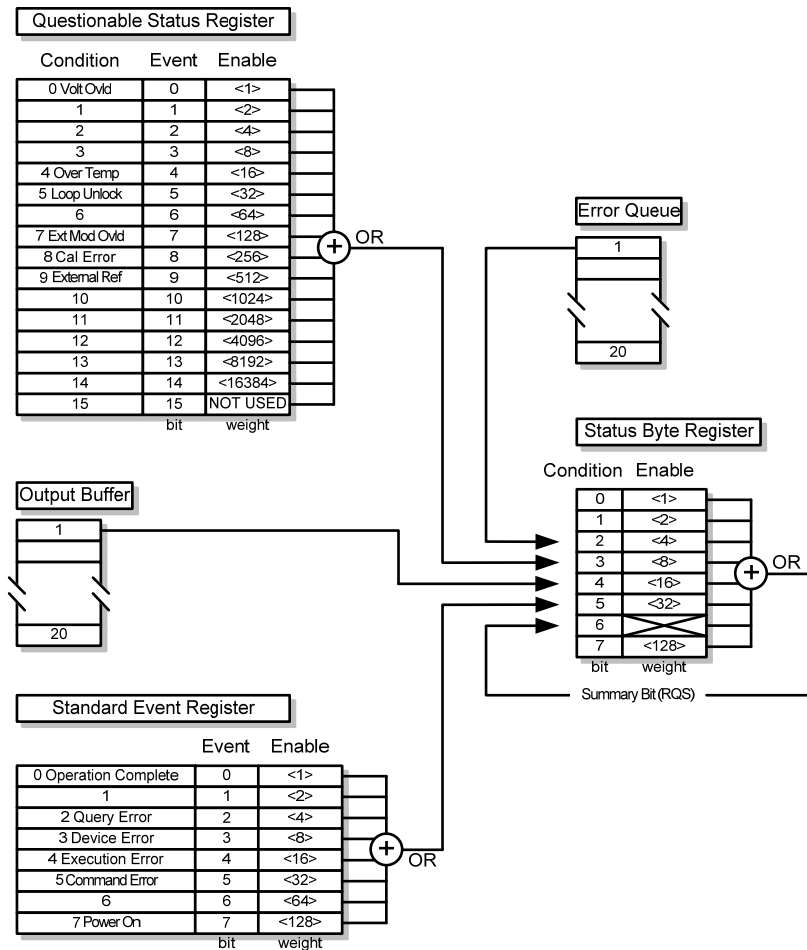

## Questionable Status Register

---

Description	The Questionable Status Registers will show if any faults or errors have occurred.		
Bit Summary	Register	Bit	Bit Weight
	Voltage overload	0	1
	Over temperature	4	16
	Loop unlock	5	32
	Ext Mod Overload	7	128
	Cal Error	8	256
	External Reference	9	512

## Standard Event Status Registers

---

Description	The Standard Event Status Registers indicate when the *OPC command has been executed or whether any programming errors have occurred.
Notes	<p>The Standard Event Status Enable register is cleared when the *ESE 0 command is used.</p> <p>The Standard Event Status Event register is cleared when the *CLS command or the *ESR? command is used.</p>

Bit Summary	Register	Bit	Bit Weight
	Operation complete bit	0	1
	Query Error	2	4
	Device Error	3	8
	Execution Error	4	16
	Command Error	5	32
	Power On	7	128
Error Bits	Operation complete	The operation complete bit is set when all selected pending operations are complete. This bit is set in response to the *OPC command.	
	Query Error	The Query Error bit is set when there is an error reading the Output Queue. This can be caused by trying to read the Output Queue when there is no data present.	
	Device Error	The Device Dependent Error indicates a failure of the self-test, calibration, memory or other device dependent error.	
	Execution Error	The Execution bit indicates an execution error has occurred.	
	Command Error	The Command Error bit is set when a syntax error has occurred.	
	Power On	Power has been reset.	



## The Status Byte Register

Description	<p>The Status Byte register consolidates the status events of all the status registers. The Status Byte register can be read with the *STB? query or a serial poll and can be cleared with the *CLS command.</p> <p>Clearing the events in any of the status registers will clear the corresponding bit in the Status Byte register.</p>		
Notes	<p>The Status byte enable register is cleared when the *SRE 0 command is used.</p> <p>The Status Byte Condition register is cleared when the *CLS command is used.</p>		
Bit Summary	Register	Bit	Bit Weight
	Error Queue	2	4
	Questionable Data	3	8
	Message Available	4	16
	Standard Event	5	32
	Master Summary / Request Service	6	64
Status Bits	Error Queue	There are error message(s) waiting in the error queue.	
	Questionable data	The Questionable bit is set when an “enabled” questionable event has occurred.	
	Message Available	The Message Available bit is set when there is outstanding data in the Output Queue. Reading all messages in the output queue will clear the message available bit.	

---

Standard Event	The Event Status bit is set if an “enabled” event in the Standard Event Status Event Register has occurred.
----------------	---

---

Master Summary/Service Request bit	The Master Summary Status is used with the *STB? query. When the *STB? query is read the MSS bit is not cleared.
------------------------------------	--

The Request Service bit is cleared when it is polled during a serial poll.

---

## Output Queue

---

Description	The Output queue stores output messages in a FIFO buffer until read. If the Output Queue has data, the MAV bit in the Status Byte Register is set.
-------------	--

---

## Error Queue

---

Description	The error queue is queried using the SYSTem:ERRor? command. The Error queue will set the “Error Queue” bit in the status byte register if there are any error messages in the error queue. If the error queue is full the last message will generate a “Queue overflow” error and additional errors will not be stored. If the error queue is empty, “No error” will be returned.
-------------	---

Error messages are stored in the error queue in a first-in-first-out order. The errors messages are character strings that can contain up to 255 characters.

---

# APPDENIX

## AFG-200 Specifications

The specifications apply when the function generator is powered on for at least 30 minutes under +18°C~+28°C.

AFG-200 SERIES models		CH1	CH2
Waveforms		Sine, Square, Ramp, Pulse, Noise, ARB	
Arbitrary Functions			
	Sample Rate	120 MSa/s	
	Repetition Rate	60MHz	
	Waveform Length	4k points	
	Amplitude Resolution	10 bits	
	Non-Volatile Memory	4k points	
Frequency Characteristics			
Range	Sine	1uHz~25MHz	
	Square	1uHz~25MHz	
	Ramp	1MHz	
Resolution		1uHz	
Accuracy	Stability	±20 ppm	
	Aging	±1 ppm, per 1 year	
	Tolerance	≤1 mHz	
Output Characteristics			
Amplitude <sup>[1]</sup>	Range	1mVpp to 2.5Vpp (into 50Ω)	
		2mVpp to 5Vpp (open-circuit)	
	Accuracy	±2% of setting ±1 mVpp (at 1 kHz)	
	Resolution	1mV or 3 digits	
	Flatness	±1% (0.1dB) ≤100kHz ±3% (0.3 dB) ≤5MHz ±5% (0.4 dB) ≤12MHz ±10%(0.9dB) ≤25MHz (sine wave relative to 1kHz)	
	Units	Vpp, Vrms, dBm	
Offset <sup>[1]</sup>	Range	±1.25 Vpk ac +dc (into 50Ω)	
		±2.5Vpk ac +dc (Open circuit)	
	Accuracy	2% of setting + 10mV+ 0.5% of amplitude	
Waveform Output	Impedance	50Ω typical (fixed) > 10MΩ (output disabled)	
	Protection	Short-circuit protected Overload relay automatically disables main output	

<b>Sine wave Characteristics</b>			
Harmonic Distortion	≤-50 dBc	DC ~ 1MHz, Ampl > 1Vpp	
	≤-35 dBc	1MHz ~ 5MHz, Ampl >1Vpp	
	≤-30 dBc	5MHz ~ 25MHz, Ampl >1Vpp	
<b>Square wave Characteristics</b>			
Rise/Fall Time	≤10ns at maximum output. (into 50 Ω load)		
Overshoot	2%		
Asymmetry	1% of period +5 ns		
Variable duty Cycle	1.0% to 99.0% ≤100kHz 10% to 90% ≤ 1MHz 50% ≤ 25MHz		
<b>Ramp Characteristics</b>			
Linearity	< 0.1% of peak output		
Variable Symmetry	0% to 100% (0.1% Resolution)		
<b>Pulse Characteristics</b>			
Period	40ns~2000s		
Pulse Width	20ns~1999.9s		
Overshoot	<2%		
Accuracy	0.1%+20ns		
Jitter	20ppm +10ns		
<b>AM Modulation</b>			
Carrier Waveforms	Sine, Square, Ramp, Pulse,Arb	Sine, Square, Ramp, Pulse,Arb	
Modulating Waveforms	Sine, Square, Triangle, Upramp, Dnramp	Sine, Square, Triangle, Upramp, Dnramp	
Modulating Frequency	2mHz to 20kHz	2mHz to 20kHz	
Depth	0% to 120.0%	0% to 120.0%	
Source	Internal	Internal	
<b>FM Modulation</b>			
Carrier Waveforms	Sine, Square, Ramp, Pulse,Arb	Sine, Square, Ramp, Pulse,Arb	
Modulating Waveforms	Sine, Square, Triangle, Upramp, Dnramp	Sine, Square, Triangle, Upramp, Dnramp	
Modulating Frequency	2mHz to 20kHz (Int)	2mHz to 20kHz (Int)	
Peak Deviation	DC to Max Frequency	DC to Max Frequency	
Source	Internal	Internal	
<b>Sweep</b>			
Waveforms	Sine, Square, Ramp, Pulse,Arb	Sine, Square, Ramp, Pulse,Arb	
Type	Linear or Logarithmic	Linear or Logarithmic	
Start/Stop Freq	1uHz to Max Frequency	1uHz to Max Frequency	
Sweep Time	1ms to 500s	1ms to 500s	
Source	Internal / Manual	Internal / Manual	
<b>FSK</b>			

	Carrier Waveforms	Sine, Square, Ramp,Pulse	Sine, Square, Ramp,Pulse
	Modulating Waveforms	50% duty cycle square	50% duty cycle square
	Modulation Rate	2mHz to 100 kHz (INT)	2mHz to 100 kHz (INT)
	Frequency Range	1uHz to Max Frequency	1uHz to Max Frequency
	Source	Internal	Internal
<b>PM</b>	Carrier Waveforms	Sine, Square, Ramp	Sine, Square, Ramp
	Modulating Waveforms	Sine, Square, Triangle, Upramp, Dnramp	Sine, Square, Triangle, Upramp, Dnramp
	Modulation Frequency	2mHz to 20kHz (Int)	2mHz to 20kHz (Int)
	Phase deviation	0° to 360°	0° to 360°
	Source	Internal	Internal
<b>SUM</b>	Carrier Waveforms	Sine, Square, Ramp,Pulse,Noise	Sine, Square, Ramp,Pulse,Noise
	Modulating Waveforms	Sine, Square, Triangle, Upramp,Dnramp	Sine, Square, Triangle, Upramp,Dnramp
	Modulation Frequency	2mHz to 20kHz	2mHz to 20kHz
	SUM Depth	0% to 100.0%	0% to 100.0%
	Source	Internal	Internal
<b>Sync Output</b>	Type	Sync,Sweep Marker,Burst Marker,or Arbitrary Waveform Marker	
	Assignment	Channel 1 or Channel 2	
	Polarity	Normal or Inverted	
	Level	TTL Compatible into 50 Ω	
	Fan-out	≥4 TTL Load	
	Impedance	50Ω Typical	
<b>Dual Channel Function</b>	Phase	-180° ~180°	-180° ~ 180°
	Square and Pulse	can not be change, Phase is 0°	
	Synchronize phase	Synchronize phase	
	Track	CH2=CH1	CH1=CH2
	Coupling	Frequency(Ratio or Difference)	Frequency(Ratio or Difference)
		Amplitude & DC Offset	Amplitude & DC Offset
	Dsolink	√	√
<b>Burst</b>	Waveforms	Sine, Squa, Ramp,Arb	Sine, Squa,Ramp,Arb

	Frequency	1uHz~15 MHz(sine) 1uHz~15 MHz(Squa) 1uHz~1 MHz (Ramp)	1uHz~15 MHz(sine) 1uHz~15 MHz(Squa) 1uHz~1 MHz (Ramp)
	Burst Count	1 to 65535 cycles or Infinite	1 to 65535 cycles or Infinite
	Start/Stop Phase	-360 to +360	-360 to +360
	Internal Period	1ms to 500s	1ms to 500s
	Gate Source	External Trigger	External Trigger
	Trigger Source	Single or Internal Rate	Single or Internal Rate
Trigger Delay	N-Cycle, Infinite	0s to 655350ns	0s to 655350ns
Save/Recall		10 Groups of Setting Memories	
Power(only AFG-125P/225P)			
	Output Voltage	(2.5V/3.3V/5V)±5%	
	Output Current	0.6A	
Interface		USB (Device)	
General Specifications			
	Power Source	DC 5V	
	Power Consumption	10 W (Max)	
	Operating Environment	Temperature to satisfy the specification : 18 ~ 28 °C Operating temperature : 0 ~ 40 °C Relative Humidity: < 80%, 0 ~ 40 °C Installation category : CAT II	
	Operating Altitude	2000 Meters	
	Storage Temperature	-10~70 °C, Humidity: ≤70%	
	Dimensions (WxHxD)	215(W) x 35 (H) x 107(D) mm	
	Weight	Approx. 1kg	
	Accessories	GTL-101× 1(only AFG-125/125P) GTL-105A×2 (only AFG-125P)	GTL-101×2(only AFG-225/225P) GTL-105A×2(only AFG-225P)
		Quick Start Guide ×1 CD (user manual + software) ×1 Power adapter×1	

**NOTES:**

[1] If only used USB power supply

Amplitude	1mVpp to 2Vpp (into 50Ω) 2mVpp to 4Vpp (open-circuit)
Offset	±1 Vpk ac +dc (into 50Ω) ±2 Vpk ac +dc (Open circuit)