

36000A Series
High power
Electronic Load
Operation manual

Material Contents Declaration

(材料含量宣称)

(Part Name) 零件名称	Hazardous Substance (有毒有害物质或元素)					
	铅(Pb)	汞(Hg)	镉(Cd)	六价铬 (Cr6+)	多溴联 苯(PBB)	多溴二苯醚 (PBDE)
PCBA (印刷电路装配件)	X	○	X	○	○	○
Electrical part not on PCBA's 未在PCBA上的电子零件	X	○	X	○	○	○
Metal parts 金属零件	○	○	○	X	○	○
Plastic parts 塑料零件	○	○	○	○	X	X
Wiring 电线	X	○	○	○	○	○
Package 封装	X	○	○	○	○	○

对销售之日的所售产品,本表显示, PRODIGIT 供应链的电子信息产品可能包含这些物质。注意:在所售产品中可能会也可能不会含有所有所列的部件。This table shows where these substances may be found in the supply chain of Prodigit electronic information products, as of the date of sale of the enclosed product. Note that some of the component types listed above may or may not be a part of the enclosed product. ○: 表示该有毒有害物质在该部件所有均质材料中的含量均在SJ/T 11363-2006 标准规定的限量要求以下。○: Indicates that the concentration of the hazardous substance in all homogeneous materials in the parts is below the relevant threshold of the SJ/T 113632006 standard. ×: 表示该有毒有害物质至少在该部件的某一均质材料中的含量超出SJ/T 11363-2006 标准规定的限量要求。×: Indicates that the concentration of the hazardous substance of at least one of all homogeneous materials in the parts is above the relevant threshold of the SJ/T 11363-2006 standard.

Note(注释):

1. Prodigit has not fully transitioned to lead-free solder assembly at this moment ; However, most of the components used are RoHS compliant.

(此刻, Prodigit 并非完全过渡到无铅焊料组装;但是大部份的元器件一至于RoHS的规定。)

2. The product is labeled with an environment-friendly usage period in years.

The marked period is assumed under the operating environment specified in the product specifications.

(产品标注了环境友好的使用期限(年)。所标注的环境使用期限假定是在此产品定义的使用环境之下。)



Example of a marking for a 10 year period:

(例如此标制环境使用期限为10年)

SAFETY SUMMARY

The following general safety precautions must be observed during all phases of operation, service, and repair of this instrument. Failure to comply with these precautions or with specific warnings elsewhere in this manual violates safety standards of design, manufacture, and intended use of the instrument. PRODIGIT assumes no liability for the *customer's failure to comply with these requirements*.

GENERAL

This product is a Safety Class 1 instrument (provided with a protective earth terminal). The protective features of this product may be impaired if it is used in a manner not specified in the operation instructions.

ENVIRONMENTAL CONDITIONS

This instrument is intended for indoor use in an installation category I, pollution degree 2 environments. It is designed to operate at a maximum relative humidity of 80% and at altitudes of up to 2000 meters. Refer to the specifications tables for the ac mains voltage requirements and ambient operating temperature range.

BEFORE APPLYING POWER

Verify that the product is set to match the available line voltage and the correct fuse is installed.

GROUND THE INSTRUMENT

This product is a Safety Class 1 instrument (provided with a protective earth terminal). To minimize shock hazard, the instrument chassis and cabinet must be connected to an electrical ground. The instrument must be connected to the ac power supply mains through a three conductor power cable, with the third wire firmly connected to an electrical ground (safety ground) at the power outlet. Any interruption of the protective (grounding) conductor or disconnection of the protective earth terminal will cause a potential shock hazard that could result in personal injury.

FUSES

Only fuses with the required rated current, voltage, and specified type (normal blow, time delay, etc.) should be used. Do not use repaired

Fuses or short circuited fuse holder. To do so could cause a shock or fire hazard.

DO NOT OPERATE IN AN EXPLOSIVE ATMOSPHERE.

Do not operate the instrument in the presence of flammable gases or fumes.

KEEP AWAY FROM LIVE CIRCUITS.

Operating personnel must not remove instrument covers. Component replacement and internal adjustments must be made by qualified service personnel. Do not replace components with power cable connected. Under certain conditions, dangerous voltages may exist even with the power cable removed. To avoid injuries, always disconnect power, discharge circuits and remove external voltage sources before touching components.

DO NOT SERVICE OR ADJUST ALONE.

Do not attempt internal service or adjustment unless another person, capable of rendering first aid and resuscitation, is present.

DO NOT EXCEED INPUT RATINGS.

This instrument may be equipped with a line filter to reduce electromagnetic interference and must be connected to a properly grounded receptacle to minimize electric shock hazard. Operation at line voltages or frequencies in excess of those stated on the data plate may cause leakage currents in excess of 5.0 mA peak.

DO NOT SUBSTITUTE PARTS OR MODIFY INSTRUMENT.

Because of the danger of introducing additional hazards, do not install substitute parts or perform any unauthorized modification to the instrument. Return the instrument to a PRODIGIT ELECTRONICS Sales and Service Office for service and repair to ensure that safety features are maintained.

Instruments which appear damaged or defective should be made inoperative and secured against unintended operation until they can be repaired by qualified service personnel.



EC DECLARATION OF CONFORMITY

We **Prodigit Electronics Co., Ltd.** declares under our own responsibility that the product

DC Electronic Load

(Model No.:

36250A, 36260A, 36350A, 36360A)

satisfies all the technical relations application to the product within the scope of council:

Directive: 2014/30/EU; 2014/35/EU; 2015/863/EU; 2012/19/EU

The above product is in conformity with the following standards or other normative documents

Harmonized Standard :

EN 61010-1: 2010+A1:2019

EN IEC 61010-2-030:2021+A11:2021

EN 61326-1:2013

EN 61326-2-1:2013

Reference Basic Standards :

Emission:

EN 55011: 2016+A1: 2020 Class A

EN 55032: 2015+A1:2020

EN 61000-3-2: 2014

EN 61000-3-3: 2013

Immunity:

EN 61000-4-2: 2009

EN 61000-4-3: 2006+A2:2010

EN 61000-4-4: 2012

EN 61000-4-5: 2014+A1:2017

EN 61000-4-6: 2014

EN 61000-4-8: 2010

EN 61000-4-11: 2020

Company Name : Prodigit Electronics Co., Ltd.

**Company Address : 8F, No.88, Baojhong Rd., Sindian District, New Taipei City,
Taiwan.**

Person is responsible for marking this declaration:



Manufacturer/Importer
Signature:

Date: **2022/10/20** Name:

Dean Wang

Dean Wang
R&D Assistant Manager



UK Declaration of Conformity

We Prodigit Electronics Co., Ltd. declares under our own responsibility that the product

DC Electronic Load

(Model No.:

36250A, 36260A, 36350A, 36360A)

satisfies all the technical relations application to the product within the scope of council:

Directive: Electromagnetic Compatibility Regulations 2016; Electrical Equipment (Safety) Regulations 2016; the Restriction of the Use of Certain Hazardous Substances in Electrical and Electronic Equipment Regulations 2012

The above product is in conformity with the following standards or other normative documents

Harmonized Standard :

BS EN 61010-1:2010+A1:2019 ;BS EN IEC 61010-2-030:2021+A11:2021

BS EN 61326-1: 2013 ; BS EN 61326-2-1: 2013

Reference Basic Standards :

Emission:

BS EN 55011: 2016+A1: 2020 Class A

BS EN 55032: 2015+A1:2020

BS EN 61000-3-2: 2014

BS EN 61000-3-3: 2013

Immunity:

BS EN 61000-4-2: 2009

BS EN 61000-4-3: 2006+A2:2010

BS EN 61000-4-4: 2012

BS EN 61000-4-5: 2014+A1:2017

BS EN 61000-4-6: 2014

BS EN 61000-4-8: 2010

BS EN 61000-4-11: 2020

Company Name : Prodigit Electronics Co., Ltd

Company Address : 8F, No.88, Baojhong Rd., Sindian District, New Taipei City, Taiwan

Person is responsible for marking this declaration:



Manufacturer/Importer
Signature:

Dean Wang

Date: **2022/10/20**

Name: Dean Wang
R&D Assistant Manager

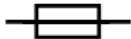
SAFETY SYMBOLS**Direct current (DC)****Alternating current (AC)****Both direct and alternating****Three-phase alternating current****Protective earth (ground)****On (Supply)****Off (Supply)****Fuse****Caution ! Refer to this manual before using the meter.****Caution, risk of electric shock**

CAT IV – Is for measurements performed at the source of the low-voltage installation.

CAT III – Is for measurements performed in the building installation.

CAT II – Is for measurements performed on circuits directly connected to the low-voltage installation.

CAT I – Is for measurements performed on circuits not directly connected to Mains.

36000A series module load operation manual

Table of Contents

Chapter 1 Introduction	11
1-1. GENERAL DESCRIPTION	11
1-2. FEATURES	17
1-3. STANDARD ACCESSORIES	17
1-4. OPTION	17
1-5. SPECIFICATIONS 1	18
1-6. SPECIFICATIONS 2	19
Chapter 2 Installation	21
2-1. INSPECTION	21
2-2. CHECK LINE VOLTAGE	21
2-3. GROUNDING REQUIREMENTS	21
2-4. ENVIRONMENTAL REQUIREMENTS	22
2-5. REPAIR	22
2-6. CLEANING	22
2-7. OBSERVE PRECAUTIONS FOR HANDLING ELECTROSTATIC SENSITIVE DEVICES	23
2-8. INSTALLATION AND PREPARATION	23
2-9. CHECKING WHETHER THE POWER IS ON OR OFF	24
2-10. CONNECTING TO THE DUT	24
2-11. CONNECTING TO THE LOAD INPUT TERMINALS ON THE REAR PANEL	25
2-12. WIRE/CABLE GUIDE	26
2-13. POWER ON / OFF THE LOAD AND DUT	26
2-14. GPIB & RS232 INTERFACE OPTION	26
2-15. RS232 INTERFACE OPTION	27
2-16. GPIB INTERFACE OPTION	27
2-17. USB INTERFACE OPTION	28
2-18. LAN INTERFACE OPTION	28
2-19. I/O INTERFACE	28
2-20. LOAD CURRENT SLEW RATE SETTING	29
2-21. LOAD WIRE INDUCTANCE	31
Chapter 3 Operation	34
3-1. 36000A SERIES SIZE DESCRIPTION	34
3-2. INSTRUCTIONS	37
3-3. 36000A SERIES OPERATING INSTRUCTIONS (1)	77
3-4. 36000A SERIES SYSTEM OPERATING INSTRUCTIONS (2)	78
3-5. 36000A SERIES SYSTEM OPERATING INSTRUCTIONS (3)	79
3-6. INITIAL SETTING OF 36000A SERIES LOAD	92
3-7. PROTECTION FEATURES	94
Chapter 4 Communication Interface programming operation	96
4-1. INTRODUCTION	96
4-2. THE SUMMARY OF RS232 INTERFACE AND COMMAND	96
4-3. 36000A SERIES COMMUNICATION INTERFACE PROGRAMMING COMMAND LIST1	98
4-4. 36000A SERIES COMMUNICATION INTERFACE PROGRAMMING COMMAND LIST 2	103
4-5. THE DESCRIPTION OF ABBREVIATION	109
4-6. COMMUNICATION INTERFACE PROGRAMMING COMMAND SYNTAX DESCRIPTION	109
4-7. COMMUNICATION INTERFACE PROGRAMMING COMMAND DESCRIPTION	110
Chapter 5 Applications	121

5-1.	LOCAL SENSE CONNECTIONS	121
5-2.	REMOTE SENSE CONNECTIONS	122
5-3.	CONSTANT CURRENT MODE APPLICATION	123
5-4.	CONSTANT VOLTAGE MODE APPLICATION	126
5-5.	CONSTANT RESISTANCE MODE APPLICATION	127
5-6.	CONSTANT POWER MODE APPLICATION	128
5-7.	APPLICATIONS WITH CURRENT LIMITING OR POWER LIMITING FUNCTION CV MODE OPERATION (CHARGING DEVICE)	130
5-8.	APPLICATIONS WITH CURRENT LIMITING OR POWER LIMITING FUNCTION CV MODE OPERATION (DISCHARGING DEVICE)	131
5-9.	APPLICATION WITH SWITCHING FROM CP MODE TO CV MODE OPERATION (BATTERY DISCHARGE)	132
5-10.	PARALLEL OPERATION	133
5-11.	ZERO-VOLT LOADING APPLICATION	134
5-12.	36000A SERIES ELECTRONIC LOAD OCP, OPP, SHORT OPERATION FLOW CHART	135
5-13.	POWER SUPPLY OCP TESTING	136
5-14.	POWER SUPPLY OPP TESTING	139
5-15.	SHORT TESTING	142
5-16.	THE MPPT ALGORITHM FOR 36000A SERIES DC LOAD	144
5-17.	BATTERY DISCHARGE TEST	146

Figures

Fig 1-1.1 36250A power contour	Fig 1-1.2 36260A power contour	11
Fig 1-1.3 36350A power contour	Fig 1-1.4 36360A power contour	12
Fig 1-2 Constant Current mode		12
Fig 1-3 Constant Resistance mode		13
Fig 1-4 Constant Voltage mode		13
Fig 1-5 Constant Power mode		14
Fig 1-6 Dynamic Wave form		14
Fig 1-7 Rise Time Transition Limitation		16
Fig 2-1 36000A Series AC Input Connection		21
Fig 2-2 36000A Series GPIB & RS232 interface		27
Fig 2-3 36000A Series RS232 interface		27
Fig 2-4 36000A Series GPIB interface		27
Fig 2-5 36000A Series USB interface		28
Fig 2-6 36000A Series LAN interface		28
Fig 2-7 36000A Series I/O interface		28
Fig 2-8 The relationship of load current load ON/OFF, load level and output voltage of DC power supply at Turn ON		30
Fig 2-9 Waveform example: Generate unstable oscillation		32
Fig 2-10 Length of wiring		33
Fig 3-1 36000A Series SIZE description		34
Fig 3-2 36000A Series Rear Panel		36
Fig 3-3 36000A Series front Panel		37
Fig 3-4 typical connection of 36000A series load module		74
Fig 3-5 An equivalent circuit in terms of the current monitor		75
Fig 3-6 (Correct) Connections to an oscilloscope		75
Fig 3-7 (Wrong) Connections to an oscilloscope		76
Fig 3-8 Analog programming example		77
Fig 3-9 STORE (EDIT) MODE OPERATIONO FLOW-CHART		89
Fig 3-10 TEST MODE OPERATION FLOW-CHA		91
Fig 4-1 RS232 INTERFACE CONNECTION OF REAR PANEL		97
Fig 5-1 Local voltage sense connections		121
Fig 5-2 Remote voltage sense connections		122
Fig 5-3 constant CURRENT mode application		123
Fig 5-4 Dynamic load current with independent programmed Rise/Fall slew rate		125
Fig 5-5 Constant Voltage mode application		126
Fig 5-6 Constant Resistance mode Application		127
Fig 5-7 CONSTANT POWER MODE APPLICATION		129
Fig 5-8 CC+CV mode operation application		131
Fig 5-9 Application of CP to CV operation mode		132
Fig 5-10 36000A series load parallel operation		133
Fig 5-11 Zero-Volt loading connection		134
Fig 5-12 36000A series electronic load OCP, OPP, and SHORT operation flow chart		135
Fig 5-13 TYPE 1 Battery Discharge Figure		146
Fig 5-14 TYPE 2 Battery Discharge Figure		146
Fig 5-15 TYPE 4 Battery Discharge Figure		147
Fig 5-16 TYPE 4 Battery Discharge Figure		148

Tables

Table 1-1 36000A Series Specifications	18
Table 1-1A 36000A Series Specification	20
Table 3-1 36000A series Size description	35
Table 3-2 36250A initialize	92
Table 3-3 36260A initialize	92
Table 3-4 36350A initialize	93
Table 3-5 36360A initialize	93
Table 4-1 REMOTE CONTROL SETTING COMMAND SUMMARY	98
Table 4-2 REMOTE CONTROL QUERY COMMAND SUMMARY	99
Table 4-3 REMOTE CONTROL LIMIT COMMAND SUMMARY	99
Table 4-4 STAGE COMMAND SUMMARY	100
Table 4-5 SYSTEM COMMAND SUMMARY	101
Table 4-6 MEASURE COMMAND SUMMARY	101
Table 4-7 Auto sequence command list	102
Table 4-8 BATTERY TEST SET COMMAND	102
Table 4-1B Communication Interface programming setting command summary	103
Table 4-2B Communication Interface programming QUERY command summary	104
Table 4-3B Communication Interface programming limit command summary	105
Table 4-4B STAGE COMMAND SUMMARY	106
Table 4-5B SYSTEM COMMAND SUMMARY	107
Table 4-6B MEASURE COMMAND SUMMARY	107
Table 4-7B Auto sequence command list	108
Table 4-9 GPIB COMMAND TERMINATOR	109
Table 4-10 module for each series	116
Table 4-11 register of PROT status	118
Table 4-12 MODEL NUMBER	119

Chapter 1 Introduction

1-1. General description

The 36000A series Electronic Load is designed to test, evaluation and burn-in of DC power supplies and batteries.



The 36000A series electronic load can be operated for manual and GPIB operation. The power contour of 36000A series Electronic Load is shown in Fig 1-1.1~1-1.4.

The PRODIGIT 36000A series high power electronic Load can be controlled locally at the front panel or remotely via computer over the GPIB/RS232/USB/LAN. Constant Current (CC) mode, Constant Resistance (CR) mode, and Constant Voltage (CV) mode and Constant Power (CP) mode. The wide range dynamic load with independent rise and fall current slew rate and analog programming input with arbitrary wave-form input is available in Constant Current mode.

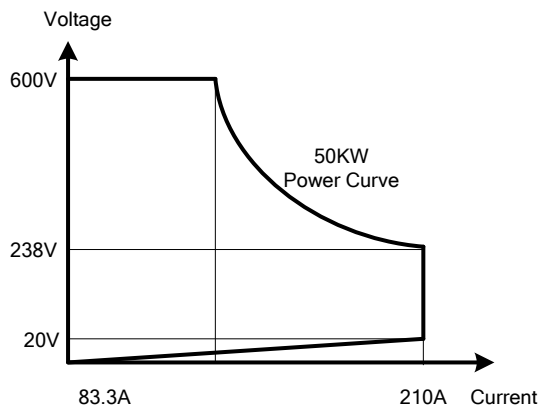

Fig 1-1.1 36250A power contour

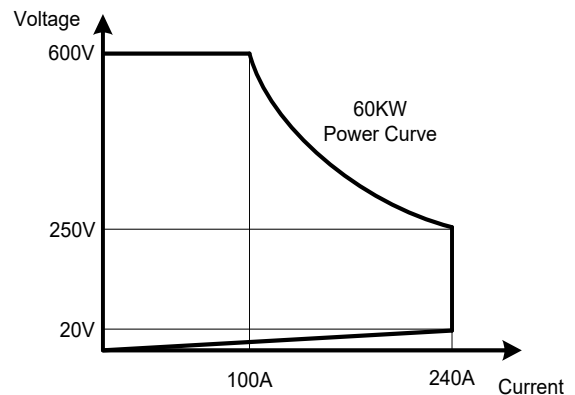

Fig 1-1.2 36260A power contour

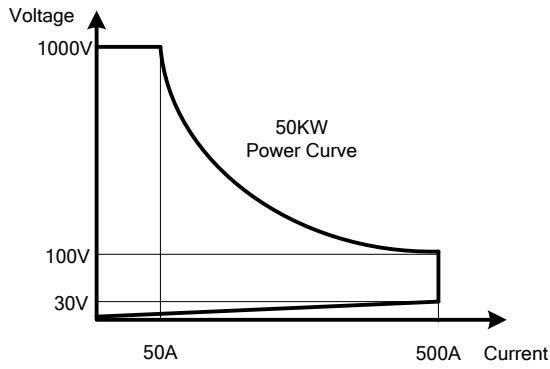

Fig 1-1.3 36350A power contour

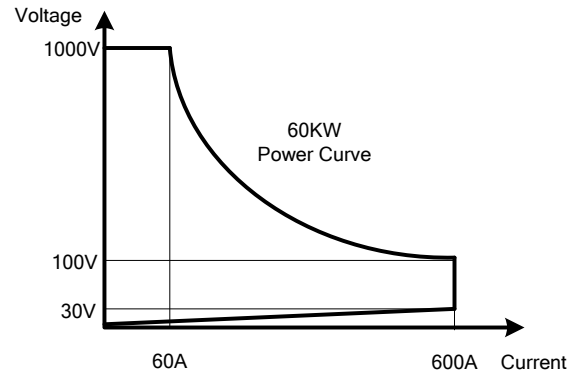

Fig 1-1.4 36360A power contour

1.1.1. CC Mode

With the operating mode of Constant Current, the 36000A series electronic load will sink a current in accordance with the programmed value regardless of the input voltage (see Fig.1-2).

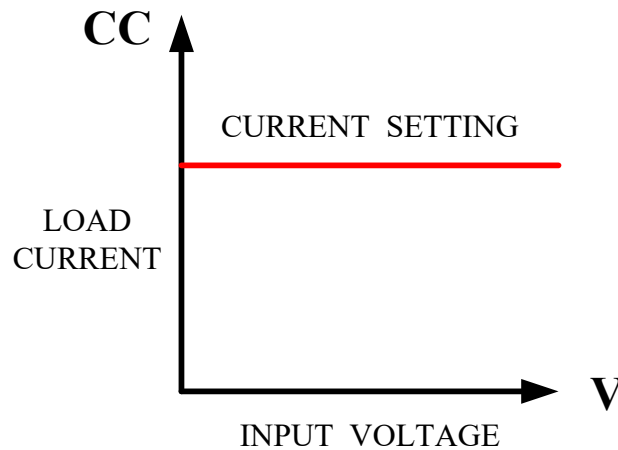

Fig 1-2 Constant Current mode

1.1.2. CR Mode:

At Constant Resistance mode, the 36000A series Electronic Load will sink a current linearly proportional to the load input voltage in accordance with the programmed resistance setting (see Fig 1-3).

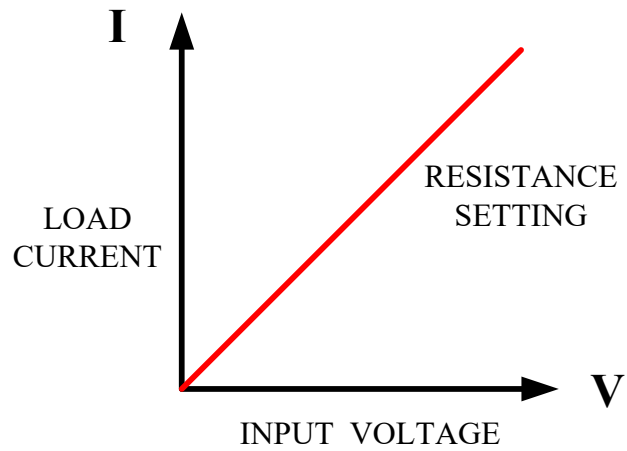

Fig 1-3 Constant Resistance mode

1.1.3. CV Mode:

At Constant Voltage mode, the 36000A series Electronic Load will attempt to sink enough current until the load input voltage reaches the programmed value (see Fig 1-4).

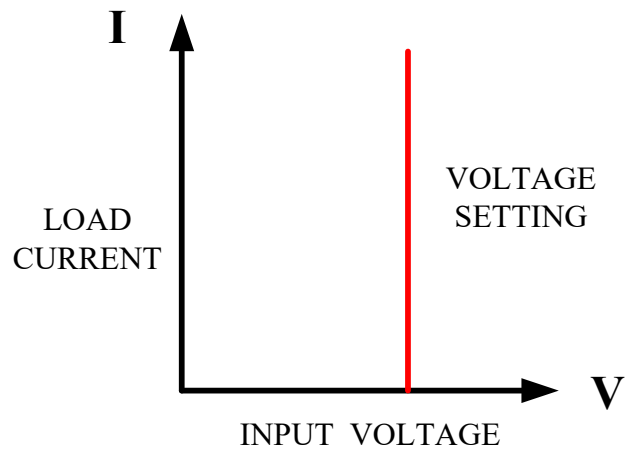

Fig 1-4 Constant Voltage mode

1.1.4. CP Mode:

At Constant Power mode, the 36000A series Electronic Load will attempt to sink load power (load voltage * load current) in accordance with the programmed power. (See Fig 1-5).

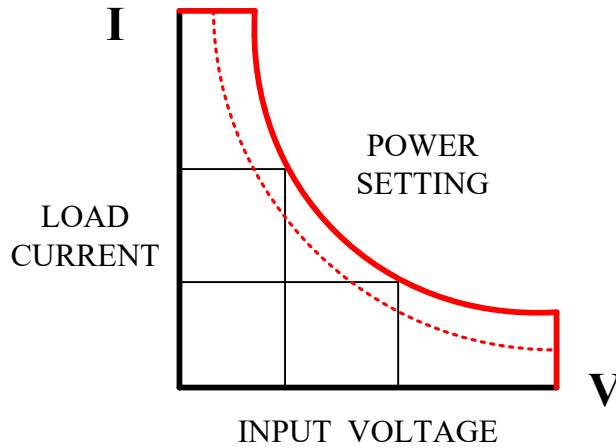

Fig 1-5 Constant Power mode

1.1.5. Dynamic Waveform Definition

Along with static operation the 36000A Series Electronic Load are built with a Dynamic mode for operation in Constant Current (CC), Constant Resistance (CR) or Constant Power (CP). This allows the test engineer to simulate real world pulsing loads or implement a load profile that varies with time.

A dynamic waveform can be programmed from the front panel of the 36000A Electronic Load. The user would first set a High and low value of load current using the Level button. The Dynamic Setting then allows for the rise and fall time between these 2 current values to be adjusted. The time period that the waveform is high (Thigh) along with the time period that the waveform is low (Tlow) can also be set.

The dynamic waveform is illustrated below in Fig 1-6.

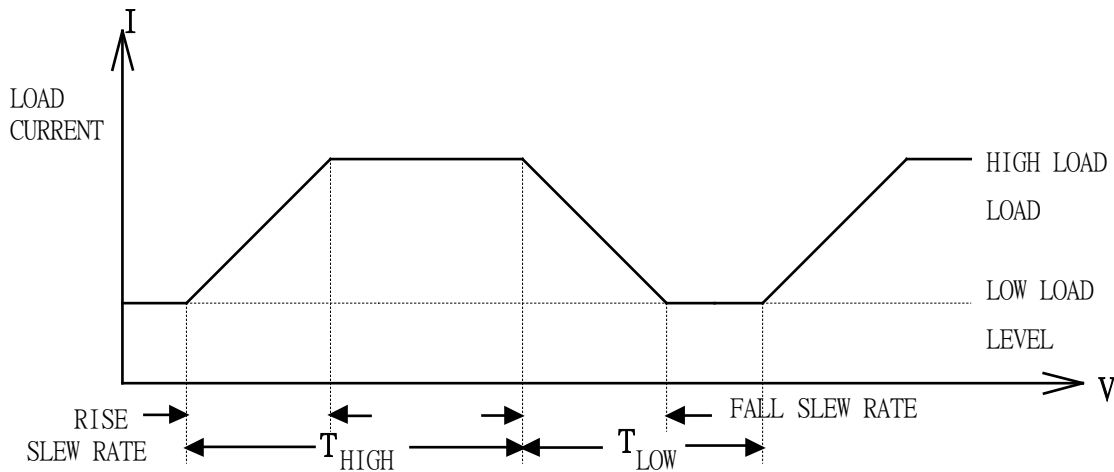

Fig 1-6 Dynamic Wave form

The dynamic waveform can also be set up via the optional computer interface. Dynamic waveform settings made from the front panel of the load module can also be saved in the memory of the 36000A series Electronic Load. For the store/recall procedure and the computer command set please refer to the relevant operating manual for the 36000A series Electronic Load. Further dynamic waveform definitions are:

- The period of dynamic waveform is $T_{high} + T_{low}$
- The dynamic frequency = $1 / (T_{high} + T_{low})$
- The duty cycle = $T_{high} / (T_{high} + T_{low})$

Example1:

363XXA Series, Dynamic up to 50 KHz frequency

Dynamic highest frequency 50 KHz = $0.02\text{ms} = 20\mu\text{s}$

Setting THIGH=10 μs , TLOW=10 μs , THIGH+TLOW=20 μs

$CCH - CCL / SR \leq 10\mu\text{s}$

Setting CCH=30A, CCL=10A

$(30 - 10) / 2.5\text{A} / \mu\text{s} \leq 10\mu\text{s}$

$8\mu\text{s} \leq 10\mu\text{s}$, Compliance with frequency 50KHz

Example2:

Setting THIGH=10 μs , TLOW=10 μs , THIGH+TLOW=20 μs

$CCH - CCL / SR \leq 10\mu\text{s}$

Setting CCH=50A, CCL=0A

$(50 - 0) / 2.5\text{A} / \mu\text{s} = 20\mu\text{s}$, $20\mu\text{s} > 10\mu\text{s}$, It's not compliance the frequency 50 KHz

The analogue programming input also provides a convenient method of implementing a dynamic waveform. Please see the section 3.1.26 titled 'Analog Programming Input' for further information.

1.1.6. Slew Rate

Slew rate is defined as the change in current or voltage over time. A programmable slew rate allows for a controlled transition from one load setting to another. It can be used to minimize induced voltage drops on inductive power wiring, or to control induced transients on a test device (such as would occur during power supply transient response testing).

In cases where the transition from one setting to another is large, the actual transition time can be calculated by dividing the voltage or current transition by the slew rate. The actual transition time is defined as the time required for the input to change from 10% to 90% or from 90% to 10% of the programmed excursion.

In cases where the transition from one setting to another is small, the small signal bandwidth (of the load) limits the minimum transition time for all programmable slew rates. Because of this limitation, the actual transition time is longer than the expected time based on the slew rate, as shown in Figure 1-7

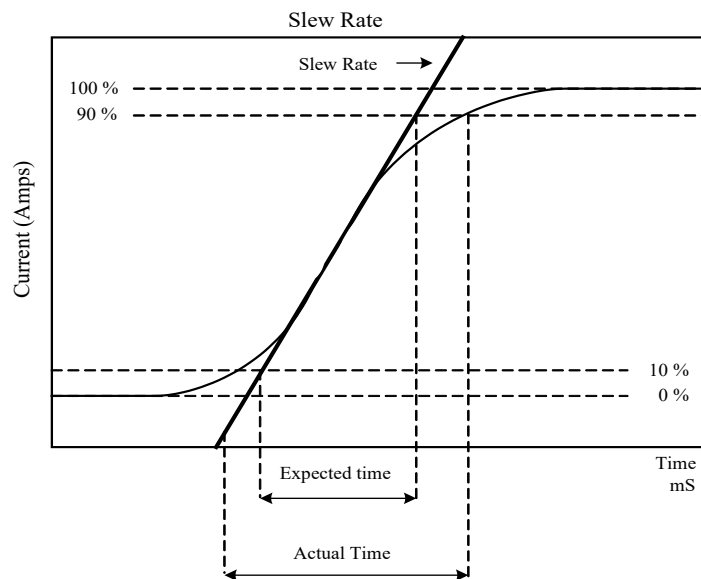

Fig 1-7 Rise Time Transition Limitation

Therefore, both minimum transition time and slew rate must be considered when determining the actual transition time.

Following detail description is excluding in specification sheet.

The minimum transition time for a given slew rate as about a 30% or greater load change, The slew rate increases from the minimum transition time to the Maximum transition time at a 100% load change. The actual transition time will be either the minimum transition time, Or the total slew time (transition divided by slew rate), whichever is longer.

EX: 36260A 600V/240A/60000W (CCH - CCL >240Ax 30%)

Use the following formula to calculate the minimum transition time for a given slew rate min transition time=72A/slew rate (in amps/second).

$$6\mu\text{S} (72\text{A}/12) \times 0.8(10\% \sim 90\%) = 4.8\mu\text{S}$$

Use the following formula to calculate the maximum transition time for a given slew rate max transition time=240/slew rate (in amps/second).

$$20\mu\text{S} (240\text{A}/12) \times 0.8(10 \sim 90\%) = 16\mu\text{S}$$

EX. CCH=64A, CCL=0A Slew Rate =16A, the expected time is 4.26 μS but the actual Transition Time Will be limited to 4.8 μS

$$5.33\mu\text{S} (64/12) \times 0.8(10\% \sim 90\%) = 4.26\mu\text{S}$$

1-2. Features

The main features of the 36000A series of load are highlighted below.

- CC, CR, CV, CP, Dynamic, and Short Operating Mode.
- Remote control via a choice of computer interfaces.
- High accuracy & resolution with 16-bit voltage and current meter.
- Built in pulse generators up to 50 kHz for dynamic loading.
- Independently adjustable current rise and fall times.
- Short circuit test with current measurement.
- Dedicated over current and overpower protection test functions.
- Programmable voltage sense capability.
- Full protection from overpower, over-temperature, overvoltage.
- Analogue programming input for tracking an external signal
- Current Monitor with BNC (non-isolated) socket.
- Digital Calibration
- Advance Fan speed control
- Ability to save load set-ups via the mainframe memory (150 store/recall locations)
- Auto sequence function allowing test routines to be set from the mainframe

1-3. Standard Accessories

a	36000A Series operation manual.....	1PCs
b	BANANA PLUGS.....	2PCs
c	BNC – BNC CABLE.....	1PCs
d	Hex Head Cap Screw M8*1.25 L=35mm NI.....	4PCs
e	Round Head Phillips Screw M8*1.25 L=35mm NI.....	4PCs
f	NUT M8X1.25 NI.....	4PCs
g	WASHER INSIDE DIA-8.5 OUTSIDE.....	8PCs
h	Power Cord.....	1PC

1-4. Option

- 1.4.1. GPIB+RS232 interface
- 1.4.2. RS232 interface
- 1.4.3. GPIB interface
- 1.4.4. USB interface + USB DRIVER CD
- 1.4.5. LAN interface + LAN DRIVER CD
- 1.4.6. GPIB cable 1 M
- 1.4.7. GPIB cable 2 M
- 1.4.8. USB TYPE A TO TYPE B cable 1.8 M.

1-5. Specifications 1

AC INPUT	LINE	200Vac~230Vac ± 10%
	FREQUENCY	50/60 Hz ±3Hz
	PROTECT	BREAKER
	MAX. POWER CONSUMPTION	36250A 5450VA 36260A 6200VA 36350A 5450VA 36360A 6200VA

Model	Power	Voltage	Current	Dimension(HxWxD)	WEIGHT
36250A	50K	600	210	1360 mm x 853 mm x 766 mm	510 Kg
36260A	60K	600	240	1513 mm x 853 mm x 766 mm	630 Kg
36350A	50K	1000	500	1360 mm x 853 mm x 766 mm	510 Kg
36360A	60K	1000	600	1513 mm x 853 mm x 766 mm	630 Kg

Table 1-1 36000A Series Specifications

1-6. Specifications 2

Model	36250A		36260A		36350A		36360A	
Power	50KW	50KW	60KW	60KW	50KW	50KW	60KW	60KW
Current	0 ~ 21A	0 ~ 210A	0 ~ 24A	0 ~ 240A	0 ~ 50A	0 ~ 500A	0 ~ 60A	0 ~ 600A
Voltage	0 ~ 600V		0 ~ 600V		0 ~ 1000V		0 ~ 1000V	
Min. Operating Voltage	20V @ 210A		20V @ 240A		30V @ 500A		30V @ 600A	
Protections								
Over Power Protection(OPP)	105%		105%		105%		105%	
Over Current Protection(OCP)	105%		105%		104%		104%	
Over Voltage Protection(OVP)	105%		105%		104%		104%	
Over Temp Protection(OTP)	YES		YES		YES		YES	
Constant Current Mode								
Range *1	21A	210A	24A	240A	52.5A	500A	60A	600A
Resolution	0.35mA	3.5mA	0.4mA	4mA	0.875mA	8.75mA	1mA	10mA
Accuracy	± 0.05% of (Setting + Range)							
Constant Resistance Mode								
Range	8571Ω ~ 2.857Ω	2.857Ω ~ 0.0477Ω	7500Ω ~ 2.5Ω	2.5Ω ~ 0.0417Ω	2280Ω ~ 1.9Ω	1.9Ω ~ 0.02Ω	2000Ω ~ 1.666Ω	1.666Ω ~ 0.01668Ω
Resolution	5.83uS	47.7uΩ	6.66uS	41.7uΩ	8.7uS	32uΩ	10uS	27.833uΩ
Accuracy	± 0.2% of (Setting + Range)							
Constant Voltage Mode								
Range	0 ~ 600V		0 ~ 600V		10 ~ 1000V		10 ~ 1000V	
Resolution	10mV		10mV		16mV		16mV	
Accuracy	± 0.05% of (Setting + Range)							
Constant Power Mode								
Range	5.25KW	50KW	6KW	60KW	5KW	50KW	6KW	60KW
Resolution	0.0875W	0.875W	0.1W	1W	0.0875W	0.875W	1W	1W
Accuracy *2	± 0.1% of (Setting + Range)							
Constant Voltage + Current Limit Mode								
Range	600V	210A	600V	240A	1000V	500A	1000V	600A
Resolution	10mV	3.5mA	10mV	4mA	16mV	8.75mA	16mV	10mA
Accuracy	± 0.05% of (Setting + Range)	± 1.0% of (Setting + Range)	± 0.05% of (Setting + Range)	± 1.0% of (Setting + Range)	± 0.05% of (Setting + Range)	± 1.0% of (Setting + Range)	± 0.05% of (Setting + Range)	± 1.0% of (Setting + Range)
Constant Voltage + Power Limit Mode								
Range	600V	50KW	600V	60KW	1000V	50KW	1000V	60KW
Resolution	10mV	0.875W	10mV	1W	16mV	0.8W	16mV	1W
Accuracy	± 0.05% of (Setting + Range)	± 1.0% of (Setting + Range)	± 0.05% of (Setting + Range)	± 1.0% of (Setting + Range)	± 0.05% of (Setting + Range)	± 1.0% of (Setting + Range)	± 0.05% of (Setting + Range)	± 1.0% of (Setting + Range)

Model	36250A		36260A		36350A		36360A	
MPPT Mode								
Algorithm	P & O							
Load mode	CV							
P&O interval	1000ms-6000ms ; resolution 1s							
Dynamic Mode								
Timing								
Thigh & Tlow	0.050-9.999 / 99.99 / 999.9 / 9999mS							
Resolution	0.001 / 0.01 / 0.1 / 1mS							
Accuracy	1uS/10uS/100uS/1mS + 50ppm							
Slew rate	16.8mA~1.05A/uS	168mA~10.5A/uS	19.2mA~1.2A/uS	192mA~12A/uS	0.04A~2.5A/uS	0.4A~25A/uS	0.048A~3A/uS	0.48A~30A/uS
Resolution	4.2mA/uS	42mA/uS	4.8mA/uS	48mA/uS	0.01A/uS	0.1A/uS	0.012A/uS	0.12A/uS
Min. Rise Time	20uS(typical)							
Current								
Range	0~21A	21~210A	0~24A	24~240A	0~50A	50~500A	0~60A	60~600A
Resolution	0.35mA	3.5mA	0.4mA	4mA	0.875mA	8.75mA	1mA	10mA
Measurement								
Voltage Read Back								
Range (5 Digital)	0~60V	60~600V	0~60V	60~600V	0~100V	100~1000V	0~100V	100~1000V
Resolution	1mV	10mV	1mV	10mV	1.6mV	16mV	1.6mV	16mV
Accuracy	± 0.025% of (Reading + Range)							
Current Read Back								
Range (5 Digital)	0~21A	21~210A	0~24A	24~240A	0~50A	50~500A	0~60A	60~600A
Resolution	0.35mA	3.5mA	0.4mA	4mA	0.875mA	8.75mA	1mA	10mA
Accuracy	± 0.05% of (Reading + Range)							
Power Read Back								
Range (5 Digital)	5KW	50KW	6KW	60KW	5KW	50KW	6KW	60KW
Resolution	0.1W	1W	0.1W	1W	0.1W	1W	0.1W	1W
Accuracy *3	± 0.06% of (Reading + Range)							
General								
Short Circuit								
Current	210A		240A		500A		600A	
Load ON Voltage	0.4~ 100V		0.4~ 100V		10.4 ~ 200V		10.4 ~ 200V	
Load OFF Voltage	0 ~ 99V		0 ~ 99V		0 ~ 198.4V		0 ~ 198.4V	
Operating Temperature *4	0~40°C							
AC INPUT								
LINE	200Vac~230Vac ± 10%							
PROTECT	BREAKER							
MAX. POWER CONSUMPTION	5450VA		6200VA		5450VA		6200VA	
FREQUENCY	50/60 Hz ± 3Hz							

Note *1 : The range is automatically or forcing to range II only in CC mode

Note *2 : If the operating voltage is higher than 600V, the accuracy specification is 0.5% F.S.

Note *3 : Power F.S. = Vrange F.S. x Irange F.S.

Note *4 : Operating temperature range is 0~40°C, All specifications apply for 25°C±5°C, Except as noted

Note *5 : 1000V Model Specifications apply only for load input voltage > 50V

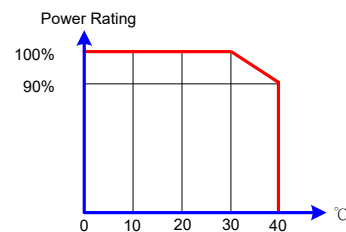

Table 1-1A 36000A Series Specification

Chapter 2 Installation

2-1. Inspection

The 36000A Series high power load was carefully inspected before shipment. If instrument damage has occurred during transport, please inform Prodigit's sales and service office or representative. Your 36000A Series high power load was shipped with a power cord for the type of Terminal blocks used at your location. If the appropriated cord was not included, please contact your nearest Prodigit sales office to obtain the correct cord. Refer to "check line voltage "to check the line voltage is 200V~230Vac.

2-2. Check line voltage

The 36000A Series high power load can operation with 200 Vac ~230Vac input as indicated on the label on the rear panel.

Make sure that the factory check mark corresponds to your nominal line voltage. Skip this procedure if the label is corrected marked.

- 2.2.1. With the 36000A Series load power OFF, disconnect the power cord.
- 2.2.2. Refer the drawing on the rear panel of 36000A Series high power load in Fig 2-1.

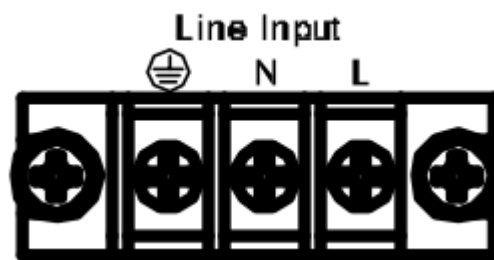

Fig 2-1 36000A Series AC Input Connection

2.2.3 Circuit breaker

The circuit breaker is an electrical safety device designed to protect an electrical circuit from damage caused by an overcurrent or short circuit. Its basic function is to interrupt current flow to protect equipment and to prevent the risk of fire. The circuit breaker can be reset manually to resume normal operation.



2-3. Grounding requirements



SHOCK HAZARD

1. It is requested to use the 3Pin plug connector only for 36000A Series mainframe to out of danger when electric leakage. And the complete and proper grounded is necessary.

2. The 36000A Series high power load is equipped with three conductor cable which plugs in an appropriate receptacle to ground the instrument's cover.

2-4. Environmental requirements

- Indoor use.
- Measurement Category I.
- Pollution Degree 2.
- Relative Humidity 80% Max.
- Ambient Temperature 0 to +40°C
- Altitude up to 2000m.
- The equipment is not for measurements performed for CAT II, III and IV.
- Transient Overvoltage on the mains supply can be 2500V.

2-5. Repair

If the instrument is damaged, please attach a tag to the instrument to identify the owner and indicated the require service or repairing. And inform the Prodigit sales and service office or representative.

2-6. Cleaning

The dust on the load can be removed with a brush, and the dust on the vent below the front panel can be removed with a vacuum cleaner.

You can use a soft or damp cloth to clean the outer casing of the product. The inside of the product must be cleaned with a low-pressure air gun, or sent to the original factory or agent for cleaning.

* Please clean regularly every year

Use a soft or slightly damp cloth to clean this product.



BEFORE you clean the unit, switch the mains power off and disconnect the input lead.

- Please do NOT use any organic solvent capable of changing the nature of the plastic such as benzene or acetone.
- Please ensure that no liquid is allowed to penetrate this product.

2-7. Observe precautions for handling electrostatic sensitive devices

Analog Programming Input and Imonitor BNC terminal is ESD (electrostatic discharge) Sensitive device. Electrostatic charges as high as 4000 V readily accumulates on the human Body and Test equipment and can discharge without detection.

Although the features proprietary ESD protection circuitry, permanent damage may occur on devices subjected to high energy electrostatic discharges.

Therefore, proper ESD precautions are recommended to avoid performance degradation or loss of functionality.

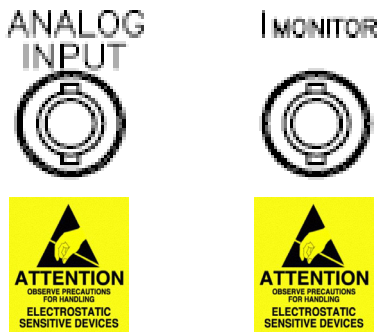

2-8. Installation and Preparation

- Turn the Power switch off
- Check that the AC power line meets the nominal input rating of the DC LOAD.
- Connect the power cord to the AC INPUT.
- Check that the power cord is connected correctly.
- Connect the power cord plug to a properly grounded outlet.

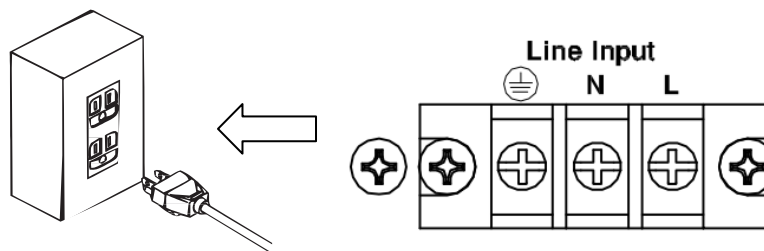

Connect to a properly grounded outlet.

2-9. Checking Whether the Power Is On or Off



- Check that the power cord is connected correctly.
- Check that nothing is connected to the DC INPUT (load input) terminals on the rear panels.
- Turn the POWER switch on
- If you notice strange sounds, unusual odors, fire, or smoke around or from inside the DC Load, turn the POWER switch off, or remove the power cord plug from the outlet.
- Press the side of the POWER switch to turn the power off.

2-10. Connecting to the DUT



Risk of damage.

- Do not connect the DUT to the load input terminals while the product's load is turned on.
- Do not invert the polarity when connecting. An overcurrent might flow when the load is Turned on.
- To avoid overheating, observe the following precaution.
- Use the supplied screws to connect the cables with crimping terminals.

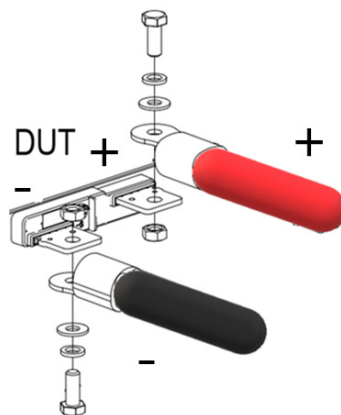

2-11. Connecting to the load input terminals on the rear panel



WARNING

Risk of electric shock.

- Be sure to attach the cover for the load input terminals on the rear panel.
- Turn the load off.
- Turn off the output of the DUT.
- Connect the DUT to the load input terminals on the rear panel.
- Do not invert the polarity when connecting.
- Connect the positive (+) input terminal on the load generator to the high Potential Output of the DUT & Load unit, and connect the negative (-) polarity input terminal on The load generator to the low Potential output of the DUT & Load unit.
- This completes the connections.

Note: Avoid equipment damaged, don't input the DC voltage standard output to the DC Load input terminal, if calibration voltage meter required, please input the DC voltage standard to the Vsense input.

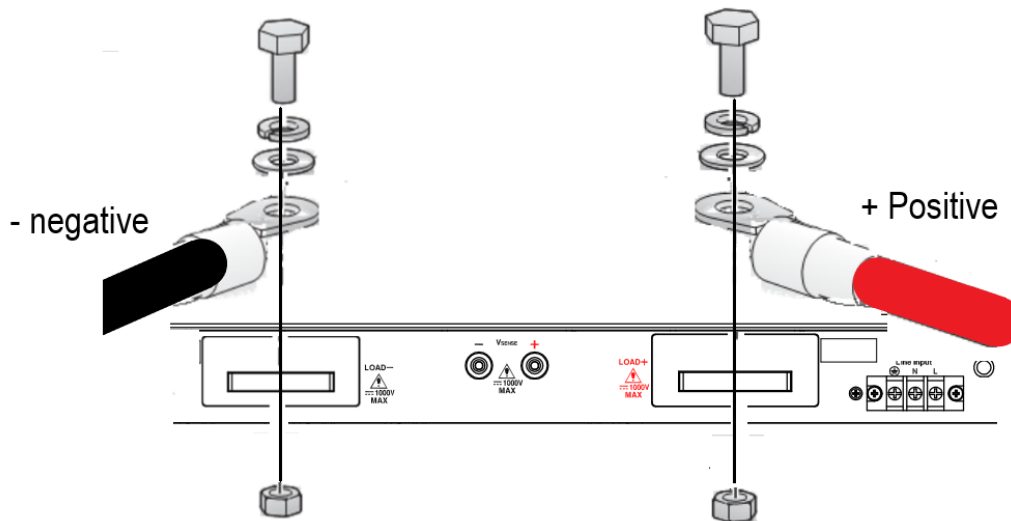

2-12. Wire/Cable Guide

The following table provides a guide to the current carrying capability (ampacity) of Both Metric and AWG sizes. Metric sizes are expressed as a cross sectional areas (CSA). If in any doubt of a cables ampacity it is recommended that you ask your Cable supplier.

Wire Size AWG	Ampacity (A)	CSA (mm ²)	Notes: Ratings for AWG-sized wires derived from MIL-W-5088B. Ratings for metric-sized wires derived from IEC Publication
22	5.0	-----	Ampacity of aluminium wire is approximately 84% of that listed for copper wire.
20	8.33	-----	
---	10	0.75	When two or more wires are bundled together, ampacity for each wire must be reduced to the following percentages:
18	15.4	-----	
---	13.5	1	
16	-----	-----	
---	16	1.5	
14	31.2	-----	2 conductors 94%
---	25	2.5	3 conductors 89%
12	40	-----	4 conductors 83%
---	32	4	5 conductors 76%
10	55	-----	4. Maximum temperatures: Ambient = 50° C Conductor = 105° C
---	40	6	
8	75	-----	
---	63	10	
6	100	-----	
4	135	-----	

2-13. Power ON / Off the Load and DUT

Power ON Sequence

1. Turn the POWER switch on the Load.
2. Turn the POWER switch on the DUT.

Power OFF Sequence

1. Turn the POWER switch off the DUT.
2. Turn the POWER switch off the Load.

2-14. GPIB & RS232 interface option

- 2.14.1. GPIB + RS232 interface is on the rear panel of 36000A Series Mainframe for application GPIB or RS232.
- 2.14.2. GPIB and RS232 interface can only be used at the same time, to Change the interface must reboot unit.
- 2.14.3. GPIB connection with three important limitations as Described below:
 - 2.14.3.1 The maximum number of devices including the controller is no More than 15.
 - 2.14.3.2 The maximum length of all cable is no more than 2 meters times The Number of devices connected together, up to 20 meters Maximum.
 - 2.14.3.3 RS232 Female Block connections on the back panel, the Connecting Device and the computer RS232 port to one-way Connection.

(Note: Not 2-wire connection, the detail as 4-2).

- 2.14.4. Fig 2-2 shows the RS232 connector (Female) on the rear panel Connects 36000A Series Mainframe to RS232 port of computer in one By one Configuration. The RS232 BAUD-RATE can be set in the front Panel, it Will be lit the GPIB Address when press the “SYSTEM” button. Press it again, it will be lit the BAUD-RATE.



Fig 2-2 36000A Series GPIB & RS232 interface

2-15. RS232 interface option

Fig 2-3 shows the RS232 connector (Female) on the rear panel connects 36000A Series mainframe to RS232 port of computer in one by one configuration. The RS232 BAUD-RATE can be set in the front panel, it will be lit the GPIB address when press the “SYSTEM” button. Press it again, it will be lit the BAUD-RATE.



Fig 2-3 36000A Series RS232 interface

2-16. GPIB interface option

- 2.16.1 The maximum number of devices including the controller is no more than 15.
 2.16.2 The maximum length of all cable is no more than 2 meters times the Number of Devices connected together, up to 20 meters maximum.



Fig 2-4 36000A Series GPIB interface

2-17. USB interface option

Fig 2-5 shows the USB connector in the rear panel of 36000A Series mainframe. Please Refer Appendix B.

The USB card chip PL2303TA only supports operating systems below Win10 (Including).



Fig 2-5 36000A Series USB interface

2-18. LAN interface option

Fig 2-6 shows the LAN connector in the rear panel of 36000A Series mainframe. Please refer Appendix C.

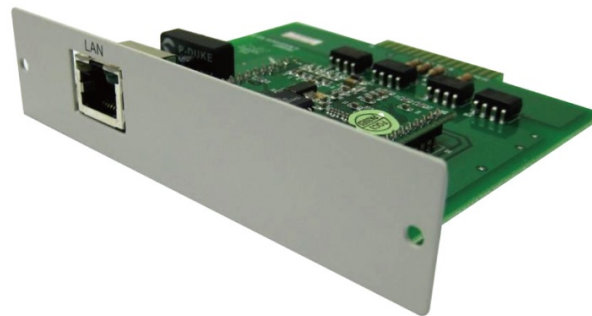

Fig 2-6 36000A Series LAN interface

2-19. I/O interface

36000A series I/O Interface with Vsense, Analog Programming Input, Imonitor, Instructions please refer to Chapter 3-5.



Fig 2-7 36000A Series I/O interface

2-20. Load current slew rate setting

What is the load current slew rate during load current level change, power supply turn ON/OFF switch between ON, and OFF? The 36000A series Electronic load provides all of the above load current slew rate in controllable condition, the rise and fall current slew rate can be set independently from front panel operation or remote programming.

The slew rate determines a rate at which the current changes to a new programmed value. The slew rate can be set at the front panel or via GPIB on the rear panel of 36000A Series high power load.

The rise and fall slew rate can be independently programmed from 192mA/usec to 12A/usec (36260A Load) in the 240A current range and from 19.2mA/usec to 1.2A/usec in the 24A current range. This allows a independent controlled transition from Low load current level to High load current level (Rise current slew rate) or from High load current level to Low load current level(Fall current slew rate) to minimize induced voltage drops on the inductive wiring, or to control induced transients on the est. device (power supply transient response testing).

This controllable load current slew rate feature also can eliminate the overload current Phenomenon And emulate the actual load current slew rate at turn ON the power supply under test. Fig 2-8 Shows the load current slew rate is according to the power supply's Output Voltage, load level Setting and Load ON/OFF switch. So, you could do all items of Power Supply testing task by using Constant current mode only, it can significantly improve The Testing quality and process as well as Efficiency.

There are two load current range in 36000A Series Load, Range I and Range II, the slew rate of range I, range II, RISE/FALL slew rate are listed in chapter 1-4 specifications.

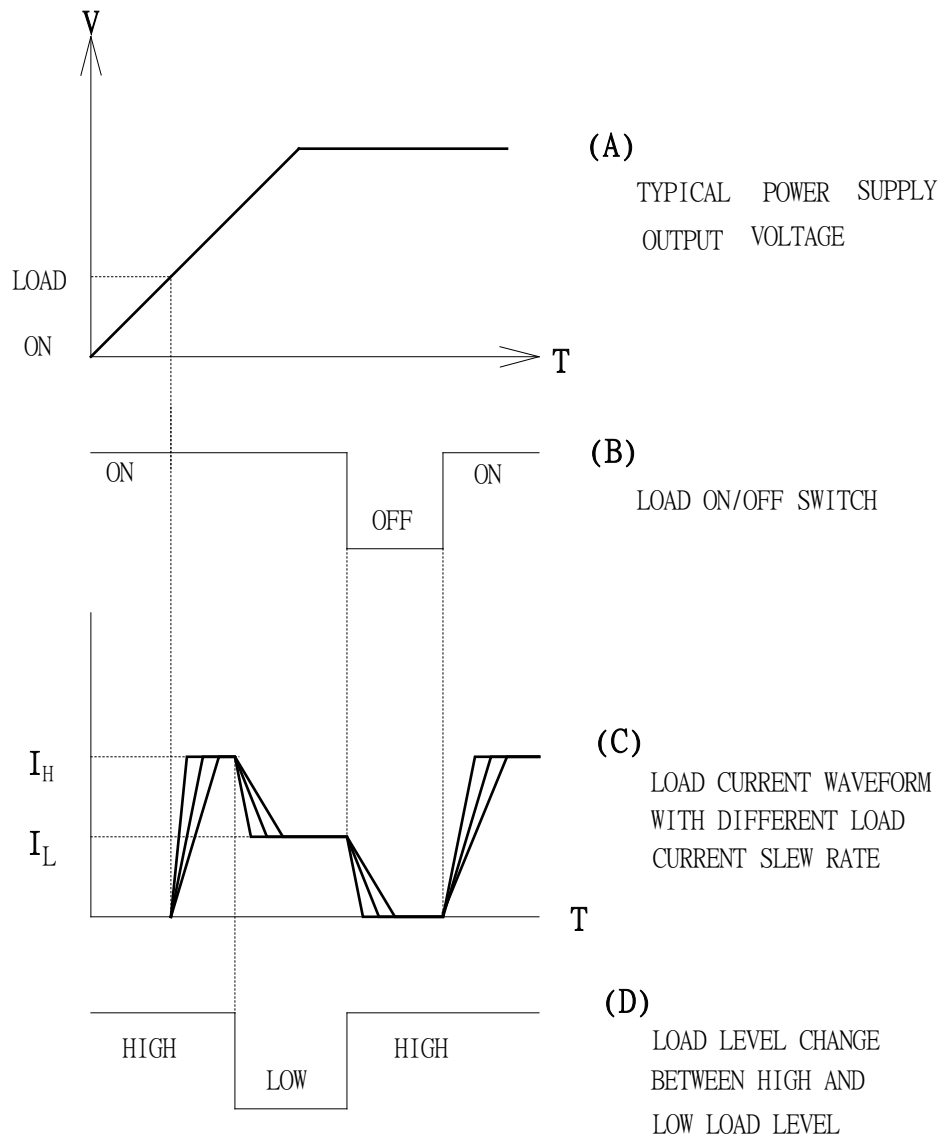
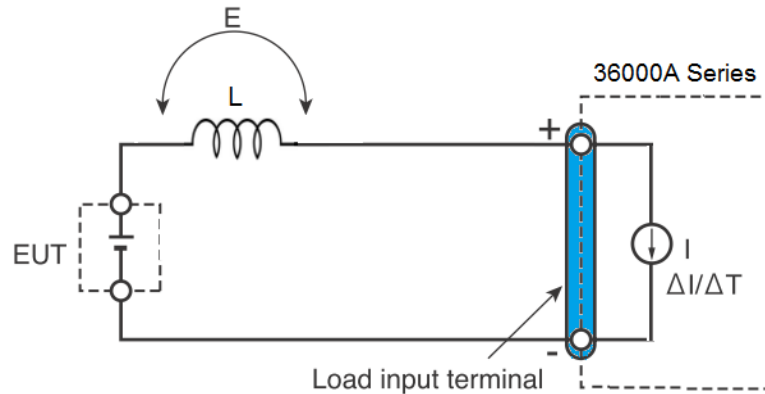

Fig 2-8 The relationship of load current load ON/OFF, load level and output voltage of DC power supply at Turn ON

2-21. Load wire inductance

The load wiring has an inductance (L). When the current (I) varies in short time period, It generates a large voltage at both ends of the wiring cable. This voltage applies to all of the load input terminals of the 36000A series when the impedance of the EUT is relatively small. The voltage generated by the load wire inductance (L) and the current variation (I) is expressed using the following equation.



$$E = L \times (\Delta I / \Delta T)$$

E: Voltage generated by the wire inductance

L: Load wire inductance

ΔI: Amount of Current variation

ΔT: Variation period of current

In general, the wire inductance can be measured approximately 1 μH per 1 meter. If the 10 meters of Load wires is connected between the EUT and the electronic load (36000A Series) with the current Variation of 2 A/μs, the voltage generated by the wire inductance will be 20 V.

The negative polarity of the load input terminal is the reference potential of the external control signal, Therefore, the device connected to the external control terminal may get malfunctioned.

When operating under the constant voltage (CV) mode or constant resistance (CR) mode or constant power (CP), the load current is varied by the voltage at the load input terminal, so the operation can be affected easily by the generated voltage.

The wiring to the EUT should be twisted and the shortest as possible.

If the load wire is long or has a large loop, the wire inductance is increased. Consequently, the Current variation that results when switching occurs will cause a large voltage drop.

When the value of instantaneous voltage drops under the minimum operating voltage depends on The generated voltage at the load input terminal, the response of recovery will be extensively Delayed.

In such event, the electronic load (36000A) may generate unstable oscillation.

In such condition, the input voltage may exceed the maximum input voltage and Cause damage to The 36000A Series.

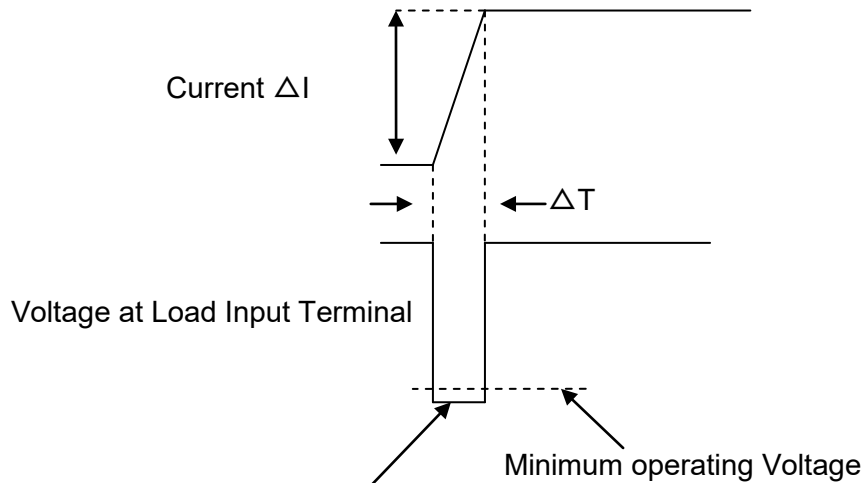

When the Voltage drops under minimum operating voltage, the electronic load may generate unstable

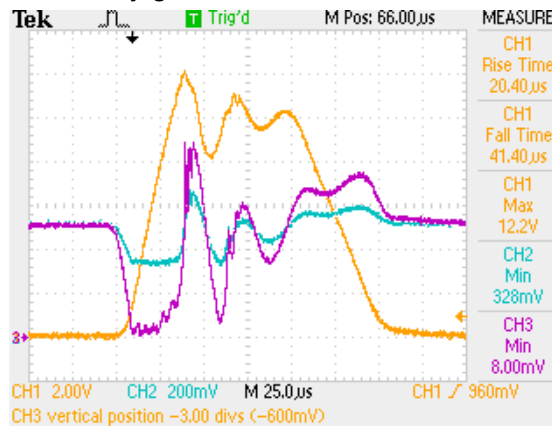

CH1=Imonitor
 CH2=Power Supply output Voltage (x10)
 CH3= LOAD Input Voltage (x10)

Fig 2-9 Waveform example: Generate unstable oscillation

You must be careful especially when the slew rate setting is high or switching is performed using Large currents through parallel operation.

To prevent problems, connect the 36000A series and the equipment under test using the shortest Twisted Wire possible to keep the voltage caused by inductance between the minimum operating Voltage and the maximum input voltage range or set a low slew rate.

If the high-speed response operation is not required, decrease the slew rate setting.

In such settings, the value of DI / DT will be decreased, accordingly the generated voltage will be Reduced even the inductance of load wiring cannot be reduced.

In the case of DC operation also, the phase delay of the current may cause instability in the 36000A Series Control inducing oscillation. In this case also, connect the 36000A series and the equipment Under test using the shortest twisted wire possible.

If only DC operation is required, a capacitor and a resistor may be connected to the load input Terminal as shown in Fig. 2-10 to alleviate oscillation. In this case, use the capacitor within its Allowable ripple current.

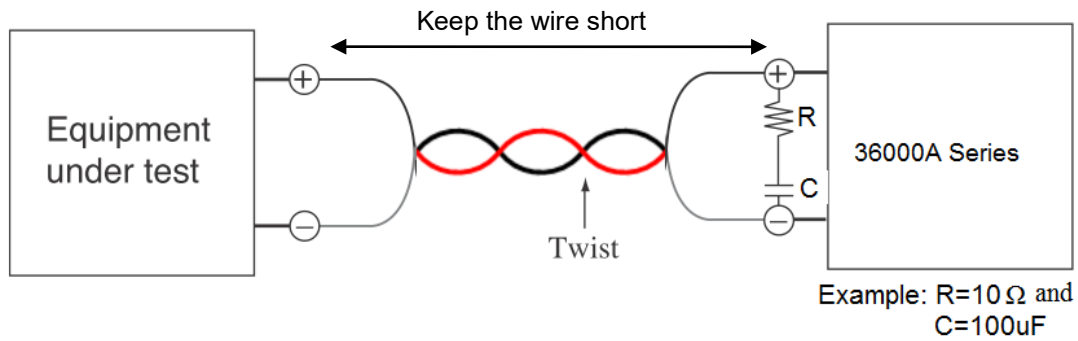

Fig 2-10 Length of wiring

Chapter 3 Operation

This chapter describes the front panel function and operation of each 36000A Series load, the memory Store/Recall; please refer to the mainframe's operation manual for mainframe store/recall and GPIB/RS232/LAN/USB programming.

3-1. 36000A Series Size description

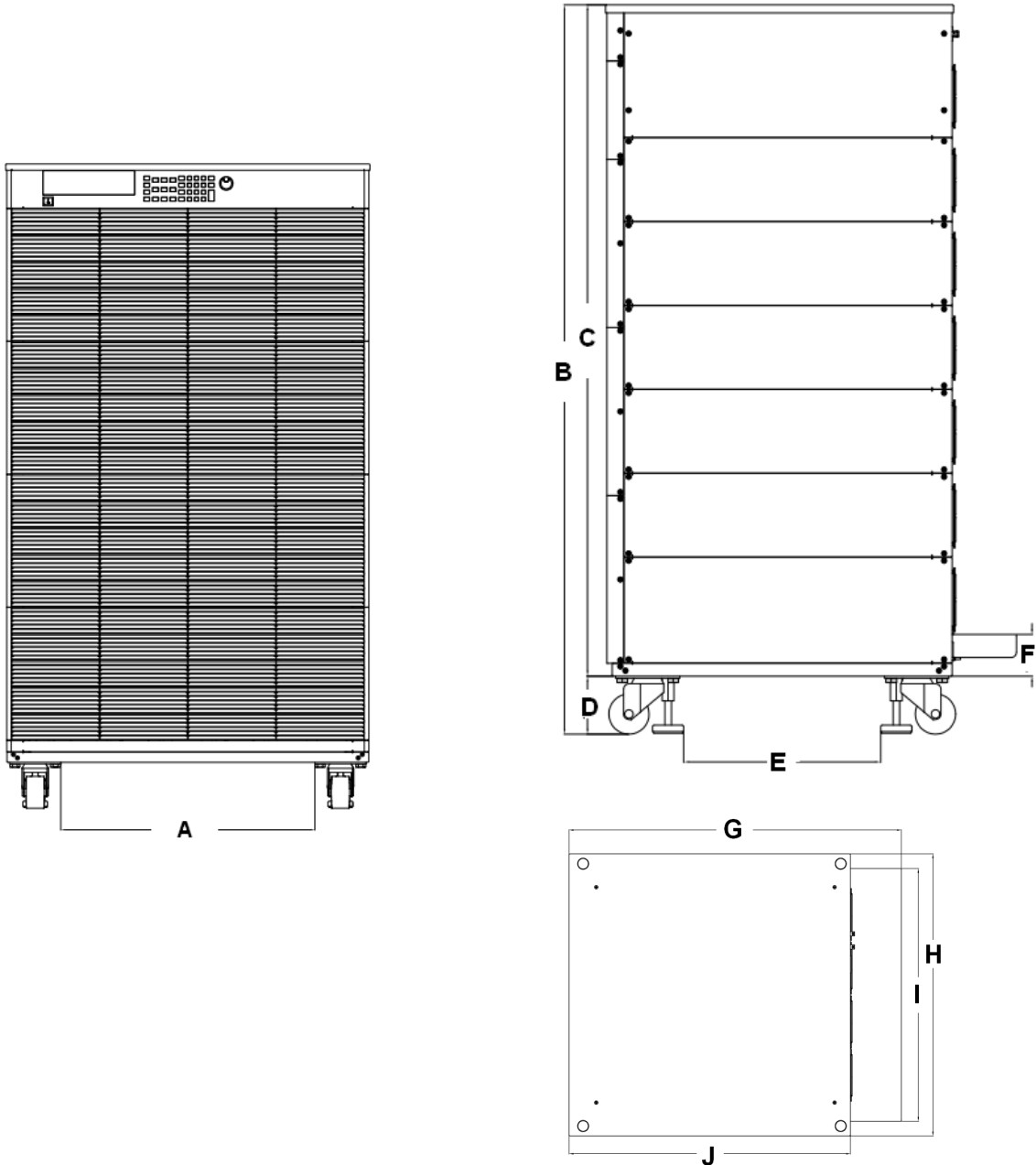

Fig 3-1 36000A Series SIZE description

MODEL	A (mm)	B (mm)	C (mm)	D (mm)	E (mm)	F (mm)
36250A	595	1356.2	1248.2	108	367	77.5
36260A	595	1512.2	1404.2	108	367	77.5
36350A	595	1356.2	1248.2	108	367	77.5
36360A	595	1512.2	1404.2	108	367	77.5
MODEL	G (mm)	H (mm)	I (mm)	J (mm)		
36250A	765.5	853	580	648		
36260A	765.5	853	580	648		
36350A	765.5	853	580	648		
36360A	765.5	853	580	648		

Table 3-1 36000A series Size description

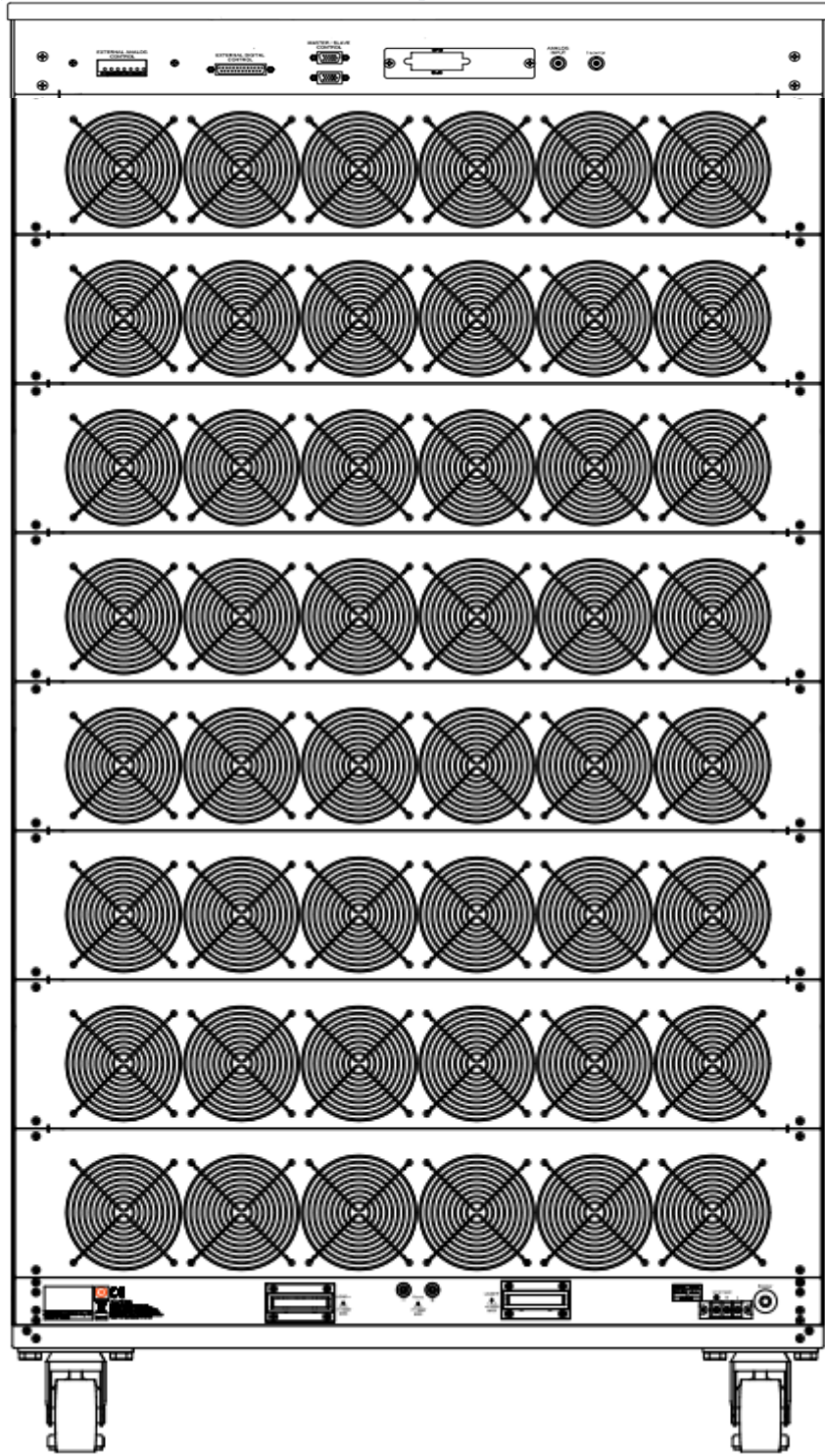

Fig 3-2 36000A Series Rear Panel

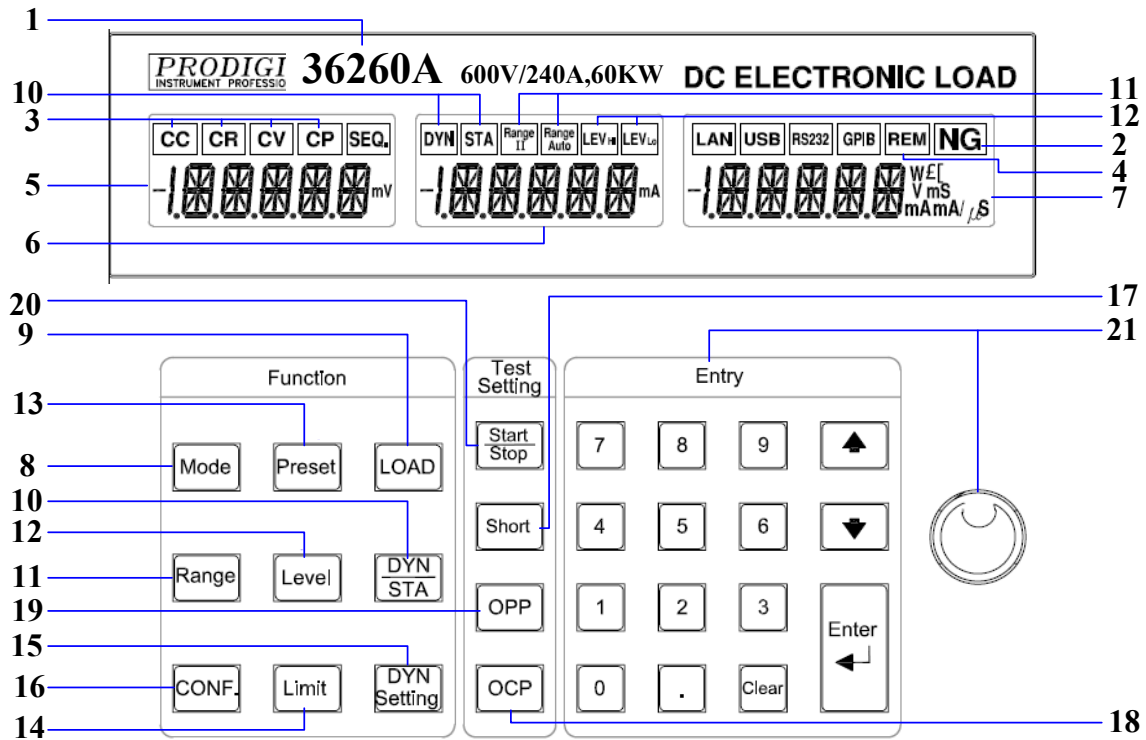

Fig 3-3 36000A Series front Panel

3-2. Instructions

3.2.1. Model number and sink ranges

The model number along with maximum voltage, current and power values are Detailed in this position at the top of the load front panel.

36260A 600V/240A · 60KW DC ELECTRONIC LOAD

It indicates the model number and specifications of 36260A electronic loads.

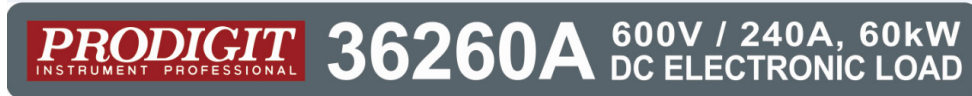

3.2.2. **NG** Indicator

The user can adjust upper and lower limits for voltage, current and power within the CONFIG menu and turn the NG Indicator ON. If a Voltmeter, Ammeter or Wattmeter measurement is outside these set limits then the NG indicator will illuminate.

3.2.3. **MODE** and **CC**, **CR**, **CV**, **CP** mode, LCD Indicator

There are four operating modes that can be selected by pressing the "MODE" key on the 36000A series Electronic Load module.

The sequence is Constant Current (CC), Constant Resistance (CR), Constant Voltage (CV), and Constant Power (CP). Each time the "MODE" key is pressed the operating mode is changed. The actual operating mode selected is indicated on the left hand side of the LCD.

The operating theorem of CC, CR, CV and CP modes are described in Section 1-1. Common application examples for the different operating modes are described in Section 5-3 to 5-6 respectively.

3.2.4. Remote LCD Indicator

If the REMOTE LCD Indicator is illuminated this means that the unit is operating remotely via one of the optional interfaces. While REMOTE is lit it is not possible to make settings manually at the front panel. The LOCAL button on the mainframe can be used to revert back to front panel control. When the unit is operating from the front panel the REMOTE LCD will not be illuminated.

3.2.5. Left 5 digit LCD display

The 5 digit LCD display is a multi-function display. The function of the display changes depending whether the user is in NORMAL mode or in a SHORT, OPP or OCP test modes:

Normal mode:

The left 5 digit display displays the voltage present at the load's input terminals. The value displayed will include the automatic voltage compensation if the sense Terminals are also connected to the device under test (DUT).

Please note that if V-sense is set to AUTO and the sense leads are connected to the DUT the losses need to be approx. 7V (36200A) or 13V (36300A) before the display Compensates for the voltage loss.

If V-sense is set to 'ON' and the sense terminals are connected to the DUT the Load will check and compensate for all voltage drops.

Test Mode:

If the SHORT, OPP or OCP buttons are pressed the left display will show a text Message that correlates with the selected test function.

SHORT test selected: left display will show "Short".

OPP test selected: left display will show "OPP".

OCP test selected: left display will show "OCP".

During the test the left display will show the load Input voltage.

3.2.6. Middle 5 digit LCD display

The middle 5 digit displays also changes function depending if the user is in Normal mode or has entered a setting menu

Normal mode:

In normal mode the middle LCD display functions as a 5 digit ammeter. The 5 digit DAM shows the load current flowing into the DC load when the Load is ON.

Setting Mode:

If CONFIG, LIMIT, DYN, SHORT, OPP or OCP buttons are pressed the middle LCD show a text message according to the setting function it is in. Each subsequent press of the button moves the display to the next available function. The sequence of each setting menu is detailed below

- **CONFIG:** Sequence is "SENSE" → "LDon" → "LDoff" → "POLAR" → "BATT1" → "BATT2" → "BATT3" → "CPRSP".
- **LIMIT:** Sequence is Add.CV → "V_Hi" → "V_Lo" → "I_Hi" → "I_Lo" →

“W_Hi” → “W_Lo” → “NG”.

- **DYN setting:** Sequence is “T-Hi” → “T-Lo” → “RISE” → “FALL”
- **SHORT:** Sequence is “PRESS” → “TIME” → “V_Hi” → “V_Lo”
- **OPP:** Sequence is “PSTAR” → “PSTEP” → “PSTOP” → “Vth”.
- **OCP:** Sequence is “ISTAR” → “ISTEP” → “ISTOP” → “Vth”.

3.2.7. Right 5 digit LCD display

The right 5 digit displays also changes function depending if the unit is in normal Mode or one of the setting menus has been activated.

Normal mode:

In normal mode the right 5 digit displays shows the power consumption in Watts (W).

Setting Mode:

The right display together with the rotary adjustment knob is used to set values. The value changes according to the setting function that is active. The middle LCD Provides a text message to tell the user which part of the setting menu is active.

3.2.7.1. **PRESET** mode. The value of the setting entered on the right display Changes depending on the operating MODE that has been selected

- If CC mode is selected the right display provides setting in amps “A”.
- If CR mode is selected the right display provides setting in ohms “Ω”
- If CV mode is selected the right display provides setting in volts “V”.
- If CP mode is selected the right display provides setting in watts “W”.

3.2.7.2. **LIMIT.** Each press of the LIMIT button changes the middle LCD text. The Sequence and the corresponding setting value shown on the bottom Display is as follows:

- Setting CV+Current limit or CV +Power limit upper limit voltage, the Middle of the display Show “Add.CV”, right display set value, the unit is V.
- V_Hi (left limit voltage) displays the set value in volts “V”
- V_Lo (right limit voltage) displays the set value in volts “V”
- I_Hi (left limit current) displays the set value in amps “A”
- I_Lo (right limit current) displays the set value in amps “A”
- W_Hi (left limit power) displays the set value in watts “A”
- W_Lo (right limit power) displays the set value in watts “A”
- NG displays whether the NG flag is set to “ON” or “OFF”.

3.2.7.3. **DYN** setting. Each press of the DYN setting button changes the text on The middle LCD. The sequence and the corresponding setting value Shown on the bottom display are as follows:

- T-Hi (time high) displays the set value in milliseconds “ms”
- T-Lo (time low) displays the set value in milliseconds “ms”
- Rise (current rise time/slew rate) displays the set value in “A/us” or “A/ms”
- Fall (current fall time/slew rate) displays the set value in “A/us” or “A/ms”

3.2.7.4. **CONFIG.** Each press of the CONFIG button changes the middle LCD Text. The sequence and the corresponding setting value shown on the bottom

Displays are as follows:

- SENSE can be set to 「 AUTO 」 or 「 ON 」
- LDon (load ON voltage) displays the set value in volts “V”
- LDoFF (load OFF voltage) displays the set value in volts “V”
- POLAR (load polarity) can be set to 「 +LOAD 」 or 「 -LOAD 」
- MPPT (Maximum power point tracking)
- BATT1 (Battery Discharge)
- BATT2 (Battery Discharge)
- BATT3 (Battery Discharge)
- CPRSP (CP RESPONSE)

3.2.7.5. SHORT test. This allows the parameters of the short test to be set up. Each press of the SHORT button moves the setting function. The Sequence of the short test along with the setting value is as follows:

- Short Press Start (pressing the red START/STOP button starts the test)
- TIME shows the duration of the SHORT test. “CONTI”, on the bottom display indicates continuous. Time can be adjusted in “ms”.
- V-Hi (voltage high threshold) displays the set value in volts “V”
- V-Lo (voltage low threshold) displays the set value in volts “V”

When the test is started the right display will show RUN. When the test Has finished the right display will show END.

3.2.7.6. OPP test. This allows the parameters of the over power protection test to Be Set up. Each press of the OPP button moves the setting function. The Sequence of the OPP test along with the setting value is as follows:

- OPP Press Start (pressing the red START/STOP button starts the test)
- PSTAR (power start point) right display provides setting in watts “W”
- PSTEP (power steps) right display provides setting in watts “W”
- PSTOP (power stop point) right display provides setting in watts “W”
- VTH (voltage threshold) right display provides setting in volts “V”

When the test is started the right display will show the power value Being taken by the load. If the Device Under Test is able to supply the Load according to the values set then the middle display will show PASS And the right display will show the maximum power taken during the OPP test. If, during the test, OTP is displayed the over temperature Protection has been engaged. Similarly if OPP is shown on the display The over power protection has been activated.

3.2.7.7. OCP test. This allows the parameters of the over current protection test To be set up. Each press of the OCP button moves the setting function. The sequence of the OCP test along with the setting value is as follows:

- OCP Press Start (pressing the red START/STOP button starts the test)
- ISTAR (current start point) right display provides setting in amps “A”
- ISTEP (current steps) right display provides setting in amps “A”
- ISTOP (current stop point) right display provides setting in amps “A”
- VTH (voltage threshold) right display provides setting in volts “V”

When the test is started the right display will show the current value being

Taken by the load. If the Device under Test is able to supply the load According to the values set then the middle display will show PASS and The Right display will show the maximum current taken during the OCP Test. If, during the test, OTP is displayed the over temperature protection Has been Engaged. Similarly if OPP is shown on the display the over Power protection has been activated.

3.2.8. **MODE** and CC, CR, CV, CP Indicator

There are four operating modes. These can be selected in turn by pressing the "MODE" key on the 36000A series Electronic Load module. The sequence is:

- (CC) Constant Current
- (CR) Constant Resistance
- (CV) Constant Voltage
- (CP) Constant Power

The appropriate LCD will illuminate according to the operating mode is selected.

3.2.9. **LOAD** Key and LED

The input to the 36000A series Electronic Load can be switched ON/OFF by using The "LOAD" button. Indication of the ON/OFF state is provided by illumination of the Button.

LOAD button lit	= LOAD ON	(load sinks according to the preset values)
LOAD button unlit	= LOAD OFF	(the load does not sink current)

Turning the LOAD OFF does not affect the preset values. When the LOAD ON state is enabled the unit will revert to sinking according to the preset values.

3.2.9.1. When the Load ON/OFF key is operated the current taken by load will follow The RISE or FALL with time according to the preset rate. The current RISE And FALL times can be adjusted in the DYN Setting button of the front panel.

3.2.9.2. In addition to the LOAD ON/OFF function the user can also adjust the Voltage level at which the unit will automatically start or stop sinking energy. The adjustable LDon and LDoff voltage levels are found within the CONFIG Menu. Please note that the LDoff level cannot be set higher than the LDon Level.

Please refer to table 1-4 for adjustment ranges.

3.2.10. **DYN** /STA key and LED

The DYN button allows the user to switch between DYNAMIC operation and STATIC operation. Dynamic operation is only possible in constant current (CC) or Constant power (CP) mode only. The LED next to the DYN button will become lit When DYNAMIC operation is selected. If you are in constant resistance (CR) or Constant voltage (CV) mode pressing the DYN button will have no effect.

3.2.11. **Range** Key and LED

The 36000A series Load Module features 2 setting ranges for CC, CR, CV & CP Operation. This allows improved resolution for setting low values. When left in the Default AUTO mode the changeover between ranges is automatic depending on The setting value entered.

If desired the RANGE button can be pressed to force the unit to operate only in RANGE II. This is signaled by the accompanying LED becoming lit. Please note That it is only possible to force RANGE II in CC mode.

3.2.12. **LEVEL** Key and LED

The LEVEL button is used to program a High or Low load value. The setting value Changes between current, resistance, voltage or power depending whether CC, CR, CV or CP mode has been selected. If the LED is lit then the High level value setting Has been enabled. If the LED is not lit then the low load level can be set using the Rotary switch in combination with the arrow keys.

In STATIC mode the user can switch between High and low load levels during Operation.

In DYNAMIC operation (CC & CP modes only) the preset high and low levels are Used to define the dynamic waveform.

Please note that the low level setting cannot exceed the high level. The converse is Also true in that the High level cannot be set below the low level.

3.2.13. **Preset** Key and LED

If the PRESET key is pressed the button will become lit indicating that the PRESET mode has been accessed. The lowest 5 digit display will change from showing the power consumption in watts to displaying the value to be preset. The value that can be programmed changes according to the operating mode that has been selected.

3.2.13.1. Constant Current (CC) mode:

The High and Low levels of load current can be preset at right 5 digit LCD. The "A" LED will be lit indicating the setting value is amps.

3.2.13.2. Constant Resistance (CR) mode:

The High and Low levels of load resistance can be preset on the right 5 Digit LCD. The "Ω" LED will be lit indicating the setting value is ohms.

3.2.13.3. Constant Voltage (CV) mode:

The High and Low levels of load voltage can be preset on the right 5 Digit LCD. The "V" LED will be lit indicating the setting value is volts.

3.2.13.4. Constant Power (CP) mode:

The High and Low levels of load power can be preset on the right 5 digit LCD. The "W" LED will be lit indicating the setting value is watts.

3.2.13.5. Dynamic mode (CC, CR or CP modes only):

Each press of the DYN button cycles through the dynamic load settings. The DYN settings are used in conjunction with the High and Low levels Of load current to define the dynamic waveform. Each press of the DYN

Button switches from T_Hi (time high), to T_Lo (time low), to Rise time And then to fall time. The middle LCD shows the section of the dynamic Waveform which is programmed with the rotary knob and read from the Right display. The “ms” LED shows that the settings are programmed in Milliseconds.

3.2.14. **Limit** key

The LIMIT button allows the user to set left and right thresholds for voltage, current Or power. These threshold settings are used in conjunction with the NG function to flag when the load is operating outside the desired limits

Each press of the LIMIT key enables a different value to be entered. On first press Of the LIMIT key the button will illuminate and V-Hi will be displayed on the middle LCD. The setting is made with the rotary knob and can be read from the right LCD during setting. The setting sequence is shown below:

- Add.CV (CV+Current limit or CV +Power limit upper limit) →
- V_Hi (DVM upper limit) →
- V_Lo (DVM lower limit) →
- I_Hi (DAM upper limit) →
- I_Lo (DAM lower limit) →
- W_Hi (DWM upper limit) →
- W_Lo (DWM lower limit) →
- NG OFF/ON (No Good Flag) →
- LIMIT setting function OFF

The engineering unit is “V”, “A” or “W” depending on the threshold LIMIT being set.

- Setting CV+Current limit or CV +Power limit upper limit voltage, Middle 5 digit LCD display” Add.CV” ,right 5 digit LCD display the unit is "V" ,The Add.CV set range from 0.00 V to 600.00V step 0.01V by rotating the Setting knob.

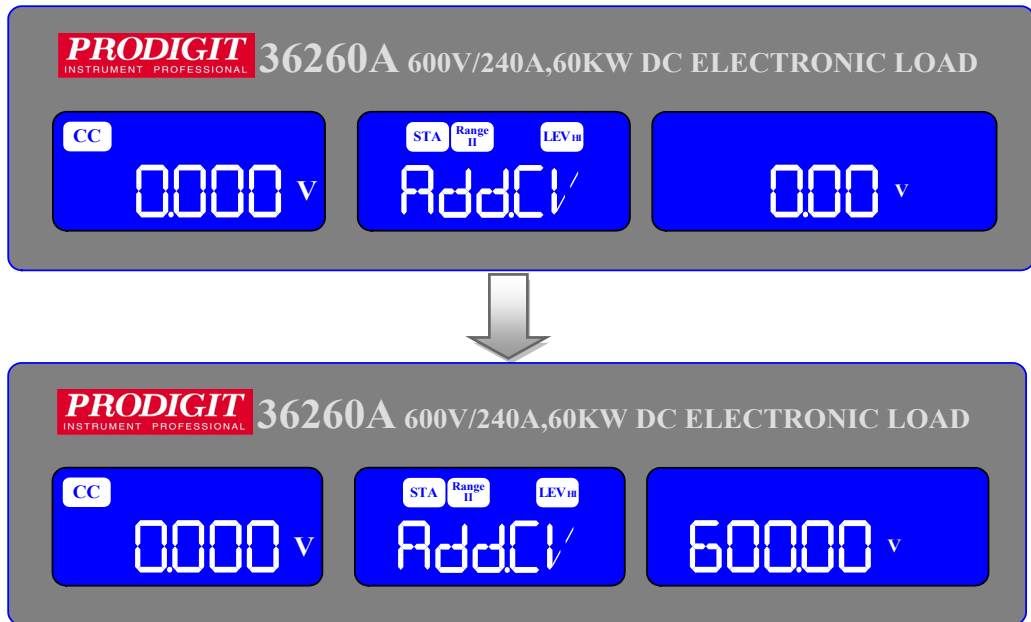

- Setting upper limit voltage VH , Middle 5 digit LCD display "V-Hi" ,right 5 digit LCD display the unit is "V" ,The V-Hi set range from 0.00 V to 600.00V step 0.01V by rotating the Setting knob.

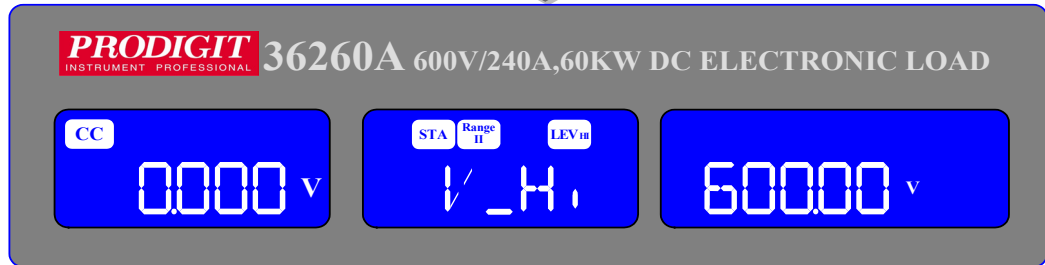
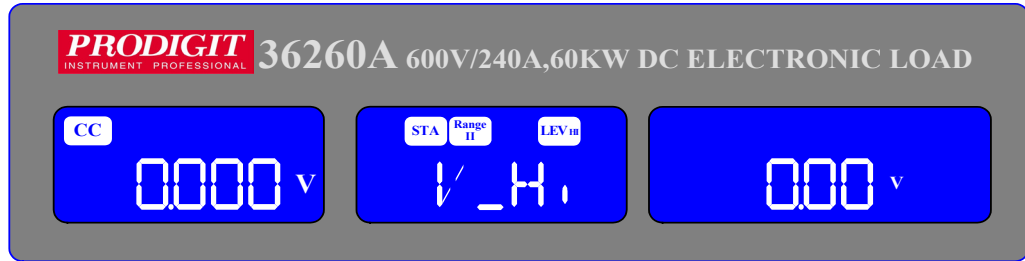

- Setting lower limit voltage VL, Middle 5 digit LCD display "V-Lo" ,right 5 digit LCD display the unit is "V" ,The V-Lo set range from 0.00 V to 600.00V step 0.01V by rotating the Setting knob.

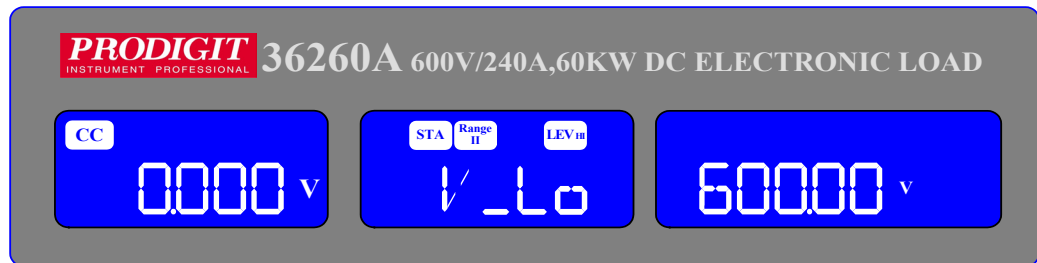
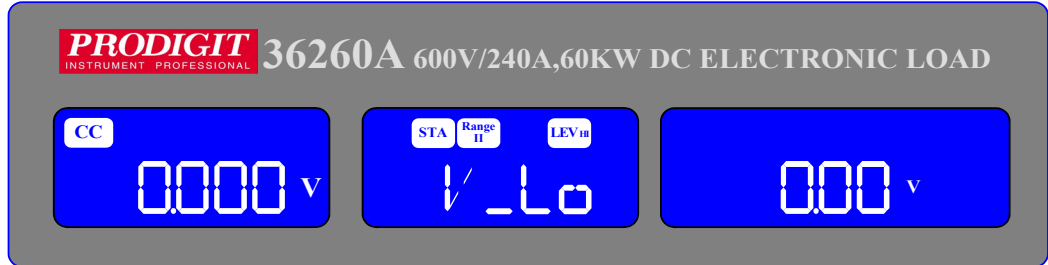

- Setting Upper limit current IH , Middle 5 digit LCD display "I-Hi" ,right 5 digit LCD display the unit is "A", The I-Hi set range from 0.000 A to 240.00A step 0.0001A by rotating the Setting knob.

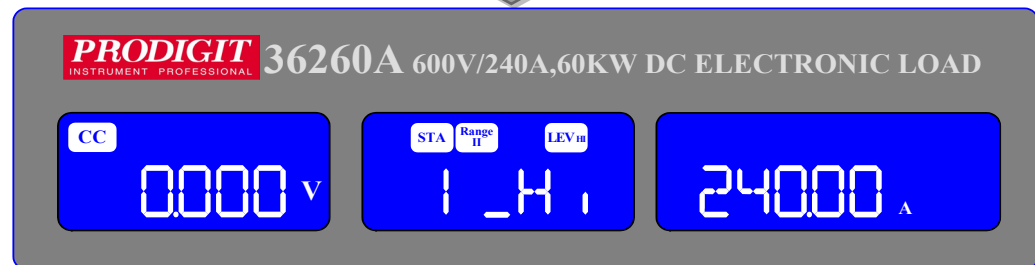
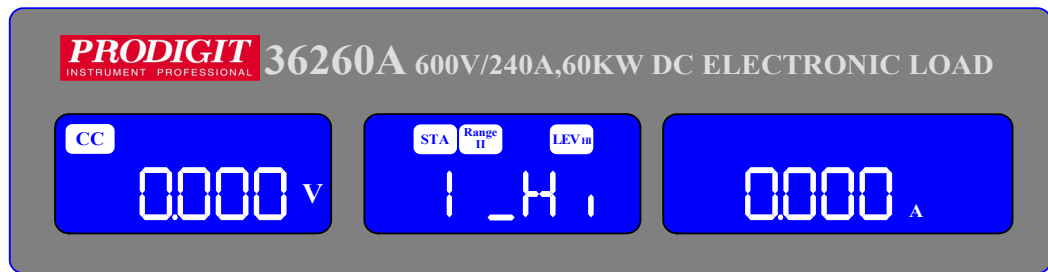

- Setting lower limit current IL , Middle 5 digit LCD display "I-Lo" ,right 5 digit LCD display the unit is "A" ,The I-Lo set range from 0.000 A to 240.00A step 0.001A by rotating the Setting knob.

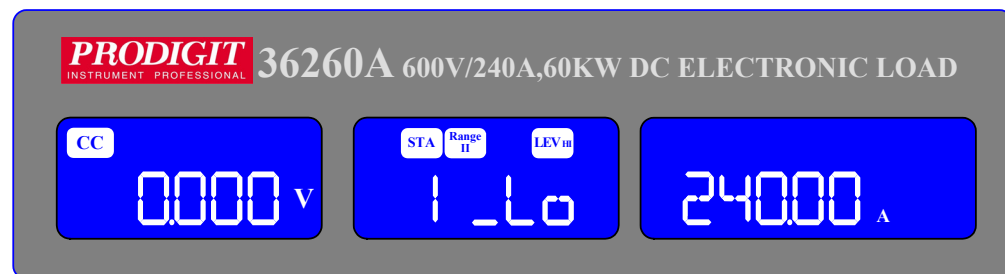
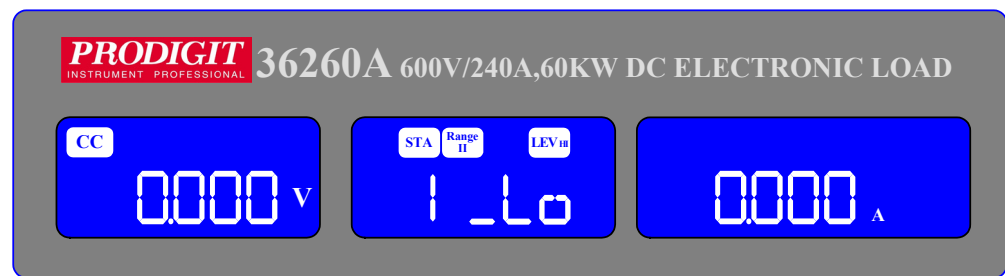

- Setting Upper limit power WH, Middle 5 digit LCD display "W-Hi" right 5 digit LCD display the unit is "W", The W-Hi set range from 0 W to 60000W step 1W by rotating the Setting knob.

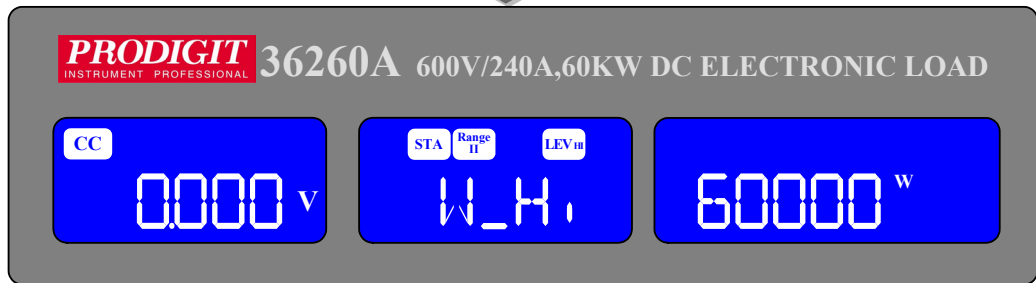
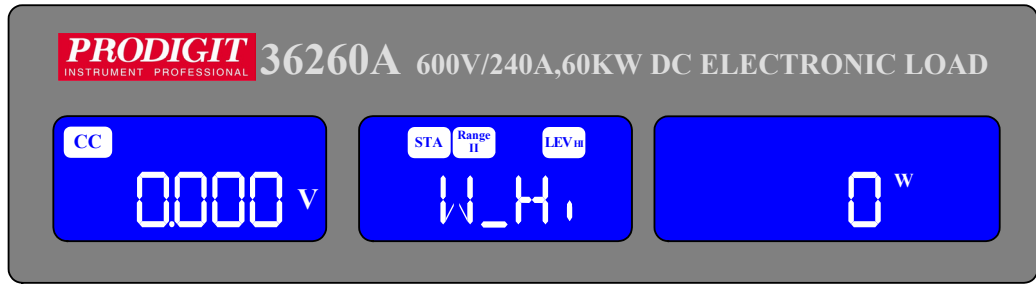

- Setting lower limit power WL, Middle 5 digit LCD display "W-Lo" right 5 digit LCD display the unit is "W", The W-Lo set range from 0 W to 60000W step 1W by rotating the Setting knob.

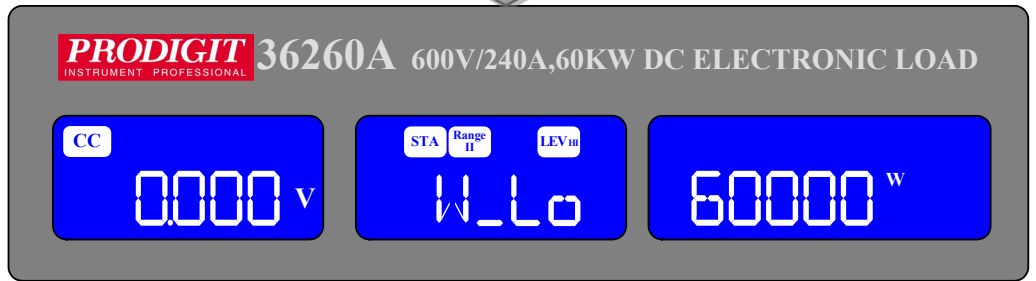
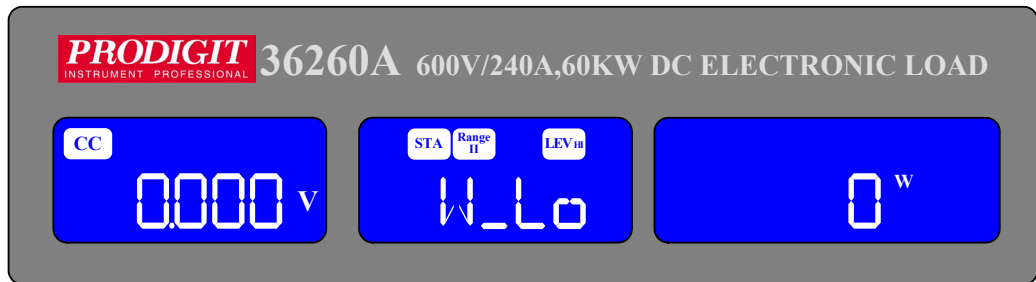

- Setting NG ON/OFF, When exceed VH、VL、IH、IL、WH、WL One of these Whether NG on LCD display.

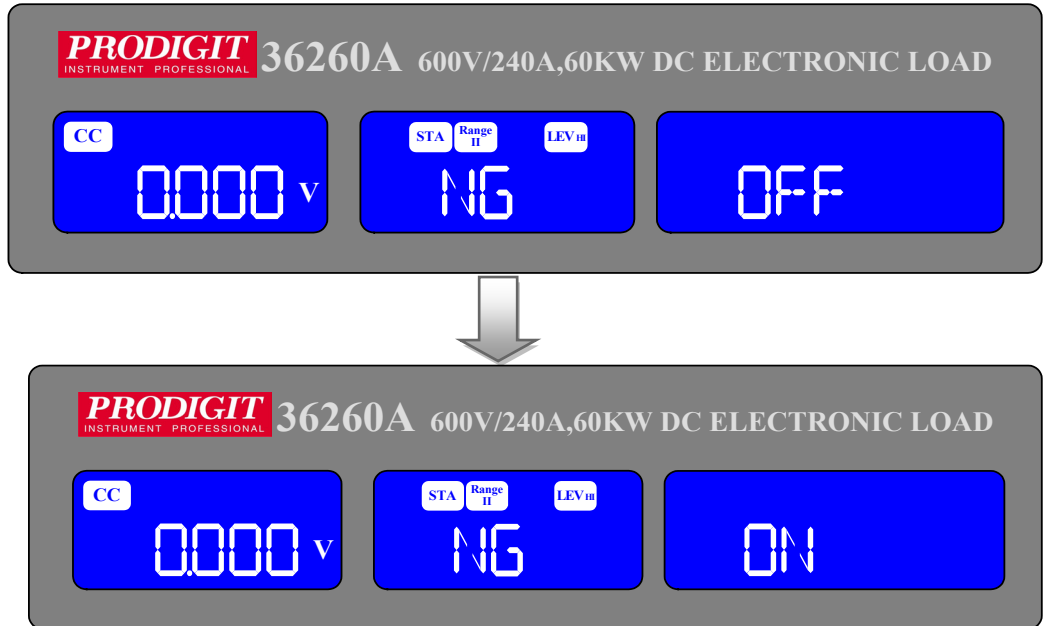

- CC mode, press limits key to set the V-Hi and V-Lo voltage upper and lower limits of the GO / NG.

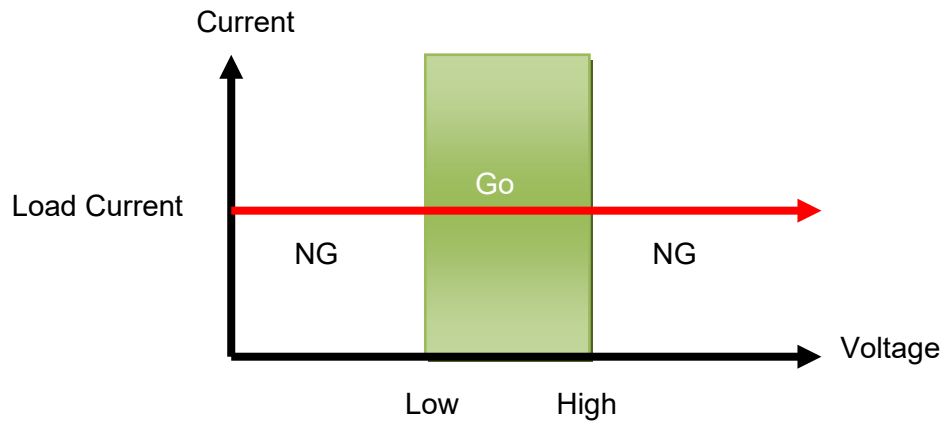

- CC Dynamic Mode, press key to set the Level Hi and Level Low voltage upper and lower limits of the GO / NG.

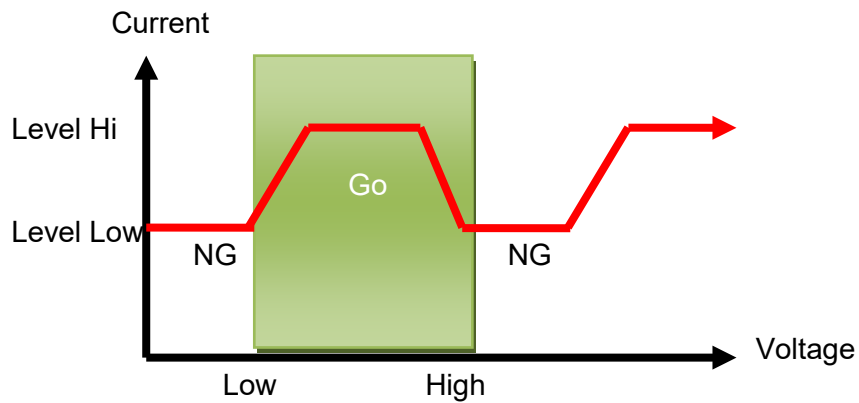

- CR mode, press limits key to set the V-Hi and V-Lo voltage upper and lower limits of the GO / NG.

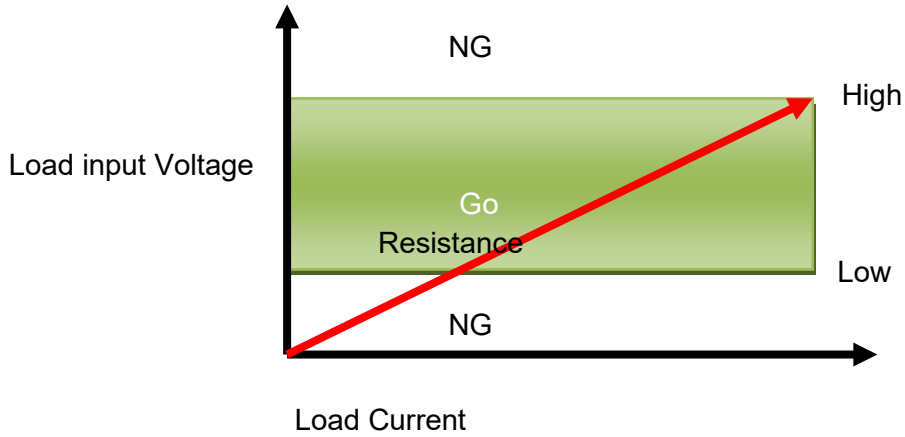

- CV mode, press limits key to set the I-Hi and I-Lo Current upper and lower limits of the GO / NG.

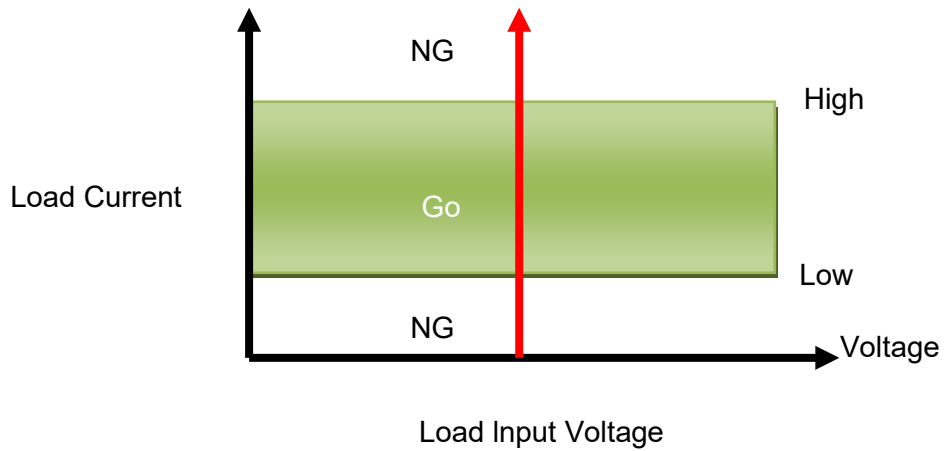

- CP mode, press limits key to set the W-Hi and W-Lo power upper and lower limits of the GO / NG.

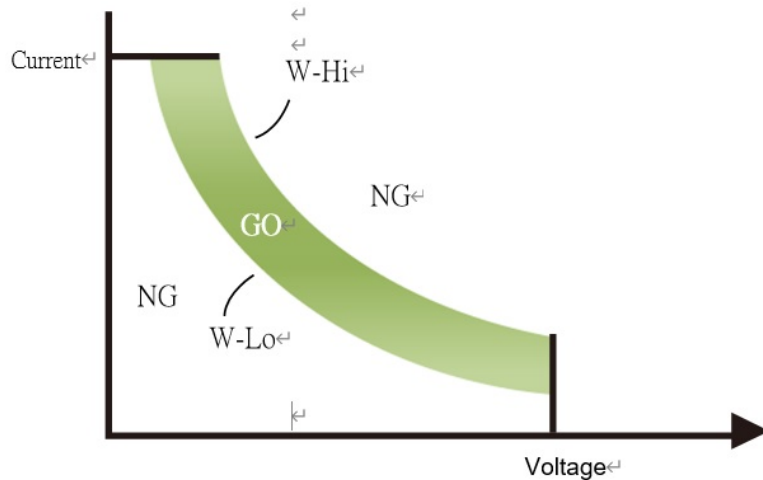

DYN
setting

3.2.15. Key

The DYN button allows the user to define the timings of the dynamic load Waveform. Firstly the high and low levels of load current will need to be set via the LEVEL switch. The RISE and FALL times between the low load current and the high load current along with the TIME the waveform is HIGH and the TIME LOW Can be set via the DYN menu.

Each press of the DYN key enables a section of the DYNAMIC waveform to be set. On first press of the DYN key the button will illuminate and T-Hi will be displayed On the middle LCD. The value is adjusted with the rotary knob and can be read From the right LCD during setting. The setting sequence is shown below:

T_Hi (time the waveform is high) →
 T_Lo (time the waveform is low) →
 RISE (rise time) →
 FALL (fall time) →
 DYN setting function OFF

The time that the waveform is high includes the rise time and is set in “ms”
 The time that the waveform is low includes the fall time and is set in “ms”
 The RISE and FALL time is set in “A/μs”. The actual engineering unit is shown on
 The right of the Right 5 digit display

- Press DYN setting key, LED will ON
 Setting level High Period, Middle 5 digit LCD display will show “T-Hi”
 Right 5 digit LCD display will show setting value, the unit is “ms”, The T-Hi
 Set range from 0.010 ms to 9999 ms step 0.001ms by rotating the setting
 Knob.

There are four ranges from 0.050 ms to 9999 ms, the ranges are below:

- Range 1:0.010ms~9.999ms
- Range 2:10.00ms~99.99ms
- Range 3:100.0ms~999.9ms
- Range 4:1000ms~9999ms

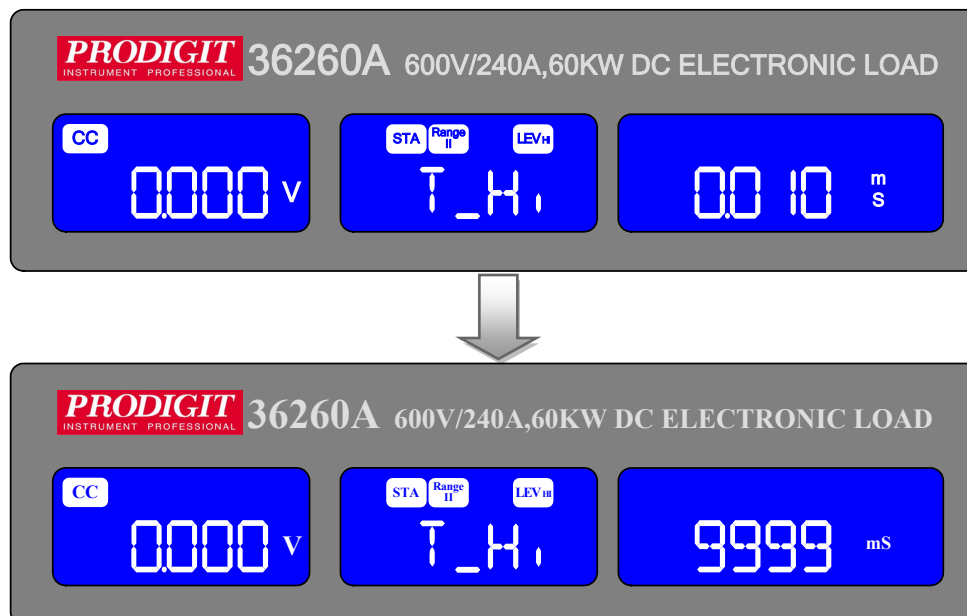

- Setting level Low period, Middle 5 digit LCD display will show “T-Lo”, Right 5 digit LCD display will show setting value, the unit is “ms” , The T-Lo set range from 0.010 ms to 9999 ms step 0.001ms by rotating the Setting knob.

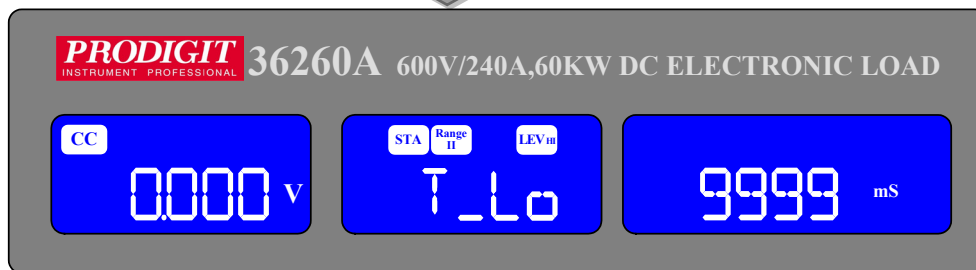
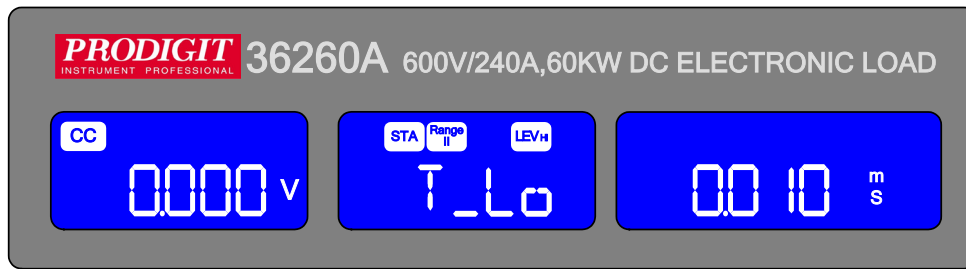

- Setting rise time, Middle 5 digit LCD display will show “RISE”, Right 5 digit LCD display will show setting value, the unit is “A/μs” , The RISE time set range from 0.192A/us to 12 A/us step 48mA/us by rotating the Setting knob.

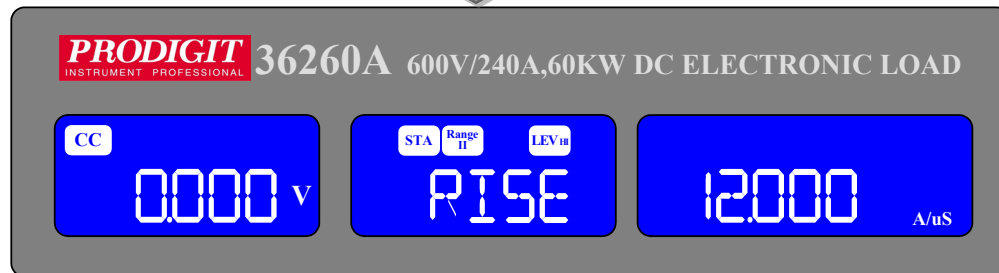
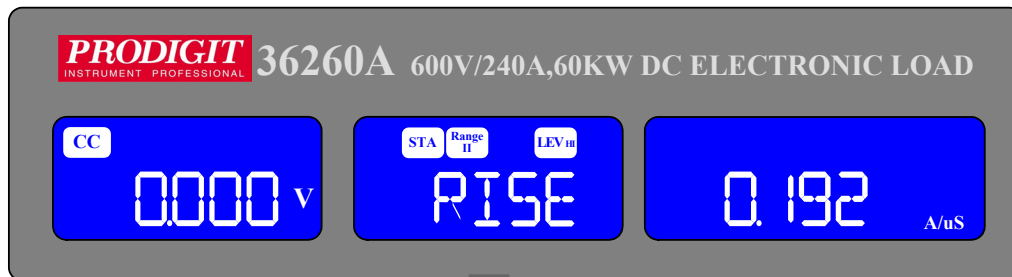

- Setting fall time, Middle 5 digit LCD display will show “FALL”, Right 5 digit LCD display will show setting value, the unit is “A/μs”, The FALL time set range from 0.192A/us to 12A/us step 48mA/us by rotating the Setting knob.

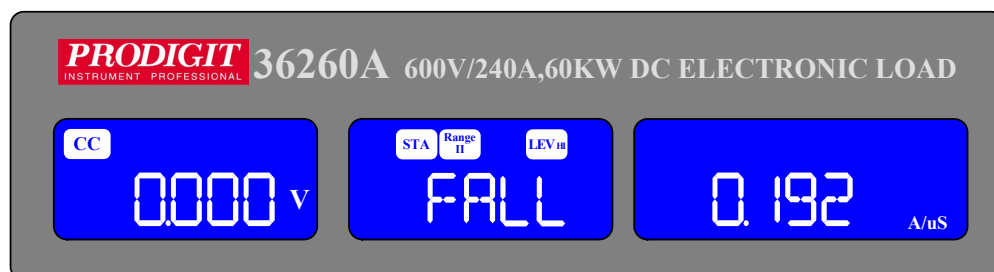

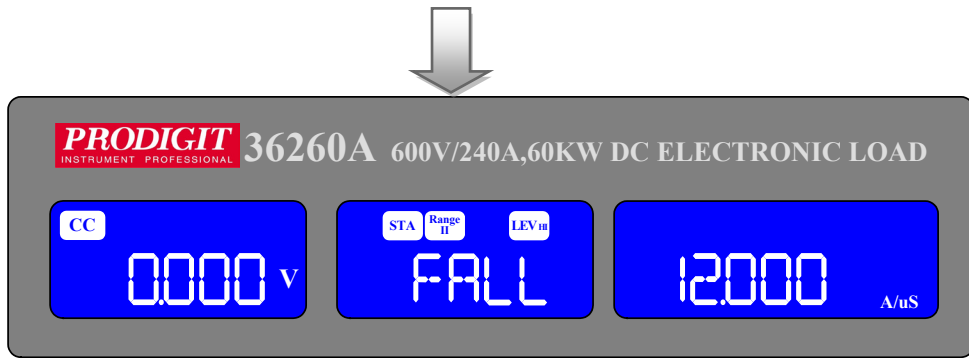

3.2.16. **Config** key

The CONFIG key allows the sense function to engage automatically or switched ON. The CONFIG key also enables the LOAD to automatically turn ON/OFF When a voltage level is reached. The polarity symbol can also be switched via the CONFIG menu.

Each press of the CONFIG key moves the menu on one step. On first press of the CONFIG key the button will illuminate and SENSE will be displayed on the middle LCD. The value is adjusted with the rotary knob and can be read from the right LCD during setting. The setting sequence is shown below:

- SENSE (AUTO or ON) →
- LDon (Voltage at which LOAD turns ON) →
- LDoff (Voltage at which LOAD turns OFF) →
- POLAR (change polarity symbol) →
- MPPT →
- BATT1 →
- BATT2 →
- BATT3 →
- CPRSP →
- Exit CONFIG options

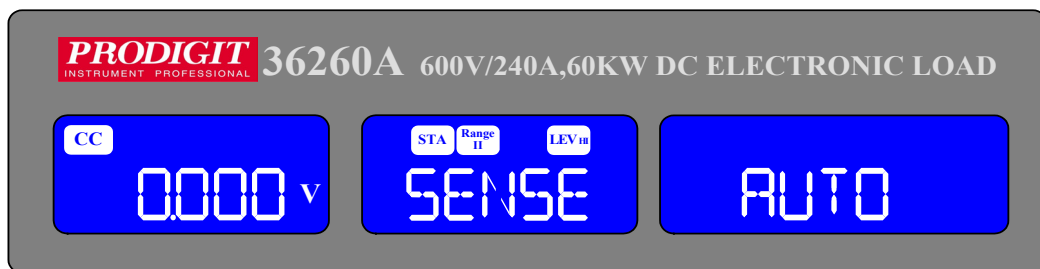

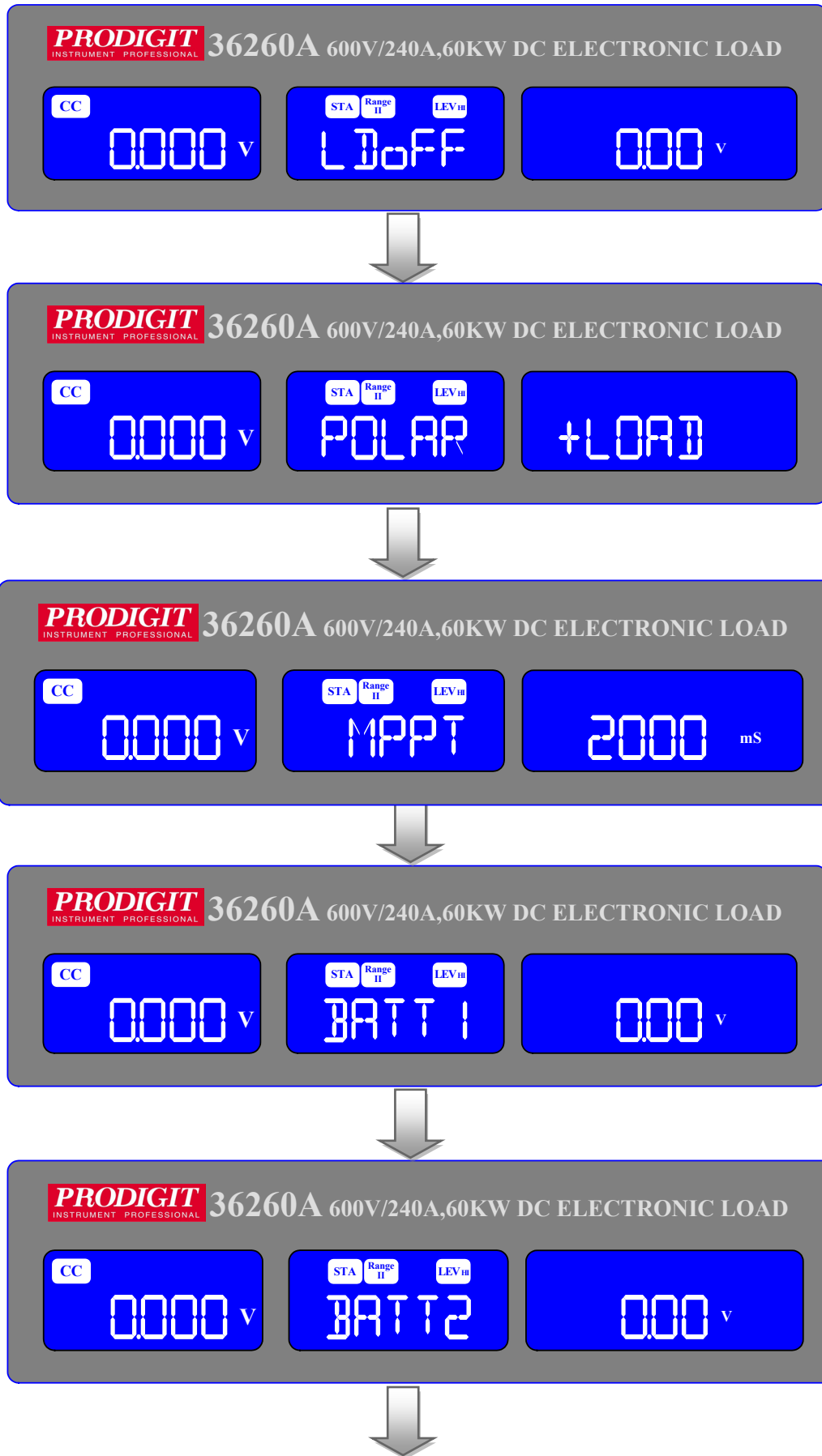

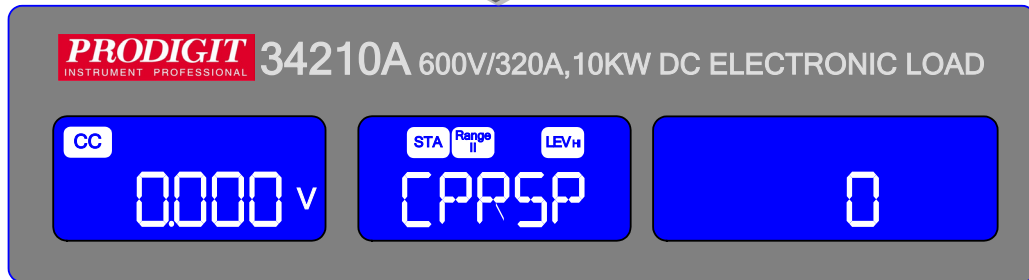
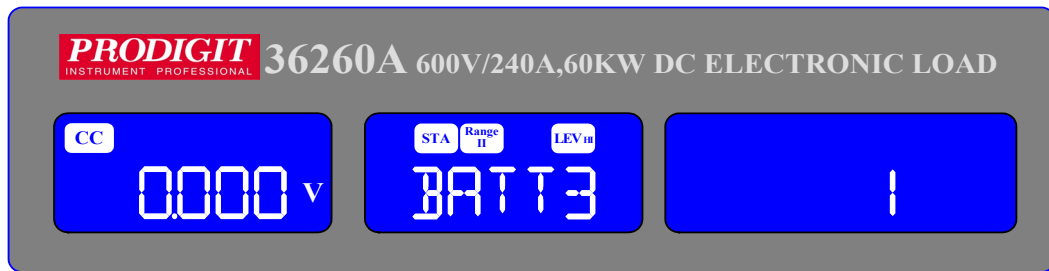

Note 1: The adjustable LDon (LOAD ON) voltage is valid for CC, CR & CP operating Modes. The adjusted LDon voltage will not operate in CV mode.

Note 2: The LDon (LOAD ON) voltage setting cannot be lower than the LDOff (LOAD OFF) voltage. If 0V is required for both LOAD ON and LOAD OFF make the LOAD OFF adjustment first.

- Setting Vsense and load input switching methods, the middle of the 5 digit LCD display will show "SENSE", Right 5 digit LCD display will show "AUTO" or "ON".

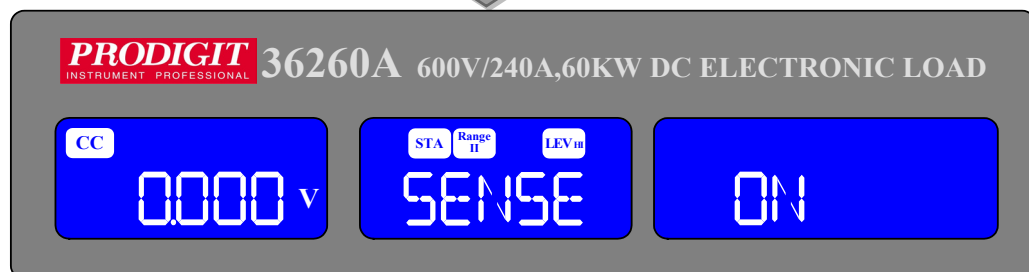
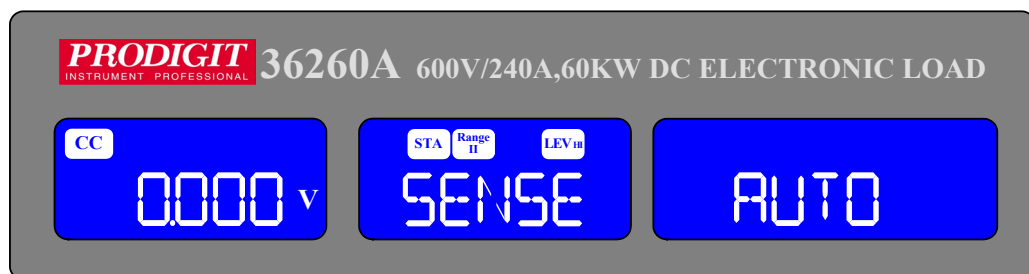

- Set Load ON voltage, the middle of the 5 digit LCD display will show "LDon ", Right 5 digit LCD display will show setting value, the units is V, The Load ON Voltage set range from 0.0V to 100.0V step 0.4V by rotating the setting knob. If the load is greater than the input voltage Load ON voltage setting, the Electronic load current begin to load on.

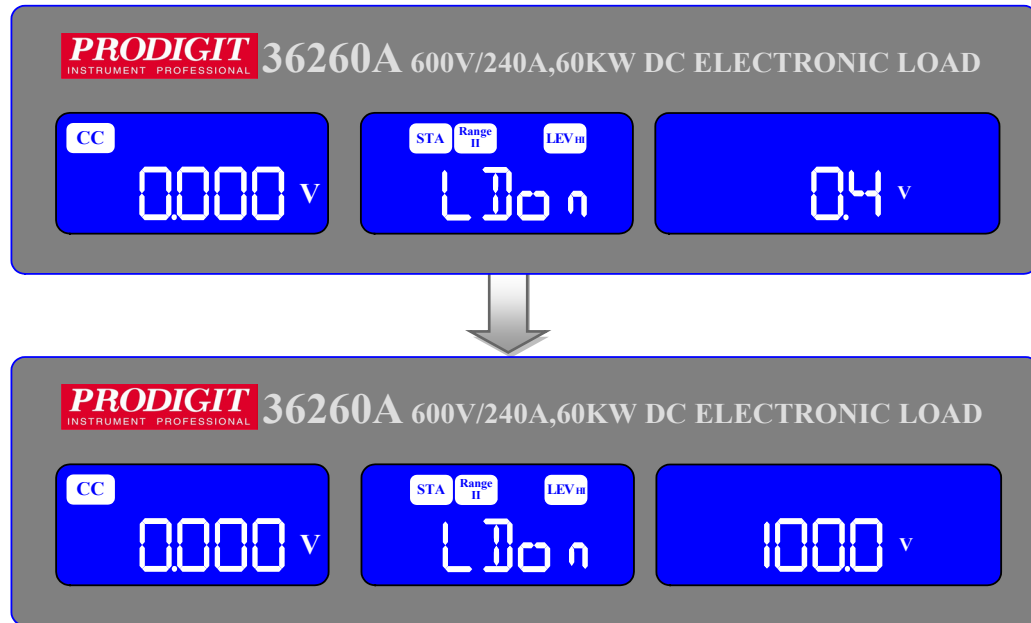

NOTE1: CC/CR/CP MODE is controlled by Load ON voltage, CV MODE is not Controlled by Load ON voltage.

- Setting Load OFF voltage, the middle of the 5 digit LCD display will show "LDoFF", Right the 5 digit LCD display will show settings value, the units is V, The Load OFF Voltage set range from 0.0V to 99.00V step 0.01V by rotating The Setting knob.

If the load input voltage is less than Load OFF setting voltage, the electronic Load to load off.

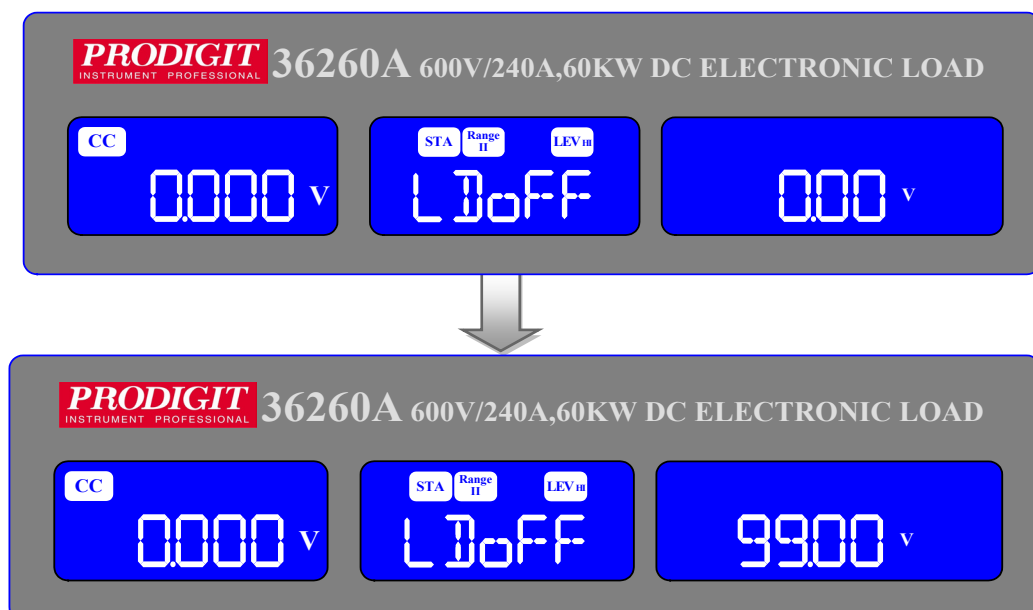

- Set Load polarity, the middle of the 5 digit LCD display will show "POLAR", Right the 5 digit LCD display "will show + LOAD" or "-LOAD", use the knobs and key Settings "+ LOAD" or "-LOAD".

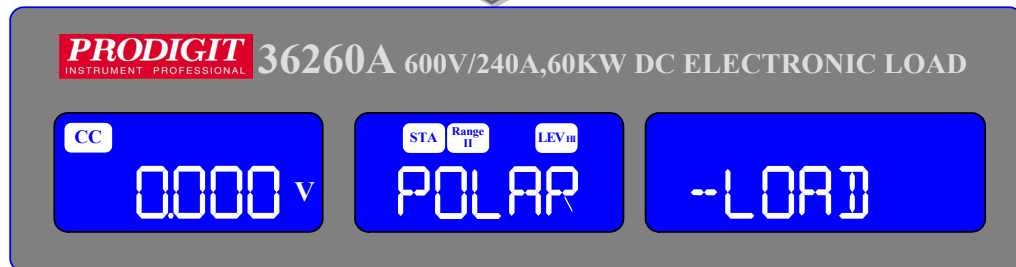
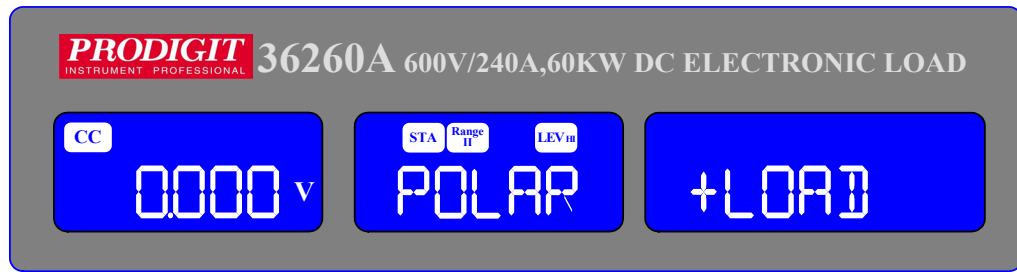

- Setting MPPT (Maximum power point tracking) testing, the middle of the 5 digit LCD display will show "MPPT", Right the 5 digit LCD display "1000", the MPPT setting range from 1000mS to 60000mS.

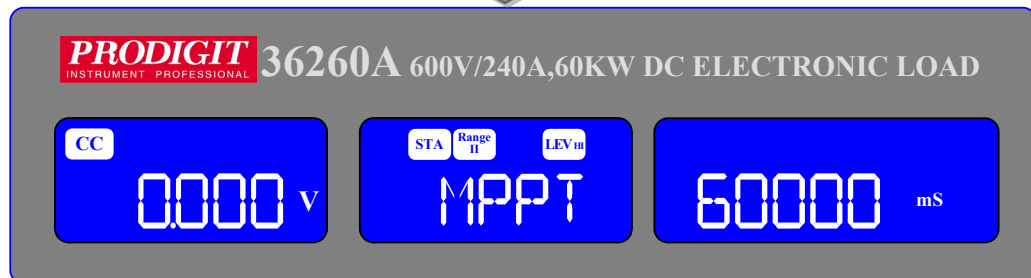
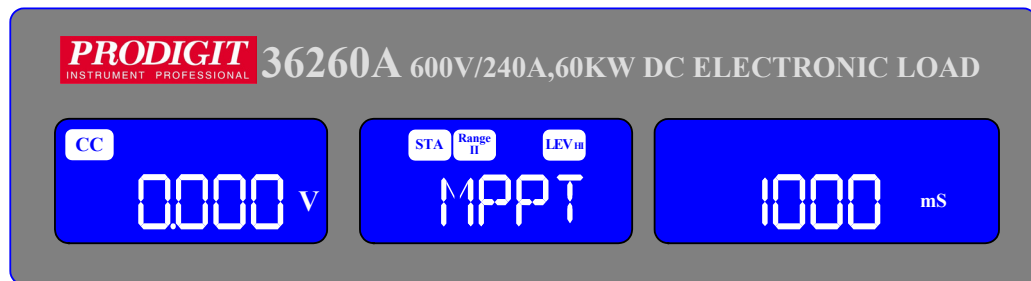

Remote Operation with remote command:

1. Power ON 36000A series Load
 2. Connecting UUT (PV panel) to load input terminal
 3. Sent MPPTIME interval time (MPPTIME{sp} NR2, MPPTIME 1000, the range is 1000 to 60000 mS), the record data is no limitation in 36000A series internal memory.
 4. Sent command MPPT ON to start tracking MPP of UUT
 5. Sent MPP? command to read back the voltage, current and power (MPP)
 6. Sent MPPT OFF to stop tracking the MPP of UUT
- Setting BATT1 , the middle of the 5 digit LCD display will show "BATT1", Right the 5 digit LCD display will show settings value, the units is V, The BATT1 set Range from 0.00V to 600.00V step 0.01V by rotating the setting knob.

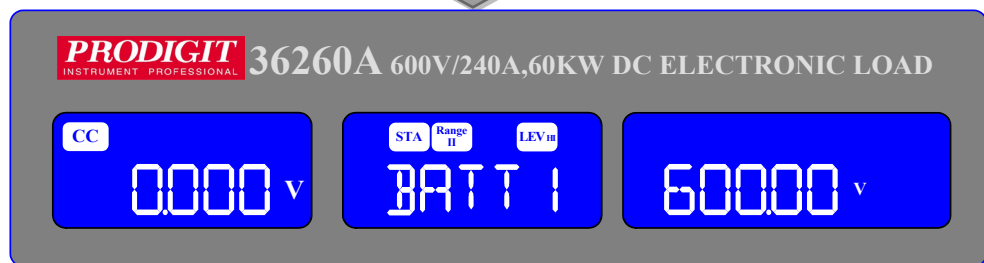
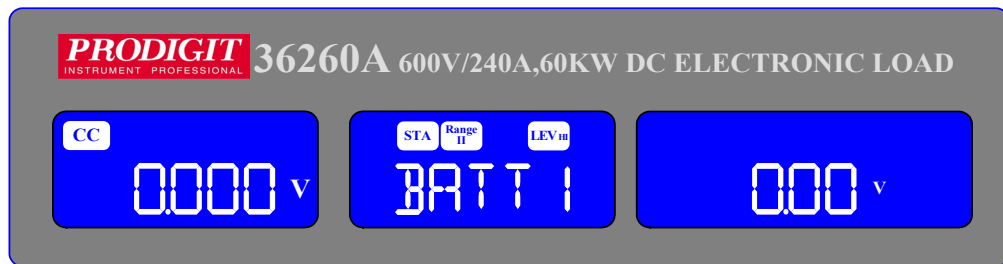

- Setting BATT2 , the middle of the 5 digit LCD display will show "BATT2", Right the 5 digit LCD display will show settings value, the units is V, The BATT2 set range from 0.00V to 600.00V step 0.01V by rotating the setting knob.

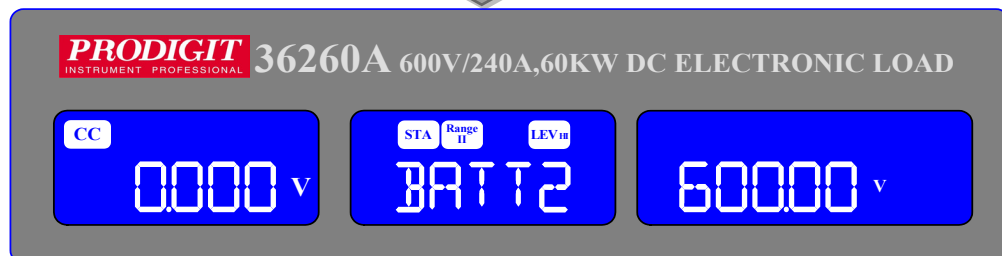
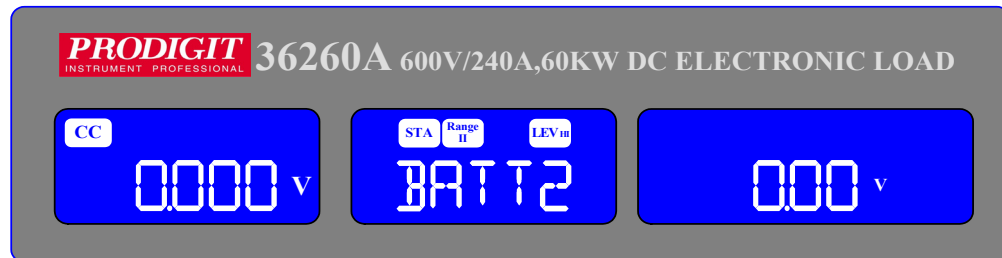

- Setting BATT3 , the middle of the 5 digit LCD display will show "BATT3", Right The 5 digit LCD display will show settings value, the units is sec, The BATT3 set Range from 1 to 9999 step 1 by rotating the Setting knob.

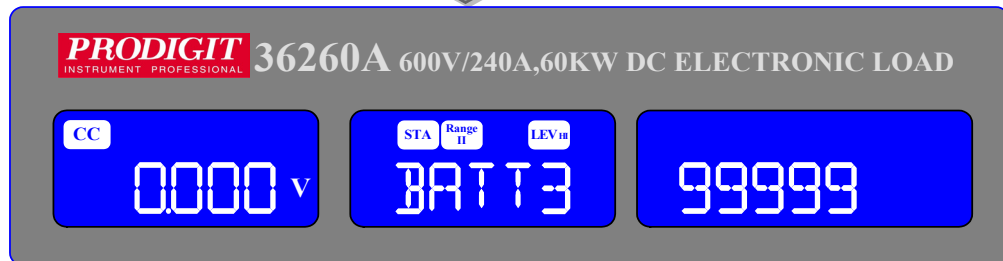
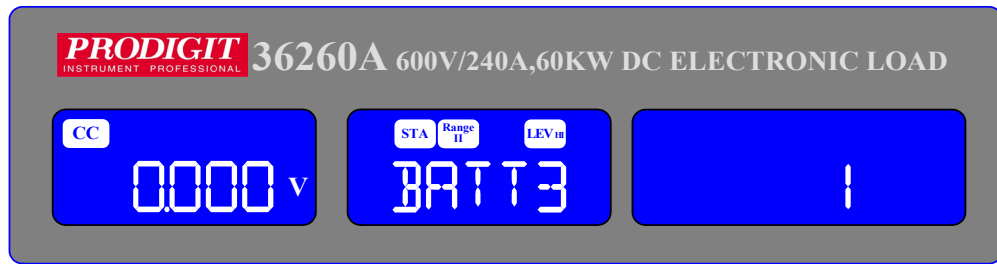

- Set CPRSP. The middle 5-digit display shows "CPRSP". The 5-digit display on the right displays "0". Use the knob and key to set the range from 0 to 4.

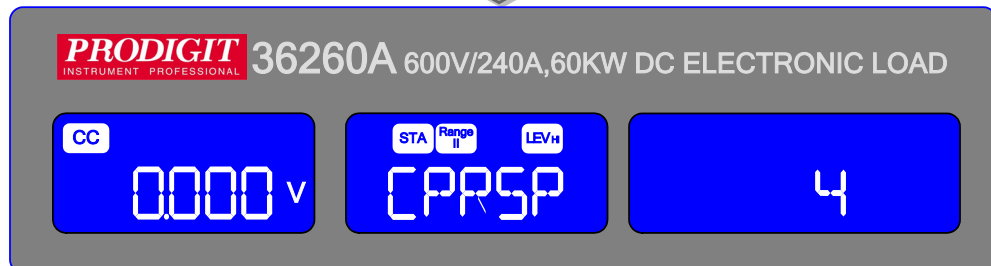
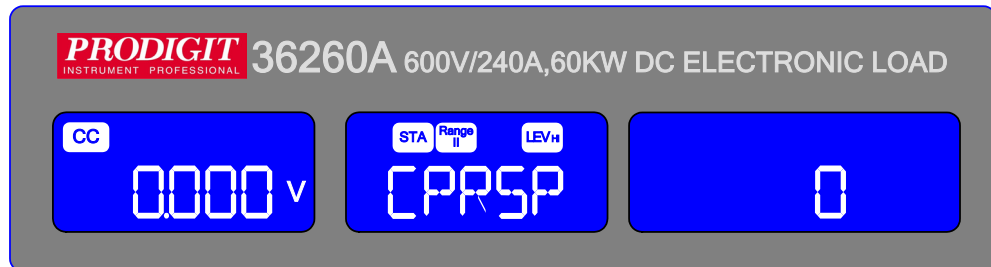

3.2.17. **Short** key

The SHORT key allows the parameters of a SHORT circuit test to be entered. The SHORT test will attempt to sink high current up to the 36000A series load Maximum current in order to check the power source's protection and behavior. The test time can be adjusted and threshold values for the High and low voltage limits set.

Pressing the SHORT key once will cause the button to illuminate. The Message "SHORT PRESS START" will be shown across the 3 displays.

Each press of the SHORT key moves the menu on one step. The left and Middle LCDs show the currently selected test parameter as text. The value is adjusted by the rotary knob and can be read from the right display during Setting.

The setting sequence is shown below:

SHORT PRESS START (pressing the red start/stop key starts test) →
 SHORT TIME (CONTI = Continuous or 100ms to 10,000ms possible) →
 SHORT V_Hi (High voltage threshold setting) →
 SHORT V_Lo (Low voltage threshold setting) →
 Exit SHORT test set-up

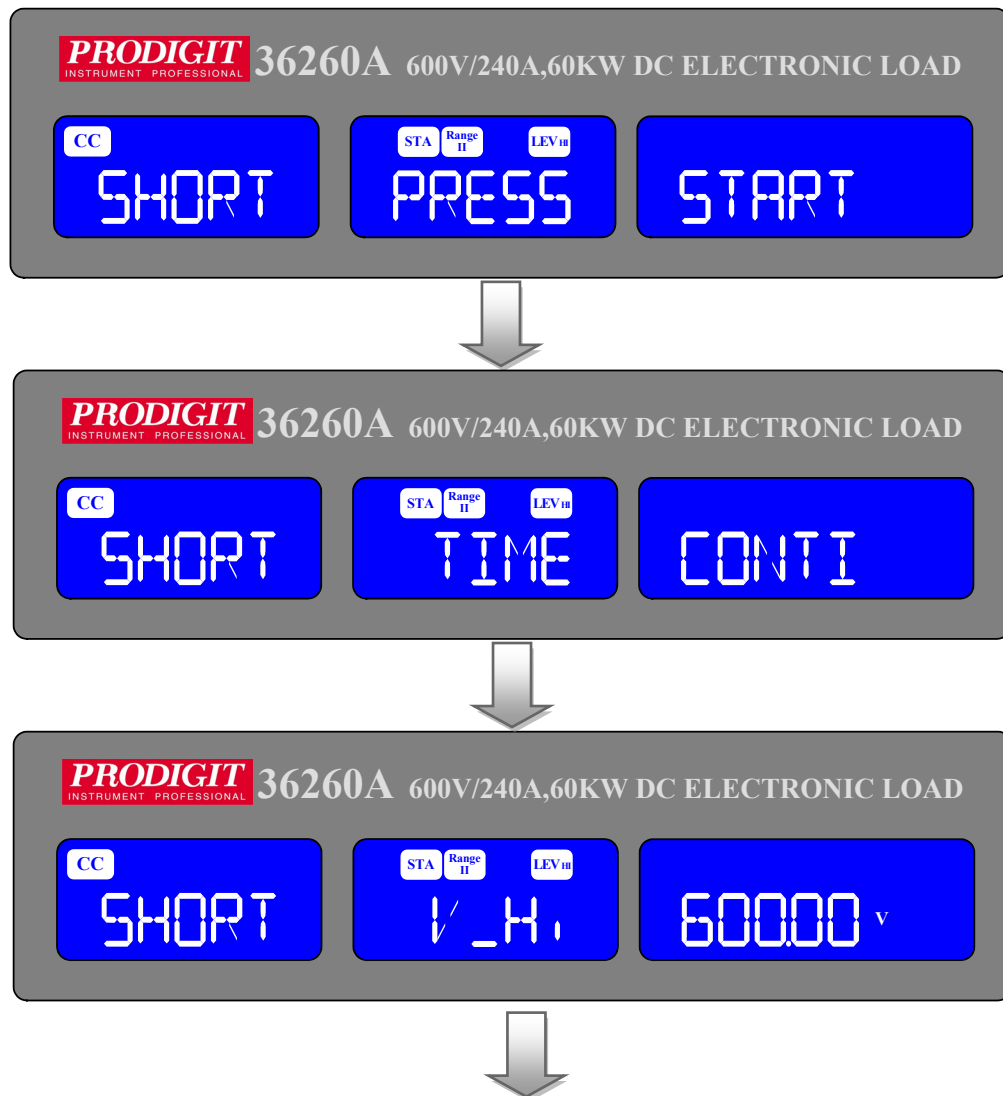

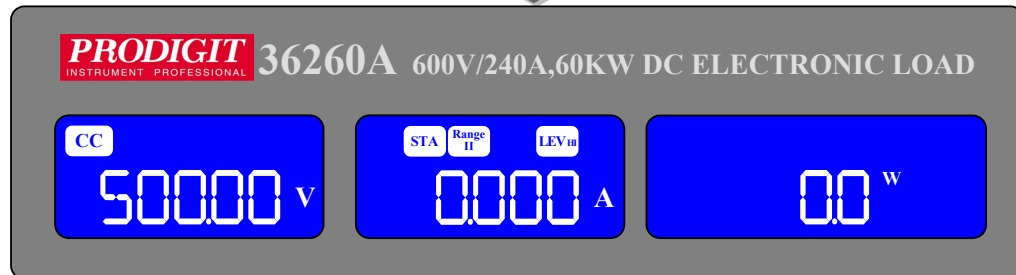
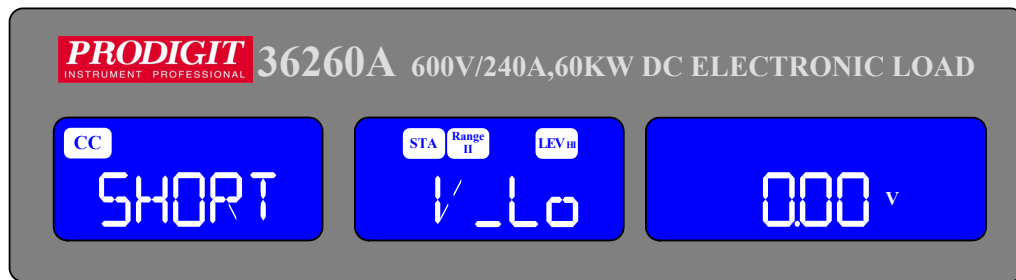

- setting the short test time , The LCD display show “SHORT” on Left 5 digits LCD display , shows “TIME” on middle 5 digits LCD display , Right 5 digit LCD display “CONTI”, the unit is "ms".

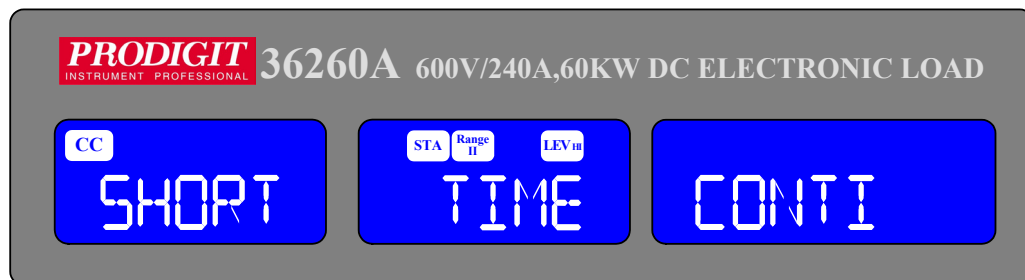

- TIME: setting the short test time, The LCD display show “ SHORT” on Left 5 digits LCD display, shows “ TIME” on middle 5 digits LCD display the unit is “ms” ,and shows “ CONTI “ on Right 5 digits LCD display, the setting range is “CONTI” means continue, 100mS to 10000mS step 100Ms by clockwise rotate the setting knob.

The short test will be no time limitation when setting to CONTI until press “START/STOP” key to stop the short test.

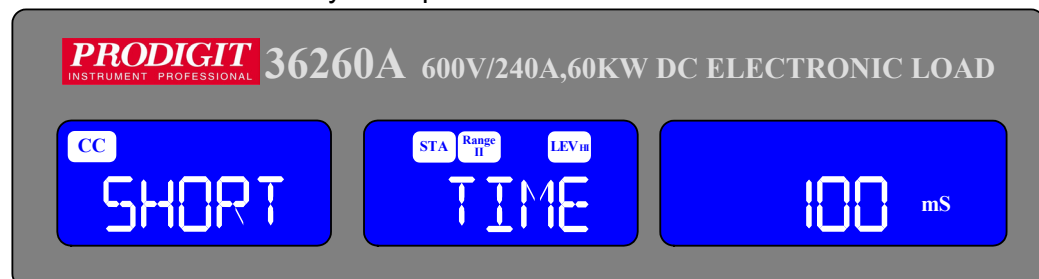

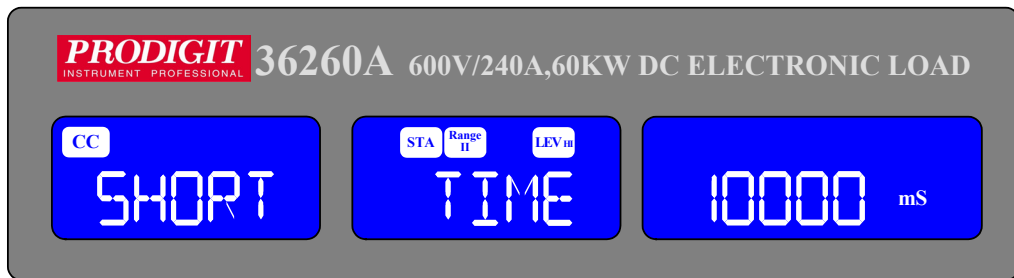

- V-Hi : Short test voltage check upper limitation setting, The LCD display Shows "SHORT" on Left 5 digit LCD display, Middle 5 digit LCD display "V-Hi" ,Right 5 digit LCD display setting value, the unit is "V", The V-Hi setting range from 0.00V to 600.00V step 0.01V by rotating the setting knob.

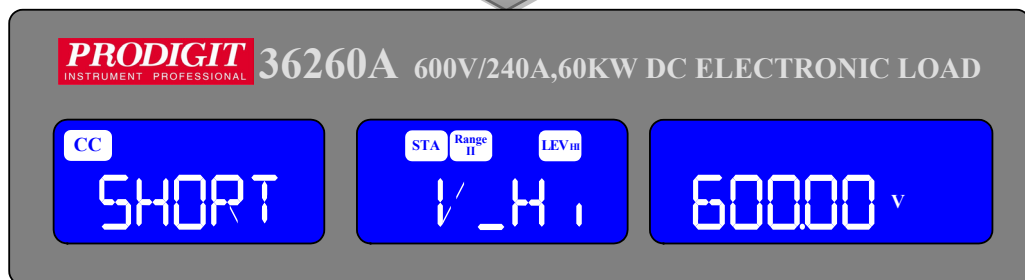
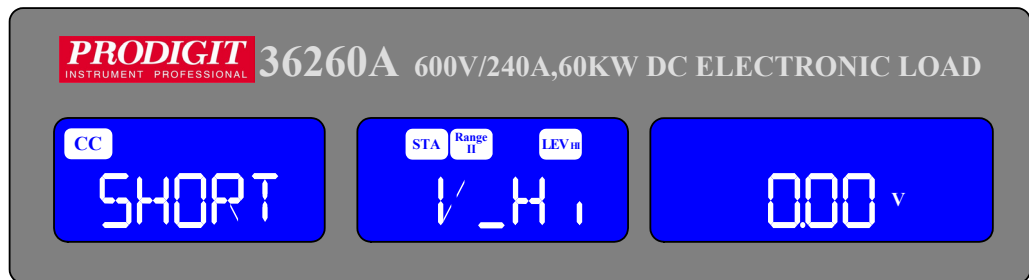

- V-Lo : Short test voltage check lower limitation setting, The LCD display shows "SHORT" on Left 5 digit LCD display, Middle 5 digit LCD display "V-Lo" ,Right 5 digit LCD display setting value, the unit is "V", the V-Hi setting range from 0.00V to 600.00V step 0.01V by rotating the setting knob.

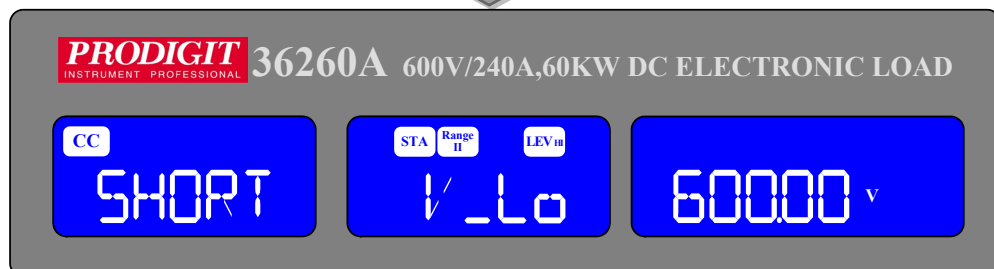
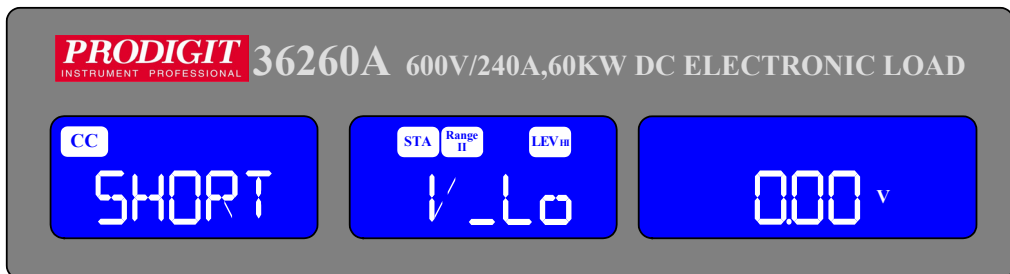

Once the test parameters have been entered the test is started by pressing The red START/STOP button while the SHORT PRESS START text is displayed. During the test the bottom LCD will show run and the actual short Current will be displayed on the middle LCD.

- Note 1: The message PASS END will be displayed if the measured voltage levels stays within the V_Hi and V_Lo threshold levels during the test.
- Note 2: The message FAIL END will be displayed if the measured voltage levels falls outside the V_Hi and V_Lo threshold levels during the test. The NG flag will also illuminate.
- Note 3: If continuous short time is selected the test is ended by pressing the red START/STOP button.

3.2.18. **OCP** key

The OCP key allows the parameters of an Over Current Protection test to be entered. The OCP test will ramp up the load current in steps to validate the Device Under test's (DUT) protection and behavior. A voltage threshold level can be set. If the voltage measured during the test is lower than the set Threshold voltage then the test will fail and the display will signal OCP ERROR. Similarly a current Threshold (I STOP) can be set. If the measured Current reaches the I STOP Threshold the test will be discontinued and the OCP ERROR message will be displayed.

Pressing the OCP key once will cause the button to illuminate. The message "OCP PRESS START" will be shown across the 3 displays.

Each press of the OCP button moves the menu on one step. The Left and Middle LCDs show the currently selected test parameter as text. The value is adjusted by the rotary knob and can be read from the Right display during Setting.

The setting sequence is shown below:

- OCP PRESS START (pressing the red start/stop key starts test) →
- OCP I STAR (current starting point of the OCP test) →
- OCP I STEP (value of incremental current steps from I START) →
- OCP I STOP (the OCP test's upper current threshold) →
- OCP Vth (the voltage threshold setting) →
- Exit OCP test set-up

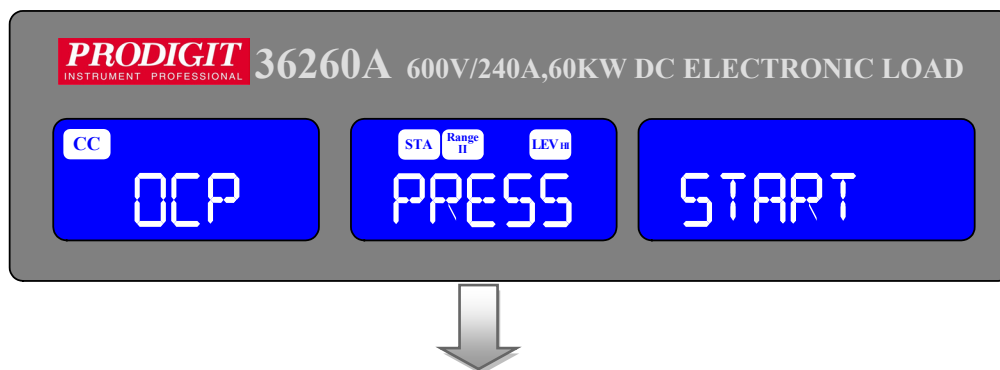

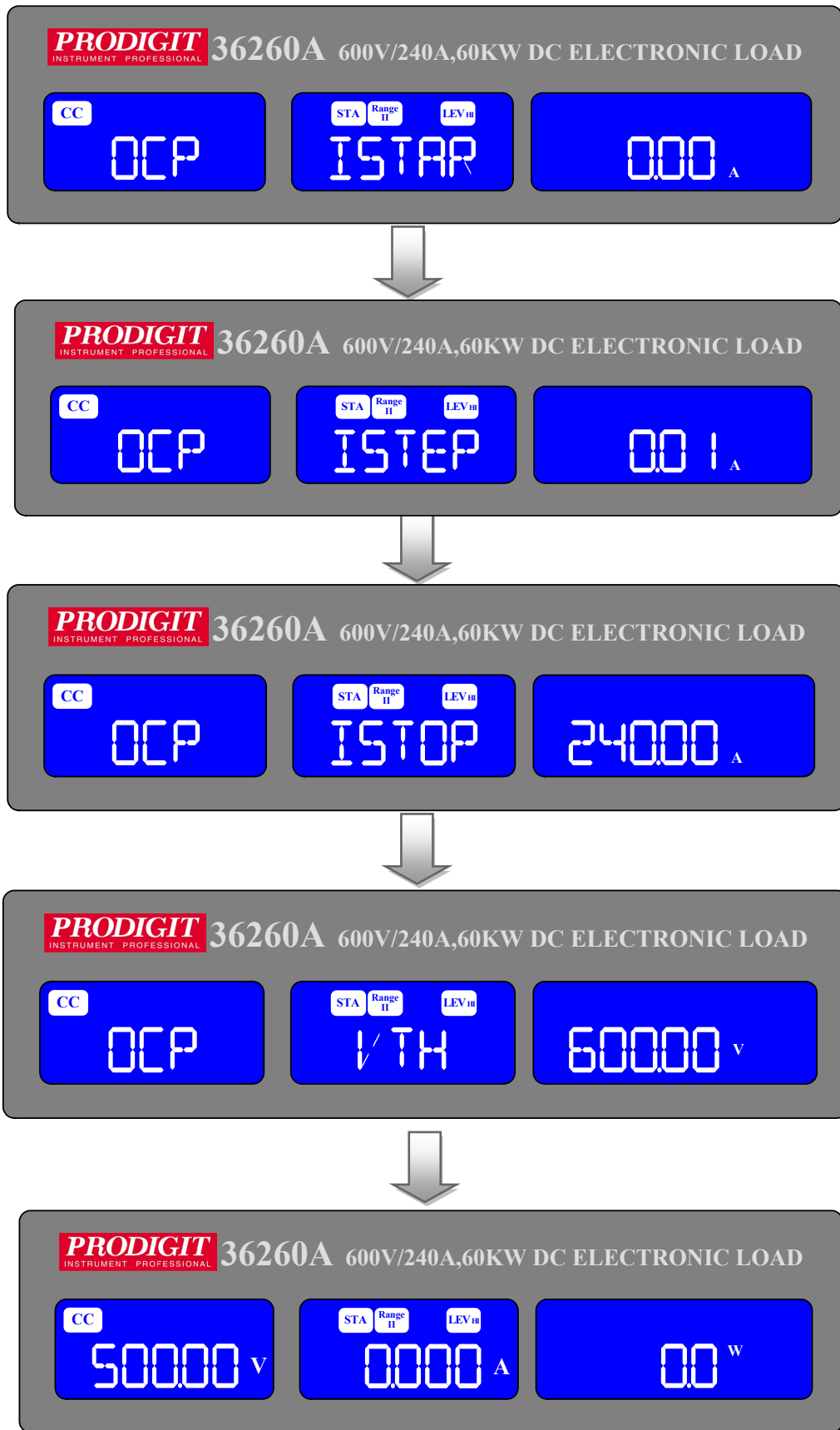

- ISTAR: setting the start current point, The LCD display shows "OCP" on Left 5 digit LCD display, Middle 5 digit LCD display "ISTAR", Right 5 digit LCD display setting value, the unit is "A".
The setting range is 0.00A to the full scale of the CC mode specification.
The setting is by rotating the setting knob.

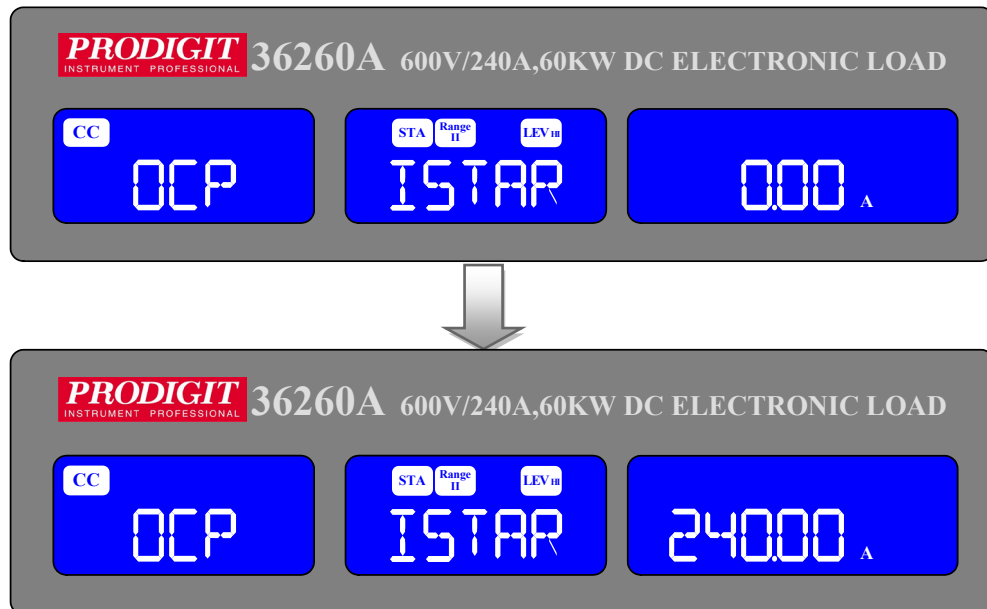

- ISTEP: setting the increment step current point, The LCD display shows "OCP" on Left 5 digit LCD display, Middle 5 digit LCD display "ISTEP", Right 5 digit LCD display setting value, the unit is "A".
The setting range is 0.01A to the full scale of the CC mode specification.
The setting is by rotating the setting knob.

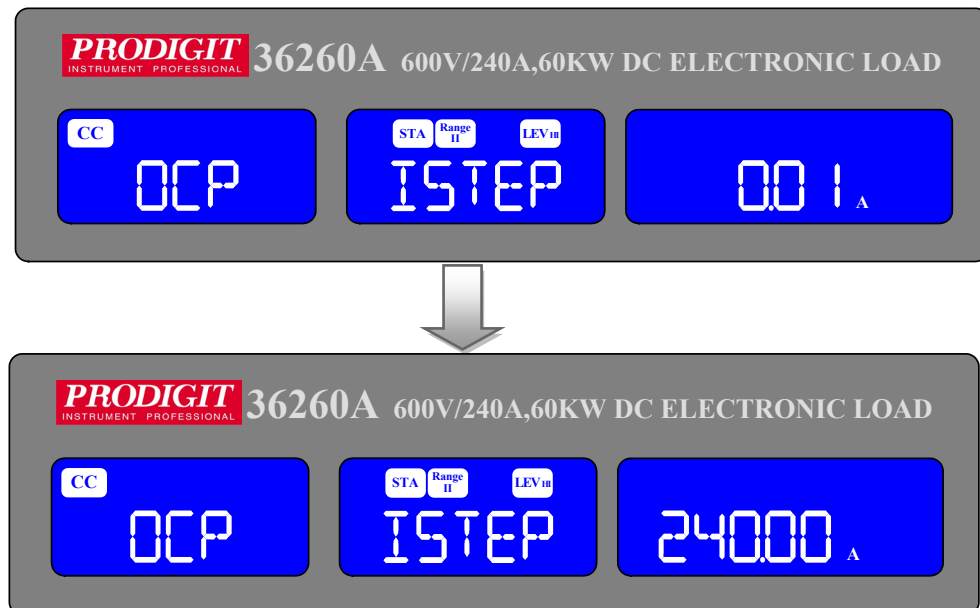

- **ISTOP**: setting the stop current point, The LCD display shows "OCP" on Left 5 digit LCD display, Middle 5 digit LCD display "ISTOP" ,Right 5 digit LCD display setting value, the unit is "A", the setting range is 0.000A to the full scale of the CC mode specification. The setting is by rotating the setting knob.

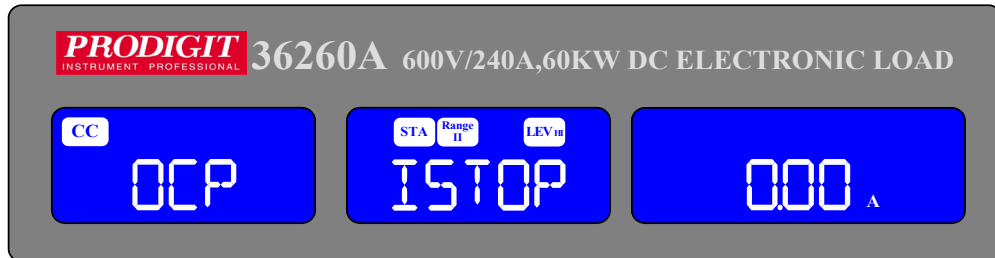

- **Vth**: Setting threshold voltage; The LCD display shows "OCP" on Left 5 digit LCD display, Middle 5 digit LCD display "Vth" ,Right 5 digit LCD display setting value, the unit is "V", the setting range is 0.00V to the full scale of the Voltage specification. The setting is by rotating the setting knob.

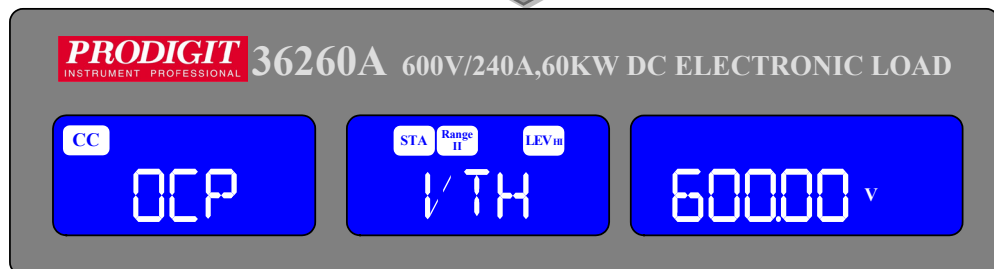
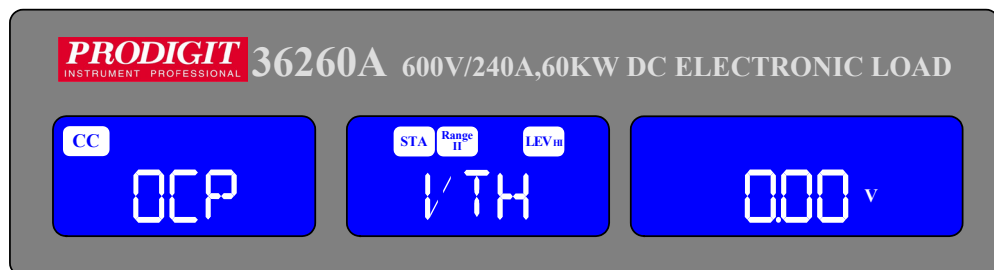

Once the test parameters have been entered the test is started by pressing the red START/STOP button while the OCP PRESS START text is displayed. During the Test the middle LCD will show run and the actual current being Taken will be displayed on the Right LCD

Note 1: The message OCP ERROR will be displayed if the DUT fails the test. The reasons for failure are due to one of the following conditions:

- (a) the voltage level of the DUT falls below the set voltage threshold (OCP Vth) during the test
- (b) The current taken from the DUT reaches the OCP I STOP setting.

Note 2: The message PASS will be displayed if the DUTs voltage stays above The set threshold. Also to PASS the OCP test the current taken from the DUT cannot equal the I STOP setting.

Note 3: If the DUT passes the OCP test the maximum current taken during the Test is displayed on the right LCD.

Upon PASS or OCP ERROR the test will automatically stop. The red START/STOP button can be used during the test to immediately cease operation.

3.2.19. **OPP** Key

The OPP key allows the parameters of an Over Power Protection test to be entered. The OPP test will ramp up the load power in steps to validate the Device under Test's (DUT) protection and behavior. A voltage threshold level can be set. If the voltage measured during the test is lower than the set Threshold voltage then the test will fail and the display will signal OPP ERROR. Similarly a power threshold (P STOP) can be set. If the measured power reaches the P STOP threshold the test will be discontinued and the OPP ERROR message will be displayed.

Pressing the OPP key once will cause the button to illuminate. The message "OPP PRESS START" will be shown across the 3 displays.

Each press of the OPP button moves the menu on one step. The Left and Middle LCDs show the currently selected test parameter as text. The value is adjusted by the rotary knob and can be read from the Right display during Setting.

The setting sequence is shown below:

OPP PRESS START (pressing the red start/stop key starts test)	→
OPP P STAR (power starting point of the OPP test)	→
OPP P STEP (value of incremental current steps from P START)	→
OPP P STOP (the OPP test's upper threshold power limit)	→
OPP Vth (the voltage threshold setting)	→
Exit OPP test set-up	

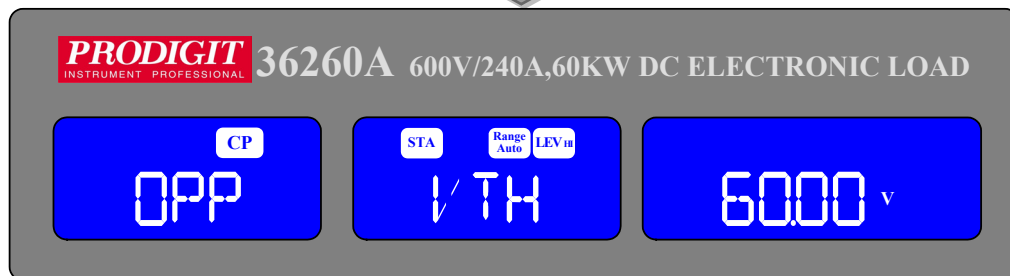
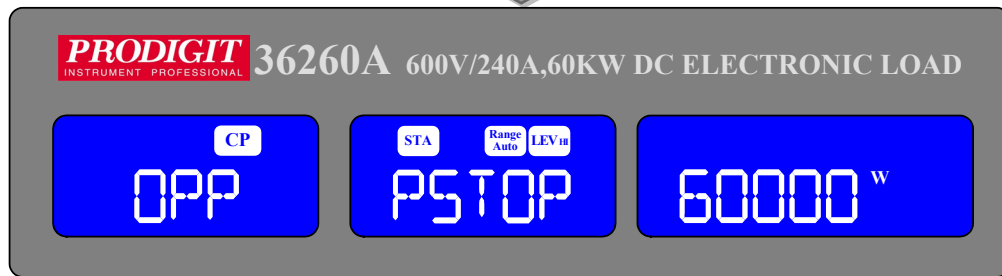
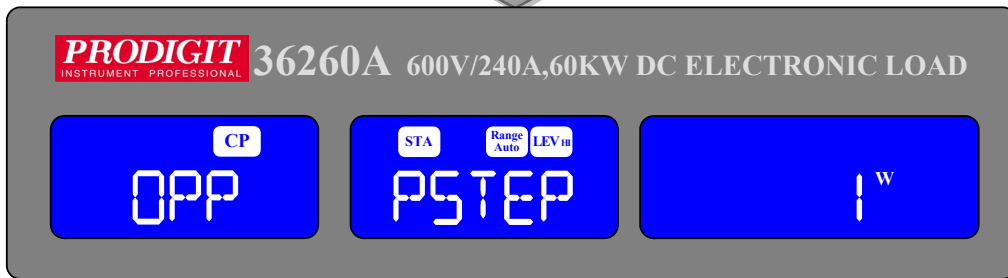
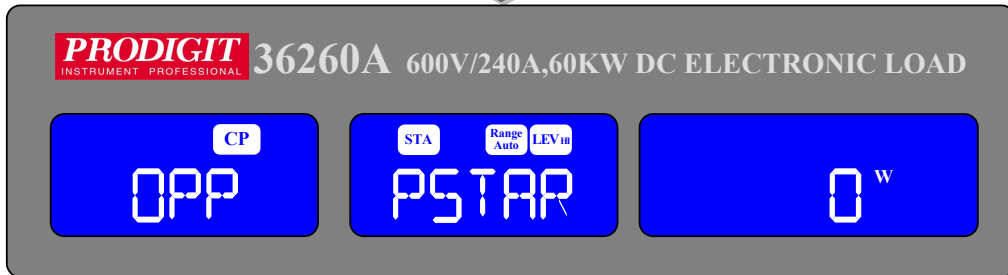
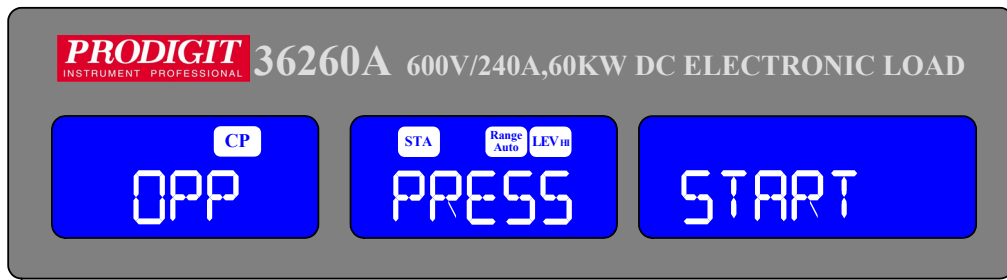

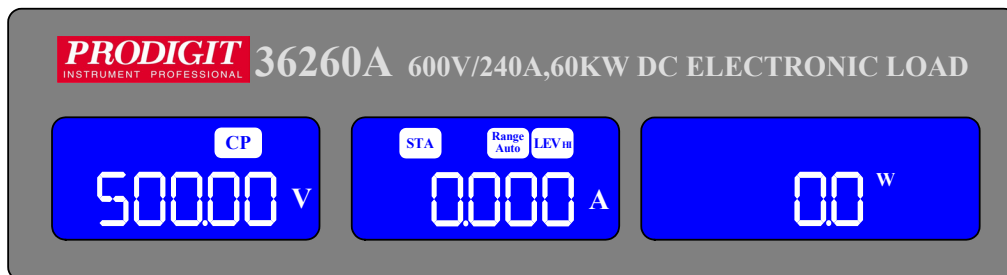

- PSTAR: setting the start power, The LCD display shows “OPP” on Left 5 digit LCD display, Middle 5 digit LCD display “PSTAR” ,Right 5 digit LCD display Setting value, the unit is "W", the setting range is 0.00W to the full scale of The CP mode specification. The setting is by rotating the setting knob.

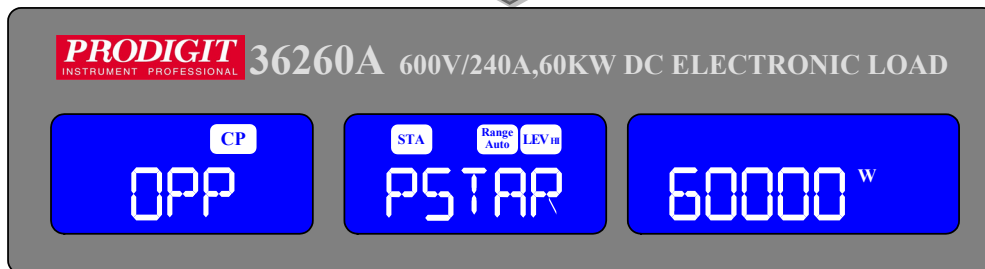
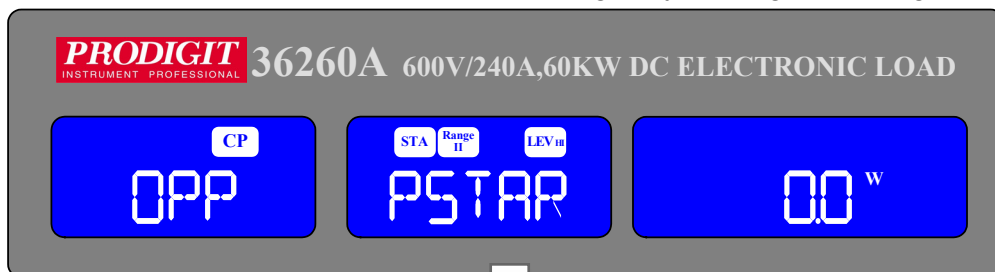

- PSTEP: setting the increment step power, The LCD display shows “OPP” on Left 5 digit LCD display, Middle 5 digit LCD display “PSTEP” ,Right 5 digit LCD display setting value, the unit is "W", the setting range is 1W to the full scale of the CP mode specification. The setting is by rotating the setting knob.

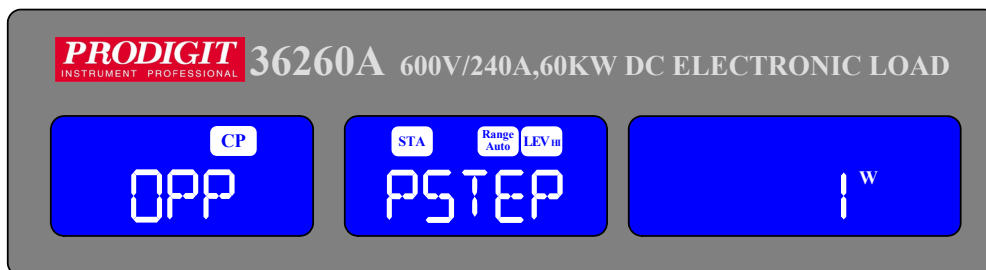

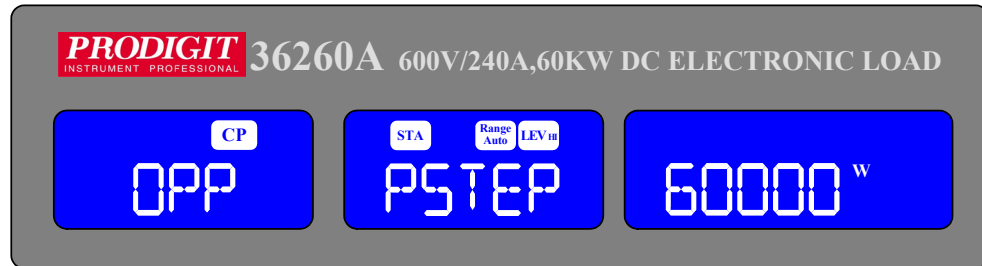

- PSTOP: setting the stop power, The LCD display shows “OPP” on Left 5 digit LCD display, Middle 5 digit LCD display ”PSTOP” ,Right 5 digit LCD display setting value, the unit is "W", the setting range is 0.00W to the full scale of the CP mode specification. The setting is by rotating the setting knob.

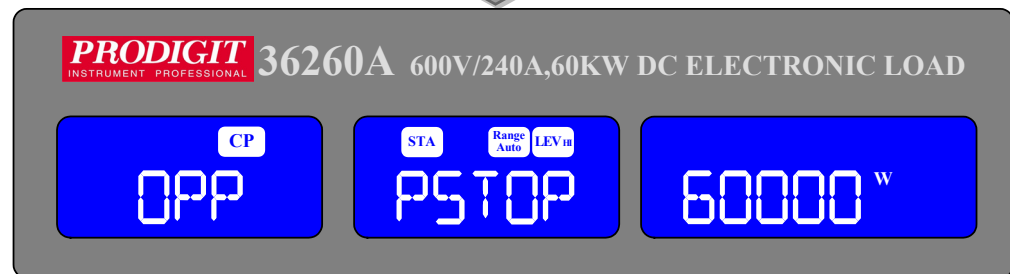
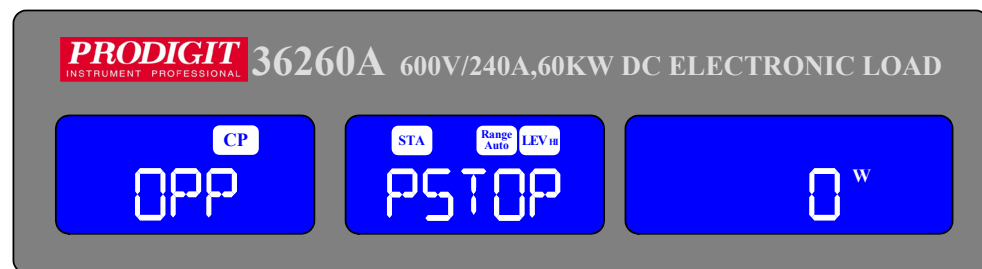

- Vth : Setting threshold voltage; The LCD display shows “OPP” on Left 5 digit LCD display, Middle 5 digit LCD display” Vth” ,Right 5 digit LCD display setting value, the unit is "V", the setting range is 0.00V to the full scale of the Voltage specification. The setting is by rotating the setting knob.

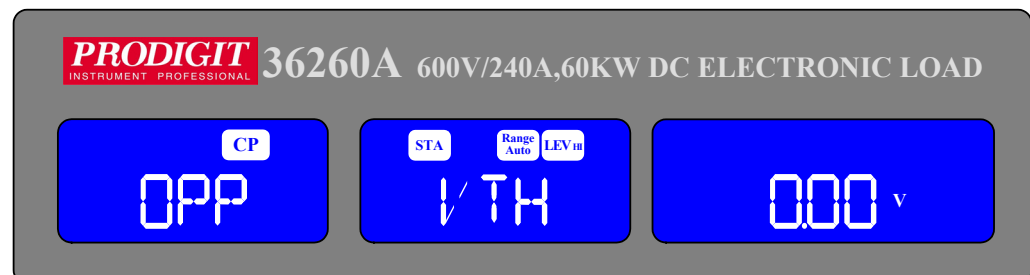

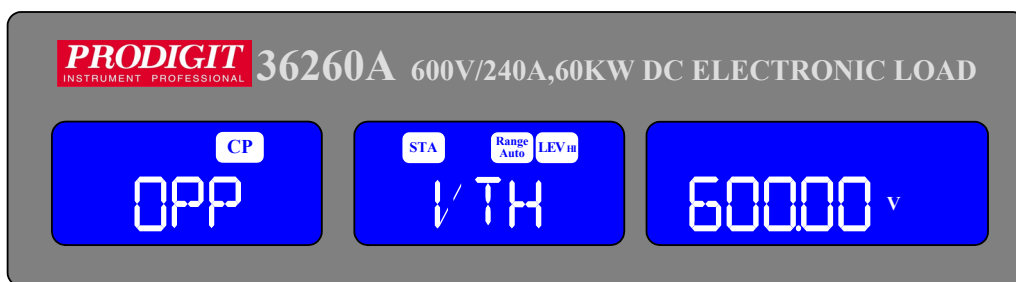

Once the test parameters have been entered the test is started by pressing the red START/STOP button while the OPP PRESS START text is displayed. During the test the middle LCD will show run and the actual power being taken will be displayed on the right LCD.

Note 1: The message OPP ERROR will be displayed if the DUT fails the test. The reasons for failure are due to one of the following conditions:

- (a) The voltage level of the DUT falls below the set voltage threshold (OPP Vth) during the test
- (b) The current taken from the DUT reaches the OPP P STOP setting.

Note 2: The message PASS will be displayed if the DUTs voltage stays above the set Threshold. Also to PASS the OPP test the current taken from the DUT cannot Equal the I STOP setting.

Note 3: If the DUT passes the OPP test the maximum power taken during the test is Displayed on the right LCD.

Upon PASS or OPP ERROR the test will automatically stop. The red START/STOP button can be used during the test to immediately cease operation.

3.2.20.  key

The red START/STOP key is used in conjunction with the SHORT, OCP or OPP test functions. It is used to START a test according to the set parameters or to STOP a test before PASS or FAIL is signaled. Please refer to the preceding sections for more information on the SHORT, OCP & OPP tests.

3.2.21. ROTARY Knob and ARROW Keys

The ROTARY knob and ARROW keys are used to increase or decrease the set values.

- CLOCKWISE operation of the ROTARY Knob increases the setting value.

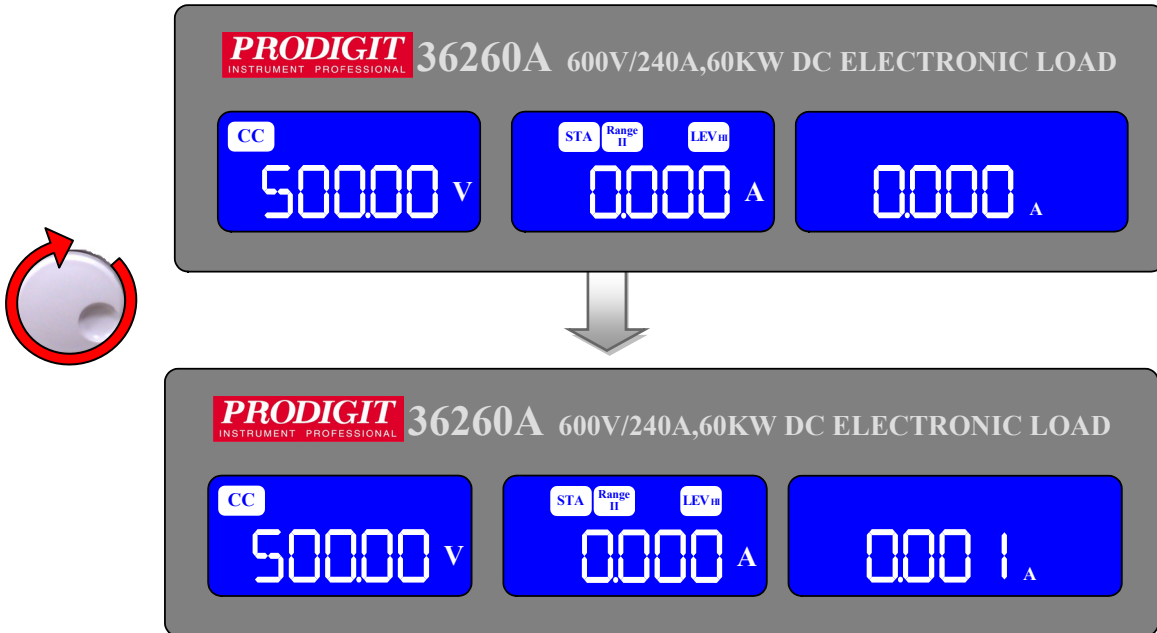

- ANTI-CLOCKWISE operation of the ROTARY Knob decreases the setting value.

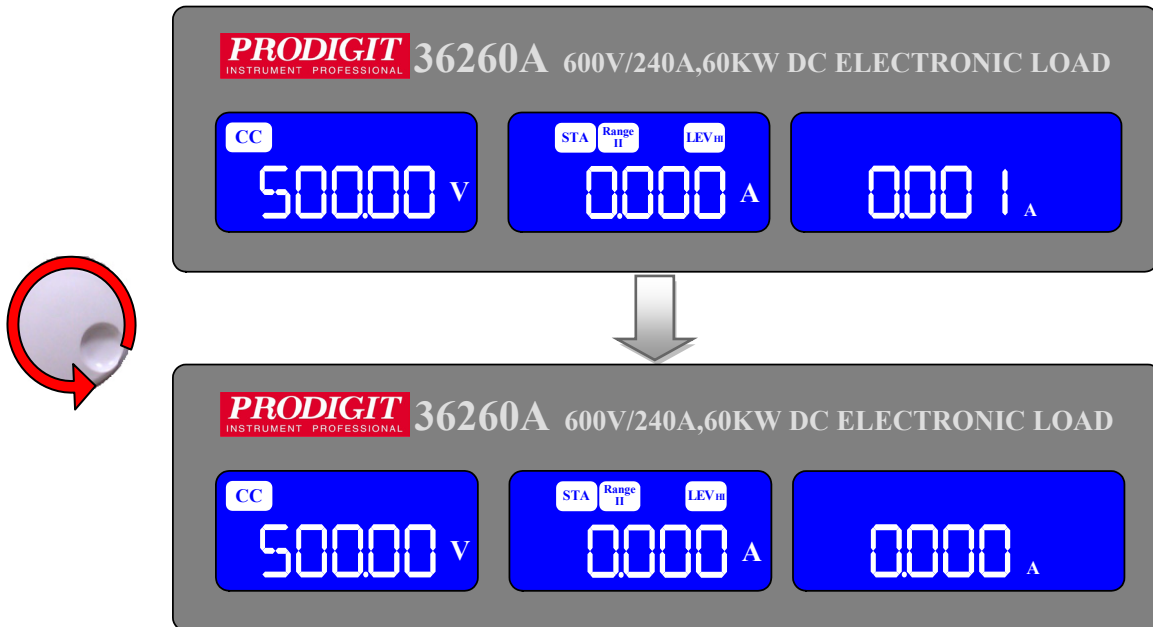

- UP ARROW key increases the setting value.

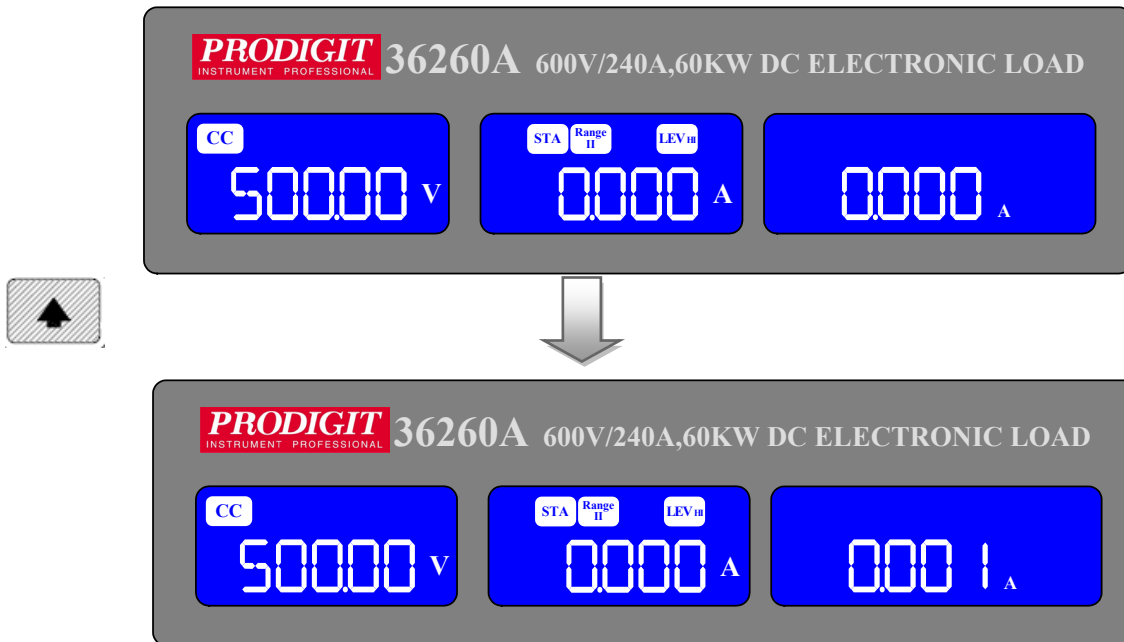

- DOWN ARROW key reduces the setting value.

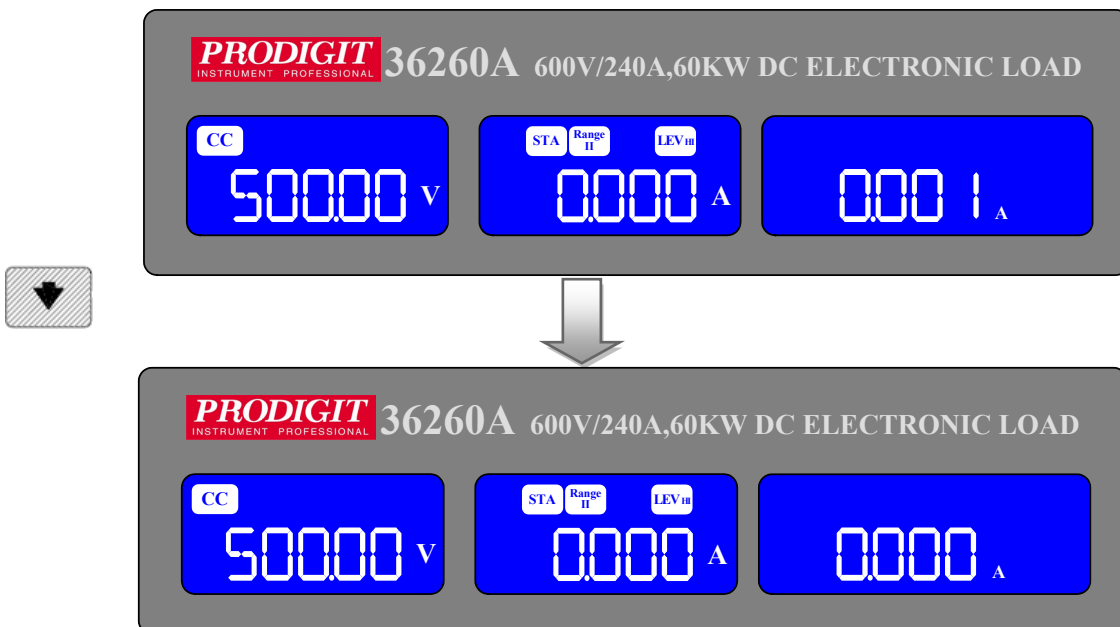

- Keypad KEY : When using the Keypad, please enter the number, press the Enter key.

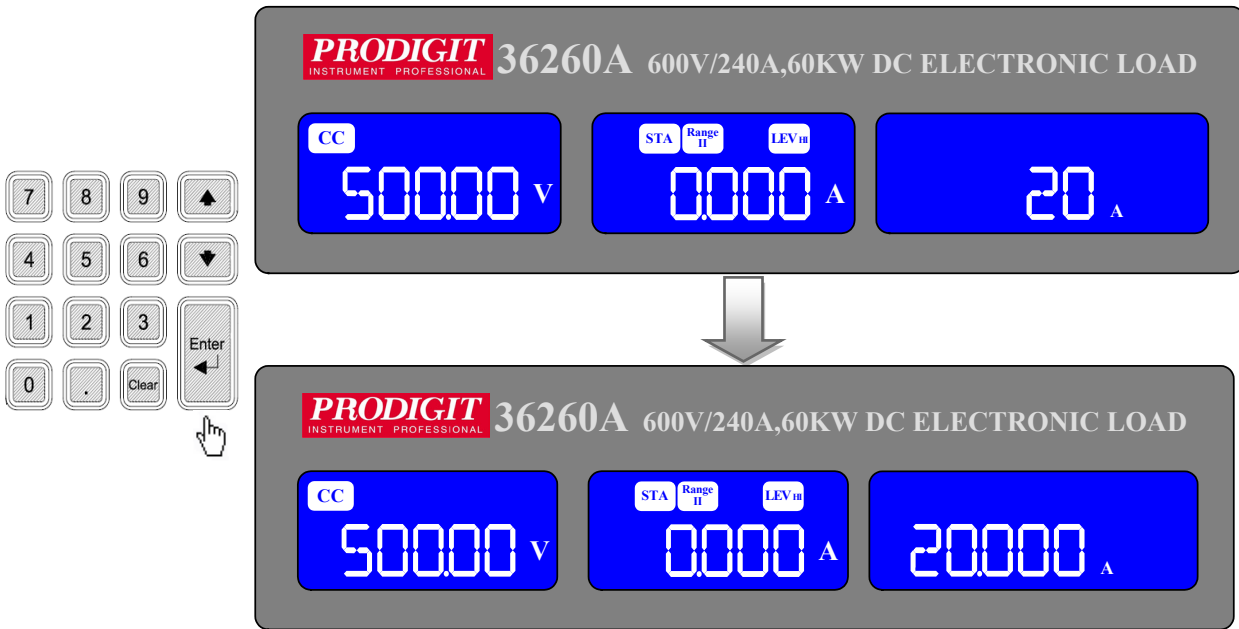

- Clear KEY : Setting, press the Clear key to clear the input value.

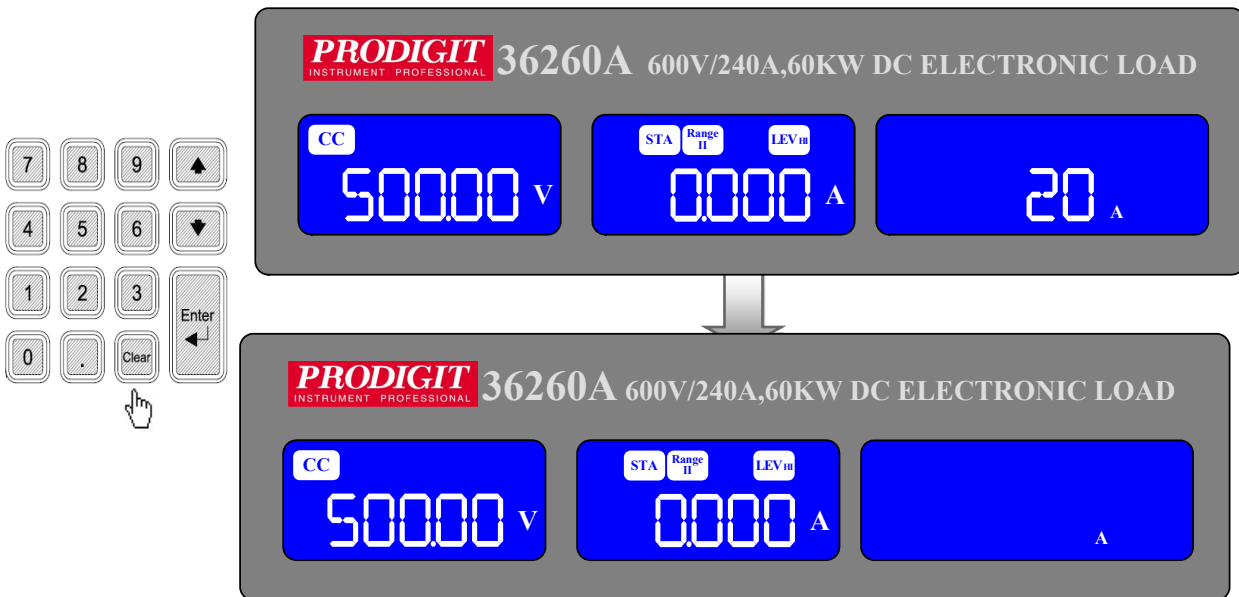

Note 1: In CR MODE the UP ARROW key and CLOCKWISE operation of the ROTARY Knob reduces the resistance.

Note 2: In CR MODE the DOWN ARROW key & ANTI-CLOCKWISE operation of the ROTARY Knob increases the resistance.

3.2.22. DC INPUT Terminal.

The positive (LOAD +) and negative (LOAD -) power input terminals are clearly marked. DO NOT confuse them with the smaller SENSE terminals.

Please ensure that the voltage and current rating of the DUT do not exceed the maximum rating of the 36000A Series load module being used. Please also check the output polarity of the DUT prior to connection and testing.

The negative load terminal should be connected to ground if testing a positive output power supply. This is normally achieved when the negative output of the power supply is grounded.

Similarly if a power supply with a negative output is to be tested then the positive Load terminal should be grounded. This is normally achieved when the positive Output of the power supply under test is grounded.

3.2.23. V-sense input terminal

The V-sense terminals can be used to compensate for a voltage drop in the load lines between the power supply and the 36000A series Electronic Load. This is a useful feature useful when the load current is relatively high.

If remote sense is required the V-sense terminals are connected to the appropriate positive and negative terminals of the power supply as shown in Fig 3-2. In the CONFIG menu the V-sense function can be set to AUTO or ON.

Please note that if V-sense is set to AUTO and the sense leads are connected to the DUT the losses need to be approx. 7V (36200A) or 13V (36300A) before the display Compensates for the voltage loss.

If V-sense is set to 'ON' and the sense terminals are connected to the DUT the load will check and compensate for all voltage drops.

The maximum voltage sense compensation is the same as the rating of the 36000A series electronic load. For example the 36360A is capable of sinking current at up to 1000Vdc. Therefore the maximum V-sense is also 1000Vdc.

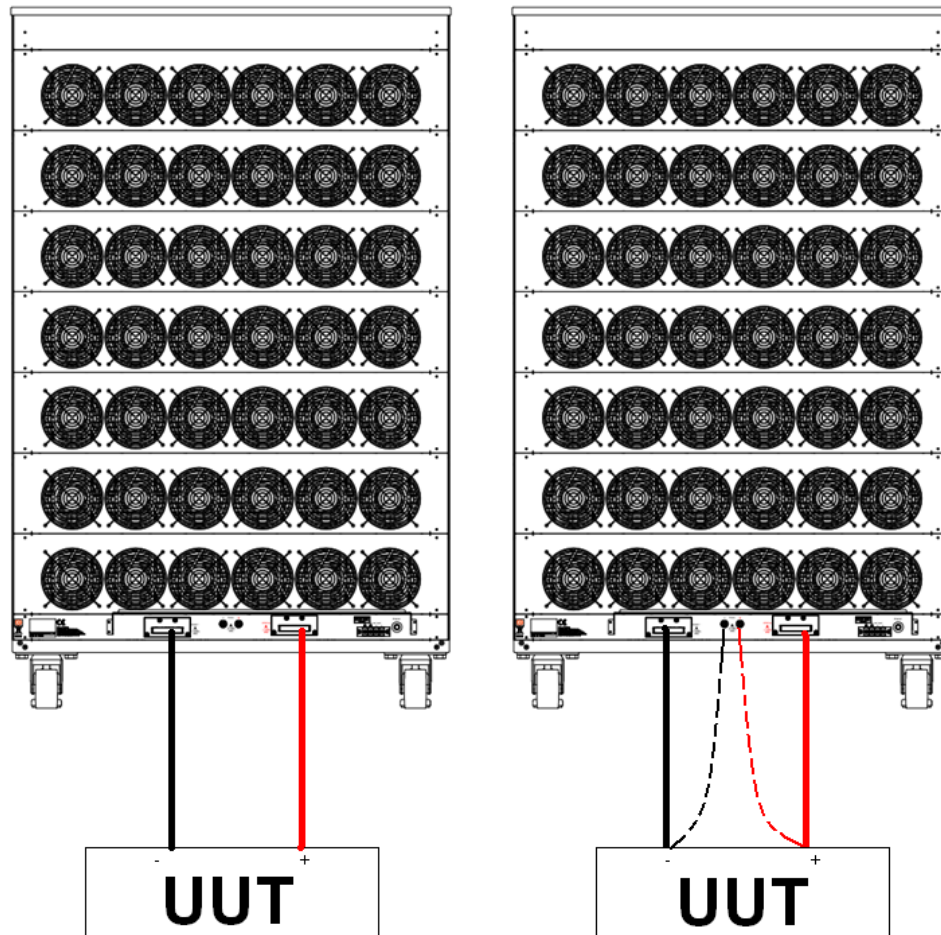

Fig 3-4 typical connection of 36000A series load module

3.2.24. I-monitor

The I-monitor is provided as a BNC socket. It is designed to enable the user to Monitor the Electronic Load's input current or short current. The I-monitor's signal is 0V to 10V. This signal is proportional to the full scale current that the particular Electronic Load is capable of.

For example. 36260A: $I_{max} = 240A$ therefore I-monitor 10V = 240A so 1V = 24A

Please refer to the specification Fig 1-1.1 to Fig1-1.20 for the maximum current that each 36000A series Load is capable of.



The current monitor of this unit is NOT isolated. Please be careful when you connect an oscilloscope. Improper connections are likely to cause damage. Please follow the connection rule on the following page.

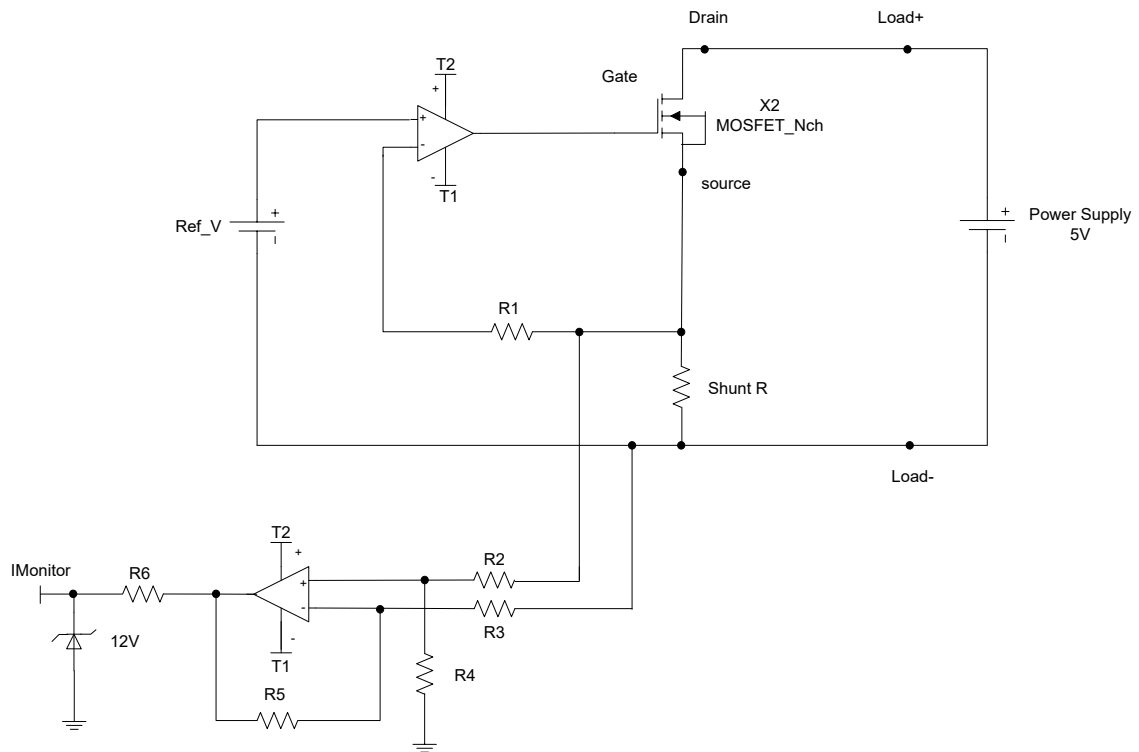

Fig 3-5 An equivalent circuit in terms of the current monitor

Connecting the I-monitor to an oscilloscope

When you connect this product to an oscilloscope, please ensure the correct polarities of the connecting probes as shown in Fig. 3-6.

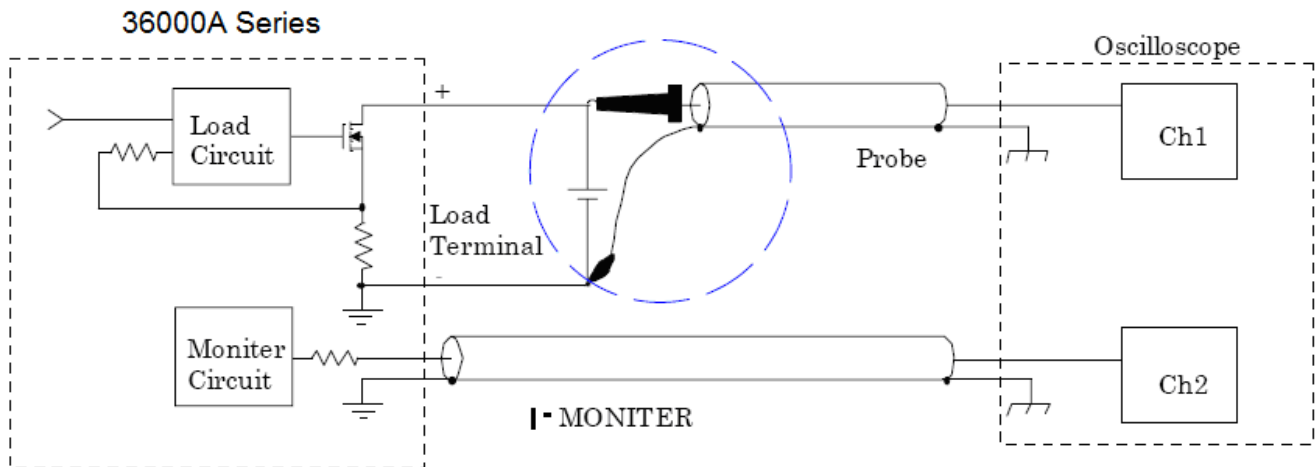

Fig 3-6 (Correct) Connections to an oscilloscope

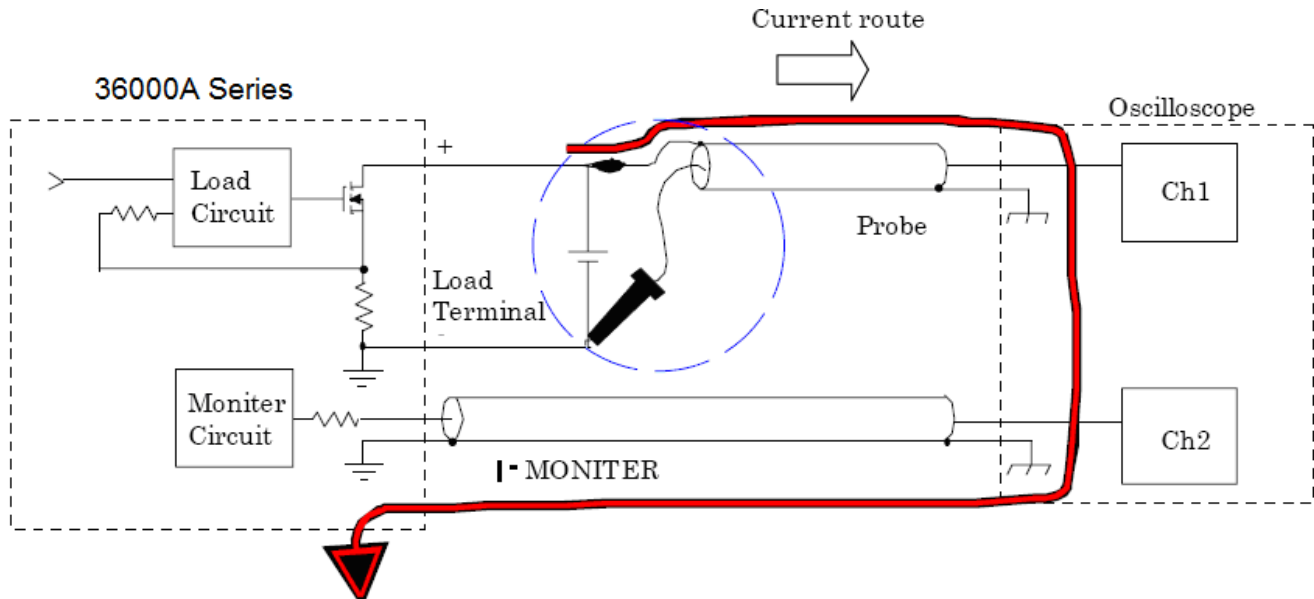

Fig 3-7 (Wrong) Connections to an oscilloscope

If the probes connection is reversed as shown in Fig 3-7, a large current would flow through the probe and the internal circuitry of the oscilloscope is likely to be damaged.

3.2.25. Analog programming input

The Electronic Load has an analog programming input on the rear panel of the mainframe. The analogue programming input enables the load module to track and load according to an external 0-10V (ac or ac + dc) signal.

The analog programming input is configured as a BNC socket on the mainframe's rear panel.

The analogue programming input operates in CC or CP modes only. The 36000A series Load will attempt to load proportionally according to the signal and the load module's maximum current or power range. For example: 36260A: $I_{max} = 240A$ and $P_{max} = 60000W$

So in CC mode if analogue programming input is 5V = 120A load setting (Range II)
Or in CP mode if analogue programming input is 1V = 6000W load setting (Range II)

In the Constant Current mode, 0V to 10V analog input signal can be set to 0A to full scale of the load current to 36260A 600V / 240A / 60KW electronic load, the load current is set to less than 24A, 10V analog input signal can Produce a load current of 24A, when the load current is greater than 24A, 10V analog input signal can produce 240A load current.

In the Constant power mode, 0V to 10V analog input signal can be set to 0W to full scale of the load power to 36260A 600V / 240A / 60KW electronic load, the load

Power is set to less than 6000W, 10V analog input signal can Produce a load Power of 6000W, when the load power is greater than 6000W, 10V analog input signal can produce 60000W load power.

Note: The above operation must be LOAD OFF

The analog programming signal can act alone or it can be summed with the programmed value set via the front panel or the optional computer interface (GPIB, RS-232, USB, or LAN) or the front panel.

Example:

Fig 3-8 shows the result of an analog programming signal at 4 Vac, 500Hz when it is summed with a 96A programmed setting in CC mode of 36260A Load.

Note: The above operation must be LOAD ON

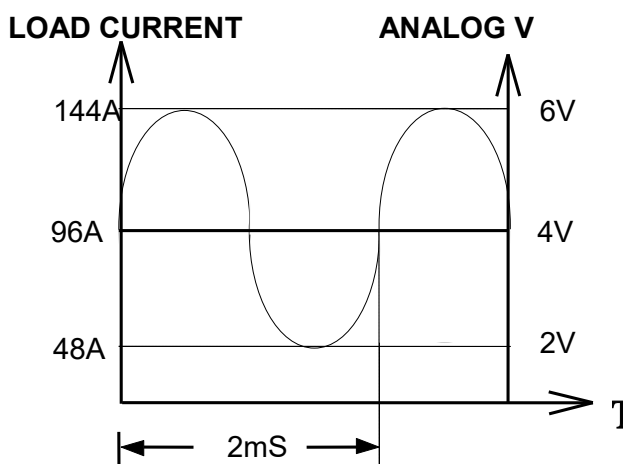
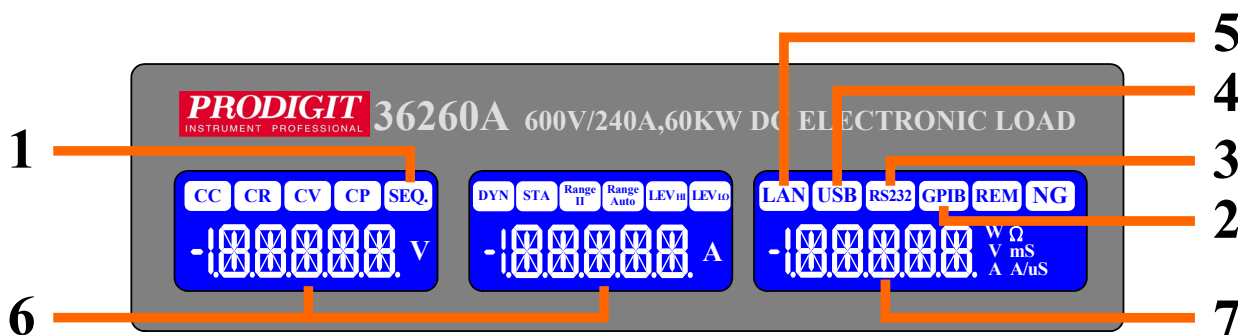

Fig 3-8 Analog programming example

3-3. 36000A Series Operating Instructions (1)

36000A series of LCD displays status, details are as follows:



- 3.3.1. SEQ. indicator when entering AUTO SEQUENCE mode, LCD indicator will light up.
- 3.3.2. In GPIB mode:
It is GPIB inside. The LCD will be lit GPIB when Power ON. If 36000A series is controlled by GPIB through PC, the GPIB will be lit.
- 3.3.3. In RS232 mode:
It is RS232 inside. The LCD will be lit RS232 when Power ON. If 36000A series is

controlled by RS232 through PC, the RS232 will be lit.

- 3.3.4. USB mode Lit :
It is USB interface inside.
- 3.3.5. LAN mode Lit :
It is LAN interface inside.
- 3.3.6. Status display:
When enter System Setting or AUTO SEQUENCE, the display setting item.
- 3.3.7. Setting display:
Display System Setting state or AUTO SEQUENCE setting value.

3-4. 36000A Series System Operating Instructions (2)

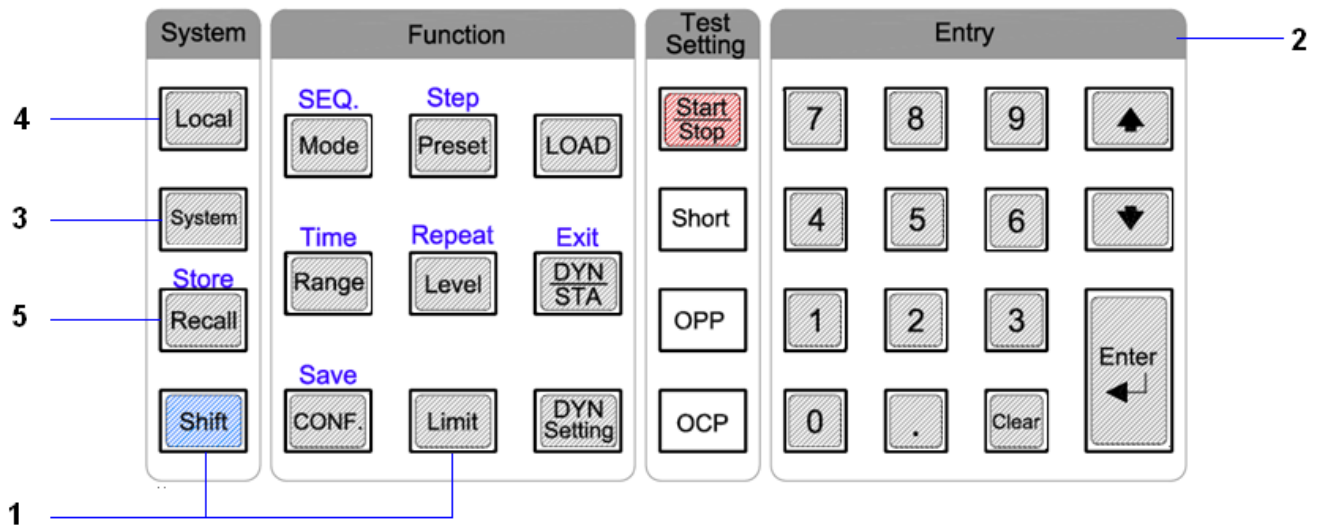

- 3.4.1. Shift key to switch the key to the second function key.
- 3.4.2. KEYPAD KEY: AUTO SEQUENCE edits the settings, test and RECALL / STORE key.
- 3.4.3. SYSTEM: Press SYSTEM to set the argument ,GPIB address,RS232 BAUD- RATE, WAKE UP and buzzer Alarm power ON/OFF and Master/Slave control.
- 3.4.4. Press LOCAL to exit REMOTE mode.
- 3.4.5. Recall / Store: Recall / Store LOAD state settings.

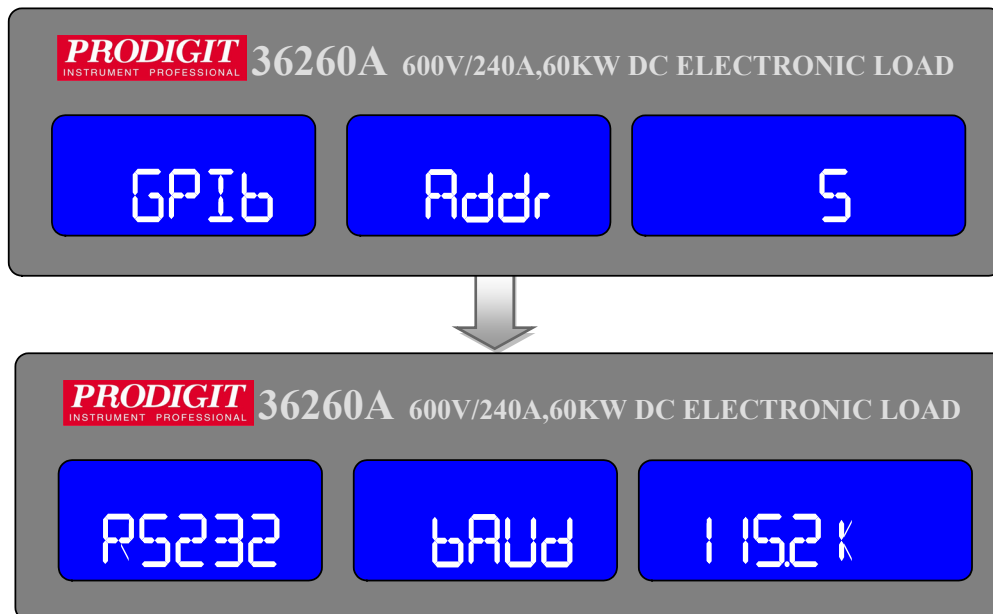

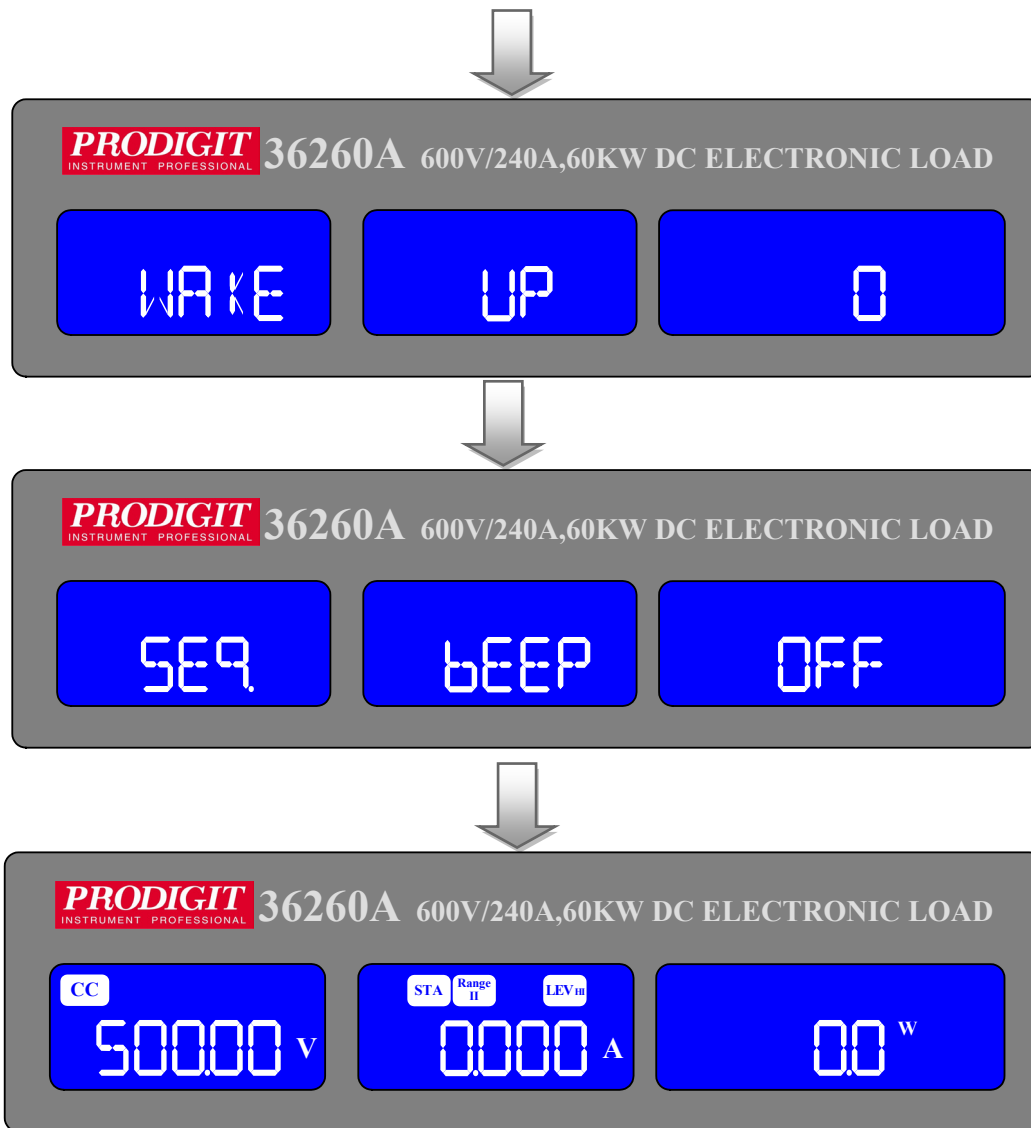

3-5. 36000A Series System Operating Instructions (3)

3.5.1. Setting system parameters

Set GPIB address, RS232 BAUD RATE, WAKE UP, Buzzer ON/OFF and Master/Slave Control.

- 3.5.1.1. Set GPIB address: First Press SYSTEM key, The LCD display shows “ GPIB” on left 5 digit LCD display, Middle 5 digit LCD display "Addr", right 5 digit LCD display setting GPIB address of the representative, Press UP, DOWN buttons to adjust the GPIB address 1~30, Key and then press ENTER, 36000A series GPIB Address value is saved, Press system key four times to leave the GPIB address configuration State.



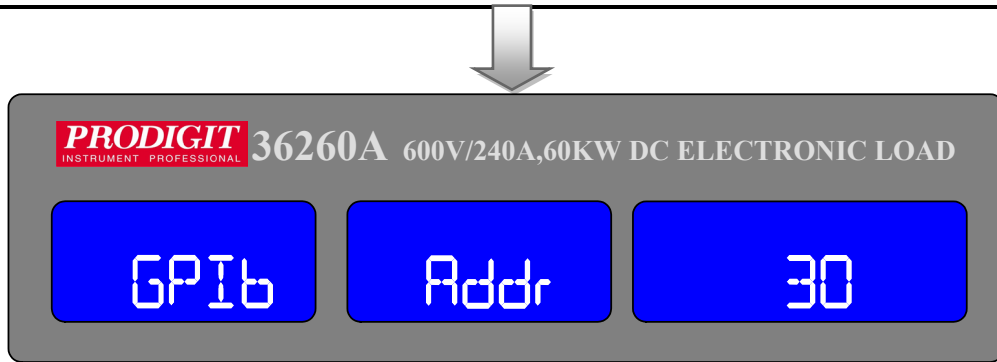

3.5.1.2. Set RS232 BAUD RATE :

SYSTEM key first by the second, The LCD display shows "RS232" on left 5 digit LCD display, Middle 5 digit LCD display "baud", right 5 digit LCD display setting BAUD-RATE, Press UP, DOWN buttons to adjust the value of BAUD RATE, Key and then press ENTER, 36000A series is saved setting BAUD RATE, press system key three times to leave the BAUD-RATE setting state.

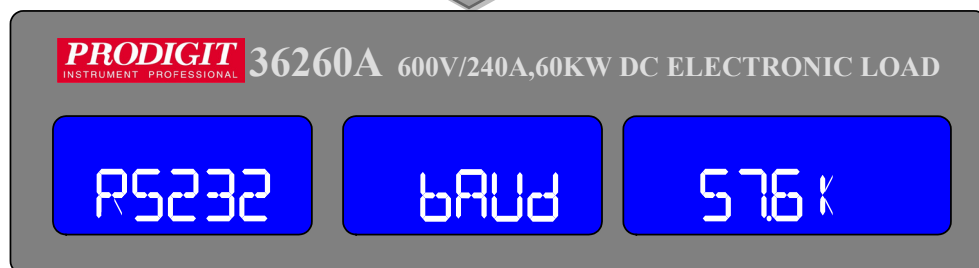

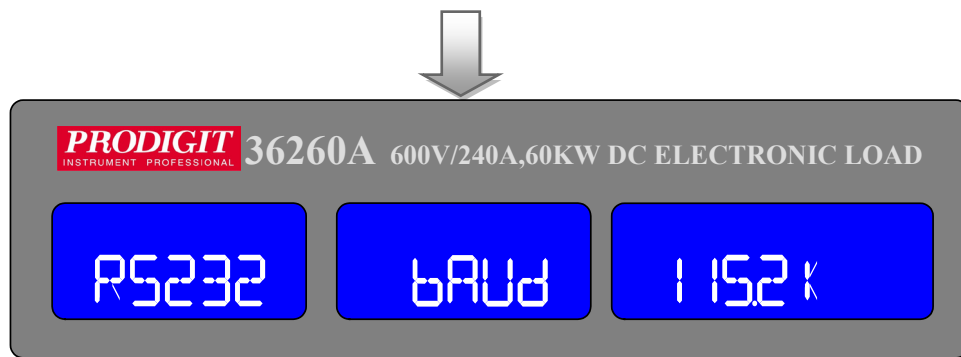

3.5.1.3. WAKE-UP function:

This function is designed for auto setting the load status and load level in turning on The 36000A series every time. SYSTEM key first by the three.

The LCD display shows "WAKE" on left 5 digit LCD display, Middle 5 digit LCD Display "UP", right 5 digit LCD display setting, Press UP, DOWN buttons to adjust the 0~150.

Press ENTER key to be stored, press system key two times to leave the WAKE-UP setting state, If set to "0" means do not call.

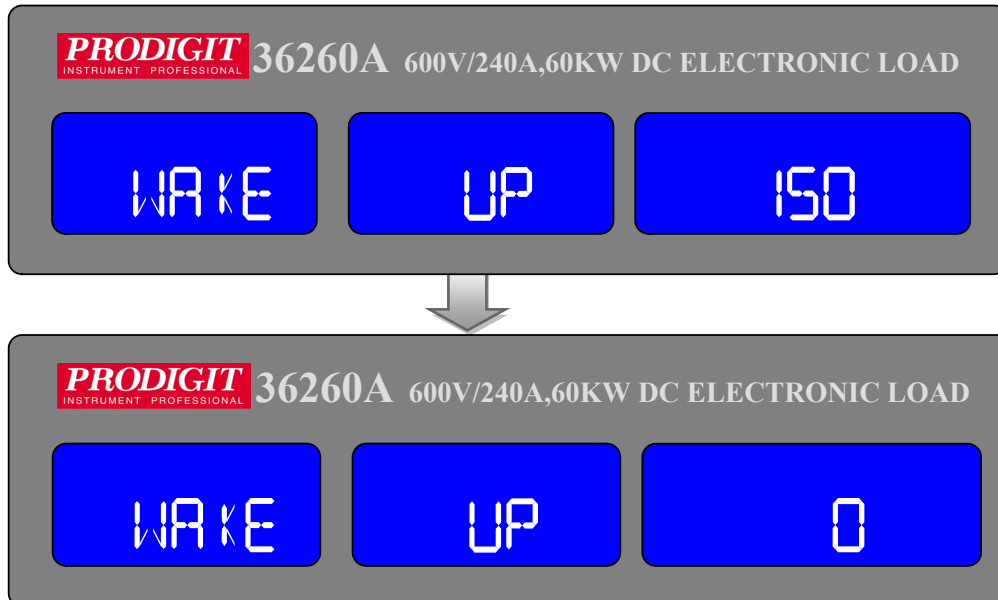

3.5.1.4. Buzzer ON / OFF:

This is the test set automatically (AUTO SEQUENCE) at the end, if it increases buzzer function, if set to ON, Then when the test result is PASS automatically when The buzzer will call out, if the test result is FAIL when the buzzer will call the second Tone.

Setting method:

First by 4 Times SYSTEM key and the LCD display shows "SEQ" on left 5 digit LCD Display, Middle 5 digit LCD display "Beep", right 5 digit LCD Display setting ON or OFF, press UP DOWN key to adjust.

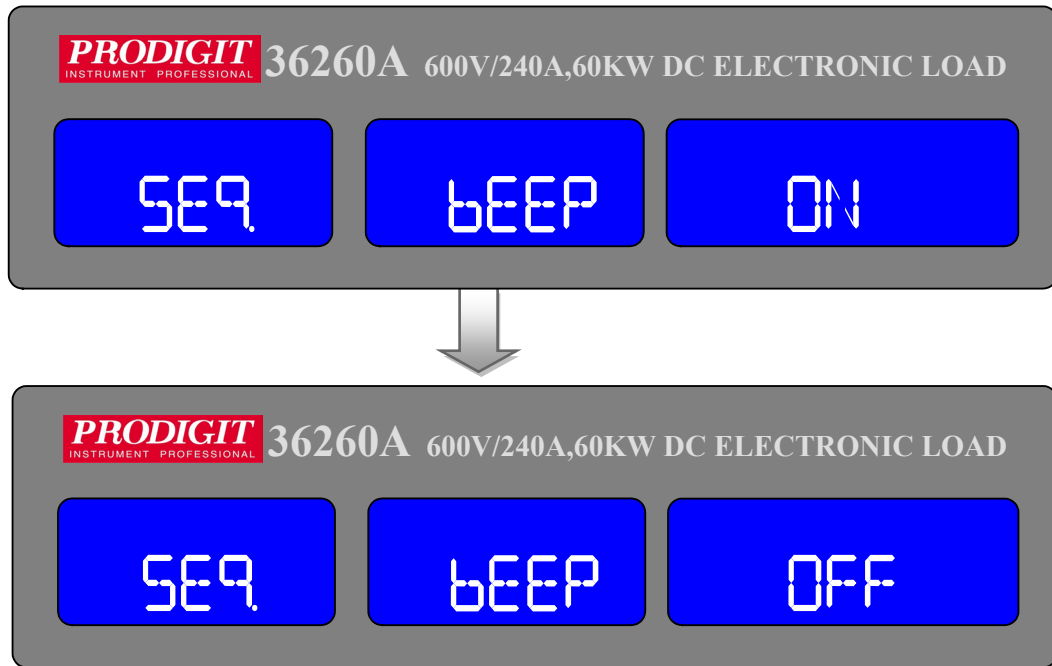

Note: setting system parameters, if the input is required to use the KEYPAD ENTER button to confirm, otherwise 36000A series will not save the changes the settings.

Note: Pass: Automatic test mode, no NG state, is the PASS.

Fail: Automatic test mode, any test if the NG then is the FAIL.

3.5.1.5. 36000A Series Master/Slave Instructions

36000A Series "MASTER / SLAVE" Parallel function, 1 Master, 7 SLAVE, Setting Method Press the System key to set the CONTROL MODE to select ALONE, MASTER or SLAVE1 ~ 7, Press the ENTER key to set, when Power off Data will Not be lost, this parameter is saved. Master will automatically detect whether there is Slave machine, if there is no Slave Machine will run "ALONE Mode", if the Slave Machine will run "MASTER Mode".

Master machine measuring current and power meter is to show the total current and Total power (Master + Slave), the voltage meter is displayed by the Master Machine, The Slave machine voltage meter position will display "SL1" ~ "SL7".

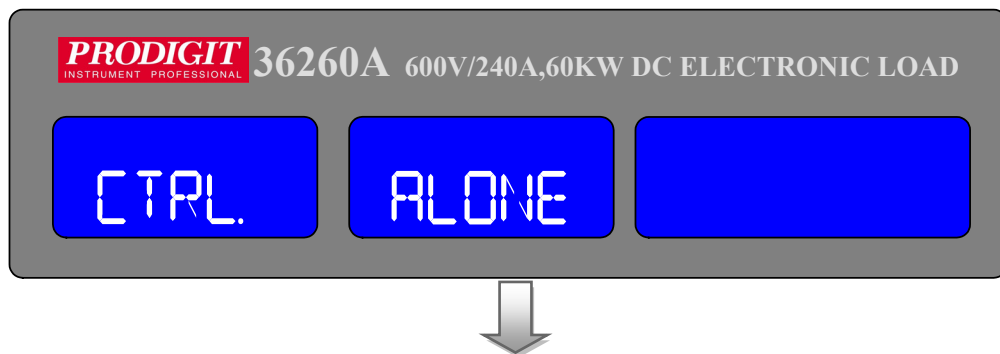

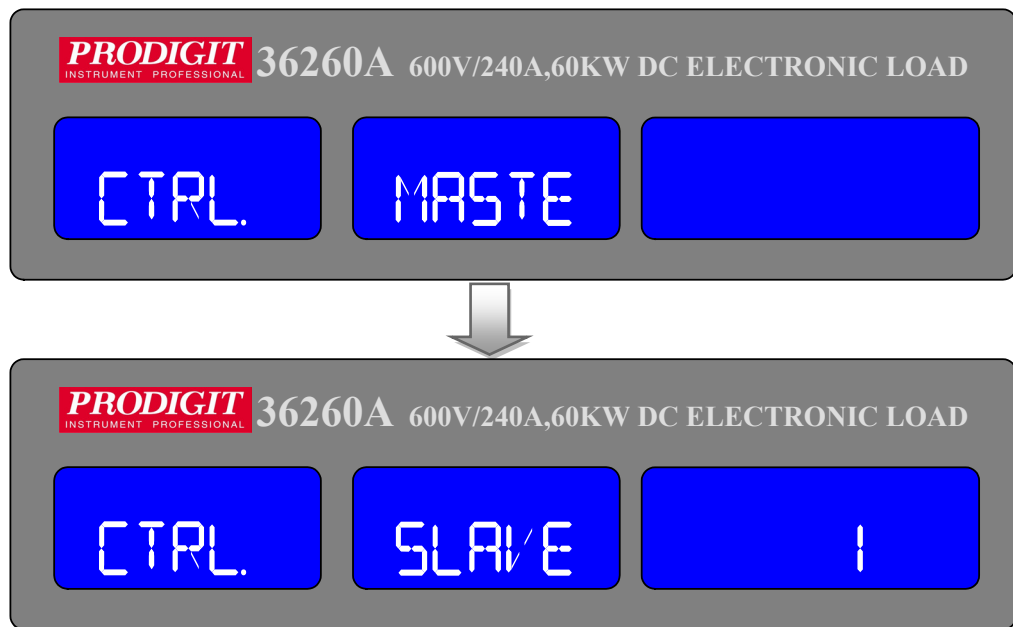

3.5.1.6. The following procedure should be followed before applying power on

Master/Slave mains:

- Step1. Turn on (O) the Slave POWER switch.
- Step2. Turn on (O) the Master POWER switch.

3.5.1.7. The following procedure should be followed before applying power off

Master/Slave mains:

- Step1. Turn off (I) the Master POWER switch.
- Step2. Turn off (I) the Slave POWER switch.

3.5.1.8. Parallel method:

Use HD-DSUB 15pin 1: 1 Cable to connect the MASTER and SLAVE Rear Panel, HD-DSUB 15pin connector (connect the upper and lower Connectors),

Caution: Do not use VGA Cable, because of internal pin4 ~ 8, 11 and Chassis short circuit.

MASTER / SLAVE
CONTROL

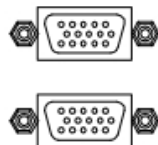

3.5.1.9. Wiring requirements: Master/Slave, It requires wiring as follows:

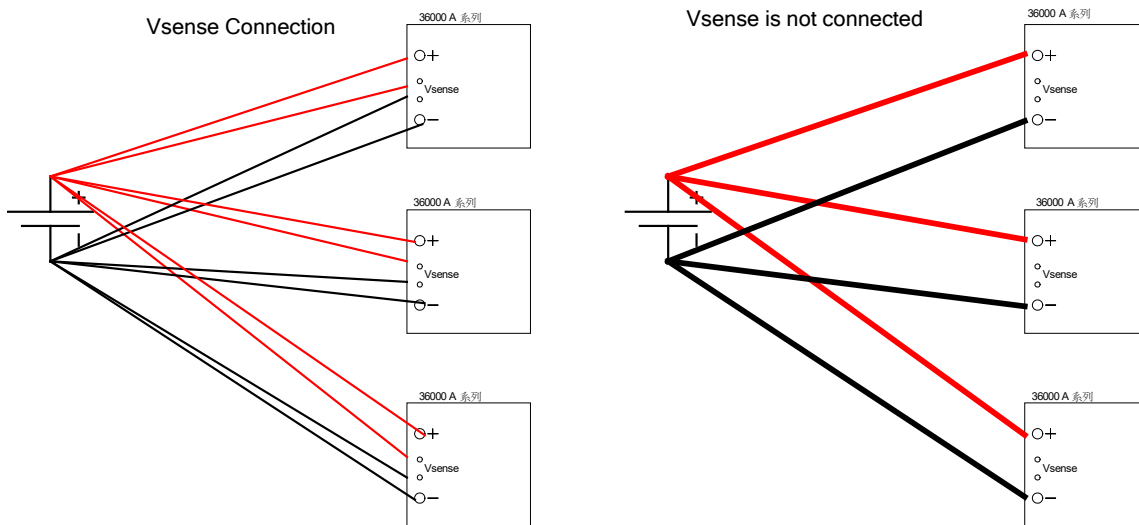

3.5.1.10. Manual operation :

(36260A MASTER/SLAVE model the following is example)

PRESET setting : CC/CR/CV/CP Mode as Figure , CC setting 100A=Master 50A + Slave 50A , CR:2250Ω=Master//Slave=4500Ω//4500Ω, CV: 100V=Master 100V= Slave=100V , CP:1000W=Master 500W + Slave 500W.

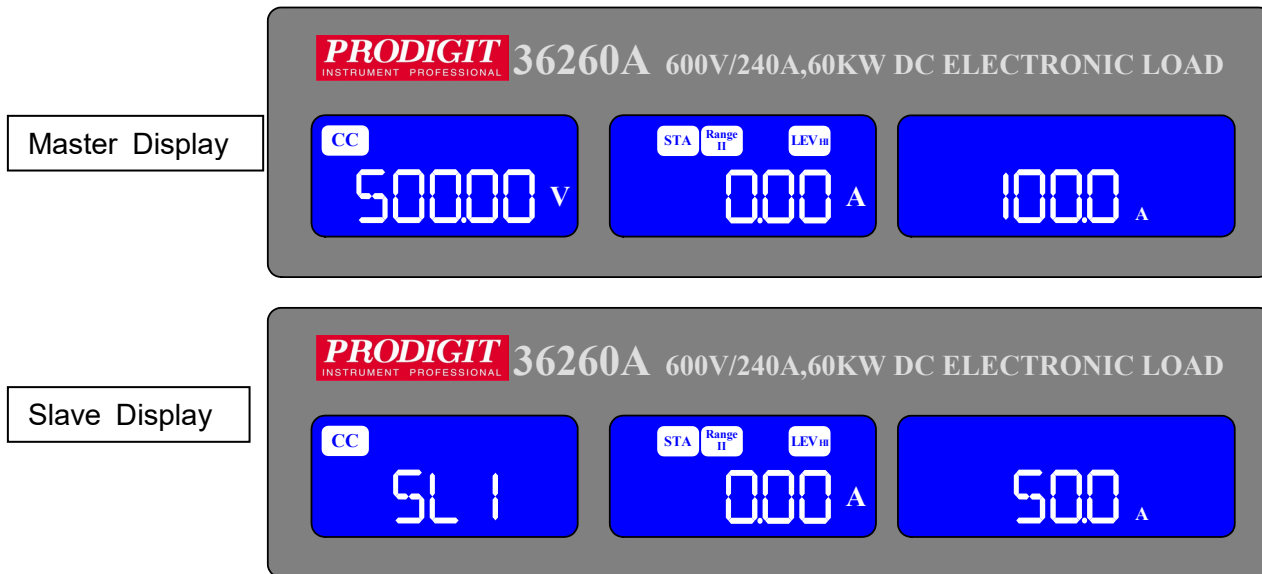

Figure CC Set 100A

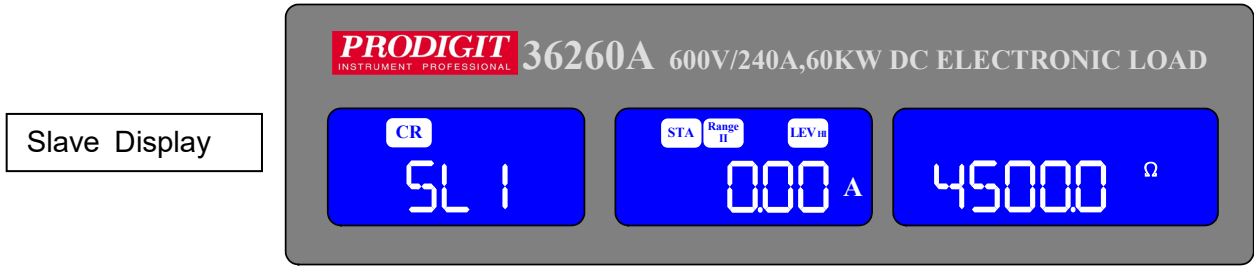
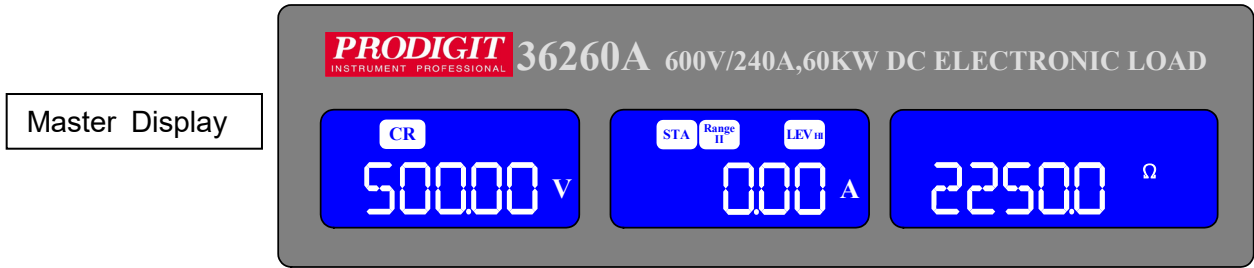

Figure CR Set 2250Ω

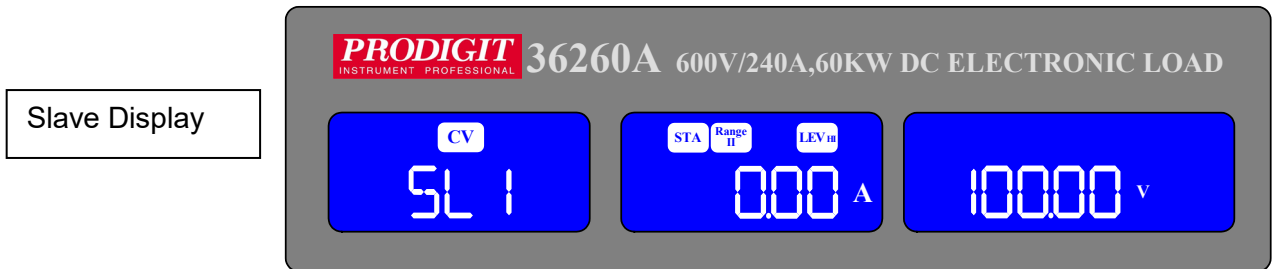
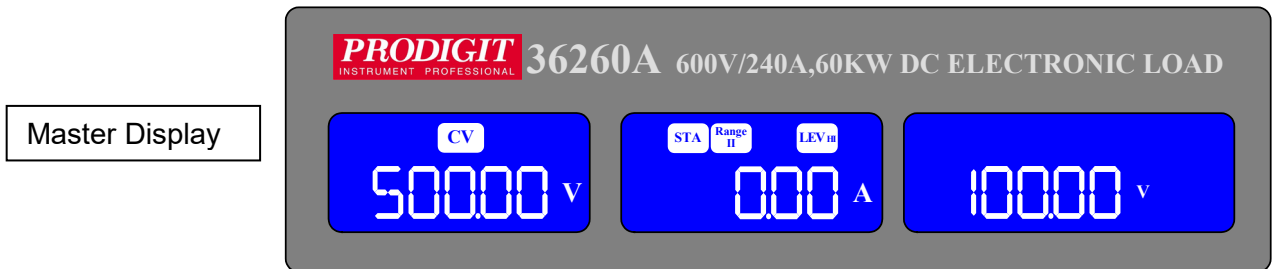
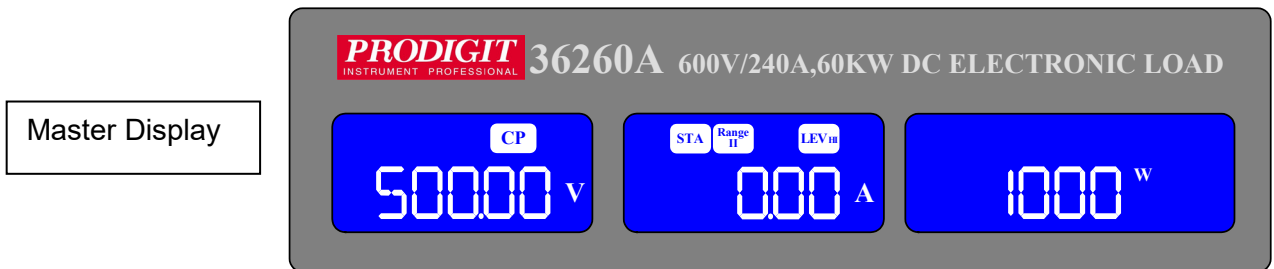

Figure CV Set 100V



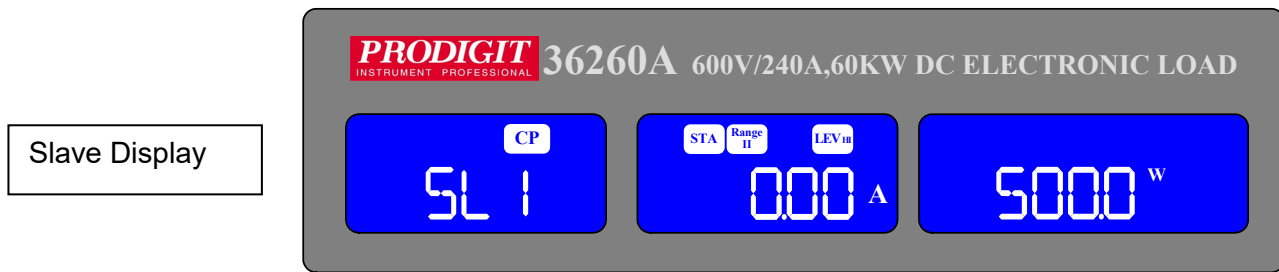

Figure CP Set 1000W

3.5.1.11. Master Mode operation except CC / CR / CV / CP MODE, The following functions Will be disable.

- Config function BATT type 1~N Disable
- Config functions MPPT disable.
- CV+Current limit, CV+Power limit Disable.
- Recall/Store Disable.
- Auto Seq. Disable.
- Short, OCP, OPP Disable.
- External I/O Disable

3.5.1.12. REMOTE operating : Master Mode can use the command as follows

SETTING PRESET NUMERIC COMMAND	REMARK
MODE {SP} {CC CR CV CP} {; NL}	
RISE{SP} {NR2} {; NL}	A/us
FALL{SP} {NR2} {; NL}	A/us
PERD: {HIGH LOW} {SP} {NR2} {; NL}	ms
LDONV{SP} {NR2} {; NL}	
LDOFFV{SP} {NR2} {; NL}	
CC CURR : {HIGH LOW} {SP} {NR2}{; NL}	
CP: {HIGH LOW} {SP} {NR2}{; NL}	
CR RES : {HIGH LOW} {SP} {NR2}{; NL}	
CV VOLT : {HIGH LOW} {SP} {NR2}{; NL}	
SENS {SP} {ON OFF AUTO 1 0} {; NL}	0: OFF/AUTO, 1:ON
LEV {SP} {LOW HIGH 0 1} {; NL}	
DYN {SP} {ON OFF 1 0} {; NL}	
LOAD {SP}{ON OFF 1 0} {; NL}	
MEAS: CURR {?}{; NL}	
MEAS: VOLT {?}{; NL}	
MEAS:POW {?}{; NL}	
REMOTE {; NL}	RS232/USB/LAN command
LOCAL{; NL}	RS232/USB/LAN command

3.5.2. The function keys on the front panel of 36000A series mainframe are designed for high Testing throughput purpose. There are 150 operation states or testing steps can be Store in the EEPROM memory of 36000A series electronic load Respectively, each State can store or recall the load status and level for Electronic load simultaneously.

	36XXXA
STATE	150

3.5.2.1. STORE process:

- Set the load status and load level.
- Press SHIFT key then press the STORE key to enter the storage state.
- Press UP, DOWN key or KEYPAD to adjust, press the ENTER OK to Save the STATE.

3.5.2.2. RECALL operation:

- Press RECALL to enter the call state.
- Press UP, DOWN key or KEYPAD to adjust.
- Finally, Press the ENTER key to confirm, In the electronic load front Panel, set the value that would call out the information in accordance With re-Setting.

3.5.3. AUTO SEQUENCE instructions

36000A series has AUTO SEQUENCE function, 36000A series to select the State F1~F9 automatic testing can be edited, 16 steps each group can be set to Select 150 Group of the STATE, within each step can be set TEST TIME Units Of 100 ms range (0.1s ~ 9.9s).

3.5.3.1. EDIT MODE

- Press SHIFT key, press the SEQ. key to enter the AUTO SEQUENCE Mode, Press UP, DOWN key to select EDIT, the LCD display shows “EDIT” on left 5 Digit LCD display, Middle 5 digit LCD display “FX”, “FX” means to select the State F1-F9, Press keypad key 1 ~ 9 choose F1 ~ F9.

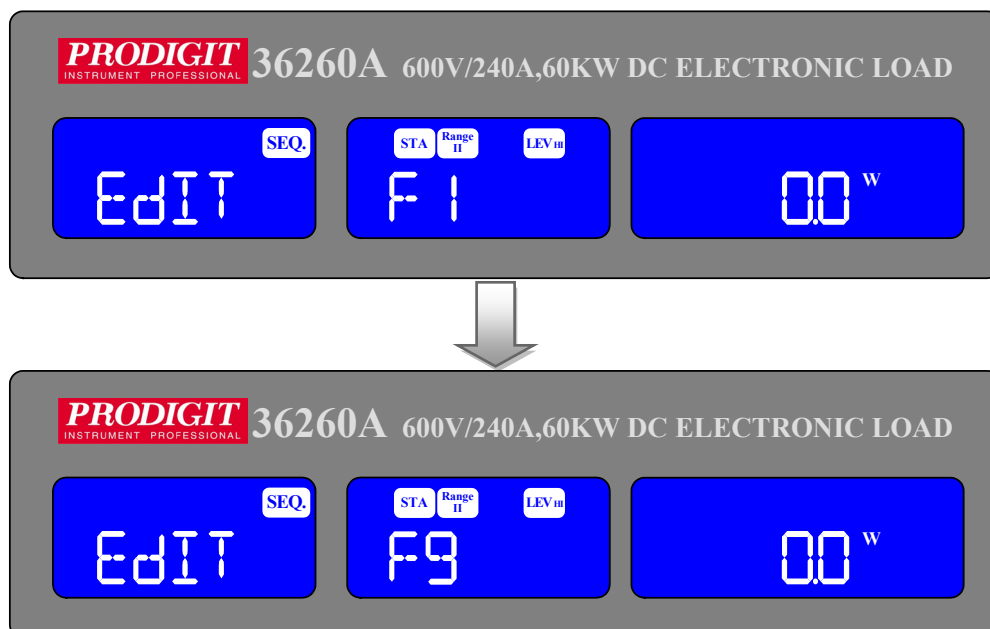

- Press ENTER key, the LCD display shows “FX-XX” on left 5 digit LCD display, Middle 5 digit LCD display ”STATE” , right 5 digit LCD display setting 1~150, “FX” means to select the state F1-F9. “XX” means the test STEP01-16, setting State value, press UP and down Key or keypad to adjust setting.

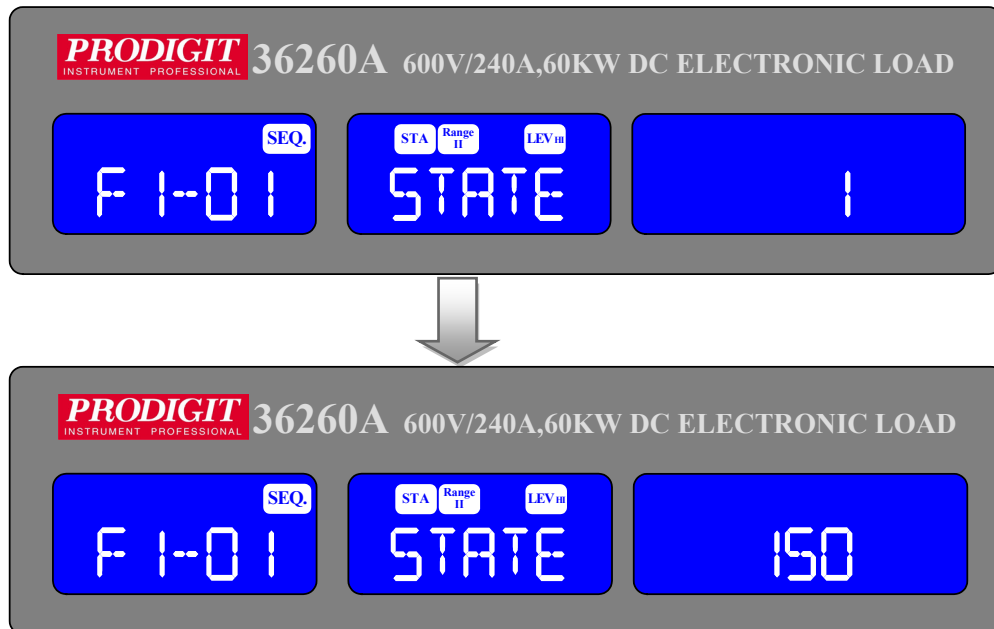

- Test time setting:
Press ENTER to set TIME value, press UP, DOWN keys or KEYPAD to adjust Settings, range from 100 ms~9999ms.
Press ENTER key or SAVE key to finish editing the action is set to REPEAT, If you do not save the settings, press the EXIT key to leave edit mode.

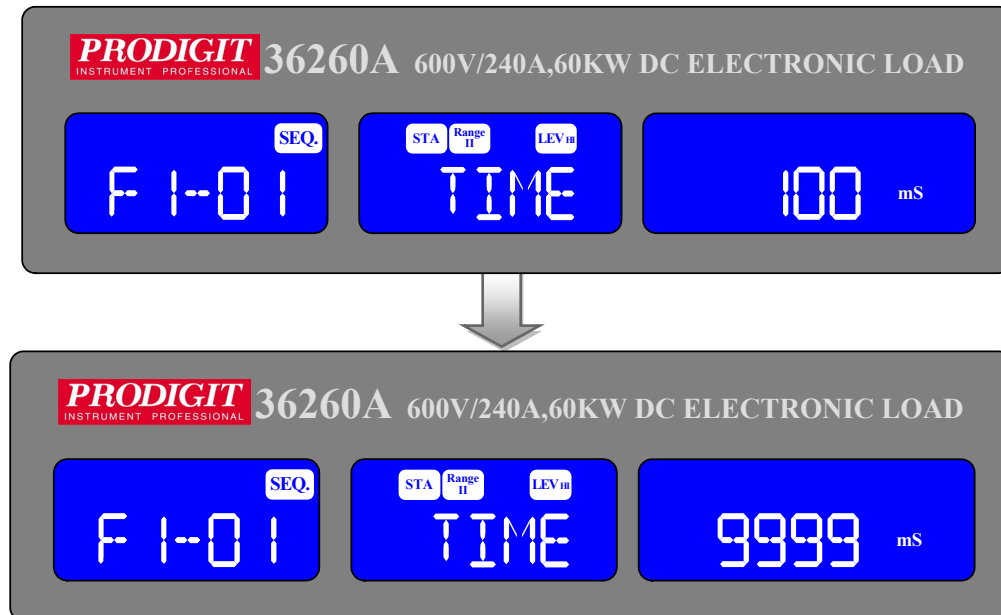

3.5.3.2. TEST MODE

Press SHIFT key, press the SEQ. key to enter the AUTO SEQUENCE Mode, Press UP, DOWN key to select TEST, the LCD display shows "TEST" on left 5 Digit LCD display, Middle 5 digit LCD display "FX", "FX" means to Select the State F1-F9, Press keypad key 1 ~ 9 choose F1 ~ F9.

When the press ENTER to enter. The next automatic test Mode.

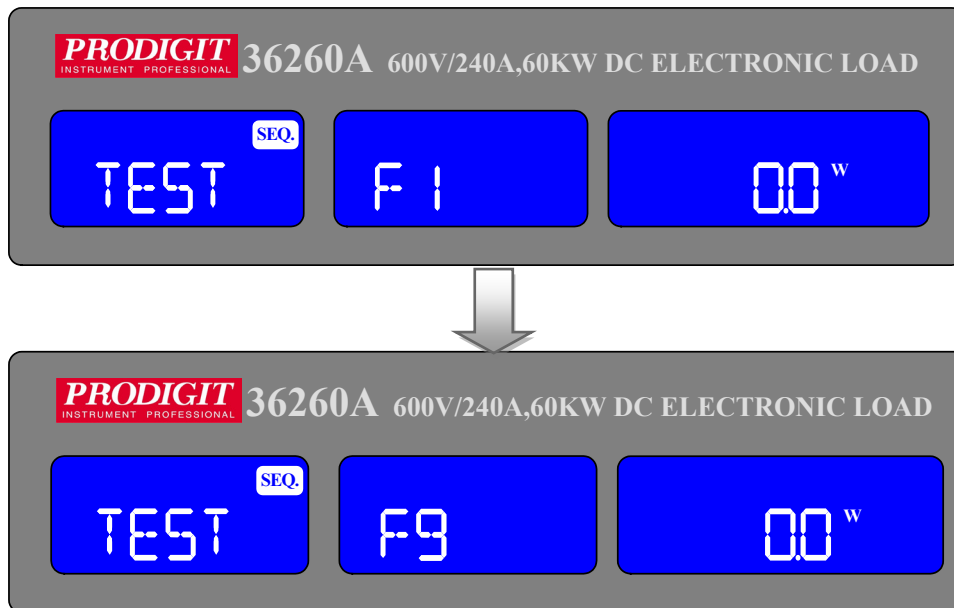

Test LCD will display "SXX", "XX" on behalf of the test of STEP, if the test Result is NG; the LCD will show "NG" (flashing) and suspension of the test, this time users can test or ENTER key to continue Press EXIT key to leave the test mode, test mode by the (STEP01 - TIME) then (SETP02 - TIME) until all the Steps done or press EXIT to leave the test mode.

If all the test steps are OK, the test result is PASS, LCD displays "PASS"; Test procedure if any of the NG, the test result is FAIL; LCD displays "FAIL", If the buzzer is set to ON, when the test result is PASS automatically when The buzzer will call out, if the test result is FAIL Buzzer will sound when the Second call.

When the test is completed, the user can press the ENTER key again to test or EXIT key to leave the test mode.

Example 1: Edit the 16 step test is completed, press the TEST key, according to the order of S01 ~ S16 test is complete LCD display PASS.

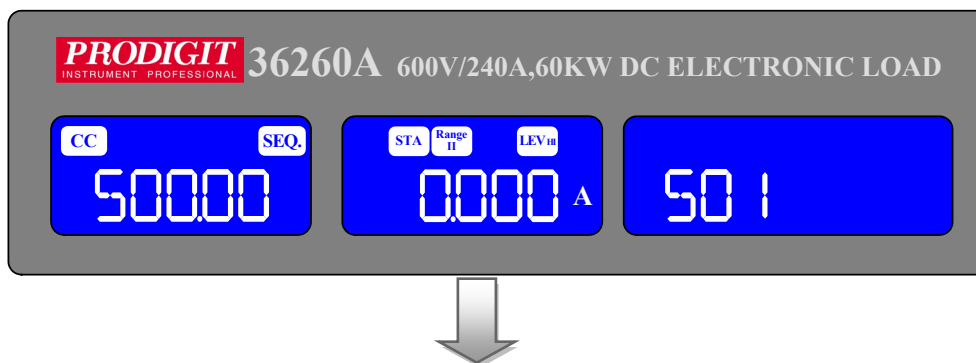

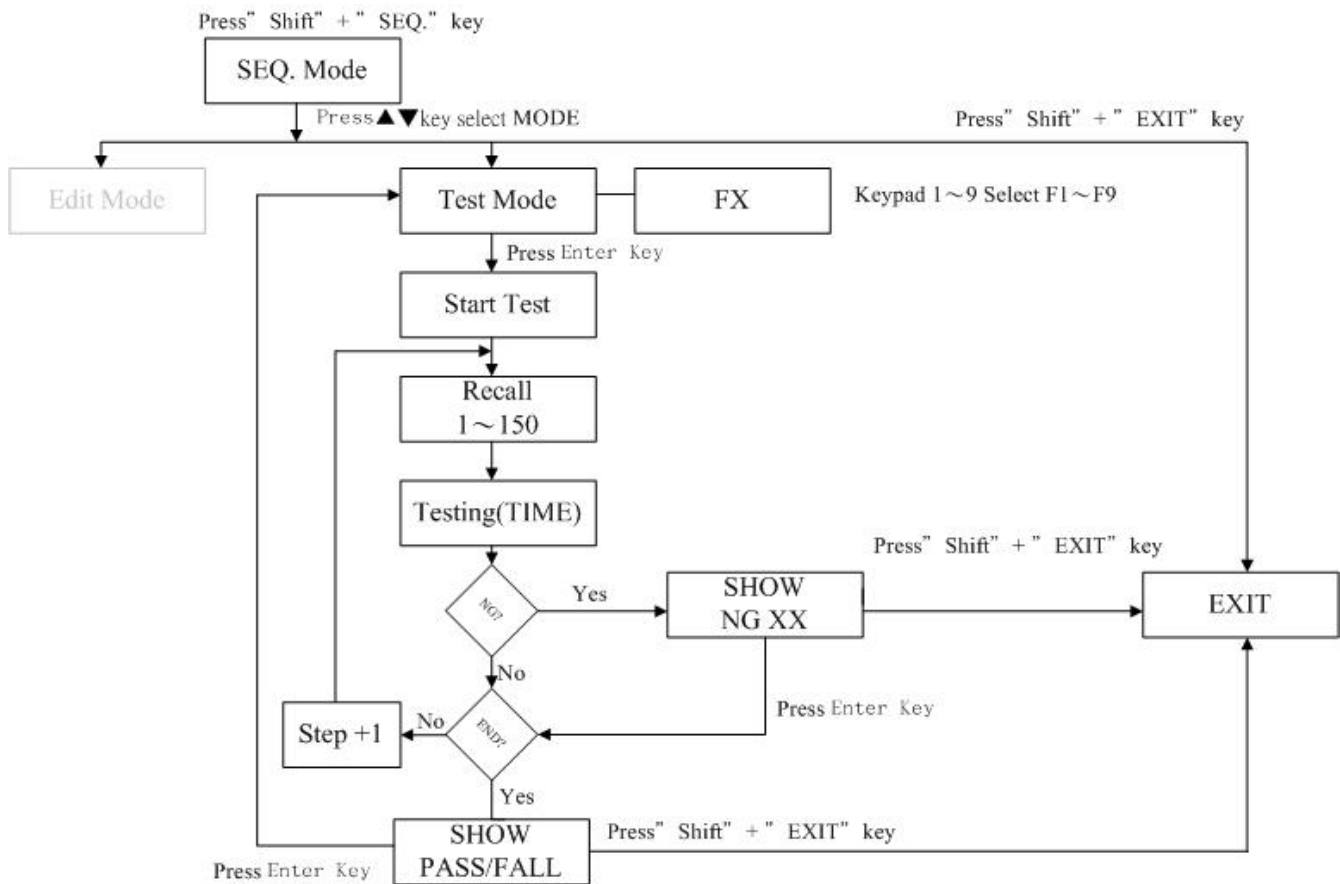
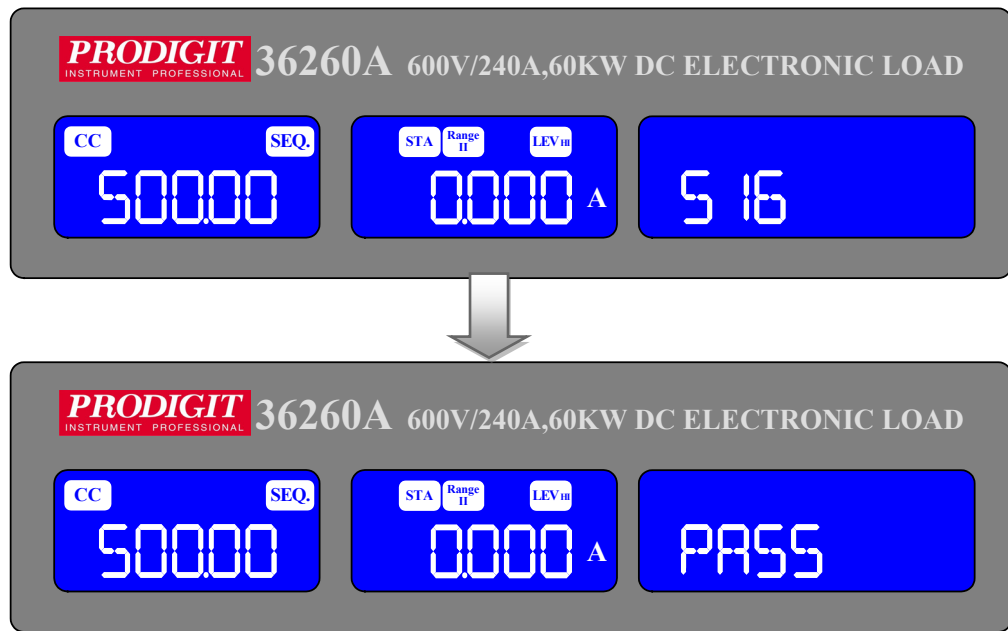

Fig 3-10 TEST MODE OPERATION FLOW-CHA

3-6. Initial setting of 36000A series load

The following tables detail the initial settings of the 36000A series of Load when Shipped from the factory.

Item		Initial value	Item	Initial value	
CC L+Preset		0.000 A	LIMIT	V_Hi	600.00 V
CC H+Preset		0.000 A		V_Lo	0.00 V
CR H+Preset		8571 Ω		I_Hi	210.0 A
CR L+Preset		8571 Ω		I_Lo	0.00 A
CV H+Preset		600.00 V		W_Hi	50000 W
CV L+Preset		600.00 V		W_Lo	0.0 W
CP L+Preset		0.00 W	CONFIG	SENSE	Auto
CP H+Preset		0.00 W		LD-ON	4.000 V
DYN	T HI	0.010 mS		LD-OFF	0.500 V
	T LO	0.010 mS		POLAR	+LOAD
	RISE	0.168A/uS	SHORT		Disable
	FALL	0.168A/uS	OPP		Disable
			OCP		Disable

Table 3-2 36250A initialize

Item		Initial value	Item	Initial value	
CC L+Preset		0.000 A	LIMIT	V_Hi	600.00 V
CC H+Preset		0.000 A		V_Lo	0.00 V
CR H+Preset		7500 Ω		I_Hi	240.0 A
CR L+Preset		7500 Ω		I_Lo	0.00 A
CV H+Preset		600.00 V		W_Hi	60000 W
CV L+Preset		600.00 V		W_Lo	0.0 W
CP L+Preset		0.00 W	CONFIG	SENSE	Auto
CP H+Preset		0.00 W		LD-ON	4.000 V
DYN	T HI	0.010 mS		LD-OFF	0.500 V
	T LO	0.010 mS		POLAR	+LOAD
	RISE	0.192A/uS	SHORT		Disable
	FALL	0.192A/uS	OPP		Disable
			OCP		Disable

Table 3-3 36260A initialize

Item		Initial value	Item	Initial value	
CC L+Preset		0.000 A	LIMIT	V_Hi	1000.0 V
CC H+Preset		0.000 A		V_Lo	0.00 V
CR H+Preset		2500 Ω		I_Hi	500.0 A
CR L+Preset		2500 Ω		I_Lo	0.00 A
CV H+Preset		1000.0 V		W_Hi	50000 W
CV L+Preset		1000.0 V		W_Lo	0.0 W
CP L+Preset		0.00 W	CONFIG	SENSE	Auto
CP H+Preset		0.00 W		LD-ON	10.40 V
DYN	T HI	0.010 mS		LD-OFF	9.60 V
	T LO	0.010 mS	POLAR	+LOAD	
	RISE	0.04A/uS	SHORT	Disable	
	FALL	0.04A/uS	OPP	Disable	
			OCP	Disable	

Table 3-4 36350A initialize

Item		Initial value	Item	Initial value	
CC L+Preset		0.000 A	LIMIT	V_Hi	1000.0 V
CC H+Preset		0.000 A		V_Lo	0.00 V
CR H+Preset		2000 Ω		I_Hi	600.0 A
CR L+Preset		2000 Ω		I_Lo	0.00 A
CV H+Preset		1000.0 V		W_Hi	60000 W
CV L+Preset		1000.0 V		W_Lo	0.0 W
CP L+Preset		0.00 W	CONFIG	SENSE	Auto
CP H+Preset		0.00 W		LD-ON	10.40 V
DYN	T HI	0.010 mS		LD-OFF	9.60 V
	T LO	0.010 mS	POLAR	+LOAD	
	RISE	0.048A/uS	SHORT	Disable	
	FALL	0.048A/uS	OPP	Disable	
			OCP	Disable	

Table 3-5 36360A initialize

3-7. Protection features

The protection features of the 36000A series Electronic load modules are as follows:

- 3.7.1. **Overvoltage protection:** The Electronic Load input will turn OFF if the overvoltage circuit is tripped. The message OVP will be displayed on the LCD. When the OVP fault has been removed the load can be set to sink power again. While the unit will attempt to protect itself given an OVP state it is strongly advised to guard against any potential OVP fault state by using external protection and the correctly rated electronic load.

The Overvoltage protection circuit is set at a predetermined voltage and cannot be adjusted. The OVP level is 105% of the 36000A Series nominal voltage rating.

CAUTION: Never apply an AC voltage to the input of the 36000A series Load. Do not apply a DC voltage that is higher than 36000A series Load rating. If this advice is ignored it is likely that damage will be caused to the electronic load module. This damage will not be covered by the warranty.

- 3.7.2. Over current protection (OCP): The OCP protection will engage if the current being taken by the load reaches 105% of the load module's maximum current. The message OCP will be displayed on the front panel and the unit will switch to its LOAD OFF state. Once the source of the over current has been removed the load can be switched on again.
- 3.7.3. Over power protection (OPP): The 36000A series Electronic Load monitors the power dissipation level. The input to the load is automatically switched to LOAD OFF if the power dissipation is greater than 105% of the rated power input. If an over power condition occurs the display will show OPP
- 3.7.4. Over temperature protection (OTP): The load internal temperature at the heat sink is monitored. If the temperature reaches approximately 100°C the OTP message will be displayed and the unit will automatically switch to the LOAD OFF state. If an OTP error occurs please check the ambient temperature is between 0 to 40°C. Also ensure that the front and rear air vents of the mainframe are not obstructed. The air flow is taken from the front of the mainframe and exhausted from the rear. Therefore a suitable gap needs to be left at the rear of the mainframe. A minimum of 15cm is recommended. After a suitable cooling period the load can be switched.
- 3.7.5. Reverse Polarity: The 36000A series load module will tolerate a reverse current up to the maximum current rating of the load module. The '-' symbol will be shown on the voltage and current displays.

Please note that damage will occur if the reverse current is higher than the load module's maximum rating. If a reverse current is noticed turn off and disconnect the dc power source and turn the load off. The connections between the DC Source and the Load Module can now be correctly made.



If a reverse polarity situation occurs the load will sink power even if the LOAD button is OFF. No current will be displayed on the 36000A series load module. Current up to the load's maximum current rating will be tolerated in reverse polarity. However there is no OVP OCP and OPP protection. It is strongly recommended that the load lines be fused if it is likely that the load could be subject to reverse polarity. These fuses should be fast acting and rated at the maximum current of the load module +5%.

Chapter 4 Communication Interface programming operation

4-1. Introduction

The rear panel remote control interface of 36000A Series mainframe is designed to connect PC or NOTEBOOK PC with remote control interface, the NOTEBOOK PC acts as a remote controller of 36000A Series Electronic Load.

This feature can be used as an automatic load/cross load regulation and centering voltage testing for a switching power supply or an rechargeable battery charge/discharge characteristic testing. The function capability of rear panel remote control interface not only can set the load level and load status, but also can read back the load voltage and load current.

NOTE: When use USB/LAN interface controls the 36000A Series, the 36000A Series will convert the USB/LAN interface to RS232 interface.

4-2. The summary of RS232 Interface and command

The following RS232 commands are same as GPIB commands. The RS232 protocol in 36000A Series mainframe is listing below:

Baud-rate	: 9600~115200bps
Parity	: None
Data bit	: 8 bits
Stop bit	: 1 bit
Handshaking	: Hardware (RTS/CTS).

The RS232 Interface connector of 36000A Series rear panel, RS232 is shown in Fig4-1.

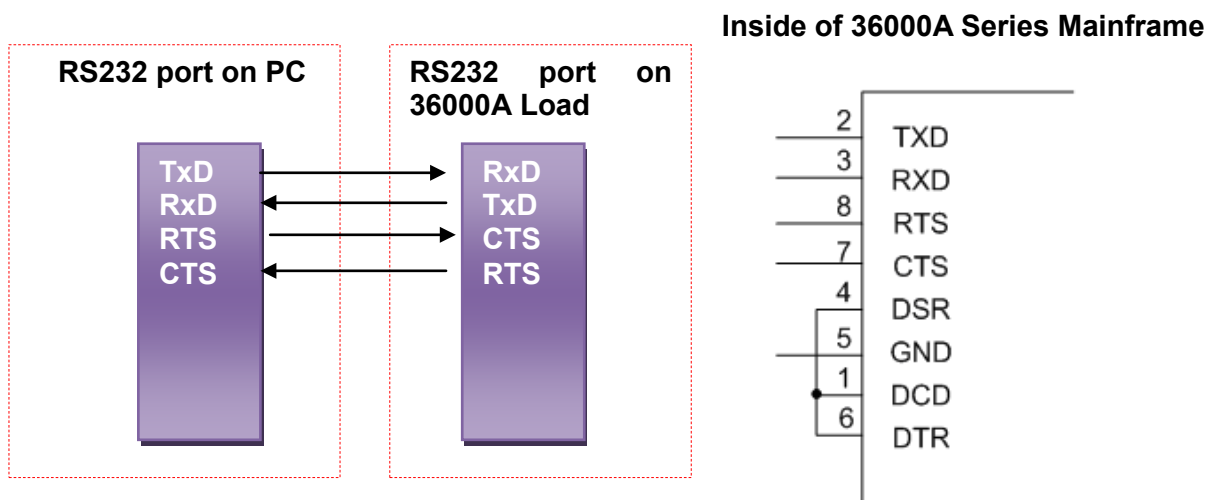

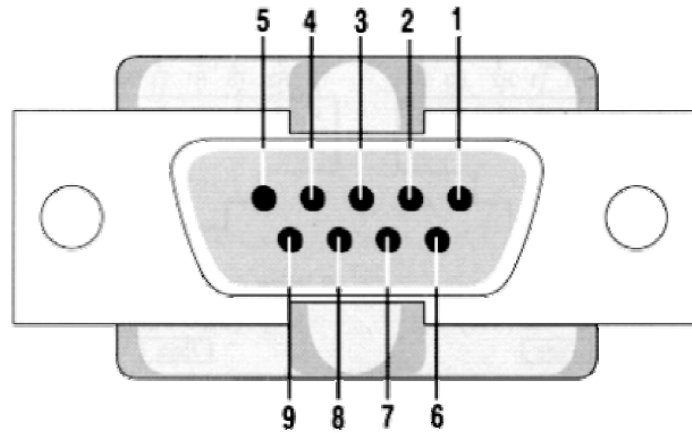

PIN	Abbreviation	Description
Pin1	CD	Carrier Detect
Pin2	RXD	Receive
Pin3	TXD	Transmit
Pin4	DTR	Data Terminal Ready
Pin5	GND	Ground
Pin6	DSR	Data Set Ready
Pin7	RTS	Request To Send
Pin8	CTS	Clear To Send
Pin9	RI	Ring Indicator

Fig 4-1 RS232 INTERFACE CONNECTION OF REAR PANEL

4-3. 36000A Series Communication Interface programming command List1 SIMPLE TYPE FORMAT

SETTING PRESET NUMERIC COMMAND	MODEL	REMARK
	36XXXA	
RISE{SP} {NR2} {; NL}	V	A/us
FALL{SP} {; NL}	V	A/us
PERD:{HIGH LOW} {SP} {NR2} {; NL}	V	
LDONV{SP} {NR2} {; NL}	V	
LDOFFV{SP} {NR2} {; NL}	V	
CC CURR:{HIGH LOW} {SP} {NR2}{; NL}	V	
CP:{HIGH LOW} {SP} {NR2}{; NL}	V	
CR RES:{HIGH LOW} {SP} {NR2}{; NL}	V	
CV VOLT:{HIGH LOW} {SP} {NR2}{; NL}	V	
TCONFIG{SP} {NORMAL OCP OPP SHORT}{; NL}	V	
OCP:START {SP} {NR2}{; NL}	V	
OCP:STEP {SP} {NR2}{; NL}	V	
OCP:STOP {SP} {NR2}{; NL}	V	
VTH {SP} {NR2}{; NL}	V	
OPP:START {SP} {NR2}{; NL}	V	
OPP:STEP {SP} {NR2}{; NL}	V	
OPP:STOP {SP} {NR2}{; NL}	V	
STIME {SP} {NR2}{; NL}	V	
BATT:TYPE {SP}{n}{; NL}	V	n=1~5
BATT:UVP{SP}{NR2}{; NL}	V	unit:V
BATT:TIME{SP}{n}{; NL}	V	n= 1~99999sec
BATT:STEP{SP}{n}{; NL}	V	TYPE4: n=1~3,TYPE5:n=1~9
BATT:CCH{n}{SP}{NR2}{; NL}	V	TYPE4 CC:HIGH level, n=1~3
BATT:CCL{n}{SP}{NR2}{; NL}	V	TYPE4 CC:LOW level, n=1~3
BATT:TH{n}{SP}{NR2}{; NL}	V	TYPE4 Thigh(unit:ms), n=1~3
BATT:TL{n}{SP}{NR2}{; NL}	V	TYPE4 Tlow(unit:ms), n=1~3
BATT:CYCLE{n}{SP}{NR1}{; NL}	V	TYPE4 Cycle:1~2000, n=1~3
BATT:CC{n}{SP}{NR2}{; NL}	V	TYPE5 Current, n=0~9
BATT:DTIME{n}{SP}{NR1}{; NL}	V	TYPE5 Delta time(T1~T9:0~6000sec), n=0~9
BATT:REPEAT {SP} {n}{; NL}	V	TYPE4&5 Repeat times:0~9999
CPRSP{SP}{n}{; NL}	V	

Table 4-1 REMOTE CONTROL SETTING COMMAND SUMMARY

QUERY PRESET NUMERIC COMMAND	MODEL	RETURN
	36XXXXA	
RISE{?} {; NL}	V	###.####
FALL{?} {; NL}	V	###.####
PERD:{HIGH LOW}{?} {; NL}	V	###.####
LDOINV{?}{; NL}	V	###.####
LDOFFV{?}{; NL}	V	###.####
CC CURR: {HIGH LOW} {?} {; NL}	V	###.####
CP: {HIGH LOW} {?} {; NL}	V	###.####
CR RES : {HIGH LOW} {?} {; NL}	V	###.####
CV VOLT: {HIGH LOW} {?} {; NL}	V	###.####
TCONFIG {?}{; NL}	V	1:NORMAL 3:OPP 2:OCP 4:SHORT
OCP: START {?} {; NL}	V	###.####
OCP: STEP {?}{; NL}	V	###.####
OCP: STOP {?}{; NL}	V	###.####
VTH {?}{; NL}	V	###.####
OPP: START {?} {; NL}	V	###.####
OPP: STEP {?}{; NL}	V	###.####
OPP: STOP {?}{; NL}	V	###.####
STIME {?}{; NL}	V	###.####
OCP {?}{; NL}	V	###.####
OPP {?}{; NL}	V	###.####

Table 4-2 REMOTE CONTROL QUERY COMMAND SUMMARY

LIMIT COMMAND	MODEL	REMARK
	36XXXXA	
IH IL{SP}{NR2}{; NL}	V	
IH IL {?}{; NL}	V	
WH WL{SP}{NR2}{; NL}	V	
WH WL {?}{; NL}	V	###.####
VH VL{SP}{NR2}{; NL}	V	
VH VL {?}{; NL}	V	###.####
SVH SVL{SP}{NR2}{; NL}	V	
SVH SVL {?}{; NL}	V	###.####
ADDCV:VOLTage{SP}{NR2}{; NL}	V	
ADDCV:VOLTage {?}{; NL}	V	###.####
ADDCV{SP}{ON OFF}{; NL}	V	

Table 4-3 REMOTE CONTROL LIMIT COMMAND SUMMARY

STAGE COMMAND	MODEL	REMARK
	36XXXA	
LOAD {SP}{ON OFF 1 0}{; NL}	V	
LOAD {?}{; NL}	V	0:OFF 1:ON
MODE {SP}{CC CR CV CP}{; NL}	V	
MODE {?}{; NL}	V	0:CC 1:CR 2:CV 3:CP
SHOR {SP}{ON OFF 1 0}{; NL}	V	
SHOR {?}{; NL}	V	0:OFF 1:ON
PRES {SP}{ON OFF 1 0}{; NL}	V	
PRES {?}{; NL}	V	0:OFF 1:ON
SENS {SP}{ON OFF AUTO 1 0}{; NL}	V	
SENS {?}{; NL}	V	0:OFF/AUTO 1:ON
LEV {SP}{LOW HIGH 0 1}{; NL}	V	
LEV {?}{; NL}	V	0:LOW 1:HIGH
DYN {SP}{ON OFF 1 0}{; NL}	V	
DYN {?}{; NL}	V	0:OFF 1:ON
CLR{; NL}	V	
ERR {?}{; NL}	V	
NG {?}{; NL}	V	0:GO 1:NG
PROT {?}{; NL}	V	
CCR{SP}{AUTO R2}{; NL}	V	
NGENABLE{SP}{ON OFF}{; NL}	V	
POLAR{SP}{POS NEG}{; NL}	V	
START{; NL}	V	
STOP{; NL}	V	
TESTING {?}{; NL}	V	0:TEST END, 1:TESTING
MPP{?}{; NL}	V	

Table 4-4 STAGE COMMAND SUMMARY

System command :

COMMAND	NOTE	RETURN
RECALL {SP} {m}{; NL}	m=1~150 m:STATE	
STORE {SP} {m}{; NL}	m=1~150 m:STATE	
REMOTE {; NL}	RS232/USB/LAN command	
LOCAL{; NL}	RS232/USB/LAN command	
NAME {?} {; NL}		"XXXXXX"

Table 4-5 SYSTEM COMMAND SUMMARY

Measure command

COMMAND	36XXXXA	RETURN
MEAS: CURR {?}{; NL}	V	###.####
MEAS: VOLT {?}{; NL}	V	###.####
MEAS: POW {?}{; NL}	V	###.####

Table 4-6 MEASURE COMMAND SUMMARY

REMARK:

1. Current engineering unit: A
2. Voltage engineering unit: V
3. Resistance engineering unit: Ω
4. Period engineering unit: mS
5. Slew-rate engineering unit: A/uS
6. Power engineering unit: W

AUTO SEQUENCE:

AUTO SEQUENCE SET COMMAND	NOTE	RETURN
FILE {SP} {n}{; NL}	n=1~9	1~9
STEP {SP} {n}{; NL}	n=1~16	1~16
TOTSTEP {SP} {n}{; NL}	Total step n=1~16	1~16
SB {SP} {m}{; NL}	m=1~150 m:STATE	
T1 {SP} {NR2}{; NL}	0.1~9.9(s)	0.1~9.9(sec)
T2 {SP} {NR2}{; NL}	0.0~9.9(s)	0.0~9.9(sec)
SAVE {; NL}	Save "File n" data	
REPEAT {SP} {n}{; NL}	n=0~9999	0~9999
RUN {SP} {F} {n}{; NL}	N=1~9	AUTO REPLY "PASS" or "FAIL:XX" (XX=NG STEP)

Table 4-7 Auto sequence command list

BATTERY TEST SET COMMAND

COMMAND	MODEL	REMARK
	36XXXA	
BATT:TYPE {SP}{n}{; NL}	V	n=1~5
BATT:UVP{SP}{NR2}{; NL}	V	unit:V
BATT:TIME{SP}{NR1}{; NL}	V	TIME= 1~999999sec
BATT:STEP{SP} {n}{; NL}	V	TYPE4:n=1~3,TYPE5:n=1~9
BATT:CCH{n}{SP} {NR2}{; NL}	V	TYPE4 CC:HIGH level, n=1~3
BATT:CCL{n}{SP} {NR2}{; NL}	V	TYPE4 CC:LOW level, n=1~3
BATT:TH{n}{SP} {NR2}{; NL}	V	TYPE4 Thigh(unit:ms), n=1~3
BATT:TL{n}{SP} {NR2}{; NL}	V	TYPE4 Tlow(unit:ms), n=1~3
BATT:CYCLE{n}{SP} {NR1}{; NL}	V	TYPE4 Cycle:1~2000, n=1~3
BATT:CC{n}{SP} {NR2}{; NL}	V	TYPE5 Current, n=0~9
BATT:DTIME{n}{SP} {NR2}{; NL}	V	TYPE5 Delta time(T1~T9:0~6000sec), n=0~9
BATT:REPEAT {SP} {NR1}{; NL}	V	TYPE4&5 Repeat times:0~9999
BATT:TEST {SP} {ON OFF}{; NL}	V	ON:START TEST,OFF:STOP TEST TYPE1&2 TEST END,AUTO ECHO "OK,XXXXX" XXXXX:AH TYPE3~5 TEST END,AUTO ECHO "OK,XXXXX" XXXXX:DVM

Table 4-8 BATTERY TEST SET COMMAND

4-4. 36000A Series Communication Interface programming command list 2 COMPLEX TYPE FORMAT

SETTING COMMAND SUMMARY	MODEL	REMARK
	36XXXXA	
[PRESet:] RISE{SP} {NR2} {; NL}	V	A/us
[PRESet:] FALL{SP} {; NL}	V	A/us
[PRESet:] PERI PERD:HIGH LOW {SP} {NR2} {; NL}	V	
[PRESet:] LDONv{SP} {NR2} {; NL}	V	
[PRESet:] LDOFv{SP} {NR2} {; NL}	V	
[PRESet:] CC CURR:{HIGH LOW} {SP} {NR2}{; NL}	V	
[PRESet:] CP:{HIGH LOW} {SP} {NR2}{; NL}	V	
[PRESet:] CR RES:{HIGH LOW} {SP} {NR2}{; NL}	V	
[PRESet:] CV VOLT:{HIGH LOW} {SP} {NR2}{; NL}	V	
[PRESet:] TCONFIG {SP} {NORMAL OCP OPP SHORT}{; NL}	V	
[PRESet:] OCP:START {SP} {NR2}{; NL}	V	
[PRESet:] OCP:STEP {SP} {NR2}{; NL}	V	
[PRESet:] OCP:STOP {SP} {NR2}{; NL}	V	
[PRESet:] VTH {SP} {NR2}{; NL}	V	
[PRESet:] OPP:START {SP} {NR2}{; NL}	V	
[PRESet:] OPP:STEP {SP} {NR2}{; NL}	V	
[PRESet:] OPP:STOP {SP} {NR2}{; NL}	V	
[PRESet:] STIME {SP} {NR2}{; NL}	V	
[PRESet:] MPPT {SP} {ON OFF}{; NL}	V	ON:START MPP TRACE
[PRESet:] MPPTIME {SP}n{; NL}	V	SET MPPT RECORD TIME n=1000~60000 mS
[PRESet:] CVIL {ON OFF}{; NL}	V	
[PRESet:] CVL:CURR{NR2}{; NL}	V	
[PRESet:] CVH:CURR{NR2}{; NL}	V	
[PRESet:] CPRSP{SP}{n}{; NL}	V	

Table 4-1B Communication Interface programming setting command summary

QUERY COMMAND SUMMARY	MODEL	RETURN
	36XXXA	
[PRESet:] RISE{?} {; NL}	V	###.####
[PRESet:] FALL{?} {; NL}	V	###.####
[PRESet:] PERI PERD : {HIGH LOW}{?} {; NL}	V	###.####
[PRESet:] LDONv {?}{; NL}	V	###.####
[PRESet:] LDOFv {?}{; NL}	V	###.####
[PRESet:] CC CURR : {HIGH LOW} {?} {; NL}	V	###.####
[PRESet:] CP: {HIGH LOW} {?} {; NL}	V	###.####
[PRESet:] CR RES: {HIGH LOW} {?} {; NL}	V	###.####
[PRESet:] CV VOLT: {HIGH LOW} {?} {; NL}	V	###.####
[PRESet:] TCONFIG {?}{; NL}	V	1:NORMAL 3:OPP 2:OCP 4:SHORT
[PRESet:] OCP: START {?} {; NL}	V	###.####
[PRESet:] OCP: STEP {?}{; NL}	V	###.####
[PRESet:] OCP: STOP {?}{; NL}	V	###.####
[PRESet:] VTH {?}{; NL}	V	###.####
[PRESet:] OPP: START {?} {; NL}	V	###.####
[PRESet:] OPP: STEP {?}{; NL}	V	###.####
[PRESet:] OPP: STOP {?}{; NL}	V	###.####
[PRESet:] STIME {?}{; NL}	V	###.####
[PRESet:] MPPT {?}{; NL}	V	READ MPP DATA "V/I/P" OR "END"
[PRESet:] MPPTIME {?}{; NL}	V	
[PRESet:] CPRSP{?}{; NL}	V	n=0~4,0: Fastest,4: slowest

Table 4-2B Communication Interface programming QUERY command summary

LIMIT	MODEL	RETURN
	36XXXA	
LIMit:CURRent:{HIGH LOW}{SP}{NR2}{: NL}	V	
LIMit:CURRent:{HIGH LOW }{?}{: NL}	V	###.####
IH IL{SP}{NR2}{: NL}	V	
IH IL {?}{: NL}	V	
LIMit:POWer:{HIGH LOW}{SP}{NR2}{: NL}	V	
LIMit:POWer:{HIGH LOW }{?}{: NL}	V	###.####
WH WL{SP}{NR2}{: NL}	V	
WH WL {?}{: NL}	V	####.###
LIMit:VOLTage:{HIGH LOW}{SP}{NR2}{: NL}	V	
LIMit:VOLTage:{HIGH LOW }{?}{: NL}	V	###.####
VH VL{SP}{NR2}{: NL}	V	
VH VL {?}{: NL}	V	###.####
SVH SVL{SP}{NR2}{: NL}	V	
SVH SVL {?}{: NL}	V	###.####
[LIMit:]ADDCV: VOLTage{SP}{NR2}{: NL}	V	
[LIMit:]ADDCV: VOLTage{?}{: NL}	V	###.####
[LIMit:]ADDCV{SP}{ON OFF}{: NL}	V	

Table 4-3B Communication Interface programming limit command summary

STAGE COMMAND	MODEL	REMARK
	36XXXA	
[STAtE:] LOAD {SP}{ON OFF} {; NL}	V	
[STAtE:] LOAD {?} {; NL}	V	0:OFF 1:ON
[STAtE:] MODE {SP} {CC CR CV CP}{; NL}	V	
[STAtE:] MODE {?} {; NL}	V	0 1 2 3:CC CR CV CP
[STAtE:] SHORt {SP} {ON OFF} {; NL}	V	
[STAtE:] SHORt {?} {; NL}	V	0:OFF 1:ON
[STAtE:] PRESet {SP} {ON OFF} {; NL}	V	
[STAtE:] PRESet {?} {; NL}	V	0:OFF 1:ON
[STAtE:] SENSE {SP} {ON OFF AUTO} {; NL}	V	
[STAtE:] SENSE {?} {; NL}	V	0:OFF/AUTO 1:ON
[STAtE:] LEVEl {SP} { LOW HIGH} {; NL}	V	
[STAtE:] LEVEl {?} {; NL}	V	0:LOW 1:HIGH
[STAtE:] LEV{SP} {LOW HIGH} {; NL}	V	
[STAtE:] LEV{?} {; NL}	V	0:LOW 1:HIGH
[STAtE:] DYNAmic {SP} {ON OFF} {; NL}	V	
[STAtE:] DYNAmic {?} {; NL}	V	0:OFF 1:ON
[STAtE:] CLR{; NL}	V	
[STAtE:] ERRor {?} {; NL}	V	
[STAtE:] NO{SP}GOOD {?} {; NL}	V	0 : GO 1 : NG
[STAtE:] NG {?} {; NL}	V	0 : GO 1 : NG
[STAtE:] PROTEct {?} {; NL}	V	
[STAtE:] CCR{SP}{AUTO R2}{; NL} (Note1)	V	
[STAtE:] NGENABLE{SP}{ON OFF}{; NL}	V	
[STAtE:]POLAR{SP}{POS NEG}{; NL}	V	
[STAtE:]START{; NL}	V	
[STAtE:]STOP{; NL}	V	
[STAtE:] TESTING {?} {; NL}	V	0 : TEST END , 1 : TESTING

Table 4-4B STAGE COMMAND SUMMARY

SYSTEM COMMAND:

COMMAND	NOTE	RETURN
[SYStem:] RECall {SP} {m}{; NL}	m=1~150	
[SYStem:] STORe {SP} {m}{; NL}	m=1~150	
[SYStem:] REMOTE {; NL}	RS232/USB/LAN command	
[SYStem:] LOCAL{; NL}	RS232/USB/LAN command	
[SYStem:] NAME {?} {; NL}		"XXXXX"

Table 4-5B SYSTEM COMMAND SUMMARY

measure command:

COMMAND	36XXXA	RETURN
MEASure:CURRent{?}{; NL}	V	###.####
MEASure:VOLTage{?}{; NL}	V	###.####
MEASure:POWer{?}{; NL}	V	###.####

Table 4-6B MEASURE COMMAND SUMMARY

REMARK :

1. Current engineering unit: A
2. Voltage engineering unit: V
3. Resistance engineering unit: Ω
4. Period engineering unit: mS
5. Slew-rate engineering unit: A/uS
6. Power engineering unit: W

Auto sequence:

AUTO SEQUENCE COMMAND	NOTE	RETURN
FILE {SP} {n}{; NL}	n=1~9	1~9
STEP {SP} {n} {; NL}	n=1~16	1~16
TOTSTEP {SP} {n}{; NL}	Total step n=1~16	1~16
SB {SP} {m} {; NL}	m=1~150 m:STATE	
T1 {SP} {NR2} {; NL}	0.1~9.9(s)	0.1~9.9(sec)
T2 {SP} {NR2} {; NL}	0.0~9.9(s)	0.0~9.9(sec)
SAVE {; NL}	Save "File n" data	
REPEAT {SP} {n} {; NL}	n=0~9999	0~9999
RUN {SP} {F} {n} {; NL}	n=1~9	AUTO REPLY "PASS" or "FAIL:XX" (XX=NG STEP)

Table 4-7B Auto sequence command list

4-5. The description of abbreviation

SP : Space, the ASCII code is 20 Hexadecimal.

; : Semicolon, Program line terminator, the ASCII code is 0A Hexadecimal.

NL : New line, Program line terminator, the ASCII code is 0A Hexadecimal.

NR2 : Digits with decimal point. It can be accepted in the range and format of ###.#####.

For Example:

30.12345, 5.0

The description of GPIB programming command syntax.

4-6. Communication Interface programming command syntax description

{ } : The contents of the { } symbol must be used as a part or data of the GPIB command, it cannot be omitted.

[] : The contents of the [] symbol indicates the command can be used or not. It depends on the testing application.

| : This symbol means option. For example "LOW|HIGH" means it can only use LOW or HIGH as the command, it can choose only one as the setting command.

Terminator : You have to send the program line terminator character after send the GPIB command, the available command terminator characters which can be accepted in 36000A Series mainframe is listed in Table 4-9.

LF
LF WITH EOI
CR, LF
CR, LF WITH EOI

Table 4-9 GPIB COMMAND TERMINATOR

Semicolon "; " : The semicolon ";" is a back-up command, the semicolon allows you to combine command statement on one line to create command message.

4-7. Communication Interface programming command description

4.7.1. PRESET Set and Read the Default of Load

RISE

Syntax : [PRESet :] RISE {SP}{NR2}{; | NL}
[PRESet :] RISE{?}{; | NL}

Purpose: Set and read the RISE SLEW-RATE

Description :

1. The definition of RISE SLEW-RATE is load level change or dynamic load can be Programmed of RISE and FALL are completely independent.
2. The value of RISE has to be included the number of the decimal point, otherwise The command will not be available.
3. The least significant number is the 3th behind the decimal point.
4. 36000A Series will set to the maximum value of the model automatically when The Set RISE is over the specification of Load.
5. The unit is A/uS.

FALL

Syntax : [PRESet:] FALL {SP}{; | NL}
[PRESet:] FALL {?}{; | NL}

Purpose : Set and read the FALL SLEW-RATE

Description :

1. The definition of FALL SLEW-RATE is load level change or dynamic load can be Programmed of RISE and FALL are completely independent.
2. 36000A Series will set to the maximum value of the model automatically when the FALL which has been set is over the specification of Load.
3. The unit is A/uS .

PERI or PERD

Syntax: [PRESet:] PERI | PERD : HIGH | LOW {SP}{ NR2}{; | NL}
[PRESet:] PERI | PERD : HIGH | LOW {?}{; | NL}

Purpose: Set and read the TLOW and Thigh of DYNAMIC when loading

Description :

1. A period of loading waveform of DYNAMIC is combined by TLOW and THIGH.
2. The value of TLOW and THIGH have to be included the number of the decimal Point, otherwise the command will not be available.
3. The least significant number is the 5th behind the decimal point.
4. 36000A Series will set the value of TLOW or THIGH automatically when the Value which has been set is over the maximum of the Load.
5. The unit is mS.

LDONv

Syntax: [PRESet:] LDONv {SP}{NR2}{; | NL}
[PRESet:] LDONv{?}{; | NL}

Purpose: Set and Read the voltage of LOAD ON

Description: This command is for setting the Load voltage value of LOAD ON.

LDOFfv

Syntax: [PRESet:] LDOFfv{SP}{ NR2}{; | NL}
 [PRESet:] LDOFfv {?}{; | NL}

Purpose: Set and read the voltage of LOAD OFF

Description: This command is for setting the Load voltage value of LOAD OFF.

CURR : HIGH | LOW

Syntax: [PRESet:] CC | CURR:HIGH | LOW{SP}{ NR2}{; | NL}
 [PRESet:] CC | CURR:HIGH | LOW{?}{; | NL}

Purpose: Set and read the current of HIGH | LOW

Description: This command is for setting the required Load current. And this command must be followed the next notices :

1. The required value of current must be included the number of the decimal point, otherwise the command will not be available.
2. The least significant number is the 5th behind the decimal point.
3. 36000A Series will set the maximum value of current of the Load Automatically when the value which has been set is over the maximum of The load.
4. The value of LOW has to be smaller than HIGH.
5. The unit is A

CP:{HIGH | LOW}

Syntax : [PRESet:] CP:{ HIGH | LOW}{SP}{ NR2}{; | NL}
 [PRESet:] CP:{ HIGH | LOW} {?} {; | NL}

Purpose : Set and read the value of Watt

Description : This command is for setting the required value of Watt, and the unit is W

CR | RES:{HIGH | LOW}

Syntax: [PRESet:] CR | RES:{ HIGH | LOW}{SP}{ NR2}{; | NL}
 [PRESet:] CR | RES:{ HIGH | LOW} {?} {; | NL}

Purpose : Set and read the value of Resistance

Description : This command is used for setting the required value of Load Resistance.

And this command must be followed the next notices:

1. The required value of resistance must be included the number of the decimal point, otherwise the command will not be available.
2. The least significant number is the 3rd behind the decimal point.
3. 36000A Series will set to the maximum value of the model automatically when the value of Resistance which has been set is over the specification of Load.
4. The Resistance value which has been set of LOW has to be smaller than HIGH.
5. The unit is Ω .

CV: {HIGH | LOW}

Syntax: [PRESet:] CV:{ HIGH | LOW}{SP}{ NR2}{; | NL}
 [PRESet:] CV :{ HIGH | LOW}{?} {; | NL}

Purpose: Set and Read the value of Load Voltage

Description: This command is used for setting the required Load Voltage. And this command must be followed the next notices:

1. The required value of resistance must be included the number of the

- decimal point, otherwise the command will not be available.
2. The least significant number is the 5th behind the decimal point.
 3. 36000A Series will set to the maximum value of the model automatically when the value of Voltage which has been set is over the specification of Load.
 4. The Voltage value which has been set of LOW has to be smaller than HIGH.
 5. The unit is Voltage (V)

OCP: START

Syntax: [PRESet:] OCP: START {SP}{NR2}{; | NL}
[PRESet:] OCP: START{?} {; | NL}

Purpose: Set and read the initial value of OCP test

Description: This command is used for setting the required initial value (I-START) of OCP test

OCP: STEP

Syntax: [PRESet:] OCP: STEP {SP}{NR2}{; | NL}
[PRESet:] OCP: STEP {?} {; | NL}

Purpose: Set and read the increasing value of OCP test

Description: This command is used for setting the increasing value(I-STEP) of OCP test

OCP: STOP

Syntax: [PRESet:] OCP:STOP {SP}{NR2}{; | NL}
[PRESet:] OCP:STOP {?} {; | NL}

Purpose : Set and read the maximum value of OCP test

Description : This command is used for setting the maximum value (I-STOP) of OCP Test.

VTH

Syntax: [PRESet:] VTH {SP}{NR2}{; | NL}
[PRESet:] VTH{?} {; | NL}

Purpose: Set and read the value of the Threshold Voltage

Description: This command is used for setting the Threshold Voltage. That is the OCP/OPP of this Load model when the output voltage of appliance is lower or equaled to the VTH

OPP: START

Syntax: [PRESet:] OPP:START {SP}{NR2}{; | NL}
[PRESet:] OPP:START{?} {; | NL}

Purpose: Set and read the initial value of OPP test

Description: This command is used for setting the initial value(P-START) of OPP Test

OPP: STEP

Syntax: [PRESet:] OPP:STEP {SP}{NR2}{; | NL}
[PRESet:] OPP:STEP {?} {; | NL}

Purpose: Set and read the increasing value of OPP test

Description: This command is used for setting the increasing value (P-STEP) of OPP Test

OPP: STOP

Syntax: [PRESet:] OPP:STOP {SP}{NR2}{; | NL}
 [PRESet:] OPP:STOP {?} {; | NL}

Purpose: Set and read the maximum value of OPP test

Description: This command is used for setting the maximum value (P-STOP) of OPP test.

TCONFIG

Syntax: [PRESet:] TONFIG {NORMAL|OCP|OVP|OPP|SHORT}{; | NL}
 [PRESet:] TONFIG {?} {; | NL}

Purpose: Set and read the function of Dynamic test

Description: There are four options of this command. Those are NORMAL mode, OCP test, OPP test and SHORT test.

STIME

Syntax: [PRESet:] STIME {SP}{NR2}{; | NL}
 [PRESet:] STIME {?} {; | NL}

Purpose: Set and read time of the short-circuit test

Description: This command is used for setting time of the short-circuit test. If time set to 0, it means that have no the time limit and continue to be short –circuited. The unit is milli-second (ms)

OCP

Syntax: OCP{?}{; | NL}

Purpose: Set read OCP testing current.

Description: This command is used for setting OCP test read OCP current.

OPP

Syntax: OPP{?}{; | NL}

Purpose: Set read OPP testing watt.

Description: This command is used for setting OPP test read OPP watt.

MPP ?

Syntax: MPP{?}{; | NL}

Purpose: Read MPP (maximum power point) data, Read form: Voltmeter/Ammeter/Power meter.

Description: MPP read form: Voltmeter / Ammeter/ Power Meter.

BATT TYPE

Syntax: BATT:TYPE {SP}{n}{; | NL}

Purpose: This command is used for setting battery type.

Battery discharge test, There are five operating modes as follow:

Note:

1. Type 1 to 3 is manual operation or remote operation.
2. Types 4 to 5 the only remote operation.

BATT UVP

Syntax: BATT:UVP{SP}{NR2}{;|NL}

Purpose: This command is used for setting battery UVP Voltage.

BATT TIME

Syntax: BATT:TIME{SP}{NR1}{;|NL}

Purpose: This command is used for setting battery Discharge time to 1~99999 sec.

BATT STEP

Syntax: BATT:STEP{SP}{n}{;|NL}

Purpose: This command is used for setting TYPE 4 n= 1~3, TYPE 5 n= 1~9.

BATT CCH

Syntax: BATT:CCH{n}{SP}{NR2}{;|NL}

Purpose: This command is used for setting TYPE 4 CC HIGH, Level n=1~3.

BATT CCL

Syntax: BATT:CCL{n}{SP}{NR2}{;|NL}

Purpose: This command is used for setting TYPE 4 CC LOW, level n=1~3.

BATT TH

Syntax: BATT: TH {n}{SP}{NR2}{;|NL}

Purpose: This command is used for setting TYPE 4 Thigh, n=1~3.

BATT TL

Syntax: BATT: TL {n}{SP}{NR2}{;|NL}

Purpose: This command is used for setting TYPE 4 Tlow, n=1~3.

BATT CYCLE

Syntax: BATT: CYCLE {n}{SP}{NR1}{;|NL}

Purpose: This command is used for setting TYPE 4 Cycle: 1~2000, n=1~3.

BATT CC

Syntax: BATT: CC {n}{SP}{NR2}{;|NL}

Purpose: This command is used for setting TYPE 5 Current, n=0~9.

BATT DTIME

Syntax: BATT: DTIME {n}{SP}{NR2}{;|NL}

Purpose: This command is used for setting TYPE 5 Delta time (T1~T9:0~6000sec), n=0~9.

BATT REPEAT

Syntax: BATT: REPEAT {SP}{NR1}{;|NL}

Purpose: This command is used for setting TYPE 4 and TYPE 5 REPEAT time 0~9999.

BATT TEST

Syntax: BATT: TEST {SP}{ON|OFF}{;|NL}

Purpose: This command is used for setting ON: START TEST, OFF: STOP TEST
TYPE 1 & 2 Test end, Auto echo "OK, XXXXX" XXXXX: AH
TYPE 3 ~5 Test end, Auto echo "OK, XXXXX" XXXXX: DVM

CPRSP

Syntax: [PRESet :] CPRSP {SP} {n}{; |NL}

Purpose: Set the CP Mode RESPONSE.

Description: Set the CP Mode RESPONSE, 0: fastest, 4: slowest, the definition is 0.

4.7.2. LIMIT Set and read the top and bottom of the Load judgment NG limit

[LIMit:]CURRENT:{ HIGH | LOW} or IH | IL

Syntax: [LIMit]:CURRENT:{ HIGH | LOW}{SP}{ NR2 }{; |NL}

[LIMit]:CURRENT:{ HIGH | LOW}{?}{; |NL}

[IH | IL]{SP}{ NR2 }{; |NL}

[IH | IL]{?}{; |NL}

Purpose: To set the upper/lower limit value of threshold current.

Description: This command is to set the lower limit value of threshold current. When load sink current is lower than this lower limit value or higher than the upper limit value, NG indicating light will come on to indicate "NO GOOD".

[LIMit:]POWER:{ HIGH | LOW} or WH | WL

Syntax: [LIMit]:POWER:{ HIGH | LOW}{SP}{ NR2 }{; |NL}

[LIMit]:POWER:{ HIGH | LOW}{?}{; |NL}

[WH | WL]{SP}{ NR2 }{; |NL}

[WH | WL]{?}{; |NL}

Purpose: To set the upper/lower limit value of threshold power (W).

Description: This command is to set the upper/lower limit value of threshold power (WATT). When power (WATT) is lower than this lower limit value or higher than the upper limit value, NG indicating light will come on to indicate "NO GOOD".

[LIMit:] VOLTage:{ HIGH | LOW} or VH | VL

Syntax: [LIMit] VOLTage:{ HIGH | LOW}{SP}{ NR2 }{; |NL}

[LIMit] VOLTage:{ HIGH | LOW}{?}{; |NL}

[VH | VL]{SP}{ NR2 }{; |NL}

[VH | VL]{?}{; |NL}

Purpose: To set the upper/lower limit value of threshold voltage.

Description: This command is to set the upper/lower limit value of threshold voltage. When input voltage is lower than the lower limit value or higher than the upper limit value, NG indicating light will come on to indicate "NO GOOD".

[LIMit:] SVH | SVL

Syntax: [LIMit:] {SVH | SVL}{SP}{ NR2 }{; |NL}

[LIMit:] {SVH | SVL}{?}{; |NL}

Purpose: To set the upper/lower limit value of short current.

Description: This command is to set the upper/lower limit value of short current. When short current is lower than the lower limit value or higher than the upper limit value, NG indicating light will come on to indicate "NO GOOD".

[LIMit:]ADDCV: VOLTage

Syntax: [LIMit:] ADDCV:VOLTage{SP}{ NR2 }{; |NL}

[LIMit:] ADDCV:VOLTage{SP}{?}{; |NL}

Purpose: Set and read CV+Current limit or CV+Power limit mode of Constant Voltage setting .

Description: This command is used for set and read Constant Voltage setting, when Set to CV+Current limit, the of Load like Constant Current status, until EUT Voltage equal setting Constant Voltage, into a Constant Voltage mode.

This command is used for setting and read Constant Voltage setting, when Set to CV+Power limit, the of Load like Constant Power status, until EUT Voltage equal setting Constant Voltage, into a Constant Voltage mode.

[LIMit:]ADDCV:VOLTage{SP}{ON | OFF}

Syntax: [LIMit:] ADDCV:VOLTage{SP}{ON OFF}{; |NL}

Purpose: Start and stop CV+Current limit or CV+Power limit test mode.

Description: At that time in Constant current mode or constant power mode to perform CV+Current limit or CV+Power limit mode.

4.7.3. STAGE Set and read the status of Load

[STATe:] LOAD{SP}{ON | OFF}

Syntax: [STATe:] LOAD{SP}{ON | OFF}{; |NL}

[STATe:] LOAD {?}{; |NL}

Purpose: Set and read the status of Sink Current or not

Description: This command is used for setting the status of Sink Current . When setting it to ON, the Load is going to sink current from appliance. When setting it to OFF, the Load would not act.

[STATe:] MODE {SP}{CC | CR | CV | CP}

Syntax: [STATe:] MODE {SP}{CC | CR | CV | CP}{; |NL}

[STATe:] MODE {?}{; |NL}

Purpose: Set and read the mode of LOAD

Description: Load is acting under these four modes as the following TABLE 4-10. When reading the Loading Operation mode, the return value 0 | 1 | 2 | 3 are meant to be CC | CR | CV | CP

	CC (0)	CR (1)	CV (2)	CP (3)
36XXXA	V	V	V	V

Table 4-10 module for each series

[STATe:] SHORt {SP}{ON | OFF}

Syntax: [STATe:] SHORt {SP}{ON | OFF}{; |NL}

[STATe:] SHORt {?}{; |NL}

Purpose: Set and read the short-circuit test of Load

Description: This command is for setting the Load to make a short-circuit test. While

setting for the ON, the V+, V- pin of Load like short-circuit status.

[STATe:] PRESet {SP}{ON | OFF}

Syntax: [STATe:] PRESet {SP}{ON | OFF}{; | NL}
[STATe:] PRESet {?} {; | NL}

Purpose: Set the left or right digit multi-function meter to display the programming load level.

Description: This command is for select the left 5 digit LCD display to show current setting or DWM.

Pres ON: To select the LCD display to shows current setting

Pres OFF: To select the LCD Display is "DWM"

[STATe:] SENSE{SP}{ON | OFF | AUTO}

Syntax: [STATe:] SENSE{SP}{ON | OFF | AUTO}{; | NL}
[STATe:] SENSE {?} {; | NL}

Purpose: Set and read the Load voltage to read whether is carried by the VSENSE or not.

Description: This command is for setting the Load voltage to read whether is carried by VSENSE or INPUT Connector. When setting for ON, the voltage is got from VSENSE, and setting for OFF, the voltage is got from INPUT Connector. In 36000A Series, the optional are ON and AUTO. So, if setting for AUTO, it means the voltage is got and read from VSENSE. But if no voltage is inputted from VSENSE, the voltage will be inputted from INPUT Connector.

[STATe:] LEVel {SP}{HIGH | LOW} or LEV {SP}{HIGH | LOW}

Syntax: [STATe:] LEVel {SP}{HIGH | LOW}{; | NL}
[STATe:] LEVel {?} {; | NL}
[STATe:] LEV{SP}{HIGH | LOW}{; | NL}
[STATe :] LEV{?} {; | NL}

Purpose: Set and read the LOW and HIGH of Load

Description: LEV LOW is a low level value of current on CC mode. It is a low level value of resistance on CR mode. It is a low level value of voltage on CV mode. It is a low level value of power on CP mode.

[STATe:] DYNamic{SP}{ON | OFF}

Syntax: [STATe:] DYNamic{SP}{ON | OFF}{; | NL}
[STATe:] DYNamic {?} {; | NL}

Purpose : Set and read whether the status is Dynamic or Static of Load

Description:

1. DYN ON , set for a DYNAMIC Load
2. DYN OFF, set for a STATIC Load

[STATe:] CLR

Syntax: [STATe:] CLR {; | NL}

Purpose: Clear the error flag of 36000A Series which during the period of working

Description: This command is for clearing the contents in the register of PROT and ERR. After implementation, the contents of these two registers will be "0".

[STATe:] NG ?

Syntax: [STATE:] NG{?}; |NL}

Purpose: Query if there have NG flag in this 36000A Series

Description: Set command NG ? to show the NG status. Set for "0" the LCD of NG(NO GOOD) will be put out .Set for "1" the LCD will be lit. -

[STATE:] PROTECT ?

Syntax: [STATE:] PROTECT{?}; |NL}

Purpose: Query if there have protection flag which had been set in this 36000A Series

Description:

1. PROT? Means the status of Protection of 36XXXA. "1" means OPP occurred."4"means OVP. "8" means OCP. Table 4-11 shows the corresponding number of protection status
2. Use command CLR to clear the register of PROT status to be "0"

Bit 7	Bit 6	Bit 5	Bit 4	Bit 3	Bit 2	Bit1	Bit 0
7	6	5	4	3	2	1	0

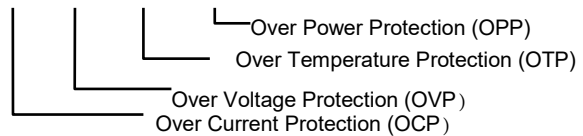

BIT ID	BIT VALUE	REMARK
bit 0	0 = Off, 1 = Triggered	Over Power Protection (OPP)
bit 1	0 = Off, 1 = Triggered	Over Temperature Protection (OTP)
bit 2	0 = Off, 1 = Triggered	Over Voltage Protection (OVP)
bit 3	0 = Off, 1 = Triggered	Over Current Protection (OCP)

Table 4-11 register of PROT status

[STATE:] CCR {AUTO | R2}

Syntax: [STATE:] CCR {AUTO | R2}; |NL}

Purpose: Set the CC MODE RANGE to be forced to switch to RANGE II

Description: It will switch the RANGE position automatically when setting for AUTO Set R2 when implementing RANGE II

[STATE:] NGEABLE {ON | OFF}

Syntax: [STATE:] NGEABLE {ON | OFF} ; |NL}

Purpose: To set the GO/NG check function enable or disable.

Description: To set the function of NG judgment opens when POWER ON. When setting for POWER OFF, the function of NG judgment will not be implemented.

[STATE:] POLAR {POS | NEG}

Syntax: [STATE:] POLAR {POS | NEG} ; |NL}

Purpose: Set for the display of the voltage meter shows the pole is contrary or not.

Description: Set the display of the voltage meter shows the pole. If it shows POS that means the pole is not contrary. If the pole is contrary, it will show NEG

[STATe:] START

Syntax: [STATe:]START {; |NL}

Purpose: Set for Load to implement the test.

Description: Set for Load to implement the test, and according to TEST CONFIG (TCONFIG), the Load will start to test the items and parameters which are Required

[STATe:] STOP

Syntax: [STATe:] STOP {; |NL}

Purpose: Set for Load to stop the test

4.7.4. SYSTEM Set and Read the Status of 36000A Series

[SYStem:] RECall{ SP }m{ ,n }

Syntax: [SYStem:] RECall{ SP }m{; |NL}

Purpose: Recall the status of Loading which had been saved in the Memory

Description: This command is for recalling the status of Load which had been saved In the Memory.

m(STATE)=1~150 ◦

For Example

RECALL 2 → Recall the status of Loading which had been saved in the 2nd of the memory

[SYStem:] STORe{SP}m{n}

Syntax: [SYStem:] STORe{SP}m{ ; |NL}

Purpose: Save the status of Loading to the Memory

Description: This command is for saving the status of Loading to the Memory.

m(STATE)=1~150

For Example

STORE 2 → Save the status of loading which had been saved in the 2nd of memory.

	36XXXXA
STATE(m)	150

[SYStem:] NAME ?

Syntax:[SYStem:] NAME{?} {; |NL}

Purpose: Read the model number of Load

Description: This command is for reading the model number of Load. If no module is Operating, the display will be lit “NULL”, or it will be lit the model number as table 4-12:

MODEL
36XXXXA

Table 4-12 MODEL NUMBER

[SYStem:] REMOTE

Syntax: [SYStem:] REMOTE { ; | NL }

Purpose: Command to enter the REMOTE status (only for RS232)

Description: This command is for controlling the RS232

[SYStem:] LOCAL

Syntax: [SYStem:] LOCAL { ; | NL }

Purpose: Command to exit the REMOTE status (only for RS232)

Description: This command is for finishing the RS232

4.7.5. MEASURE Measure the actual current and voltage value of Load

MEASure: CURRent ?

Syntax: MEASure: CURRent{?}{ ; | NL }

Purpose: Read the current which is loading of Load

Description: Read the five numbers of current meters, and the unit is Ampere (A)

MEASure: VOLTage ?

Syntax: MEASure: VOLTage{?}{ ; | NL }

Purpose: Read the voltage which is loading of Load

Description: Read the five numbers of current meters, and the unit is Voltage (V)

MEASure: POWer ?

Syntax: MEASure: POWer{?}{ ; | NL }

Purpose: Read the power which is loading of Load

Description: Read the five numbers of current meters, and the unit is Watt (W)

Chapter 5 Applications

This chapter details the basic operating modes along with some common applications in which the 36000A series Electronic Load are used.

5-1. Local sense connections

Local sensing is used in applications where the lead lengths are relatively short, or where load regulation is not critical. When connected in local sense mode the 5 digit voltage meter of the 36000A series Electronic load measures the voltage at its DC input terminals. The connecting leads between the DUT and the Electronic Load should be bundled or tie wrapped together to minimize inductance.

Fig 5-1 illustrates a typical set up with the electronic load connected to the DC power supply.

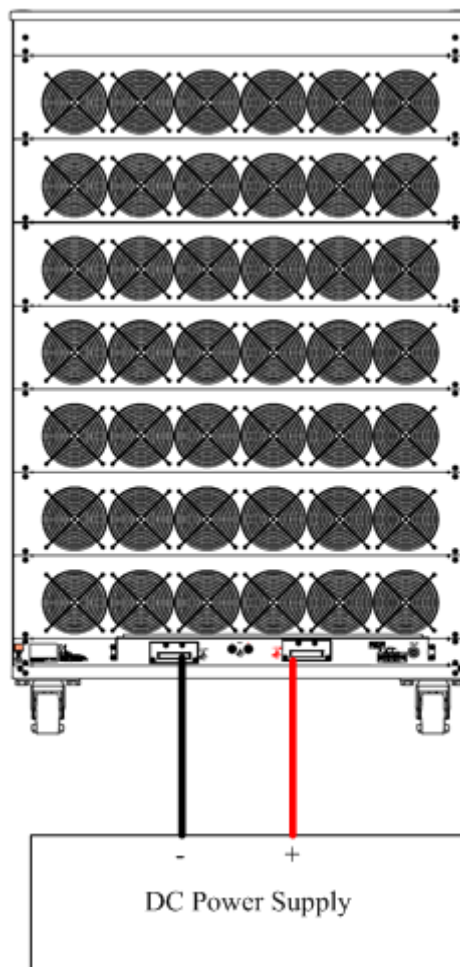

Fig 5-1 Local voltage sense connections

5-2. Remote sense connections

Remote sensing compensates for the voltage drop in applications that require long lead lengths. It is useful under low voltage high current conditions. The remote voltage sense terminals (V_{s+}) and (V_{s-}) of the load are connected to (+) and (-) output of the DC Source. Be sure to observe the correct polarity or damage may occur. The power and sense cables should be bundled or tie wrapped together to minimize inductance.

Fig 5-2 illustrates a typical set up with the electronic load connected for remote sense operation.

If V-sense is set to 'ON' and the sense terminals are connected to the DUT the load will check and compensate for all voltage drops. The maximum voltage sense compensation is the same as the rating of the 36260A.

For example V_{max} of 36260A is 600Vdc so maximum V_{sense} is also 600Vdc.

For example V_{max} of 36360A is 1000Vdc so maximum V_{sense} is also 1000Vdc.

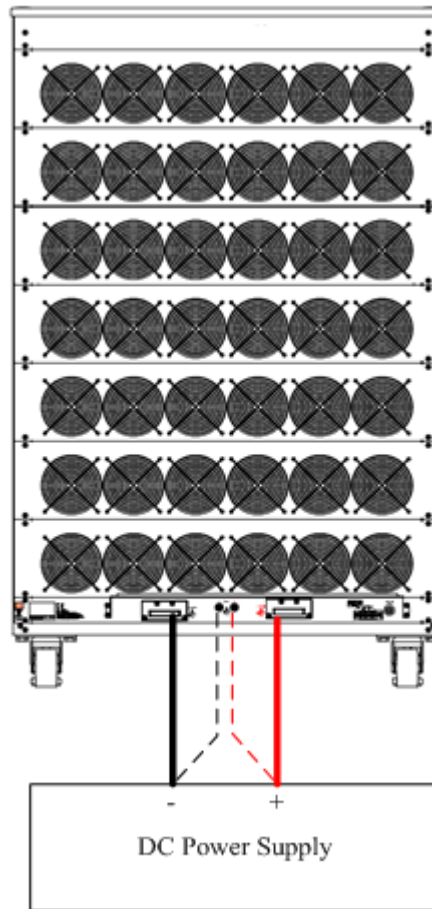

Fig 5-2 Remote voltage sense connections

5-3. Constant Current mode application

The Constant Current (CC) mode is ideal for testing the Load Regulation, Cross Regulation, Output Voltage and Dynamic Regulation of the power supply under test. The CC mode can also be used to test the Discharge Characteristics and the Life Cycle of cells and battery packs. In CC operation the 36000A series can operate as a static load with switchable high and low current levels. It is also possible to operate the load dynamically enabling the user to adjust sink current with time.

5.3.1 Static mode: (Fig 5-3)

Major application areas include:

- Voltage source testing
- Power supply load regulation testing
- Battery discharge testing

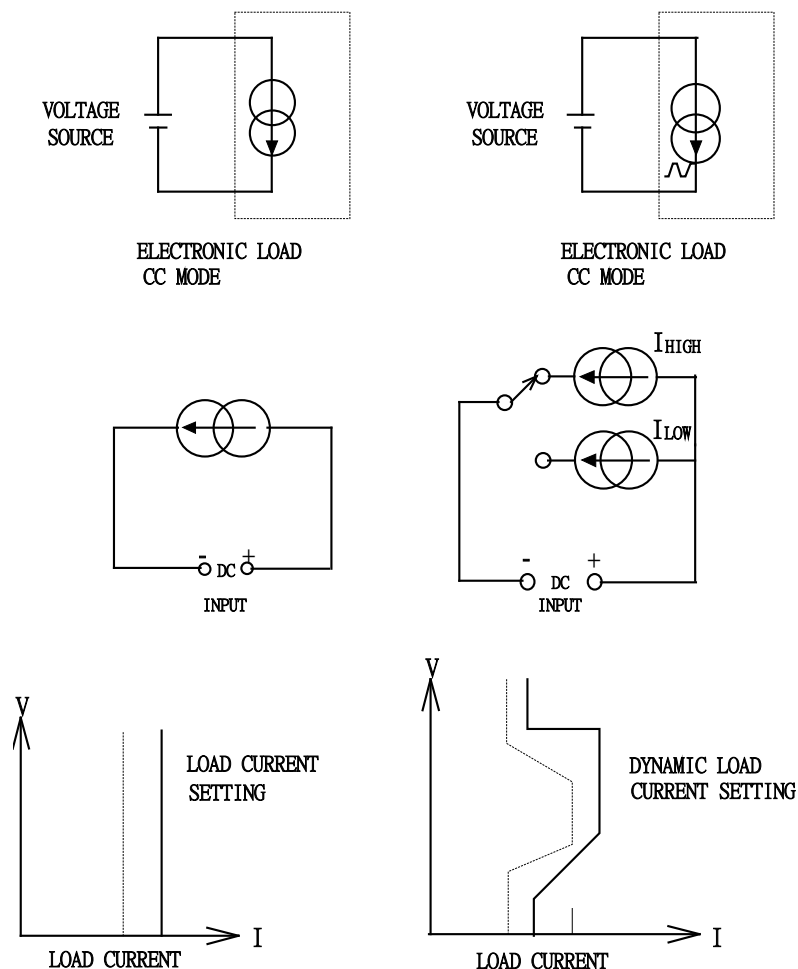

Fig 5-3 constant CURRENT mode application

5.3.2 Dynamic mode:

The built-in pulse generators allow the user to recreate real world loads that vary With time

Major application areas for dynamic operation in CC mode include:

- Power supply load transient response testing
 - Power recovery time testing
 - Battery Pulse load simulation
 - Power component testing
 - Two levels of current can be set and the rate of change between the 2 current Levels can be adjusted in relation to time. The current rise (slew) rate and the current fall (slew) rate can be adjusted independently from each other and are further defined below
- Rise slew rate = $| I_{low} - I_{high} | / T_a$ (A/us)
 - Fall slew rate = $(I_{high} - I_{low}) / T_b$ (A/us)
 - Rise time (Ta) = $(I_{low} - I_{high}) / \text{Rise slew rate}$
 - Fall time (Tb) = $(I_{high} - I_{low}) / \text{Fall slew rate}$
- Please see Fig 1-11 for more information on slew rates.
 - The time the waveform is high (Thigh) and the time the waveform is low (Tlow) can
 - Also be adjusted. The diagram below shows the 6 adjustable parameters that
 - Define the dynamic waveform.

5.3.3 Analogue programming input

The analogue programming input can also be used in CC mode. The analogue Programming input allows a complex dynamic waveform to be set up on an external oscillator. The 36000A series load will track and load according to the external Signal as long as it is within its dynamic capability. The input signal can be the Range of 0-10V (dc+ac). The 10V is proportional to the full current capability of the Load.

More information on the analogue programming input can be seen in section 3.2.

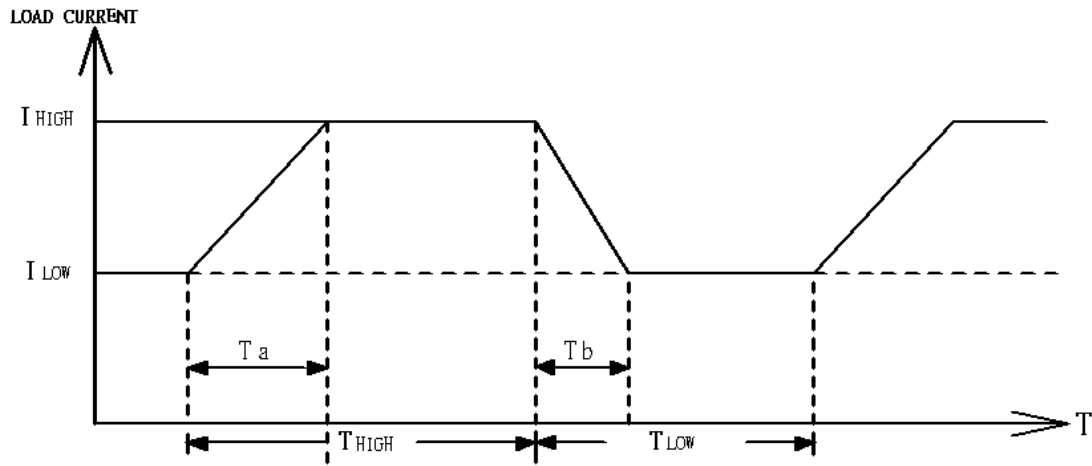

Fig 5-4 Dynamic load current with independent programmed Rise/Fall slew rate

5-4. Constant Voltage mode application

In Constant Voltage (CV) operation the load will attempt to sink as much current as required in order to reach the set voltage value. CV operation is useful in checking the load regulation of dc current sources. The CV mode is also ideal for characterizing the current limit of dc power supplies. These application areas are explained a little more below.

5.4.1 Current source testing.

A common application for a dc current source is as a battery charger. Most battery chargers are designed to automatically adjust their charging current according to the battery voltage. In CV mode the electronic load will sink the current that is needed to reach the desired voltage. The CV mode is therefore ideal for checking the charge current at a particular voltage level.

If the battery charger is tested at a number of different voltage levels in CV mode a current curve can be recorded. Thus the battery charger's load regulation can be checked during development, production and batch testing.

5.4.2 Power supply current limit characterization

The current limit is a necessary function for power supplies. The fold back current limit curve is very common for fixed output switching power supplies. The constant current limit curve is more popular for adjustable laboratory power supplies.

It is very difficult or impossible to find the current limit curve by CC or CR mode. However it becomes simple by using CV mode. The user sets the CV voltage and Records the output current. Plotting the current measurements against the voltage Settings result in the output current limit curve of a power supply (Figure 5-5).

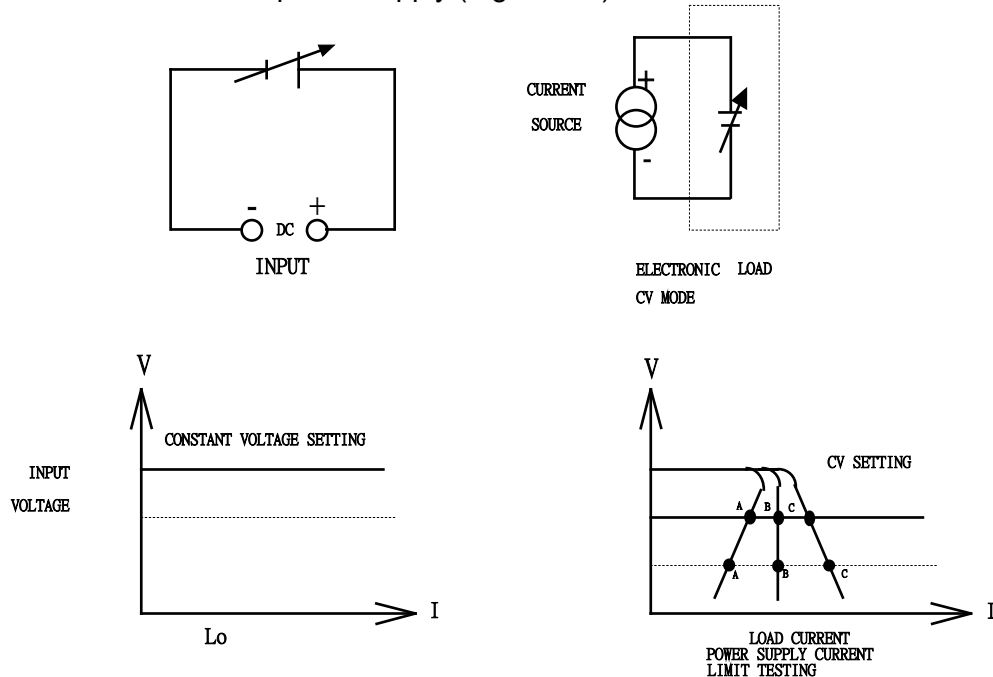

Fig 5-5 Constant Voltage mode application

5-5. Constant Resistance mode application

Operating in Constant Resistance mode is useful for testing both voltage and current sources. The CR mode is particularly suited for the 'soft start' of power supplies. This is explained in more detail below.

5.5.1 Power supply power up sequence

In constant current mode the demand at initial 'Load ON' of the preset current value is almost instantaneous. This might cause the Device under Test (DUT) problems meeting the relatively high current demand at initial switch on. .

For example: A 5V/50A output power supply may not be able to deliver 50A over its entire start-up range of 0-5 volts. In many cases the power supply's short circuit or over current protection circuit cause the power supply to shut down. This is because the power supply is trying to deliver the 50A at a voltage level that is too low.

The answer to this problem is not to use CC mode but to use CR mode instead. This is because in CR mode the current and voltage ramp up together providing a 'soft start' when compared to standard CC mode.

However please note that with the 36000A series of Electronic Loads allow an adjustable current ramp can be set. This feature is found within the dynamic settings as RISE slew rate. Even in static mode the 36000A series load will regulate its current demand at 'Load ON' in line with the adjusted RISE slew rate. The FALL slew rate also in the dynamic settings allows the current ramp down to be controlled at 'Load OFF'.

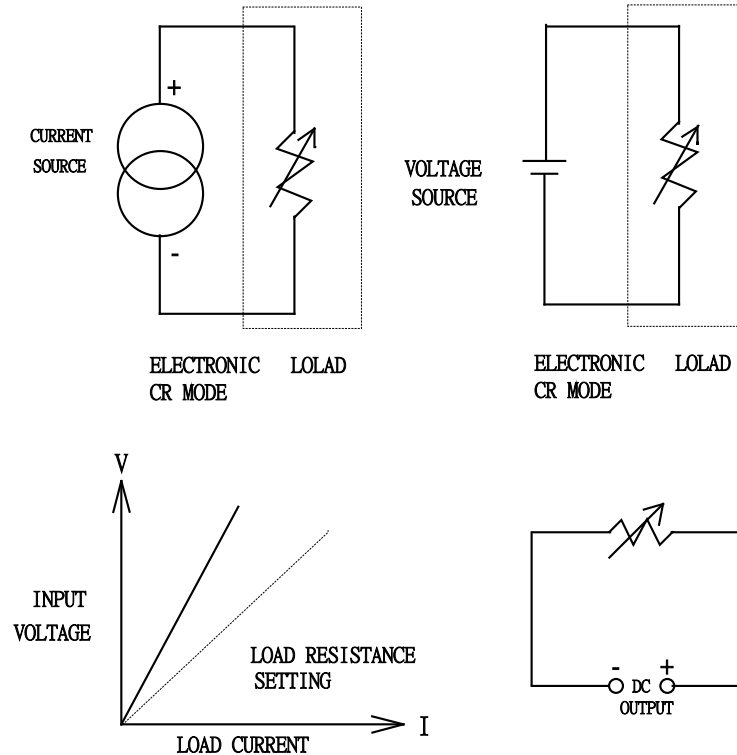

Fig 5-6 Constant Resistance mode Application

5-6. Constant Power mode application

5.6.1. Battery Evaluation

Primary or secondary batteries are the power source for a wide range of portable electronics products, such as notebook computers, video cameras and mobile phones. To ensure long usage times and customer satisfaction the battery pack should be able to provide a constant power for the longest time possible.

It can be measured that the output voltage of a battery will drop over time (Fig 5-7a). The rate of voltage decay depends on a number of factors including duty cycle, chemistry type, battery age and ambient temperature.

So to keep the device powered for the longest possible time the battery must be able to provide a stable power output regardless of output voltage (Fig 5-7c). In order to maintain a constant power the output current will need to increase over time to compensate for the reducing voltage (Fig 5-7b).

Operating the 36000A series electronic load in CP mode is ideal for testing the characteristics of a battery. This is because as the battery voltage drops the load current will automatically increase in order to keep the CP setting. By logging sink values against time the test engineer can also measure the battery's energy capacity at various discharge rates.

The 36000A series also features an adjustable Load OFF setting. This allows a voltage level to be set so that the electronic load automatically stops sinking power upon reaching this preset voltage. This can be used to ensure the battery is not subjected to a damaging deep discharge.

Along with static operation the load can also be operated dynamically in CP mode. The dynamic functions allow the ramp, fall and plateau times to be adjusted between 2 levels of power. This capability means that 'real world' loads can be more accurately simulated. For example the dynamic mode could be used to test the performance of a battery that is required to provide power pulses to transmit data from a radio frequency terminal.

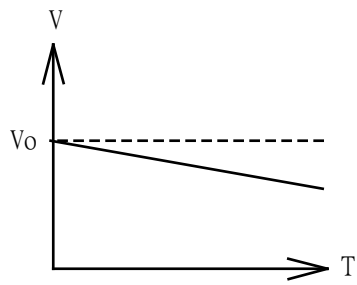

(a) The output voltage of battery

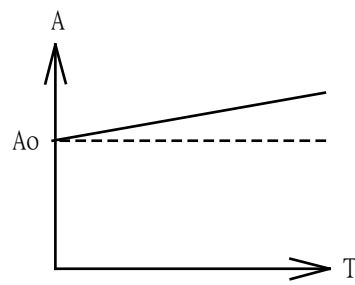

(b) The output current of battery

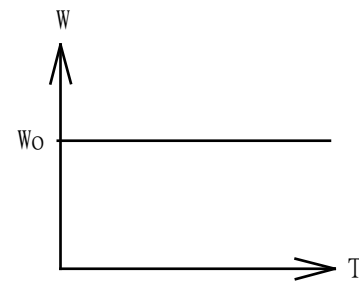

(c) The output power of battery

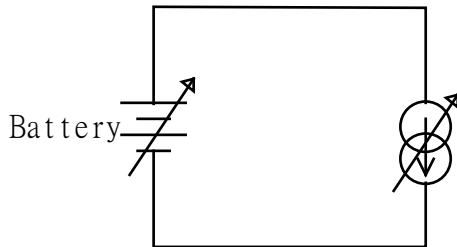

(d) Constant Power Mode (STATIC)

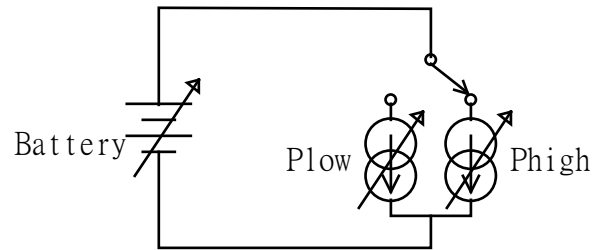

(e) Constant Power Mode (DYNAMIC)

Fig 5-7 CONSTANT POWER MODE APPLICATION

Note: The CP mode battery is discharged. When CP CPRSP = 0 (preset value), the wiring must be as short as possible.

1. Connect Vsense for voltage drop compensation (please refer to section 5-2 for Instructions)
2. Or use CPRSP = 1 ~ 4, the SPRSP setting in the Config key.

Note: CPRSP settings will not be stored when turned off, When the 36XXXA power is turned on, the CPRSP gear position must be set.

5-7. Applications with current limiting or power limiting function CV mode operation (charging device)

Operating in the current-limiting CV mode, the 36000A series can limit current or power when operating at a Constant voltage load. It is especially suitable for charging piles, Constant current sources and other power product testing applications.

Operation method:

- Connect the DUT to the LOAD INPUT terminal
- Switch the electronic load to CC Mode or CP Mode first, and press the Preset key to set the current limit point or power limit point.
- Press the Limit key, and "Add.CV" will appear on the LCD display. At this time, after setting the CV value to be set, press START KEY to start the test.
- If you need to modify the current limit or power limit during the test, you can change the current limit or power limit after pressing the Preset button again.
- If you need to change the CV test point during the test, press the Limit button again, and "Add.CV" will appear on the LCD screen again. At this time, the CV setting value can be changed.
- Finally, press STOP KEY to stop the test.

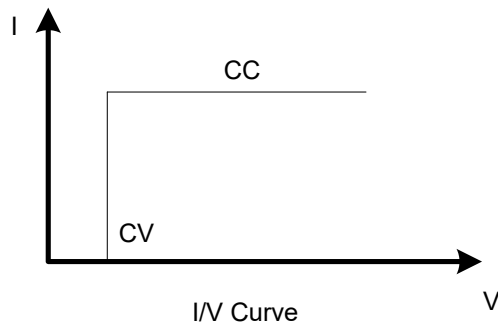

Remote control CV + current limit or power limit

for example

- REMOTE (Set up remote control)
- MODE CC or CP (Set to CC or CP mode)
- CC:HIGH 20 or CP:HIGH 2000 (Set current limit to 20A or limit power 2000W)
- LIM:ADDCV:VOLT 50 (Set the Constant voltage to 50V)
- LIM:ADDCV ON (Start testing CV + current limit or power limit mode)
- LIM:MEAS: CURR? (Read the current value of the electronic load)
- LIM:MEAS: VOLT? (Read the voltage value of the electronic load)
- LIM:ADDCV:CURR 25 (Modify the current limit to 25A during the test)
- LIM:ADDCV:POW 2500 (Modify the power limit point to 2500W during the test)
- LIM:ADDCV:VOLT 40 (Modify the Constant voltage to 40V)
- LIM:ADDCV OFF (Stop testing CV + current limit or power limit mode)

5-8. Applications with current limiting or power limiting function CV mode operation (Discharging device)

Operate in CC mode to CV mode, 36000A series at the same time as a Constant Current and Constant Voltage Load, as shown in Fig 5-8.

When Operating at Constant Current (CC) load, 36000A series electronic load to Voltage source (VBatt) Constant Current load (I) and keep Constant Voltage.

When Operating at Constant Voltage Load on, the VBatt is greater than V, Input current changes its input voltage is keep fixed.

When the VBatt voltage is less than equal to the set voltage CV, the load does not sink current.

Operation Way:

- Load input terminals are connected to the DUT
- Change to CC mode and setting CC current setting.
- Press Limit key to setting the CV voltage and the display will show "+Add.CV".
- Press START key to start up the CV+Current limit test, and press "STOP" key to stop CV+Current limit Test.

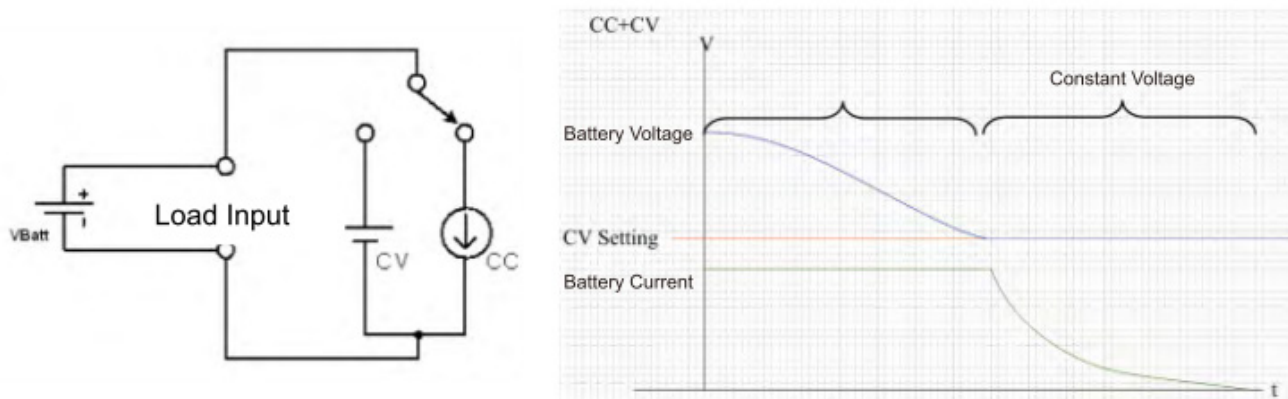

Fig 5-8 CV+Current limit mode operation application

Remote Control CV+Current limit

for example :

```

REMOTE          ( Setting Remote Control )
MODE CC         ( Setting CC mode )
CC : HIGH 20    ( Setting load on current 20A )
LIM: ADDCV:VOLT 50 ( Setting Constant Voltage is 50V )
LIM: ADDCV ON   ( Start testing CC to CV mode )
LIM: MEAS : CURR? ( Read current value )
LIM: MEAS : VOLT? ( Read Voltage value )
LIM: ADDCV: CURR 25 ( Modify the current limit to 25A during the test )
LIM : ADDCV OFF ( Stop testing CC switch to CV mode )

```

5-9. Application with switching from CP mode to CV mode operation (battery discharge)

Operating in CP to CV mode, 36000A series at the same time as a Constant Power and Constant Voltage Load, as shown in Fig 5-9.

When Operating at Constant Power (CP) load, 36000A series electronic load provides Specified power, independent Constant Voltage source (VBatt) is output voltage.
 When Operating at Constant Voltage Load on, the VBatt is greater than V, Input power Changes its input voltage is keep fixed.

When the VBatt voltage is less than equal to the set voltage CV, the load does not sink Current.
 Operation Way:

- Load input terminals are connected to the DUT
- Change to CP mode and setting CP power setting.
- Press Limit key to setting the CV voltage and the display will show "Add.CV".
- Press START key to start up the CP to CV test, and press "STOP "key to stop CP to CV Test.

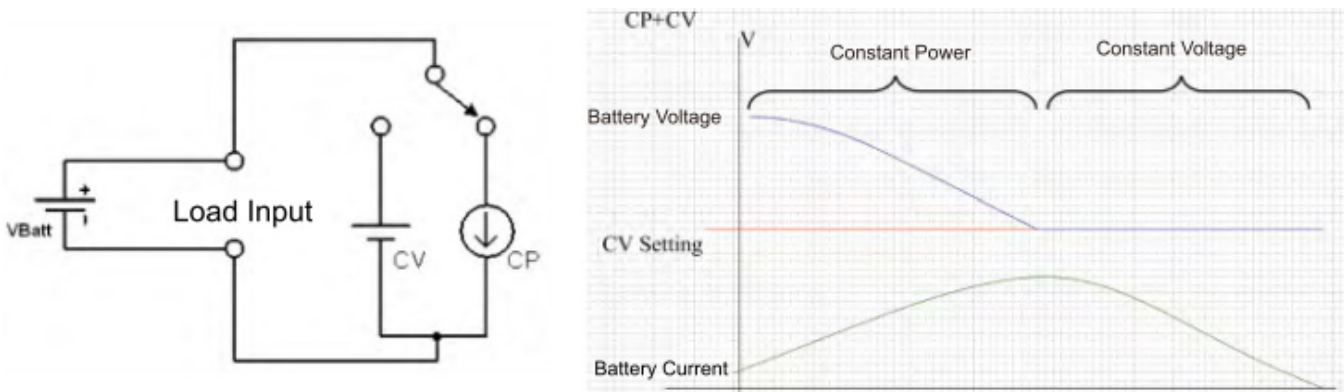

Fig 5-9 Application of CP to CV operation mode

Remote control CP to CV mode
 for example :

- | | |
|---------------------|---|
| REMOTE | (Setting Remote Control) |
| MODE CP | (Setting CP mode) |
| CP : HIGH 100 | (Setting Constant power is 100W) |
| LIM: ADDCV: VOLT 50 | (Setting Constant Voltage is 50V) |
| LIM: ADDCV ON | (start test CP to CV mode) |
| LIM: MEAS : POW? | (Read Power value) |
| LIM: MEAS : VOLT? | (Read Voltage value) |
| LIM: ADDCV:POW 2500 | (Modify the power limit point to 2500W during the test) |
| LIM : ADDCV OFF | (stop test CP to CV mode) |

5-10.Parallel operation

It is possible to operate load in parallel if the power and/or current capability of a single 36000A series load is not sufficient.

The positive and negative outputs of the power supply are connected individually to each load module as shown in the Fig 5-10 below. The setting is made at each individual load module. The total load current is the sum of the load currents being taken by each load.

While in static mode the load modules can be set to operate in CC, CR or CP. When using multiple loads to sink power from a single DC Source it is not permissible to operate in dynamic mode.

- Note:
1. the electronic load only may carry on the parallel operation under the fixed electric current pattern.
 2. The electronic load do not use under series connection.

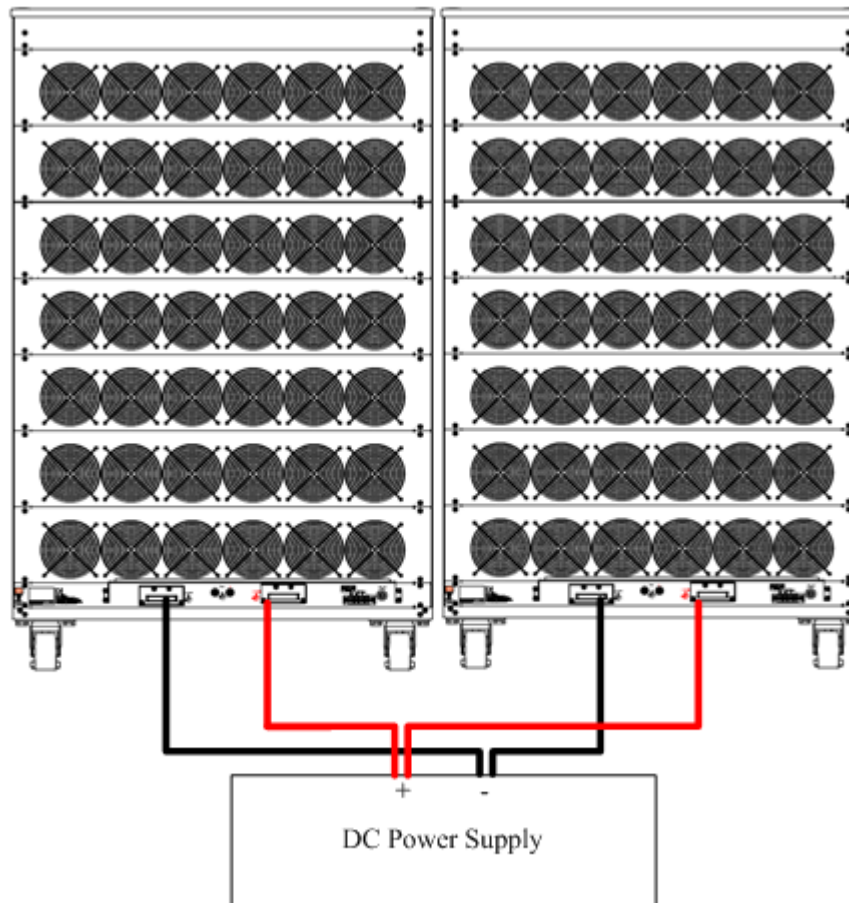

Fig 5-10 36000A series load parallel operation

5-11. Zero-Volt loading application

As shown in Fig 5-11, the electronic load can be connected in series with a DC voltage Source which output voltage greater than 10V. so that the device under test that are connected to the electronic load can be operated down to a Zero- Volt condition, the DC voltage source provides the minimum 10V operating voltage required by the Electronic load. This application is suitable for low voltage Battery cell with high discharge current testing.

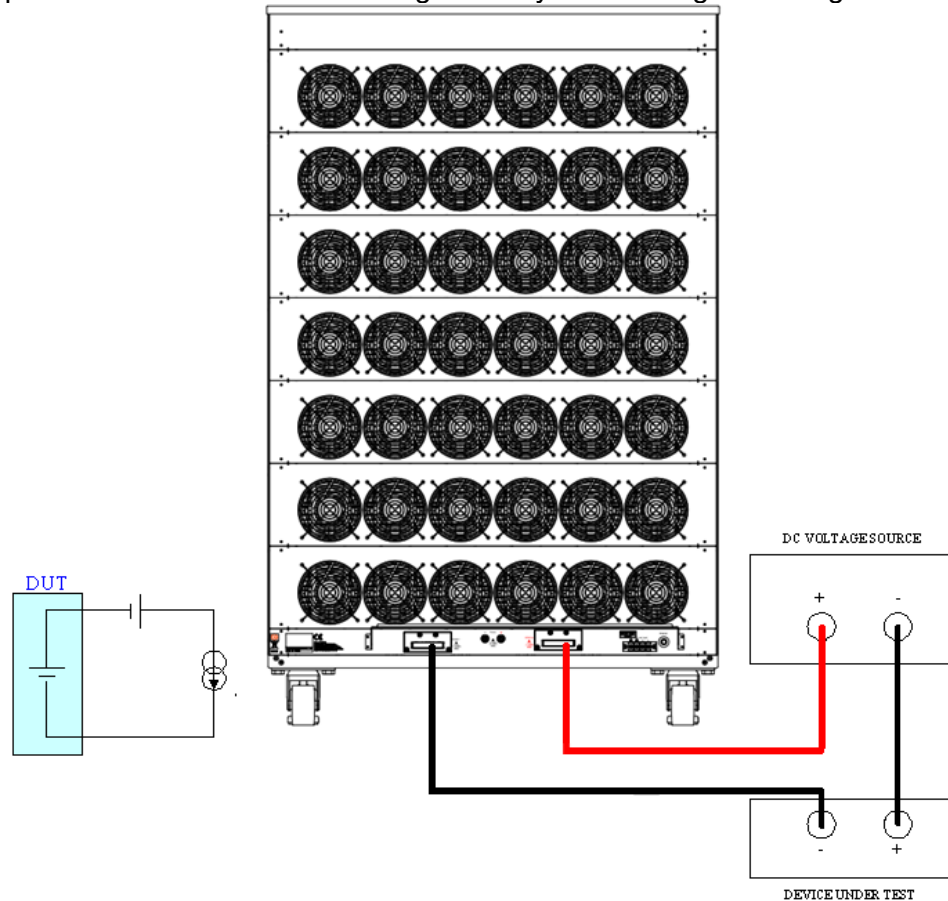

Fig 5-11 Zero-Volt loading connection

5-12.36000A series electronic load OCP, OPP, SHORT operation flow Chart

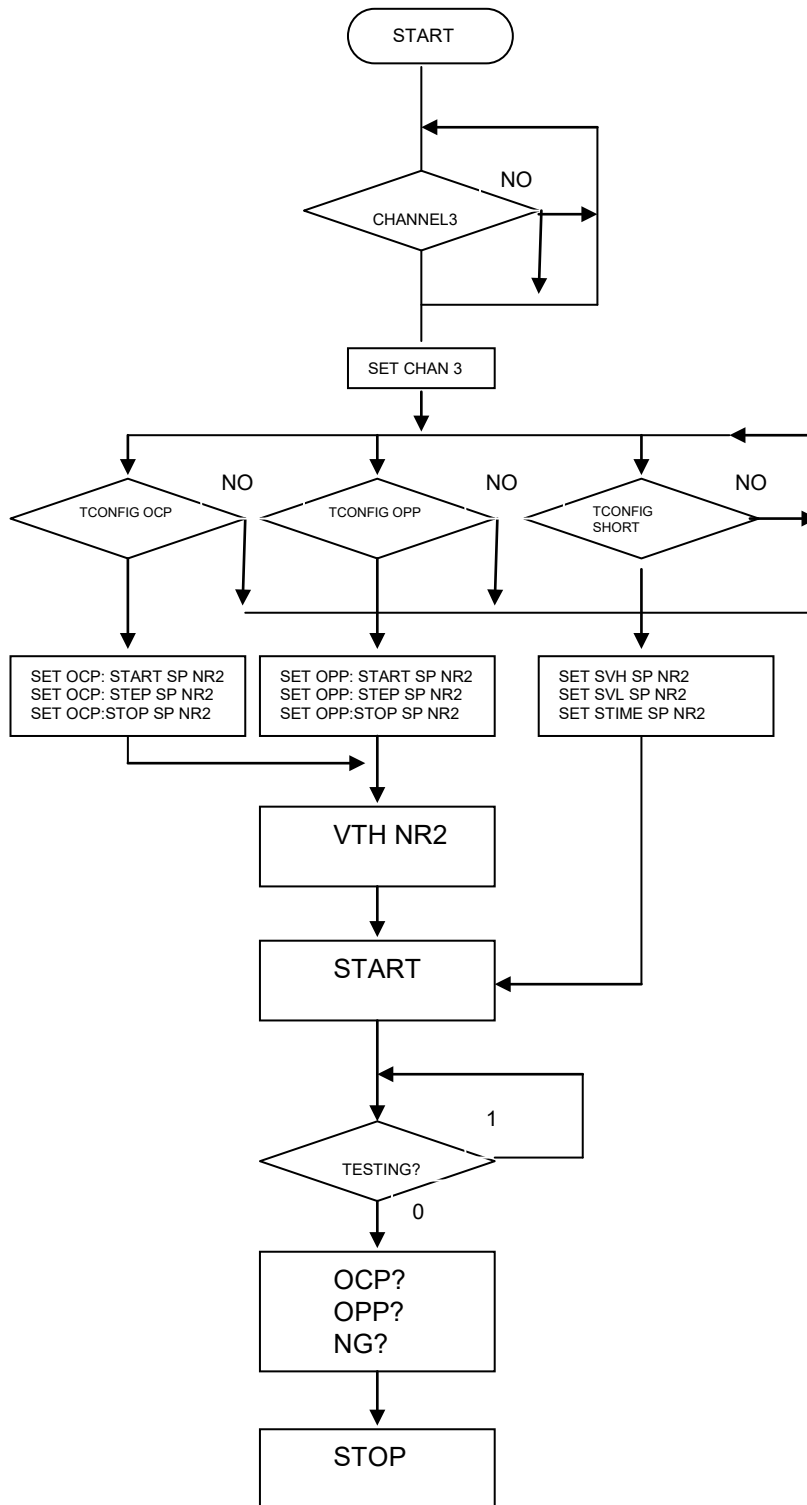

Fig 5-12 36000A series electronic load OCP, OPP, and SHORT operation flow chart

5-13. Power Supply OCP testing

5.13.1. OCP Manual control

Example:

5.13.1.1. First, press Limit Key function to setting I_Hi 8A.

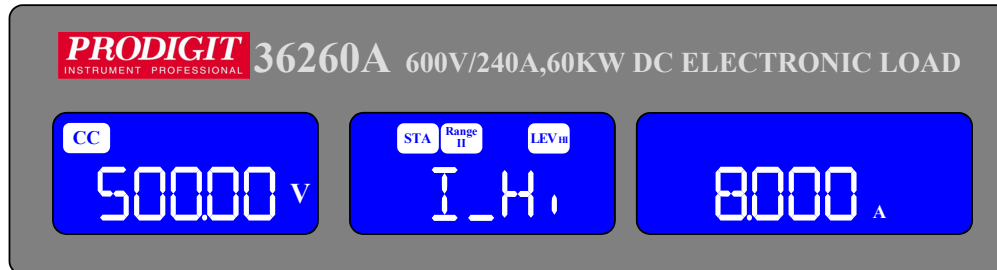

5.13.1.2. Press Limit Key function to setting I_Lo 0A.

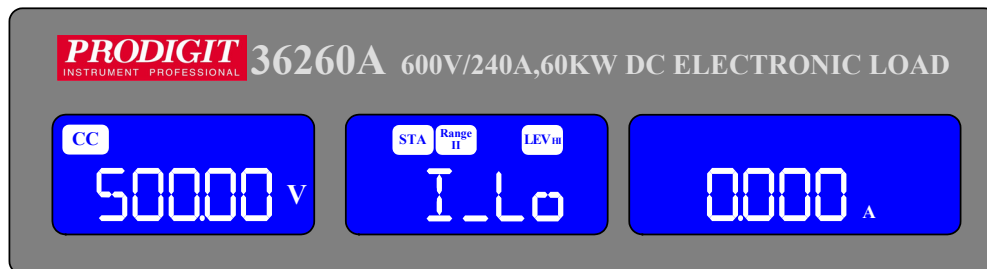

5.13.1.3. Setting OCP test, press OCP key to the next step.

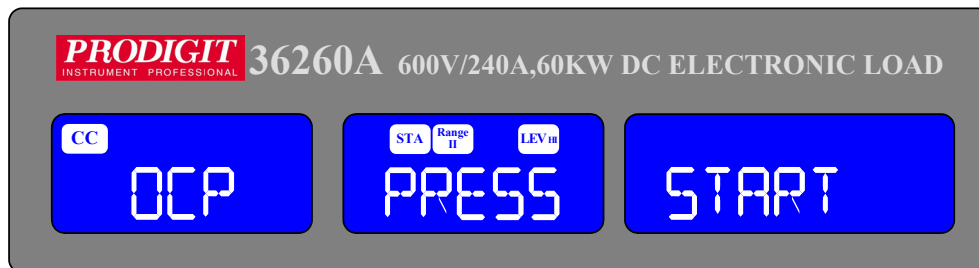

5.13.1.4. Setting start load current 0A, press OCP key to the next step.

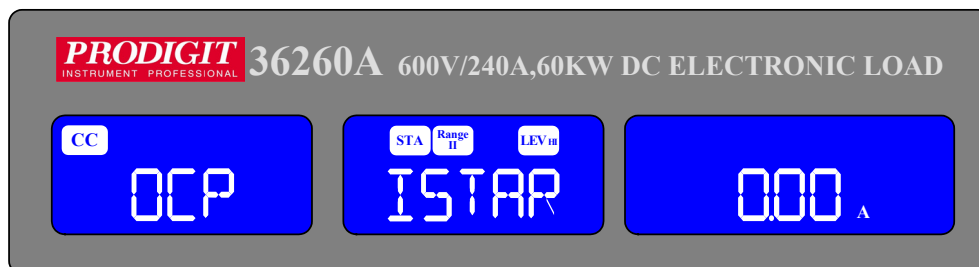

5.13.1.5. Setting step load current 0.01A, press OCP key to the next step.

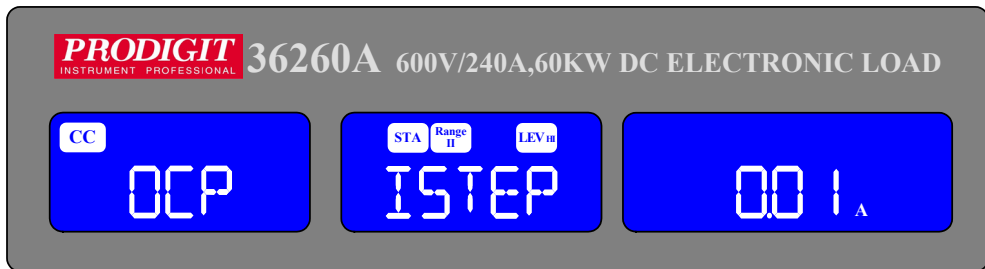

5.13.1.6. Setting stop load current 5A, press OCP key to the next step.

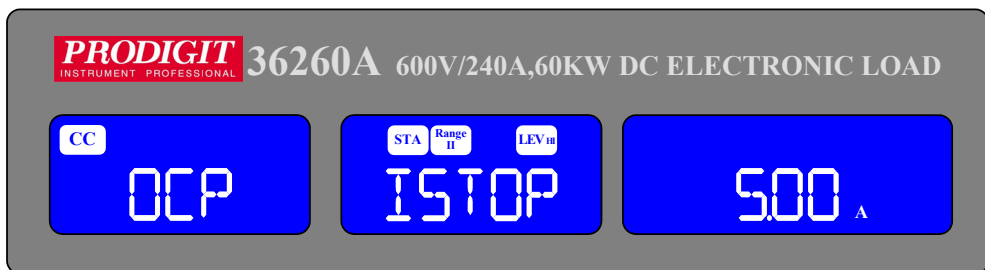

5.13.1.7. Setting OCP VTH 6.00V, press OCP key to the next step.

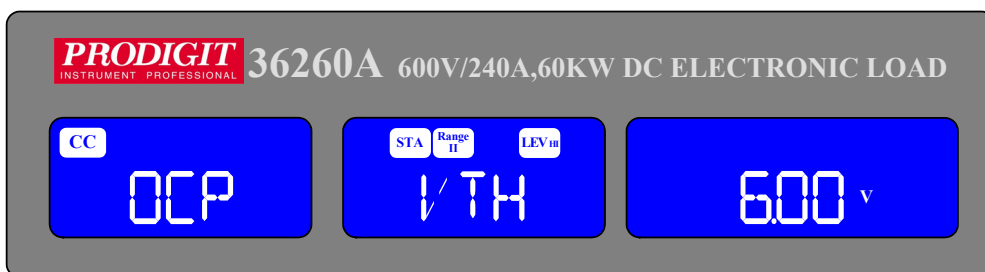

5.13.1.8. Press START/STOP test key.

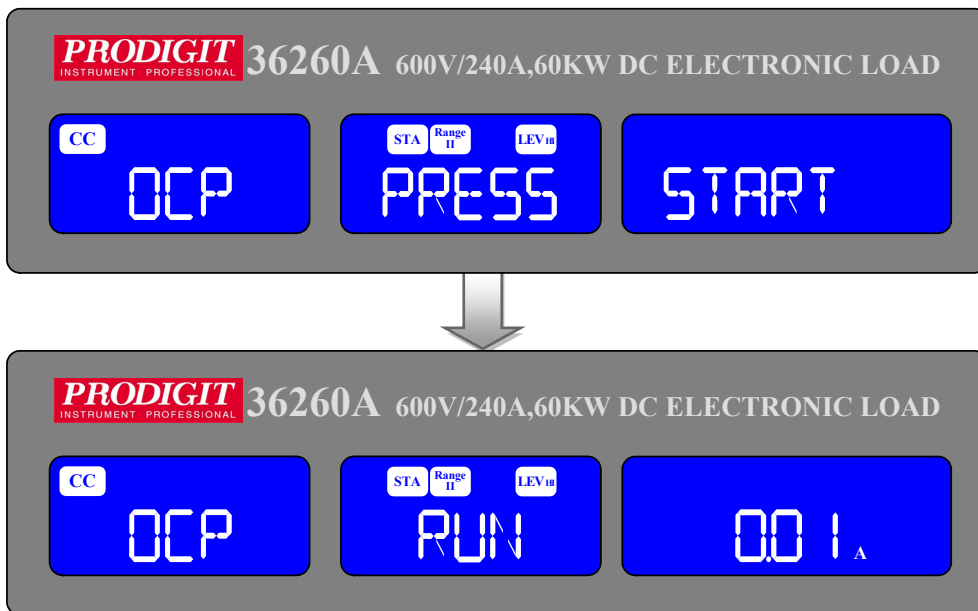

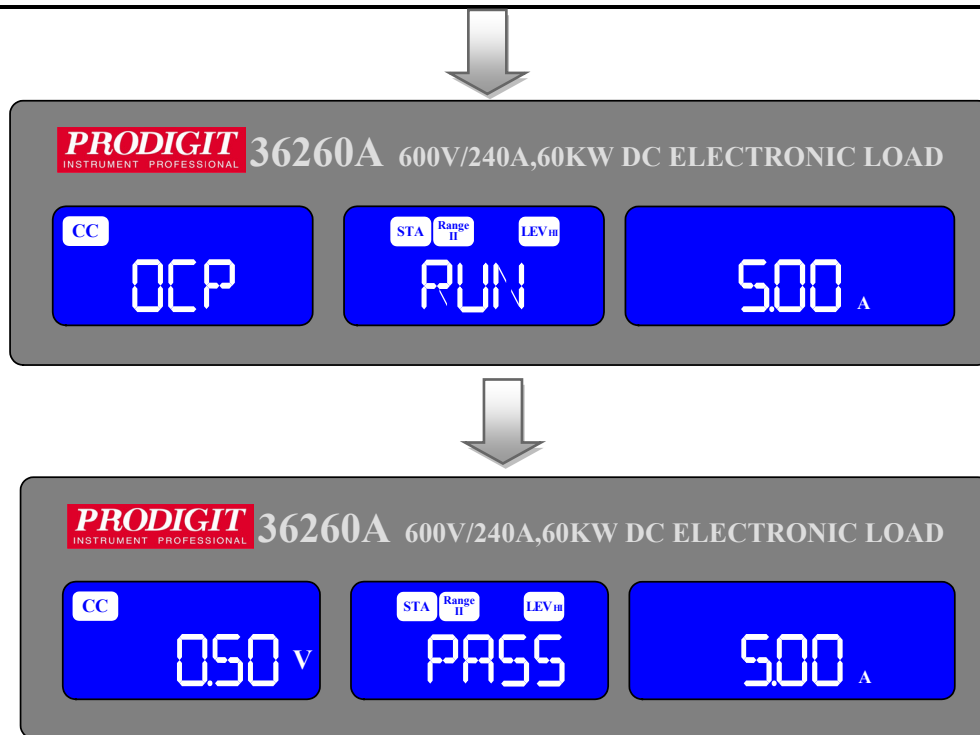

- 5.13.1.9. The UUT's output voltage drop-out lower than the threshold voltage (V-th Setting), and the OCP trip point is between I_Hi and I_Lo limitation, then Middle 5 digits LCD display will shows "PASS", otherwise shows "FAIL".

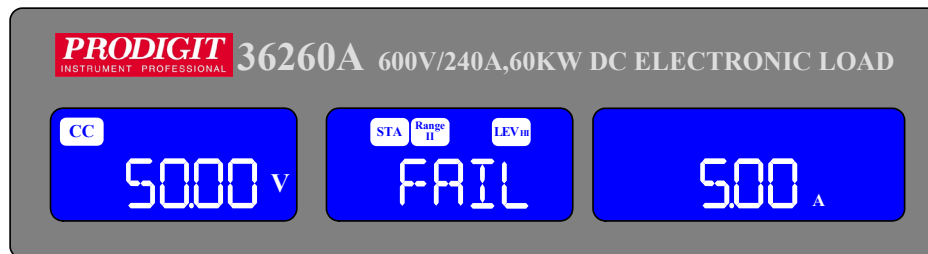

5.13.2. Remote control OCP

EX:

REMOTE	(Set Remote)
TCONFIG OCP	(Set OCP test)
OCP:START 0.1	(Set start load current 0.1A)
OCP:STEP 0.01	(Set step load current 0.01A)
OCP:STOP 2	(Set stop load current 2A)
VTH 3.0	(Set OCP VTH 3.0V)
IL 0	(Set current low limit 0A)
IH 2	(Set current high limit 2A)
NGENABLE ON	(Set NG Enable ON)
START	(Start OCP testing)
TESTING?	(Ask Testing? 1 : Testing , 0 : Testing End)
NG?	(Ask PASS/FAIL? , 0 : PASS , 1 : FAIL)
OCP?	(Ask OCP current value)
STOP	(Stop OCP testing)

5-14. Power Supply OPP testing

5.14.1. OPP Manual control

Example:

5.14.1.1. First, press Limit Key function to setting W_Hi 30.00W..

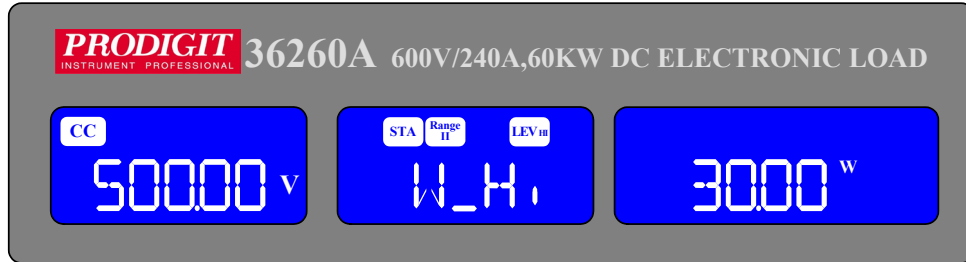

5.14.1.2. Press Limit Key function to setting W_Lo 0W..

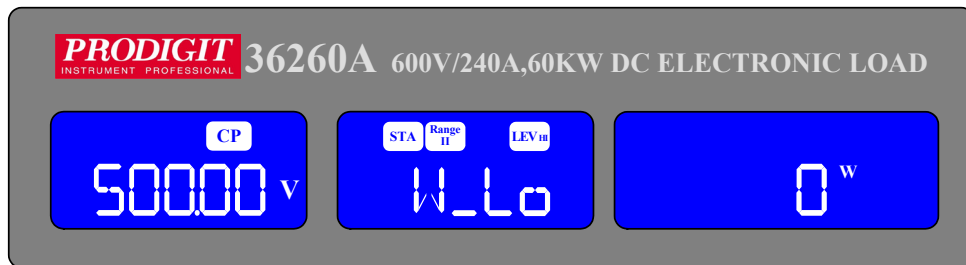

5.14.1.3. Setting OPP test, press OPP key to the next step.

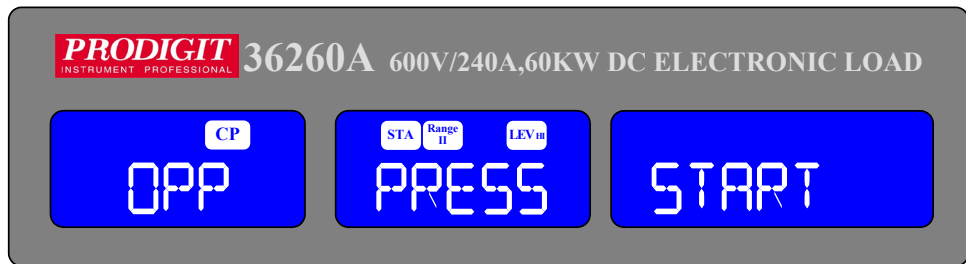

5.14.1.4. Setting start load watt 0W, press OPP key to the next step.

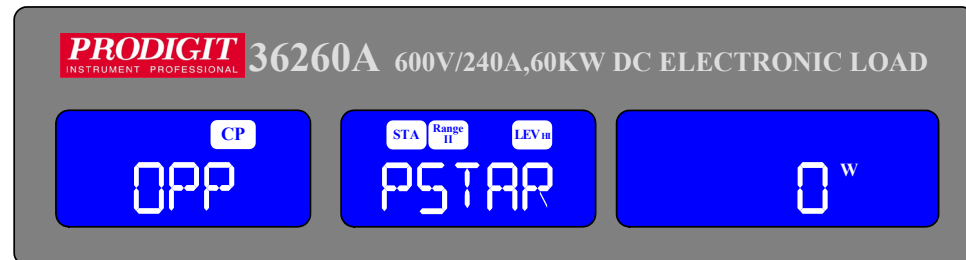

5.14.1.5. Press up key, set step load watt 5W, press OPP key to the next step.

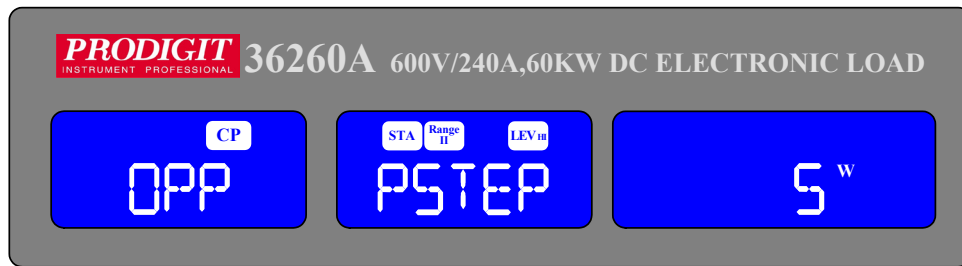

5.14.1.6. Press up key, set stop load watt 100W, press OPP key to the next step.

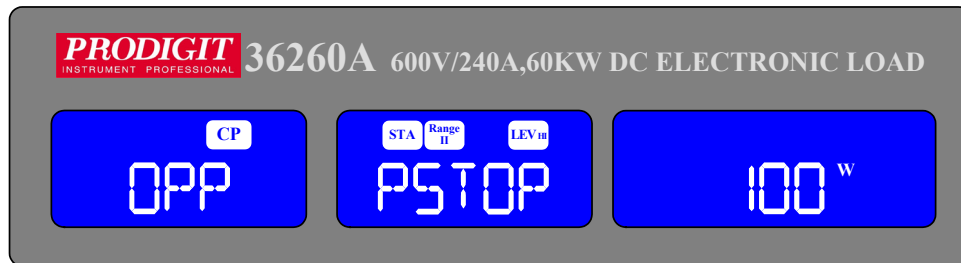

5.14.1.7. Setting OPP VTH 6.00V, press OPP key to the next step.

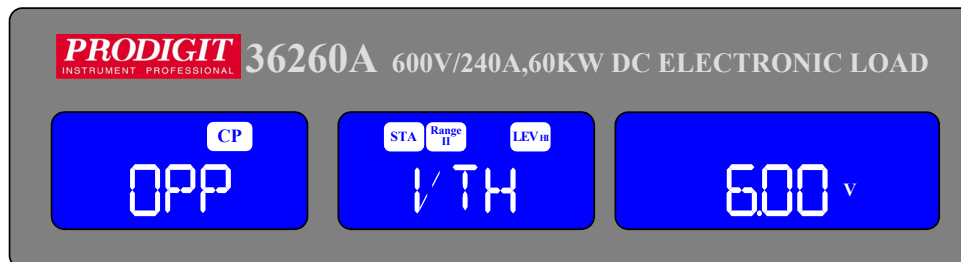

5.14.1.8. Press START/STOP Test key.

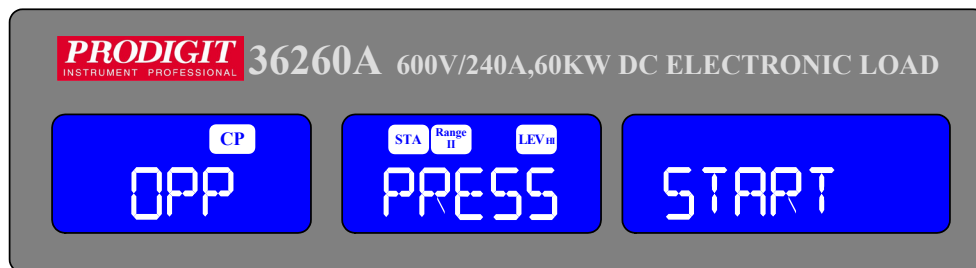

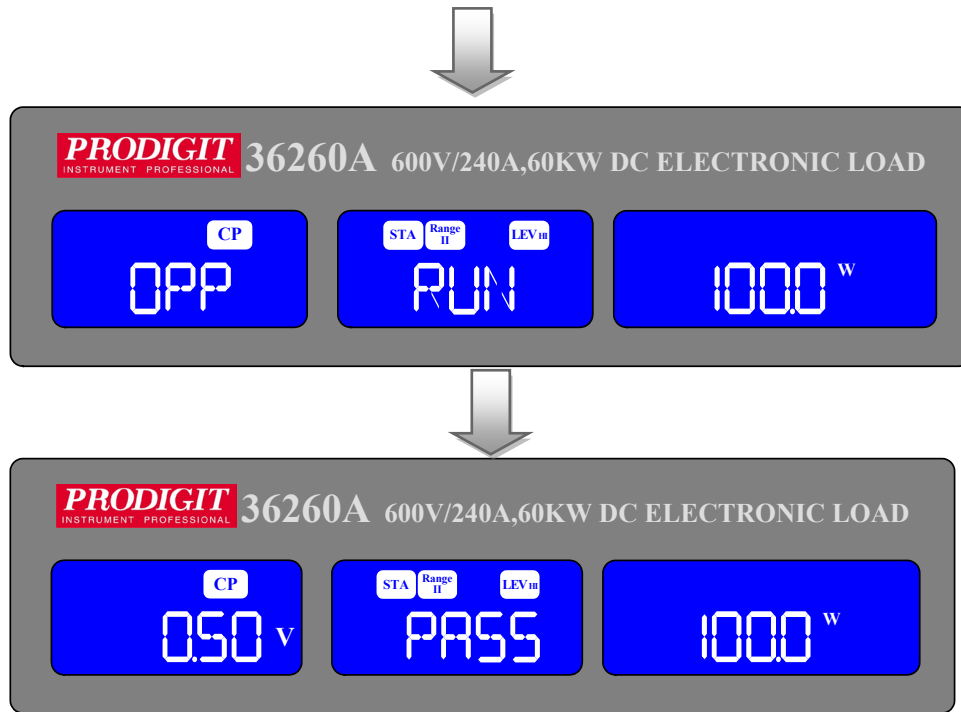

5.14.1.9. the UUT's output voltage drop-out lower than the threshold voltage (V-th setting), and the OPP trip point is between W_Hi and W_Lo limitation, then Right 5 digits LCD display will shows "PASS", otherwise shows "FAIL".

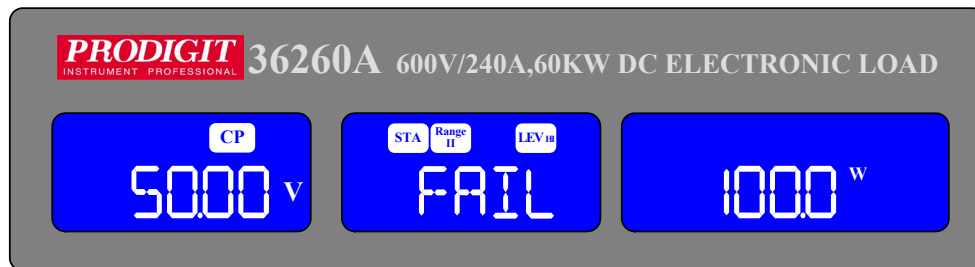

5.14.2. Remote control OPP

EX:

REMOTE	(Set Remote)
TCONFIG OPP	(Set OCP test)
OPP:START 3	(Set start load watt 3W)
OPP:STEP 1	(Set step load watt 1W)
OPP:STOP 5	(Set stop load watt 5W)
VTH 3.0	(Set OPP VTH 3.0V)
WL 0	(Set watt low limit 0W)
WH 5	(Set watt high limit 5W)
NGENABLE ON	(Set NG Enable ON)
START	(Start OPP testing)
TESTING?	(Ask Testing? 1 : Testing , 0 : Testing End)
NG?	(Ask PASS/FAIL? , 0 : PASS , 1 : FAIL)
OPP?	(Ask OPP watt value)
STOP	(Stop OPP testing)

5-15.SHORT testing

5.15.1. SHORT Manual control

Example:

5.15.1.1. Setting SHORT test, press Short key to the next step.

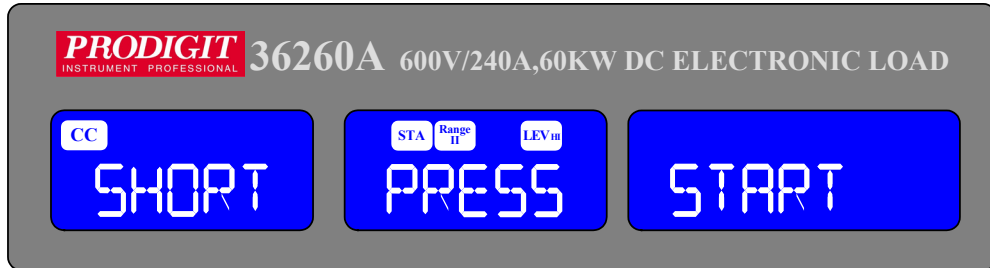

5.15.1.2. Press UP key, setting Short time to 10000ms, press Short key to The next Step.

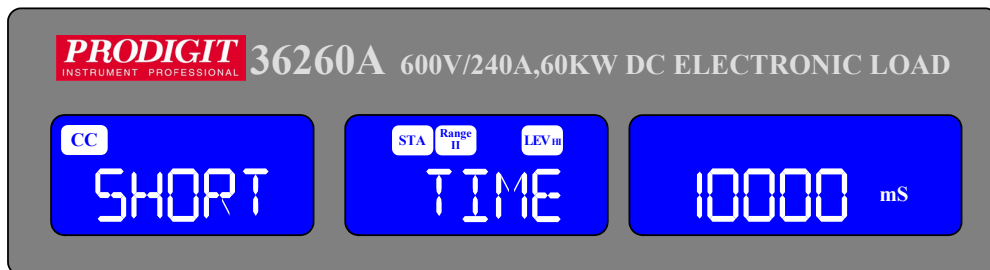

5.15.1.3. Press down key, setting V-Hi voltage to 1.00V, press Short key to the next Step.

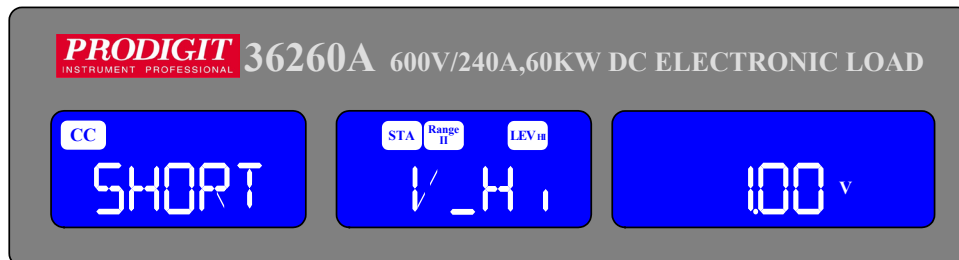

5.15.1.4. Press down key, setting V-Lo voltage to 0V, press Short key to the next Step.

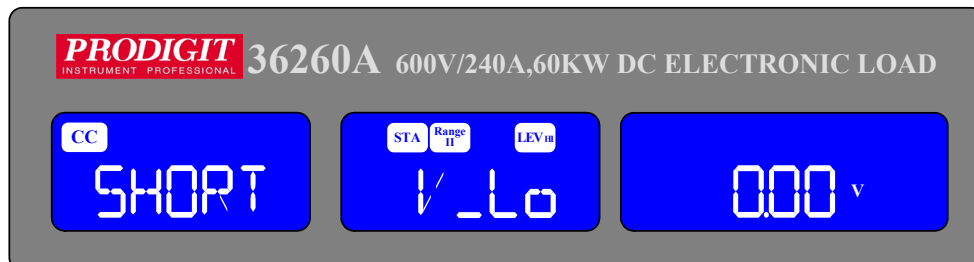

5.15.1.5. Press START/STOP test key.

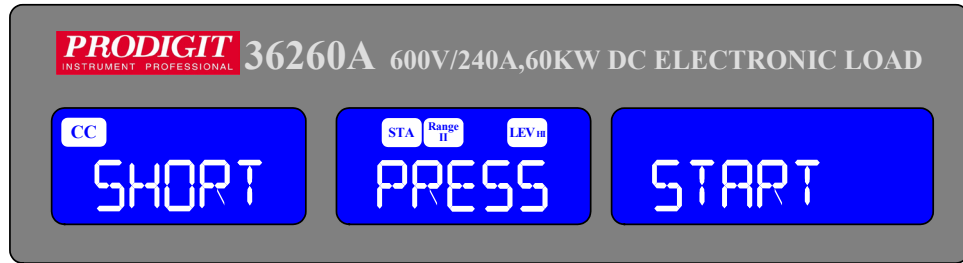

5.15.1.6. Short test finish, the UUT's drop voltage is between V_Hi and V_Lo limitation, then middle 5 digits LCD display will shows "PASS"

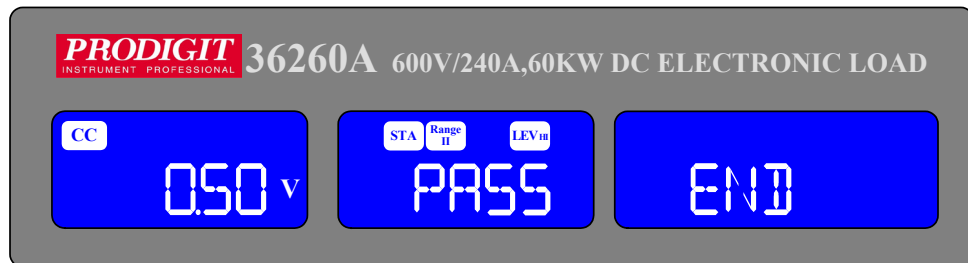

5.15.1.7. The UUT's not drop voltage is between V_Hi and V_Lo limitation, LCD display will shows FAIL.

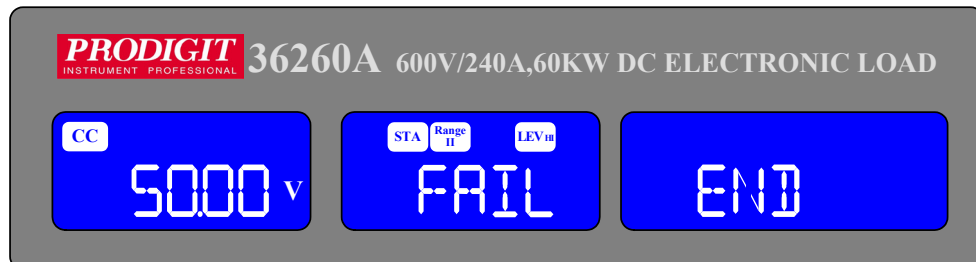

5.15.2. Remote control SHORT

EX:

REMOTE	(Set Remote)
TCONFIG SHORT	(Set SHORT test)
STIME 1	(Set short time 1ms)
START	(Start SHORT testing)
TESTING?	(Ask Testing? 1 : Testing , 0 : Testing End)
STOP	(Stop SHORT testing)

5-16. The MPPT algorithm for 36000A series DC Load

The MPPT algorithm for 36000A series DC Load

Many photovoltaic (PV) devices, such as PV panels and concentrated photovoltaic (CPV) modules, require outdoor testing for design verification, durability, and safety. A low cost means of testing the output power of PV devices outdoors is to use DC electronic load; it provides high power-handling capability at a low cost.

Often one of the main functions of outdoor PV testing is maximum power-point tracking (MPPT). But because E-loads are general-purpose instruments, it is up to the PV test engineer to implement an algorithm in test software to perform MPPT.

Fortunately, there are a lot of MPPT algorithm you can choose from, with more than 19 published papers on the implementation and performance of different MPPT algorithm. However, these algorithms were designed for solar inverters. Inverter are different fro test systems, so a MPPT algorithm that performs well in an inverter may not necessarily perform well in a PV test system. This article introduces a MPPT algorithm that is a good fit for PV testing with an E-load. We discuss how the algorithm is implemented and why it's a good fit for MPPT in outdoor PV test systems.

The main difference between implementing a given MPPT algorithm in an inverter and an E-load is in the I/O latency. In inverters, the MPPT algorithm runs on an internal microprocessor that can measure and compute and make load adjustments in microseconds. To perform the same set of operations with custom software and an E-load could easily take tens of milliseconds due to the unavoidable I/O latency between the computer and the E-load. This I/O latency is the main bottleneck affecting tracking speed. With that in mind, we chose and modified the MPPT algorithm discussed in this article to meet the needs of a PV test system using the 36000A series E-load.

An E-load is an instrument that can sink and measure the output power of a power source, such as a power supply or a PV device. Like a variable resistor, an E-load can be adjusted to control the amount of power it is sinking. E-loads can measure the voltage drop across them and the current they are sinking. E-loads typically have four modes of operation: constant current, constant resistance, constant voltage and constant power. The E-load will maintain its mode setting even when the power output of the source it is connected to changes. For instance, if the E-load is connected to the output of a PV panel and has a constant-voltage (CV) mode setting of 30V, it will adjust its internal resistance to remain at 30V as the I-V curve of the panel varies. If the maximum voltage of the panel (V_{oc}) drop below 30V, the E-load will act like an open and the voltage across it will be whatever V_{oc} is. In photovoltaic test, E-loads are typically used in CV mode, so we will use this mode for defining the algorithm.

36000A series E-LOAD MPPT algorithm

The algorithm that will be used for performing MPPT with the 36000A series E-load is a modified version of the Perturbation and Observation (P&O) algorithm, which we will refer to as the Perturbation and Observation for 36000A series load MPPT algorithm. The 36000A series load MPPT algorithm works by comparing the small perturbation values and sampling of instantaneous values of a PV device's output. These values give us the measuring change in the V-P curve to tell us if we are already at the MPP. If we are not at the MPP, it tells us which way to go on the curve to find it.

The mathematical relationships of voltage and power that 36000A series uses to track the MPP can be expressed as:

$$\text{At MPP : } P_n - P_{n-1} = 0$$

Right of MPP : $P_n - P_{n-1} > 0$ and $V_n - V_{n-1} < 0$, $P_n - P_{n-1} \leq 0$ and $V_n - V_{n-1} \geq 0$

Left of MPP : $P_n - P_{n-1} \leq 0$ and $V_n - V_{n-1} < 0$, $P_n - P_{n-1} > 0$ and $V_n - V_{n-1} \geq 0$

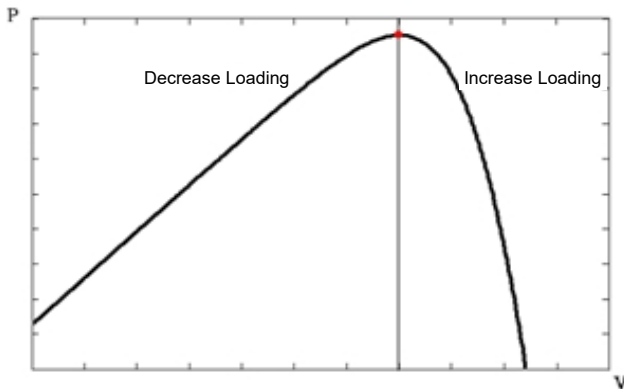

$P_n - P_{n-1} > 0$	$V_n - V_{n-1} \geq 0$	Location	Tracking Load
False	False	Left	Decrease
False	True	Right	Increase
True	False	Right	Increase
True	True	Left	Decrease

How to operating MPPT in 36000A series load

Manual Operation:

Press "Config" key 5 times to MPPT function and the initial tracking interval time is 2000mS than press "Start/Stop" key to going to track the MPP(The operation mode will be goes to CV mode and Load ON automatically.)

1. Power ON 36000A series Load
2. Connecting UUT (PV panel) to load input terminal
3. Press "Config" 5 times to MPPT function
4. Adjust the interval time (Initial is 2000mS) by adjust key(every 2000mS record a voltage, current and power data in the internal memory, that can be record about 720 data, The MPP tracking will be stop when memory is full. The memory data will be clear when power OFF)
5. Press Start/Stop to start tracking MPP of UUT
6. The voltage, current and power (MPP) will display on the meter of 36000A series load.
7. Press Start/Stop to stop to tracking the MPP of UUT. Or the record memory is full.

5-17. Battery discharge test

36000A Series battery discharge test, a total of five types:

5.17.1. TYPE 1:

When testing loads on of Constant current (CC) mode, When battery voltage is less than UVP (under voltage protect) setting values, The LED is off to indicate Load off status, and displays the total discharge stored energy of the AH as fig 5-15 shows.

Note: When the remote control, the panel does not show the total discharge capacity.

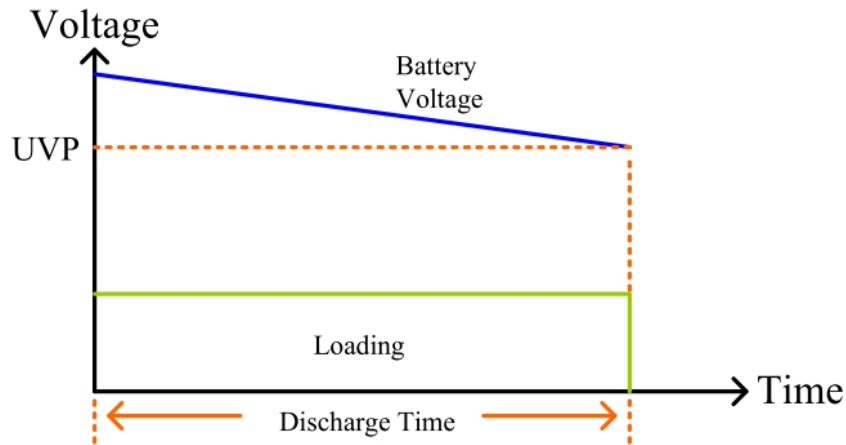

Fig 5-13 TYPE 1 Battery Discharge Figure

5.17.2. TYPE2:

When testing loads on of Constant current (CC) mode, battery voltage is less than UVP Setting values, Constant current (CC) mode auto change to Constant voltage (CV) mode as Fig 5-14 shows.

(CV values =UVP setting values).

Note: When CC or CP is converted to CV, there will be a small hardware switching time, Causing the stop to load on. If you do not want to interrupt, refer to 5-7 CV+Current limit mode or 5-8 CV+Power limit mode.

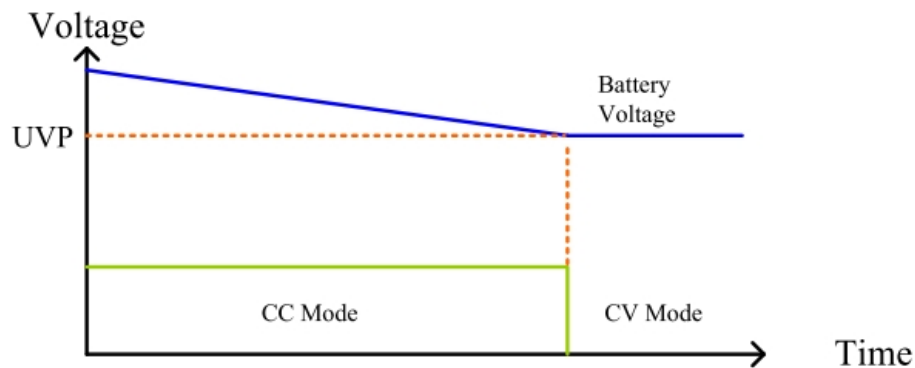

Fig 5-14 TYPE 2 Battery Discharge Figure

5.17.3. TYPE 3:

When testing loads on of Constant current (CC) mode, setting discharge Time, when Load on time achieve setting time, this moment load on auto change to load off and Display voltage, setting Timer value range 1 to 99999 sec (27H).

Note: Pre-setting the LOAD OFF voltage can protect the battery from discharging when The preset discharge time has not been reached, and stop the battery when the battery Voltage is to low to avoid battery damage.

5.17.4. TYPE 4:

Cycle Life test, Battery discharge test use pulse mode, Dynamic mode use count test And Repeat function, as show Fig 5-17, load on and dynamic on until counter to 0, load On and dynamic on auto change to off, Remote will shows "OK" and XX.XXX"(V meter), Cycle setting range 1 to 2000, step setting value 1 to 3 and Repeat setting value 0 to 9999, the setting is by remote operation.

Note: Pre-setting the LOAD OFF voltage can protect the battery from discharging when The preset discharge time has not been reached, and stop the battery when the battery Voltage is to low to avoid battery damage.

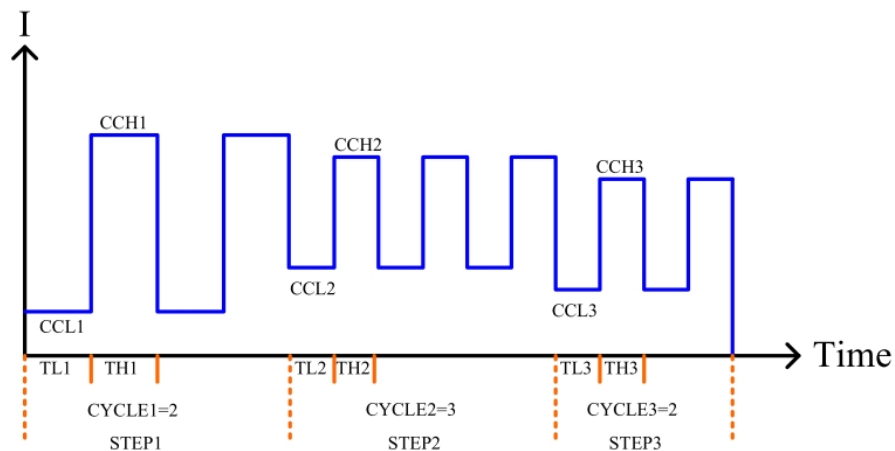

Fig 5-15 TYPE 4 Battery Discharge Figure

5.17.5. TYPE 5:

RAMP Mode, Slew rate load on and Repeat function, as Fig 5-16 Show. Setting" STEPn" n-1~9, CC0, CC1, $\Delta T1$, CC2, $\Delta T2$CC9, $\Delta T9$, Repeat, Load on mode, Increased or Decreased current values by every seconds.

$\Delta CC = (CC_n - (CC_{n-1})) / \text{Time}$, Time: 0~6000Sec, STEP: 1~9, Repeat: 0~9999, Load on Auto change to off and remoter will shows "OK" and XX.XXX"(V meter).

Note: Pre-setting the LOAD OFF voltage can protect the battery from discharging when The preset discharge time has not been reached, and stop the battery when the battery Voltage is to low to avoid battery damage.

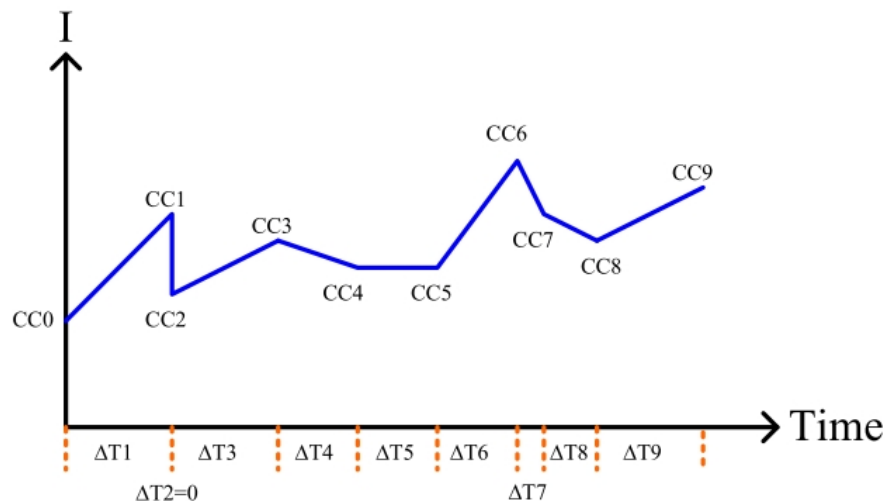

Fig 5-16 TYPE 4 Battery Discharge Figure

- 5.17.6. CV+Current limit: Refer to Chapter 5-7 for the operation mode.
- 5.17.7. CV+Power limit: Refer to Chapter 5-8 for the operation mode.
- 5.17.8. Operation : Type 1 to 3 is manual operation or remote operation.
Type 4 to 5 the only Remote operation.

Manual Instructions:

5.17.8.1. Type 1:

When testing loads on of Constant current (CC) mode, Press Config key to Batt1, Setting parameters Middle LCD text will show "BATT1, It is TYPE 1. Right LCD text Will show "UVP", adjustment UVP value, Press START Key to start the test at this Time automatic load on, right LCD text will accumulate the Discharge capacity, unit: AH (ampere-hour), When the battery Voltage less than the UVP value, Load off Test End. Right LCD will display total discharge capacity, if you press the START key will Retest or press any key to exit test status.

5.17.8.2. Type 2:

When testing loads on of Constant current (CC) mode, Press Config key to Batt2, Setting parameters Middle LCD text will show "BATT2, It is TYPE 2. Right LCD text Will show "UVP", adjustment UVP value, Press START Key to start the test at this Time automatic load on; Right LCD text will accumulate the discharge capacity, Unit: AH (ampere-hour), When the battery Voltage is less than the UVP value, CC Mode automatic change to CV mode keep load on and exit test status.

5.17.8.3. Type 3:

When testing loads on of Constant current (CC) mode, Press Config key to Batt3, Setting parameters Middle LCD text will show "BATT3, It is TYPE 3. Right 5 digit LCD Display will show "Time", adjustment time value, Press START Key to start the test At this time automatic LOAD ON, Right 5 digit LCD display will accumulate the Discharge capacity, when load on time achieve setting time, this moment Load on Auto change to load off, Right 5 digit LCD display will show End Voltage. If you Press The START key will retest or press any key to exit.

5.17.9. REMOTE Command Description:

5.17.9.1. Type 1:

Set TYPE 1, and Set CC mode load on and set UVP Value command input "BATT: TEST ON", Command to start the test, When the battery Voltage less than The UVP value, load off test end and remoter will shows "OK, XXXXX", XXXXX The total discharge capacity: AH.

Example:

```
BATT: TYPE 1
CC: HIGH 2.34
BATT: UVP 12.0
BATT: TEST ON
```

5.17.9.2. Type 2:

Set TYPE 2, and Set CC mode load on and set UVP Value command input "BATT: TEST ON", Command to start the test, When the battery Voltage less than The UVP value, CC mode automatic change to CV mode keep load on and exit test Status, remoter will show "OK, XXXXX", XXXXX is total discharge capacity: AH.

Example:

```
BATT: TYPE 2
CC: HIGH 2.34
BATT: UVP 12.0
BATT: TEST ON
```

5.17.9.3. Type 3:

Set TYPE 3, and Set CC mode load on and set discharge Time Value command input "BATT: TEST ON", Command to start the test, When the discharge Time achieve The Set value, load off test end, remoter will show "OK, XXXXX", XXXXX is Discharge end Voltage.

Example:

```
BATT: TYPE 3
CC: HIGH 2.34
LDOFFV 10.5
BATT: TIME 6000
BATT: TEST ON
```

5.17.9.4. Type 4:

Set TYPE 4, and The set sequence is CCLn/CCHn/THn/TLn/CYCLEn, Repeat Parameters command input "BATT: TEST ON", Command to start the test, Test end, Remoter will show "OK, XXXXX", XXXXX is end Voltage.

Example:

```
BATT: TYPE 4
BATT: STEP 2
BATT: CCH1 6.0
```

BATT: CCL1 1.0
BATT: TH1 2.0
BATT: TL1 2.0
BATT: CYCLE1 500
BATT: CCH2 4.0
BATT: CCL2 1.0
BATT: TH1 1.0
BATT: TL1 1.0
BATT: CYCLE2 500
LDOFFV 10.5
BATT: REPEAT 1
BATT: TEST ON

5.17.9.5. Type 5:

Set TYPE 5, and The setting sequence is CCLn/CCHn/THn/TLn/CYCLEn, Repeat Parameters command input "BATT: TEST ON", Command to start the test, Test end, Remoter will show "OK, XXXXX", XXXXX is end Voltage.

Example:

BATT: TYPE 5
BATT: STEP 3
BATT: CC0 1
BATT: CC1 3
BATT: DTIME1 1
BATT: CC2 6
BATT: DTIME2 0
BATT: CC3 4
BATT: DTIME3 2
LDOFFV 10.5
BATT: REPEAT 10
BATT: TEST ON

Appendix A GPIB programming Example

C Example Program

```

/* Link this program with appropriate *cib*.obj. */

/* This application program is written in TURBO C 2.0 for the IBM PC-AT compatible. The National
Instruments Cooperation (NIC) Model PC-2A board provides the interface between the PC-AT and a
PRODIGIT MPAL ELECTRONIC LOAD. The appropriate *cib*.obj file is required in each program to
properly link the NIC board to C LANGUAGE. and include the <decl.h.> HEADER FILE to C
LANGUAGE. */

#include <stdio.h>
#include <dos.h>
#include <math.h>
#include "decl.h"    /* NI GPIB CARD HEADER FILE */

main()
{
    char ouster[20],rdbuf[15],spec[10];
    int i,ch,load;
/* Assign unique identifier to the device "dev5" and store in variable load. check for error. ibfind error =
negative value returned. */
    if((load = ibfind("dev5")) < 0)    /* Device variable name is load */
    {
        /* GPIB address is 5 */
        printf("\r*** INTERFACE ERROR ! ***\a\n");
        printf("\r\nError routine to notify that ibfind failed.\n");
        printf("\r\nCheck software configuration.\n");
        exit(1);
    }
/* Clear the device */
    if((ibclr(load)) & ERR);
    {
        printf("INTERFACE ERROR ! \a");
        exit (1);
    }
    clrscr();
/* Clear load error register */
    {
        outstr=chan[0];
        ibwrt(load,outstr,6);
        ibwrt(load,"CLR",3);
    }
}

```

```
    ibwrt( load,"NAME?",5);                                /* Get the 36000A series load specification */
    strset(rdbuf,'\0');                                   /* Clear rdbuf string buffer */
    strset(spec,'\0');                                   /* Clear spec string buffer */
    ibrd(load,spec,20);
    if (spec[3] == '9')
        printf("\n 36000A series specification error !");
/* Set the channel 1, preset off, current sink 1.0 amps and load on commands to the load. */
ibwrt( load,"chan 1;pres off;curr:low 0.0;curr:high 1.0;load on ",43);
ibwrt( load,"meas:curr ?",10);
/* Get the load actually sink current from the load */
ibrd( load,rdbuf,20);
/* go to local. */
ibloc(load);
}
```

BASICA Example Program

LOAD DECL.BAS using BASICA MERGE command.

```
100 REM You must merge this code with DECL.BAS
105 REM
110 REM Assign a unique identifier to the device "dev5" and store it in variable load%.
125 REM
130     udname$ = "dev5"
140     CALL ibfind (udname$,load%)
145 REM
150 REM Check for error on ibfind call
155 REM
160     IF load% < 0 THEN GOTO 2000
165 REM
170 REM Clear the device
175 REM
180     CALL ibclr (load%)
185 REM
190 REM Get the 36260 load specification
195 REM
200     wrt$ = "NAME?" : CALL ibwrt(load%,wrt$)
210     rd$ = space$(20) : CALL ibrd(load%,rd$)
215 REM
220 REM Set the preset off, current sink 1.0 amps and load on commands to the load.
225 REM
230     wrt$ = "pres off;curr:low 0.0;curr:high 1.0;load on"
240     CALL ibwrt(load%,wrt$)
245 REM
250 REM Get the load actually sink current from the load
255 REM
260     wrt$ = "meas:curr?" : CALL ibwrt(load%,wrt$)
270     rd$ = space$(20) : CALL ibrd(load%,rd$)
275 REM
280 REM Go to local
285 REM
290 CALL ibloc(load%)

2000 REM Error routine to notify that ibfind failed.
2010 REM Check software configuration.
2020 PRINT "ibfind error !" : STOP
```

Appendix B 36000A series USB Instruction

1. Install the USB DRIVER select USB\SETUP\PL-2303 Driver Installer.exe

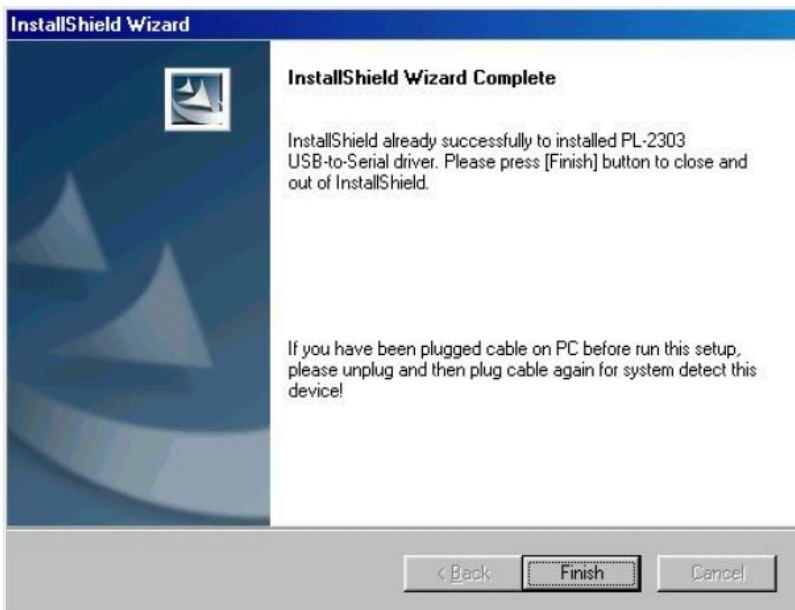
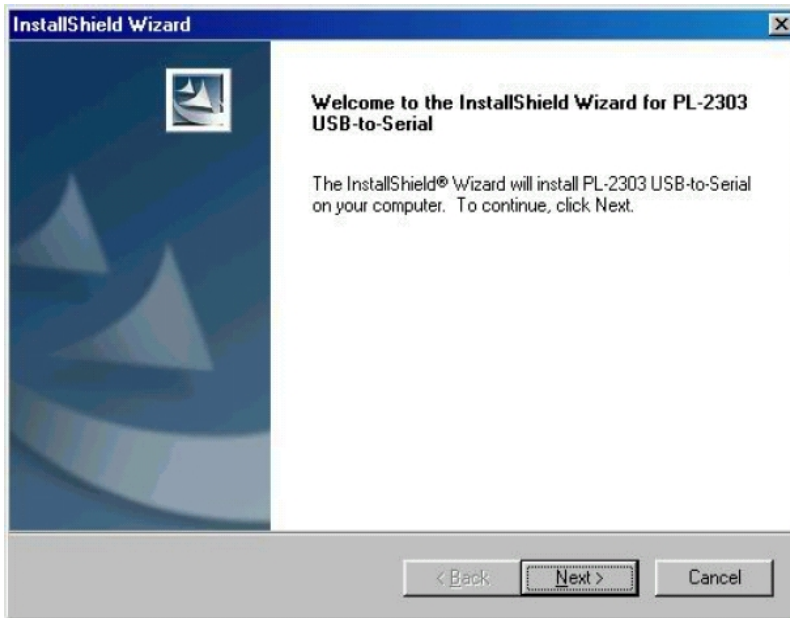

2. After the installation, connect the 36000A series and PC with USB. Then select the item USB to Serial Port (COM3), set the BAUD-RATE and Flow control to 115200bps and Hardware to control 36000A series with COM3.

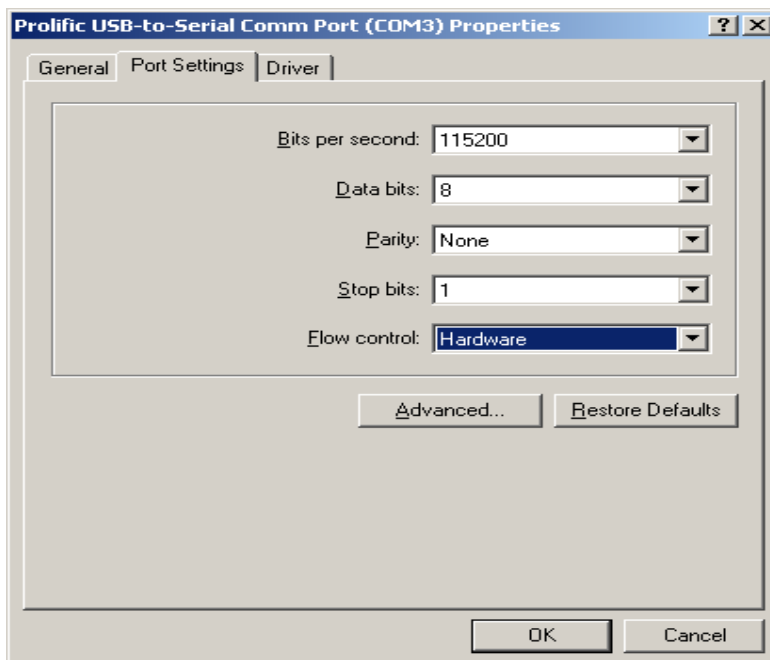
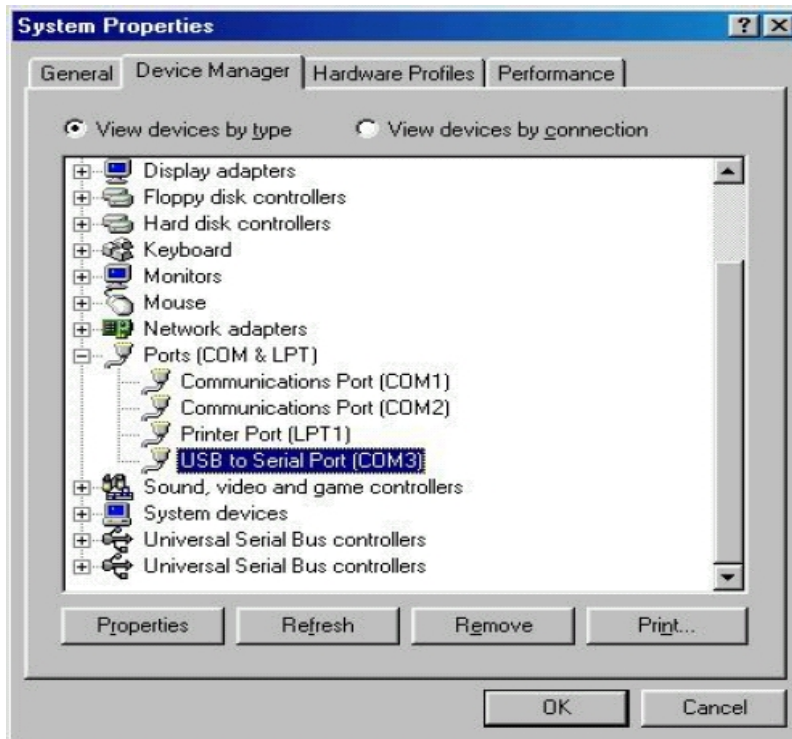

Appendix C 36000A series LAN Instruction

1. Connecting AC power and the network line to the 36000A series mainframe, connect the other Side of the network line to the HUB.
2. Run the ETM.EXE which bellows the path of the LAN on the CDROM drive, it will show as fig D2-1 if not , please press F5 to search again, or check the first step was succeed or not.

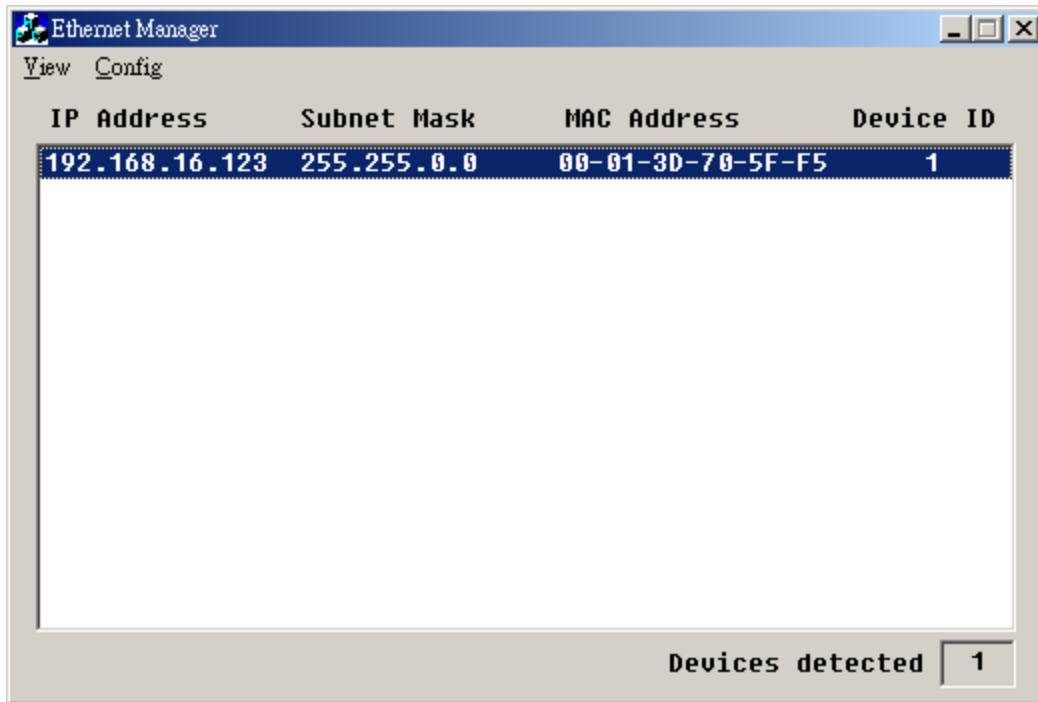
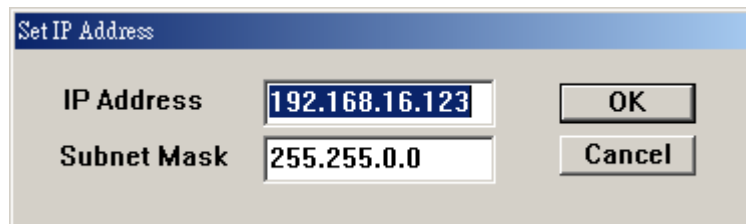

FIG D2-1

3. It will be shown the installation which has been searched on the screen , click it and select the Set IP Address bellows Config :



4. Set a useful IP Address and Subnet Mask.

5. It will be shown the Setup Device as the following figure if all steps was corrected to be run.

Controller Setup	
IP address	192.168.16.128
Subnet mask	255.255.255.0
Gateway address	0.0.0.0
Network link speed	Auto
DHCP client	Enable
Socket port of HTTP setup	80
Socket port of serial I/O	4001 TCP Server
Socket port of digital I/O	5001 TCP Server
Destination IP address / socket port (TCP client and UDP) Connection	0.0.0.0 0 Auto
TCP socket inactive timeout (minutes)	0
Serial I/O settings (baud rate, parity, data bits, stop bits)	115200 N 8 1
Interface of serial I/O	RS 232 (RTS/CTS)
Packet mode of serial input	Disable
Device ID	1
Report device ID when connected	Disable
Setup password	
Update	

6. Insert the numbers as the following :

- 6.1 IP Address: as recommended according to your network
- 6.2 Subnet Mask: as recommended according to your network
- 6.3 Gateway Address: as recommended according to your network
- 6.4 Network link speed: Auto
- 6.5 DHCP client: Enable
- 6.6 Socket port of HTTP setup: 80
- 6.7 Socket port of serial I/O: 4001 , TCP Server
- 6.8 Socket port of digital I/O: 5001 , TCP Server
- 6.9 Destination IP address / socket port (TCP client and UDP) Connection: Auto
- 6.10 TCP socket inactive timeout(minutes) : Set the network disconnection after N minutes, set 0 minutes will work forever.
- 6.11 Serial I/O settings (baud rate, parity, data, bits, stop bits): 115200, N, 8, 1
- 6.12 Interface of serial I/O: RS 232 (RTS/CTS)
- 6.13 Packet mode of serial input: Disable
- 6.14 Device ID : 5
- 6.15 Report device ID when connected : Auto
- 6.16 Setup password: Not required

Appendix D 36000A series Auto. Sequence function provide EDIT, ENTER, EXIT, TEST and STORE 5 keys operation.

Edit mode

1. Set mode, Range, current level ... Load Setting an, Load ON
2. Press STORE key to store the load setting in memory STATE
3. Repeat 1~2, for the sequence load setting.
4. Press Shift + SEQ. key of 36000A series front panel.
5. Press up/down key to select Edit Mode.
6. Press 1~9 number key program number.
7. Press STATE up/down key to select memory state.
8. Press ENTER to next step.
9. Repeat 6~8 to edit Step of sequence
10. Press SAVE to confirm the step
11. LCD shows "rept" to setting repeat count.
12. Press up/down key to set repeat count of sequence loop.
13. Press ENTER to confirm the sequence edit.

Test mode

1. Press Shift + SEQ. key of 36000A series front panel.
2. Press up/down key to select Test Mode.
3. Press 1~9 number to select sequence number
4. Press ENTER to execution the sequence
5. The LCD shows "PASS" or "FAIL" after testing.

AUTO SEQUENCE:

AUTO SEQUENCE SET COMMAND	NOTE	RETURN
FILE {SP} {n}{ ; NL}	n=1~9	1~9
STEP {SP} {n} { ; NL}	n=1~16	1~16
TOTSTEP {SP} {n}{ ; NL}	Total step n=1~16	1~16
SB {SP} {m} { ; NL}	m=1~150 m:STATE	
TIME {SP} {NR2} { ; NL}	100~9999(ms)	100~9999(ms)
SAVE { ; NL}	Save "File n" data	
REPEAT {SP} {n} { ; NL}	n=0~9999	0~9999
RUN {SP} {F} {n} { ; NL}	N=1~9	AUTO REPLY "PASS" or "FAIL:XX" (XX=NG STEP)

Example Sequence

In this example, we will create a program based on following Figure.

The program repeats steps 1 to 8 two times. After repeating the sequence two times, the load is turned off and the sequence ends.



Sequence Number	Step Number	Current Value	Execution Time(T1+T2)
3	1	1A	200mS
3	2	5A	200mS
3	3	1A	400mS
3	4	5A	400mS
3	5	1A	200mS
3	6	10A	200mS
3	7	1A	200mS
3	8	0A	200mS

Creating the program

- Setting the Load current level and store to state 1~8
- Set the operation mode
Press the mode key to CC mode.
- Set the range
Press RANGE key to force range 2
- Press Load ON
- Set the current value as step 1~8 and store to memory state 1~8
- Press EDIT key of 36000A series mainframe
- Press up/down key to select Edit Mode
- Press sequence number 3 to edit the sequence
- Press up/down key to memory state 1
- Press ENTER key to confirm the sequence memory
- Press up/down key to setting execution time
- Press ENTER key to confirm the sequence step
- Repeat 8~12 to setting step 1~8
- Press SAVE key to confirm step 1~8
- Press up/down key to 1 to repeat one times.
- Press ENTER to confirm the repeat count.

