



PCS-1000I

Isolated Output High Precision Current Shunt Meter

FEATURES

- 6 1/2 Digit Voltage and Current Measurement Resolution
- Simultaneous Current and Voltage Measurement
- Five Current Measurement Levels (AC & DC) : 30mA/300mA/3A/30A/300A
- AC Voltage Measurement Levels : 200mV/2V/20V/200V/600V
- DC Voltage Measurement Levels : 200mV/2V/20V/200V/1000V
- Standard : USB & GPIB
- CE Verification

GW INSTEK
Simply Reliable

GW Instek rolls out the new PCS-1000I isolated output high precision current shunt meter, which inherits the simultaneous voltage and current measurement function of PCS-1000. PCS-1000I adopts five sets of independent shunt resistors to provide five current measurement levels, including 300A, 30A, 3A, 300mA, and 30mA to meet the requirements of different current level measurements. Internally, PCS-1000I utilizes two sets of 24bits ADCs and low temperature coefficient electronic components to mainly focus on the current measurement of power supply devices. High precision PCS-1000I can be used in adjusting and calibrating instruments. Additionally, temperature variation will not cause PCS-1000I to yield any measurement errors. PCS-1000I can automatically select optimal measurement level with the maximum resolution so as to replace manual selection to save operational time.

PCS-1000I provides a BNC output, which can connect with an oscilloscope to directly observe current waveform variation without using a current probe. General oscilloscopes do not have isolated channels and their input and output are structured at a common point, therefore, the output load will likely result in measurement errors. PCS-1000I's isolated current output design can prevent measurement errors from an oscilloscope with non-isolated outputs. PCS-1000I, a high precision AC/DC current shunt meter, not only provides USB and GPIB communications interfaces for users to remotely control the instrument but also conducts simultaneous voltage and current measurements. The SCPI communications commands of PCS-1000I allow users to remotely control PCS-1000I via a PC to operate measurement data readbacks.

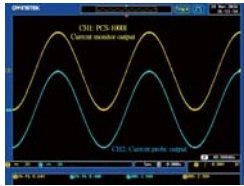

PCS-1000I vs. Current Probe for Measurement

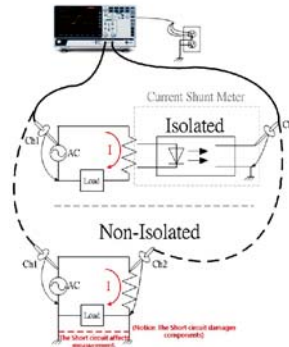

The measurement issue for Non-Isolated Shunt meter

A. SIMULTANEOUS VOLTAGE AND CURRENT MEASUREMENT

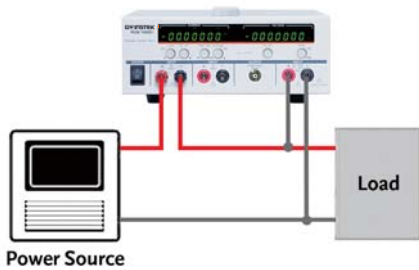

PCS-1000I high precision AC and DC shunt meter can simultaneously measure current and voltage with the maximum 6 1/2 measurement resolution. The above diagram shows the connection method of simultaneous measurement. Compared with the test of conventional meters from other brands, PCS-1000I is simple in connection and there is no requirement of any additional instrument.

B. FIVE SETS OF SHUNT RESISTORS TO SWITCH MEASUREMENT



The switching measurement of five independent shunt resistors provides excellent resolution than that of a single shunt resistor. Under 30mA range, the resolution is 0.01uA, which is ideal for very small current measurement.

C. REMOTE CONTROL APPLICATION

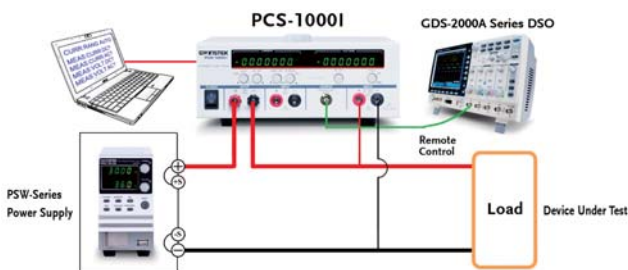

PCS-1000I is not only a high precision AC/DC shunt meter but also provides users with USB and GPIB communications interface so as to remotely control operational sequence. The SCPI commands of PCS-1000I allow users to read back measurement value via a computer remotely controlling PCS-1000I. As shown on the above diagram, the series connection between PCS-1000I and DUT and the parallel connection between voltage input and DUT are arranged to conduct simultaneous voltage and current measurement on DUT. Via the connection between communications and a notebook computer, PCS-1000I can be remotely controlled by operating the notebook computer and edited sequence.

D. ISOLATED OUTPUT CURRENT OUTPUT DESIGN

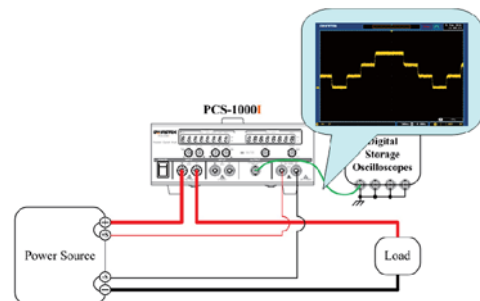

PCS-1000I adopts isolated current output design. Its BNC output can directly connect with an oscilloscope to avoid measurement errors resulted from the common ground of oscilloscope's analog input measurement.

E. AUTOMATIC RANGE-SWITCHING MEASUREMENT FUNCTION



Press and hold Auto key, PCS-1000I will automatically select the maximum measurement resolution for users to save time in manual selection.

F. CONNECTION COMPARISON

PCS-1000I can simultaneously measure current and voltage with 6 1/2 measurement resolution. The left diagram shows the connection method of simultaneous measurement. Compared with the test of conventional meters from other brands, PCS-1000I is simple in connection and there is no requirement of any additional instrument.

PCS-1000i Conducts Simultaneous Voltage and Current Measurement

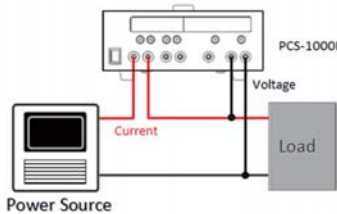

1. Only one PCS-1000I is needed to measure voltage and current
2. Easy connection
3. USB and GPIB communications on the rear panel can be used for data communication while connecting with a PC

Shunt Resistor Conducts Current and Voltage Measurement

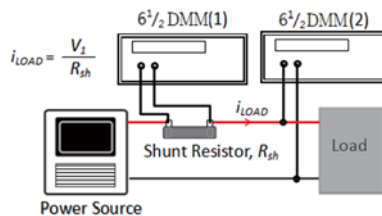

1. One voltage meter is needed to measure voltage on shunt and the voltage will be converted to current. For simultaneous voltage and current measurement, one extra voltage meter is required
2. Complex connection
3. For data communication with a PC, the PC must be connected to two voltage meters

Conventional Shunt Meter Conducts Current and Voltage Measurement

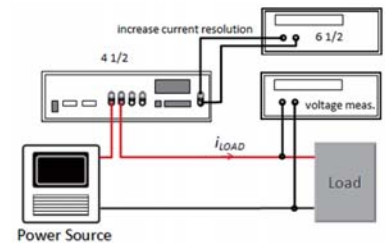

1. This method requires one shunt meter, one current meter to increase current measurement resolution, and one voltage meter to measure voltage
2. Complex connection
3. For data communication with a PC, the PC must be connected to two meters

PANEL INTRODUCTION



1. Power Switch
2. AC/DC 30A Terminal
3. AC/DC 3A/300mA/30mA Terminal
4. Current Monitor Sensor
5. AC/DC Voltage Terminal
6. Range for Voltage/Enter/Auto
7. AC/DC current range
8. Local/Function
9. Display
10. Power Cord Socket
11. GPIB
12. USB
13. AC/DC 300A Terminal
14. Fan

SPECIFICATIONS

DC CHARACTERISTICS	DC Voltage	Range	1 Year 23 °C ± 5 °C	Temperature Coefficient/°C	
		200.0000 mV	0.0050 + 0.0035	0.0005 + 0.0005	
		2.000000 V	0.0050 + 0.0010	0.0005 + 0.0001	
		20.00000 V	0.0050 + 0.0010	0.0005 + 0.0001	
		200.0000 V	0.0050 + 0.0010	0.0005 + 0.0001	
	1000.000 V	0.0050 + 0.0020	0.0005 + 0.0001		
	Accuracy specification : ±(% of reading + % of range);voltage input resistance: 10MΩ for all DC voltage ranges				
	DC Current	Range	Burden Voltage	1 Year 23 °C ± 5 °C	Temperature Coefficient/°C
		30.00000 mA	< 0.4 V	0.01 + 0.005	0.001 + 0.002
		300.0000 mA	< 0.5 V	0.01 + 0.005	0.001 + 0.002
3.000000 A		< 0.8 V	0.01 + 0.005	0.001 + 0.002	
30.00000 A ^{*1}		< 0.8 V	0.01 + 0.005	0.001 + 0.002	
300.0000 A ^{*1}	< 0.8 V	0.02 + 0.005	0.001 + 0.002		
Accuracy specification : ± (% of reading + % of range)					
Isolated DC Current Monitor Accuracy	Range	Resolution(6 1/2)	DC Accuracy	Temperature Coefficient/°C	
	30.00000 mA	0.00001 mA	0.1 + 0.05	0.001	
	300.0000 mA	0.0001 mA	0.1 + 0.05	0.001	
	3.000000 A	0.000001 A	0.1 + 0.05	0.001	
	30.00000 A ^{*1}	0.00001 A	0.1 + 0.05	0.001	
300.0000 A ^{*1}	0.0001 A	0.2 + 0.05	0.001		
Accuracy specification : ±(% of output + % of full scale);monitor output voltage for the full scale current = 3V					
AC CHARACTERISTICS	True RMS AC Voltage	Range	Frequency	1 Year 23 °C ± 5 °C	Temperature Coefficient/°C
		200.0000 mV	45Hz~2kHz	0.5 + 0.05	0.005 + 0.005
		2.000000 V			0.005 + 0.005
		20.00000 V	2kHz~10kHz	1.0 + 0.05	0.005 + 0.005
		200.0000 V	10kHz~20kHz	2.0 + 0.10	0.005 + 0.005
		600.000 V			0.005 + 0.005
	Accuracy specification : ±(% of reading + % of range)				
	True RMS AC Current	Range	Frequency	1 Year 23 °C ± 5 °C	Temperature Coefficient/°C
		30.00000 mA	45Hz~2kHz	0.5 + 0.05	0.03 + 0.006
		300.0000 mA			0.03 + 0.006
		3.000000 A	2kHz~10kHz	1.0 + 0.05	0.03 + 0.006
		30.00000 A ^{*1}	45Hz~400Hz	0.5 + 0.05	0.03 + 0.006
		300.0000 A ^{*1}			0.03 + 0.006
	Accuracy specification : ±(% of reading + % of range)				
	Isolated AC Current Monitor Accuracy	Range	Frequency	AC Accuracy	Temperature Coefficient/°C
		30.00000 mA	45Hz~2kHz	0.2 + 0.05	0.001
		300.0000 mA			0.001
		3.000000 A	2kHz~10kHz	0.5 + 0.05	0.001
30.00000 A ^{*1}		45Hz~400Hz	0.5 + 0.05	0.001	
300.0000 A ^{*1}				0.001	
Accuracy specification : ±(% of output + % of full scale); monitor output voltage for the full scale current = 3V; The specifications are only applicable when the input is 10% or greater of the full scale range					
GENERAL	Power Supply	100 V/120 V/220 V/240 V ±10%			
	Power Line Frequency	50/60 Hz			
	Operating Environment	Full accuracy for 0 °C ~ 55 °C, Full accuracy to 80% R.H. at 40 °C			
	Storage Environment	-40 °C ~ 70 °C			
Power Consumption	Max 35VA				
Dimensions Weight	210(W) x 80(H) x 390(D)mm ; Approx. 5 kg				

(The specifications apply when the PCS-1000I is powered on for at least 30 minutes to warm-up to a temperature of 18 °C ~ 28 °C, unless specified otherwise.)

Note: *1 The accuracy for 30A/300A levels must be increased by a power factor of 8 ppm/watt.

Specifications subject to change without notice. CS1000IGD1BH

ORDERING INFORMATION

PCS-1000I Isolated Output High Precision Current Shunt Meter

ACCESSORIES

Quick Operation Guide, User Manual (CD) x 1, AC Power Cord x 1 (Region Dependant),

GTL-105A Alligator Clip Test Lead (3A Max) **GTL-240** USB Cable

GTL-207 Banana Plug Test Lead **PCS-001** Basic Accessory Kit

OPTIONAL ASSESSORIES

GRA-419-J Rack Mount Adapter (JIS)

GRA-419-E Rack Mount Adapter (EIA)

Global Headquarters
GOOD WILL INSTRUMENT CO., LTD.
T +886-2-2268-0389 F +886-2-2268-0639

China Subsidiary
GOOD WILL INSTRUMENT (SUZHOU) CO., LTD.
T +86-512-6661-7177 F +86-512-6661-7277

Malaysia Subsidiary
GOOD WILL INSTRUMENT (M) SDN. BHD.
T +604-6111122 F +604-6115225

Europe Subsidiary
GOOD WILL INSTRUMENT EURO B.V.
T +31(0)40-2557790 F +31(0)40-2541194

U.S.A. Subsidiary
INSTEK AMERICA CORP.
T +1-909-399-3535 F +1-909-399-0819

Japan Subsidiary
TEXIO TECHNOLOGY CORPORATION.
T +81-45-620-2305 F +81-45-534-7181

Korea Subsidiary
GOOD WILL INSTRUMENT KOREA CO., LTD.
T +82-2-3439-2205 F +82-2-3439-2207

GW INSTEK
Simply Reliable



www.gwinstek.com

www.facebook.com/GWInstek