

# Digital Storage Oscilloscope

GDS-2000HD/HG Series

---

**USER MANUAL**



ISO-9001 CERTIFIED MANUFACTURER

**GW INSTEK**

This manual contains proprietary information, which is protected by copyright. All rights are reserved. No part of this manual may be photocopied, reproduced or translated to another language without prior written consent of Good Will company.

The information in this manual was correct at the time of printing. However, Good Will continues to improve products and reserves the rights to change specification, equipment, and maintenance procedures at any time without notice.

**Good Will Instrument Co., Ltd.**  
**No. 7-1, Jhongsing Rd., Tucheng Dist., New Taipei City 236, Taiwan.**

# Table of Contents

<b>SAFETY INSTRUCTIONS</b> .....	<b>5</b>
<b>GETTING STARTED</b> .....	<b>9</b>
Front Panel .....	10
Rear Panel .....	14
User Interface Introduction .....	16
Oscilloscope Inspection .....	18
<b>USE THE ANDROID SYSTEM</b> .....	<b>22</b>
Android System Homepage Window .....	23
System Built-in Application List .....	24
<b>BASIC OPERATION</b> .....	<b>25</b>
Trigger system .....	26
AFG system (GDS-2254HG, GDS-2354HG, GDS-2504HG) .....	27
Horizontal system .....	28
Vertical system .....	29
How to use touch screen control .....	31
<b>ADVANCED OPERATION</b> .....	<b>38</b>
How to set vertical system .....	42
How to set horizontal system .....	49
How to set acquire .....	52
How to set trigger .....	56
Introduction to Built-in Analysis Modules .....	88
How to set automatic measurement .....	89
How to set XY mode .....	99
How to set cursor measurement .....	100

How to realize waveform operation function .....	107
How to set FFT .....	111
How to set magnifier .....	116
How to set Filters (Digital Filtering) .....	118
How to set FRA (Frequency Response Analysis) (for GDS-2000HG Series only) .....	120
How to set pass fail .....	123
How to set counter .....	126
How to set DVM .....	128
How to set decode .....	131
How to set display system .....	147
How to save .....	151
How to set reference waveform .....	154
How to set waveform clone (for GDS-2000HG Series only) .....	156
How to conduct probe check .....	159
How to set network.....	160
How to use execution keys.....	164
<b>ARBITRARY WAVEFORM GENERATOR .....</b>	<b>167</b>
Display window.....	168
Setting .....	169
Connect the output end .....	169
Set the channel .....	170
Set the waveform .....	171
Output Built-in Waveform .....	175
Output Modulation Waveform .....	177
Output Sweep Waveform .....	179
Generate Burst.....	181
<b>SPECIFICATIONS.....</b>	<b>182</b>
Certificate Of Compliance .....	189

# S SAFETY INSTRUCTIONS

This chapter contains important safety instructions that you must follow during operation and storage. Read the following before any operation to insure your safety and to keep the instrument in the best possible condition.

## Safety Symbols

These safety symbols may appear in this manual or on the Product name.

---



WARNING

Warning: Identifies conditions or practices that could result in injury or loss of life.



CAUTION

Caution: Identifies conditions or practices that could result in damage to the equipment or to other properties.



DANGER High Voltage



(Note)

Attention required. Refer to the Manual



Protective Conductor Terminal



Earth (ground) Terminal



Do not dispose electronic equipment as unsorted municipal waste. Please use a separate collection facility or contact the supplier from which this instrument was purchased.

## Safety Guidelines

---

General Guideline • Make sure the BNC input voltage does not exceed 300 Vrms.



WARNING



CAUTION

- Never connect a hazardous live voltage to the ground side of the BNC connectors. It might lead to fire and electric shock.
- Do not place any heavy object on the GDS-2000HD/HG series.
- Avoid severe impact or rough handling that leads to damaging the GDS-2000HD/HG series.
- Do not discharge static electricity to the GDS-2000HD/HG series.
- Use only mating connectors, not bare wires, for the terminals.
- Do not block the cooling fan opening.
- Do not perform measurement at a power source or building installation (Note below).
- Do not disassemble the GDS-2000HD/HG series unless you are qualified.



Note

(Measurement categories) EN 61010-1:2010 specifies the measurement categories and their requirements as follows. The GDS-2000HD/HG series falls under category I.

- Measurement category IV is for measurements performed at the source of low-voltage installation.
  - Measurement category III is for measurements performed in the building installation.
  - Measurement category II is for measurements performed on circuits directly connected to the low voltage installation.
  - Measurement category I is for measurement performed on circuits not directly connected to Mains.
-

## Power Supply

**WARNING**

- AC Input voltage: 100 VAC to 240 VAC, 50 Hz to 60 Hz, auto selection. Power consumption: GDS-2000HD series < 35W, GDS-2000HG series < 50W.
  - Connect the protective grounding conductor of the AC power cord to an earth ground, to avoid electrical shock.
- 

Cleaning the  
GDS-2000HD/  
HG series

- Disconnect the power cord before cleaning.
  - Use a soft cloth dampened in a solution of mild detergent and water. Do not spray any liquid.
  - Do not use chemicals containing harsh materials such as benzene, toluene, xylene and acetone.
- 

Operation  
Environment

- Location: Indoor, no direct sunlight, dust free, almost non-conductive pollution (Note below)
- Relative Humidity:  $\leq 90\%$  (non-condensing)
- Altitude: < 2000 m
- Temperature: 0 °C to 40 °C

**Note**

(Pollution Degree) EN 61010-1:2010 specifies the pollution degrees and their requirements as follows. The GDS-2000HD/HG series falls under degree 2.

Pollution refers to “addition of foreign matter, solid, liquid, or gaseous (ionized gases), that may produce a reduction of dielectric strength or surface resistivity”.

- Pollution degree 1: No pollution or only dry, non-conductive pollution occurs. The pollution has no influence.
  - Pollution degree 2: Normally only non-conductive pollution occurs. Occasionally, however, a temporary conductivity caused by condensation must be expected.
  - Pollution degree 3: Conductive pollution occurs, or dry, non-conductive pollution occurs which becomes conductive due to condensation which is expected. In such conditions, equipment is normally protected against exposure to direct sunlight, precipitation, and full wind pressure, but neither temperature nor humidity is controlled.
-

**Storage environment**

- Location: Indoor
  - Temperature: -20 °C to 60 °C
  - Humidity: Up to 80% RH (non-condensing)
- 

**Disposal**

Do not dispose this instrument as unsorted municipal waste. Please use a separate collection facility or contact the supplier from which this instrument was purchased. Please make sure discarded electrical waste is properly recycled to reduce environmental impact.

# G ETTING STARTED

This chapter makes a simple description of the operation and function of the front panel of the oscilloscope, enabling you to be familiar with the use of the oscilloscope in the shortest time.

---

Front Panel.....	10
GDS-2254HG, GDS-2354HG, GDS-2504HG .....	10
GDS-2254HD, GDS-2354HD, GDS-2504HD.....	11
Rear Panel .....	14
User Interface Introduction.....	16
Oscilloscope Inspection.....	18
How to Implement the Probe Compensation .....	18
To set the Probe Attenuation Coefficient.....	20
How to Use the Probe Safely .....	21
How to Implement Self-calibration .....	21

## Front Panel

The front panel has knobs and function buttons. The 5 buttons in the column on the right side of the display screen are menu selection buttons, through which, you can set the different options for the current menu. The other buttons are function buttons, through which, you can enter different function menus or obtain a specific function application directly.

GDS-2254HG, GDS-2354HG, GDS-2504HG

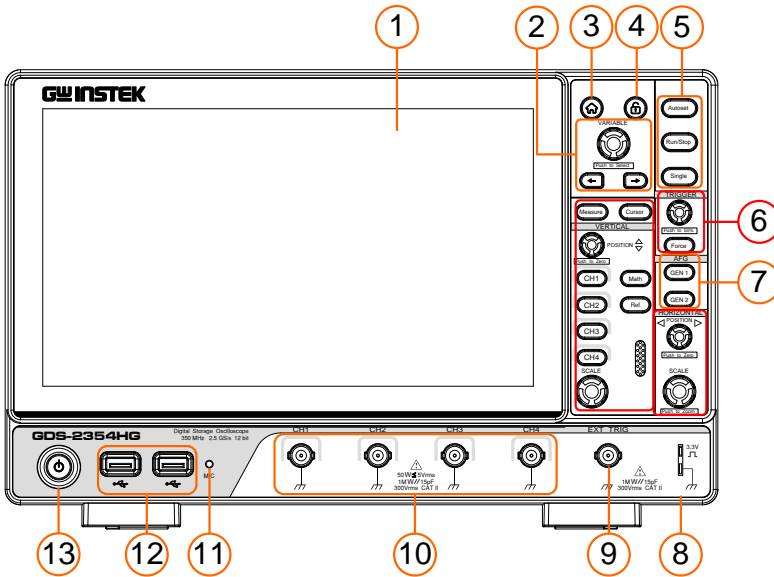



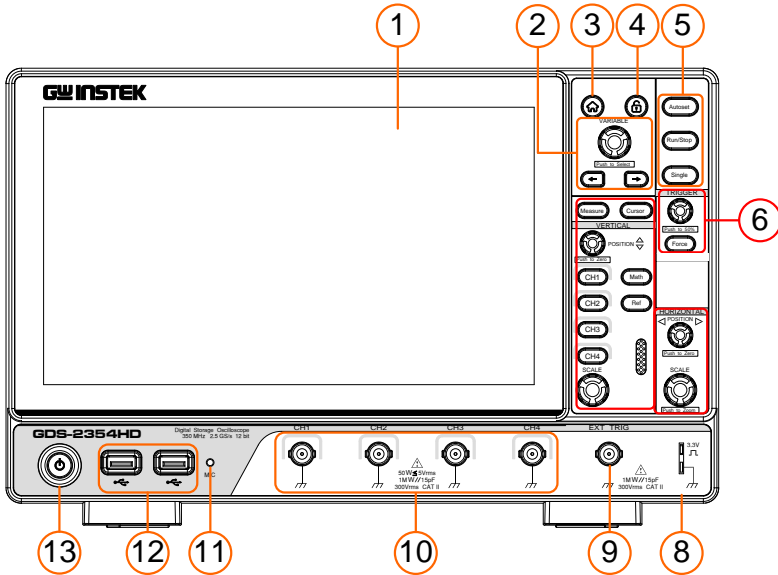

GDS-2254HD, GDS-2354HD, GDS-2504HD



1. Display area                      The display area supports touch operation

 **Note**                      10 seconds idle user configuration auto save.

2. General knob and arrow keys                      • General knob: When  appears in the screen menu, it can be turned to set the value. Example  can rotate the knob to change the offset value.

• Arrow keys  : Move to select the parameter.

3. Home key                       Return to the main homepage.

4. Touch key                       Press it to disable the touch screen, the key light turns on; and press it again to enable the touch screen, the key light turns off.



Note

The touch lock is only available in the instrument system and does not function on the main screen or other application interfaces.

- 
- |    |                         |   |
|----|-------------------------|---|
| 5. | Shortcut key            | Run/Stop, Autoset, Single.  |
| 6. | Function control area   | <p>It contains two keys.</p> <ul style="list-style-type: none"> <li>● “Measure” key corresponds to enable/disable the measurement function.</li> <li>● “Cursor” key corresponds to enable/disable the cursor function.</li> </ul>   |
|    | Trigger control area    | <p>It contains one key and one knob.</p> <ul style="list-style-type: none"> <li>● “Trigger Level” knob is to adjust trigger level.</li> <li>● Force key is the forced trigger shortcut key.</li> </ul>  |
|    | Vertical control area   | <p>It contains six keys and two knobs.</p> <ul style="list-style-type: none"> <li>● “CH1”, “CH2”, “CH3” and “CH4” keys are correspond to the channel switch of Channel 1, Channel 2, Channel 3 and Channel 4 respectively.</li> <li>● “Math” key corresponds to enable/disable the waveform math function.</li> <li>● “Ref” key corresponds to enable/disable the reference waveform function.</li> <li>● “Vertical Position” knob is to control the vertical position of selected channel.</li> <li>● “Vertical Scale” knob is to control the voltage scale for selected channel.</li> </ul> |
|    | Horizontal control area | <p>It contains two knobs.</p> <ul style="list-style-type: none"> <li>● “Horizontal Position” knob is to control the horizontal position</li> </ul>  |

- 
- triggered.
- “Horizontal Scale” knob is to control time base scale.
7. AFG control area (only for GDS-2000HG series) It contains two keys.
- “GEN 1 ON/OFF” key corresponds to enable/disable the AFG function.
  - “GEN 2 ON/OFF” key corresponds to enable/disable the AFG function.
8. Probe compensation About 3.3 V/1 kHz signal output.
9. External trigger interface
10. Channel input port area
11. Microphone port
12. USB host interface When the oscilloscope is connected to an external USB device as a “master device”, the USB Host interface is used to transmit the data.



Note

The devices that can be connected include a mouse, keyboard, USB flash drive, etc.

---

13. Power switch Instrument switch with memory (self-lock) switch and auto memory of last shutdown; if the instrument is shut down by powering the supply off, there is no need to press the switch to start it up after next power-on; if the instrument is shut down by pressing the switch key, it is required to press the switch key again to power it on.

## Rear Panel

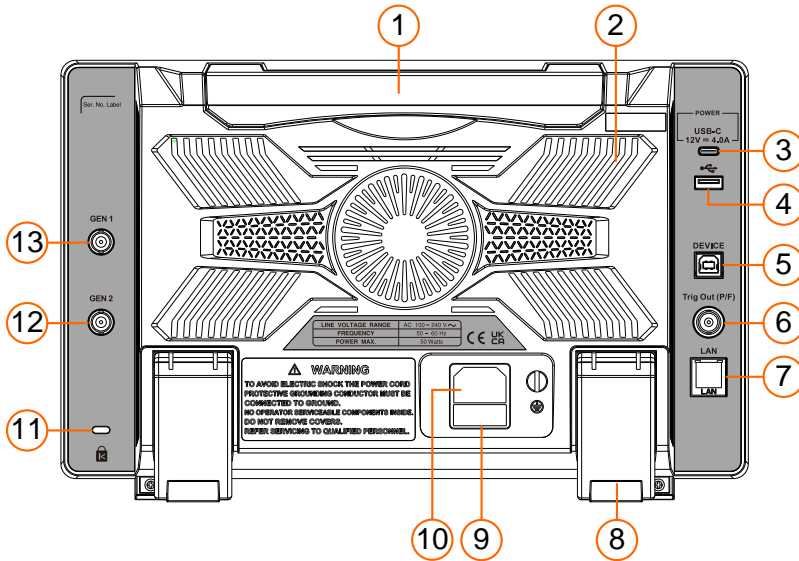



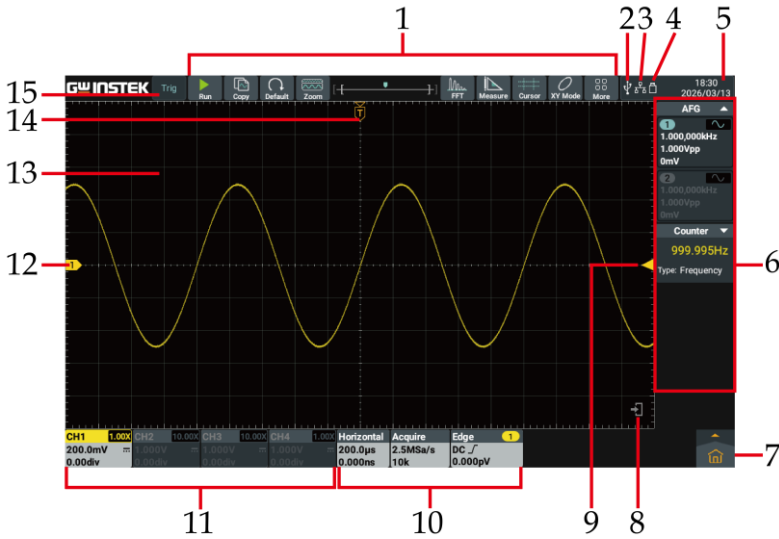

1. Foldable handle
2. Heat emission hole
3. USB-C power supply interface
4. USB host interface  
When the oscilloscope is connected to an external USB device as a “master device”, the USB Host interface is used to transmit the data.
5. USB device interface  
When the oscilloscope is connected to an external USB device as a “slave device”, the USB Device interface is used to transmit the data. For example, use the interface to connect a PC.
6. Trig out (P/F) interface  
Trigger output or pass/fail output port.

7. LAN interface      The network interface to connect a PC or router.
8. Foot rest            To adjust the inclined angle of the oscilloscope.
9. Fuse
10. Power outlet
11. Safety lock
12. AFG GEN 2 port    Only available on HG models (GDS-2254HG, GDS-2354HG, GDS-2504HG)
13. AFG GEN 1 port

## User Interface Introduction



1. Shortcut soft keys of oscilloscope functions
2. USB Device access identifier
3. LAN port access identifier
4. U disk access identifier.
5. System set time, click the icon will switch to the Date&time setting interface.
6. AFG, Counter and others functions information display bar (Note: click  /  on the left corner corresponds to enable/disable statistic). Right swipe the information display bar to close the corresponding function.
7. Main menu key, click to show/hide the main menu.
8. Hide/show the information display bar on the right.
9. Trigger level position, press and hold can be center.

10. Function information display bar: display Horizontal, Acquire, Trigger information respectively. Click the bar can show/hide the corresponding setting window.
11. Channel information display bar. Display the configure information of Channel 1, Channel 2, Channel 3 and Channel 4 respectively  
(Note: The swipe down the bar can turn on or off the waveform display).  
Among:  
BW indicates that the bandwidth limit is 20 MHz.  
“” indicates DC coupling  
“” indicates AC coupling  
“” indicates Ground coupling.
12. Channel waveform.
13. Waveform display area.
14. Time base position, press and hold can be center.
15. Display the current running status.

## Oscilloscope Inspection

Make a fast function check to verify the normal operation of the instrument, according to the following steps:

- Steps
1. Set the Switch in the Oscilloscope Probe as 10 X and Connect the Oscilloscope with CH1.
  2. Align the slot in the probe with the plug in the CH1 connector BNC, and then tighten the probe with rotating it to the right side.
  3. Connect the probe tip and the ground clamp to the connector of the probe compensator.

Connect the probe tip and the ground clamp to the connector of the probe compensator.

4. Perform Autoset.

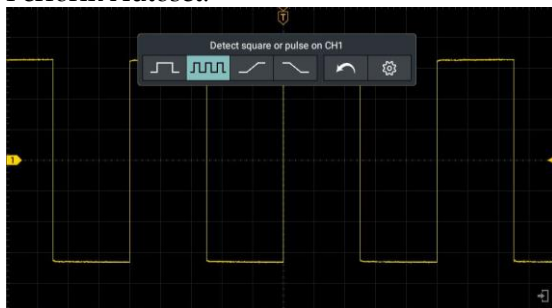

The square wave of 1 kHz frequency and about 3.3 V peak-peak value will be displayed in several seconds (see the figure above). Check CH2, CH3 and CH4 by repeating Step 2 and Step 3.

### How to Implement the Probe Compensation

When connect the probe with any input channel for the first time, make this adjustment to match the probe with the input channel. The probe which is not compensated or presents a compensation deviation will result in the measuring error or mistake. For

adjusting the probe compensation, please carry out the following steps:

- Steps
1. Set the attenuation coefficient of the probe in the menu as 10 X and that of the switch in the probe as 10 X (see “To set the Probe Attenuation Coefficient” on page 20), and connect the probe with the CH1 channel. If a probe hook tip is used, ensure that it keeps in close touch with the probe. Connect the probe tip with the signal connector of the probe compensator and connect the reference wire clamp with the ground wire connector of the probe connector, and then push the Autoselect button on the front panel.
  2. Check the displayed waveforms and regulate the probe till a correct compensation is achieved (see figures below)

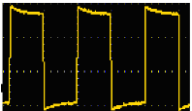
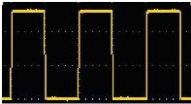
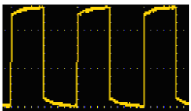
Displayed Waveforms of the Probe Compensation		Overcompensated
		Compensated correctly
		Under compensated

Adjust Probe

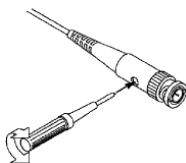

3. Repeat the steps mentioned if needed.

## To set the Probe Attenuation Coefficient

The probe has several attenuation coefficients, which will influence the vertical scale factor of the oscilloscope.

To change or check the probe attenuation coefficient in the menu of oscilloscope:

- 
- |       |   |
|-------|---|
| Steps | <ol style="list-style-type: none"><li>1. Click the channel information display bar on the bottom left of the screen (CH1 Channel, CH2 Channel, CH3 Channel or CH4 Channel).</li><li>2. Select Probe Attenu (1 X, 10 X or other custom probe magnifications) in the displayed channel setting window. The setting will remain in effect until changed again after selection.</li></ol> |
|-------|---|
- 



Caution

The default attenuation coefficient of the probe on the instrument is preset to 10 X.

Make sure that the set value of the attenuation switch in the probe is the same as the menu selection of the probe attenuation coefficient in the oscilloscope.

The set values of the probe switch are 1 X and 10 X (See the figure below)

Attenuation  
Switch

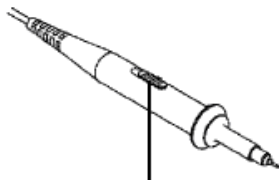

Caution

When the attenuation switch is set to 1 X, the probe will limit the bandwidth of the oscilloscope in 5 MHz. To use the full bandwidth of the oscilloscope, the switch must be set to 10 X.

## How to Use the Probe Safely

The safety guard ring around the probe body protects your finger against any electric shock, shown as figure below.

Finger Guard

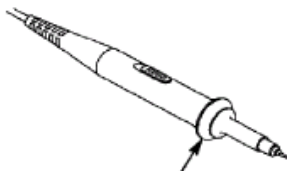

Warning

To avoid electric shock, always keep your finger behind the safety guard ring of the probe during the operation.

To protect you from suffering from the electric shock, do not touch any metal part of the probe tip when it is connected to the power supply.

Before making any measurements, always connect the probe to the instrument and connect the ground terminal to the earth.

## How to Implement Self-calibration

Self-calibration program is used to quickly make the oscilloscope be in the optimum condition to obtain the most accurate measurement. This program can be performed at any time. It is especially necessary when the ambient temperature reaches or exceeds 5 °C.

To conduct self-calibration, disconnect all probes and wires from the input connector. Then, click “” in the lower right of the screen, select Self-Calibration from the menu displayed and click Start in the self-calibration display box.

# U**SE THE ANDROID** **SYSTEM**

---

Android System Homepage Window.....	23
System Built-in Application List.....	24

## Android System Homepage Window

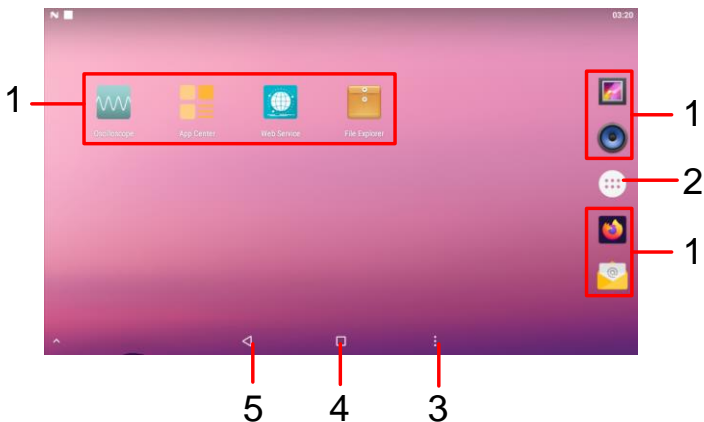

- 
1. Application shortcut key. If you click the oscilloscope shortcut key, you can enter the oscilloscope interface. 
  2. App Drawer (Click to see all apps).
  3. Task key
  4. Home key
  5. Back key

## System Built-in Application List

Open the application drawer of the main page. The system built-in application including: App Center, Calculator, Calendar, Clock, Email, File Explorer, Firefox, Gallery, Music, Oscilloscope, Screen Recorder, Settings, Sound Recorder, Web Service, WPS Office, Google Pinyin input, as shown in the following figure.



# BASIC OPERATION

---

Trigger system.....	26
AFG system (GDS-2254HG, GDS-2354HG, GDS-2504HG) .....	27
Horizontal system.....	28
Vertical system.....	29
How to use touch screen control .....	31
Use the touch screen to operate the menu .....	31
Operate the touch screen .....	32
Operate the touch screen in waveform amplification mode .....	34
Other touch screen operations .....	36

## Trigger system

As shown in Figure 5-1, there are one knob and one key. The following exercises are to guide you through the use of the trigger system.

Figure 5-1

Trigger control area

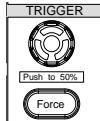

Caution

Turning the Trigger Level knob can not only change the trigger level value, but also set the shortcut key of the trigger level at the vertical midpoint of the trigger signal amplitude.

1. Use Trigger Level knob to change the settings of the trigger level.  
Rotary the Trigger Level knob, the trigger pointer on the screen moves up and down as the knob turns. While moving the trigger pointer, the value of the trigger level on the screen changes accordingly.
2. Press Force key to generate a trigger signal forcibly, mainly used in the "Normal" and "Single" trigger mode.

## AFG system (GDS-2254HG, GDS-2354HG, GDS-2504HG)

As shown in Figure 5-2, there is two keys. The following exercises are to guide you through the use of the AFG system.

---

Figure 5-2

AFG control area

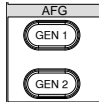

1. Press GEN 1 ON/OFF key to enable/disable the GEN 1 AFG function. Open the key light on, close the key light off.
  2. Press GEN 2 ON/OFF key to enable/disable the GEN 2 AFG function. Open the key light on, close the key light off.
-

## Horizontal system

As shown in Figure 5-3, there are two knobs. The following exercises to guide you through the use of the horizontal system.

---

Figure 5-3  
Horizontal  
control area

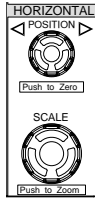

1. Rotary Horizontal Position knob to adjust the horizontal position of the signal in the waveform window.  
The Horizontal Position knob is to control the triggered horizontal position of the signal; when turning the knob, the waveform moves horizontally with the knob. When pressing the Horizontal Position key, the horizontal displacement can be zero.
  2. Rotary the Horizontal Scale knob to change the settings of the horizontal time base and thus observe the resulting change of the status information, then the corresponding Horizontal Time Base in the status bar changes accordingly. Press the Horizontal Scale knob enter or exit waveform zoom mode.
-

## Vertical system

As shown in Figure 5-4, there are six keys and two knobs. The following exercises are to guide you through the use of the vertical system.

Figure 5-4

Vertical control area

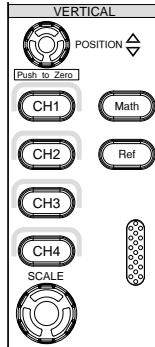

1. Vertical Position knob to control the vertical display position of the signal. When turning the Vertical Position knob, the pointer indicating the Grounding Reference Point of the channel moves up and down following the waveform. When pressing the Vertical Vertical key, the vertical position can be zero.

### Measuring Skills

- If the DC coupling mode is adopted for the channel, observe the gap between the waveform and the signal ground to quickly measure the DC component of the signal.
- If the AC coupling mode is adopted for the channel, the DC component of the signal is filtered out, facilitating you to display the AC component of the signal with higher sensitivity.
- If the Ground coupling mode is adopted for the channel, indicates that the internal input is grounded and the external input is

disconnected. It can effectively reduce the influence of external interference on the measurement results and ensure the accuracy of the measurement.

2. Change the vertical settings and observe the resulting status change.  
You can determine the change of the vertical scale factor of any channel through the information displayed in the information display bar at the lower part of the waveform window.
    - Turn the Vertical Scale knob to change the Vertical Scale Factor (Voltage Scale), and the scale factor of corresponding channel in the information display bar changes accordingly.
  3. Press CH1、CH2、CH3、CH4 key to enable or disable the corresponding channel.
    - If the current channel is disable, press it to enable and select the channel.
    - If the current channel is enable but no selected, press it to select the channel.
    - If the current channel is enable and selected, press it to disable the channel.
  4. Press Math key to enable/disable waveform math function; press Ref key to enable/disable reference waveform function.
-

## How to use touch screen control

The touch screen can be used to control the oscilloscope by various gestures.

Operate the touch screen when the light of the touch lock in the upper right of the front panel is off; click the key to light up the indicator; the touch function is disabled when the touch lock is in locked state.

The instructions of the touch screen operations are as follows, the contents in the parentheses indicate the key or knob that plays the same role.

### Use the touch screen to operate the menu

**Open the Settings window function** Directly click the below or right information display bar to pop up the corresponding function of the setting window.

**Set Menu Item** In the Settings window, you can change the configuration of the relevant menu item by touching it. The types of operable parts include: switch, button, multiple choice, gear hobbing (scrolling list), etc. The following box selects the multiple choice, click directly to switch the options.

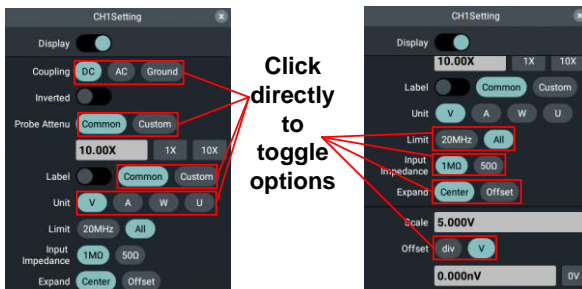

**Scroll List** When the scroll bar appears in the menu, swipe the screen up and down with the finger to scroll the list, as shown in the figure below.

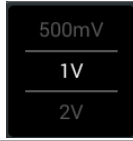

Open Main Menu

Click the  icon in the lower right of the display area, the main menu window pops up, as shown below. Click each item in the main menu window to open the settings window of the corresponding function, and click the shortcut key at the top of the screen to open the corresponding function.

Click the shortcut key to open the corresponding function directly



Click on the items in the main menu window to open the corresponding settings window

## Operate the touch screen

Select a Channel (CH1 channel, CH2 channel, CH3 channel or CH4 channel)

Click the channel pointer on the left or click the channel waveform to make the channel pointer selected. Long press the channel pointer, the vertical position of waveform can be center.

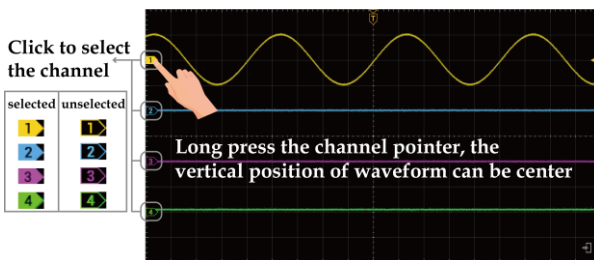

Set the vertical position of the selected channel waveform (Vertical Position knob)

The vertical position of the waveform can be changed by swiping your finger up and down in the blank position of the waveform display area, as shown in the figure below.

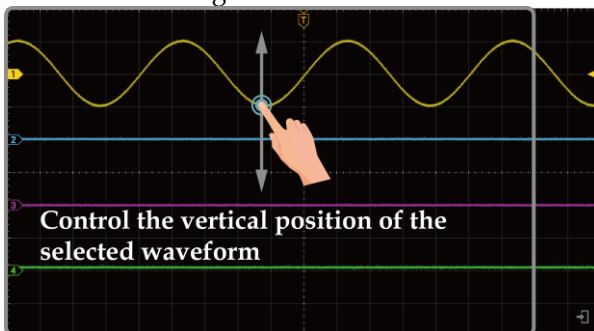

Set the trigger level of the signal source in the trigger menu (Trigger Level knob)

The two grids on the right of the waveform area are the trigger level touch moving area, and the trigger level can be changed by sliding up and down in this area, as shown in the figure below.

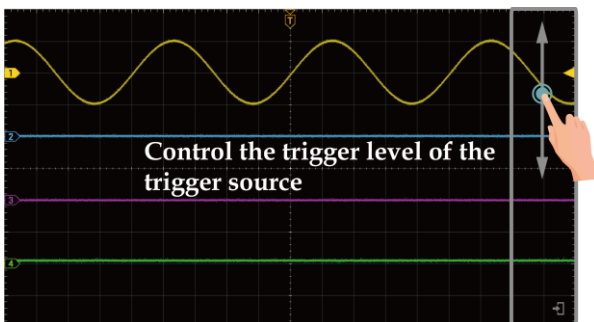

Set Horizontal Position

The horizontal position of the waveform can be changed by swiping your finger around the

(Horizontal  
Position knob)

waveform display area, as shown in the figure below.

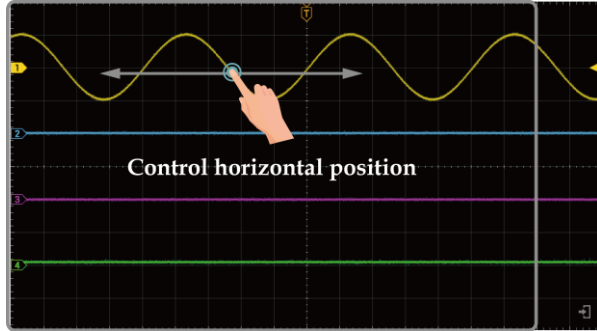

The control voltage gear and time base can be scaled in the following way

- In the waveform display area, up and down/left and right zoom thumb and index finger to zoom control voltage scale and time base, as shown in the figure below.

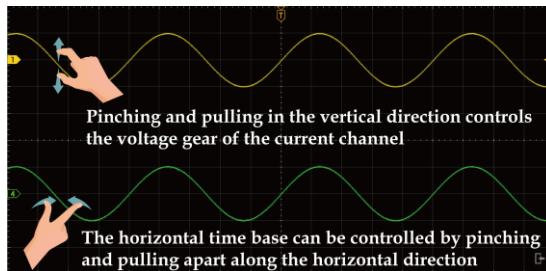

- In the waveform display area, double-click the screen and slide the hand up and down/left and right to zoom the control voltage scale and time base.

## Operate the touch screen in waveform amplification mode

Press Horizontal Scale knob to enter the waveform zoom mode, the main window is displayed at the top half of the screen and the amplified window is displayed at the bottom half of the screen. The

amplified window is the amplified part of the main window that is selected.

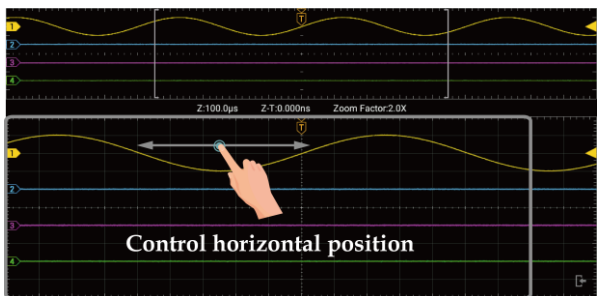
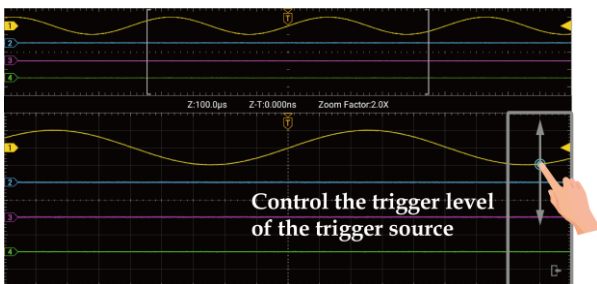
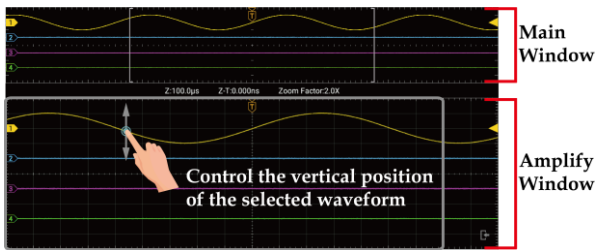

## Other touch screen operations

- Click and drag the open menu item to move itself to the appropriate location.



- Control the horizontal or vertical cursor lines under cursor measurement, as shown in the figure below.

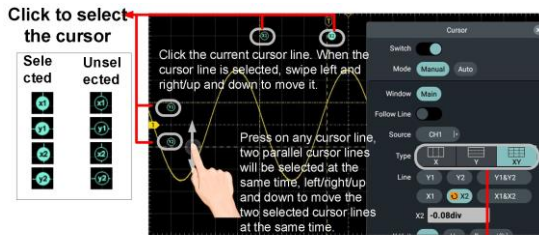

**Toggle horizontal/vertical/horizontal & vertical cursor lines.**

- Run/Stop  
Click or in the upper left of the display area to switch Run/Stop.
- Parameter Setting Keyboard in Menu Item  
There are digital input mode and hobbing input mode.  
Digital input mode, as shown in the figure below.

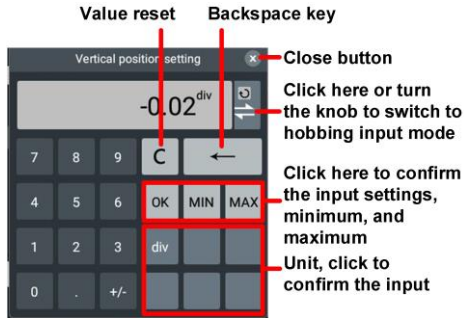

Hobbing input mode, as shown in the figure below.

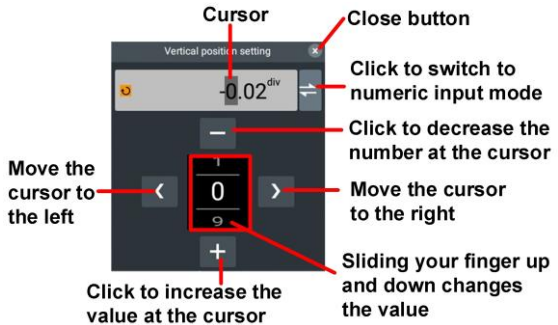

- Swipe the information display bar

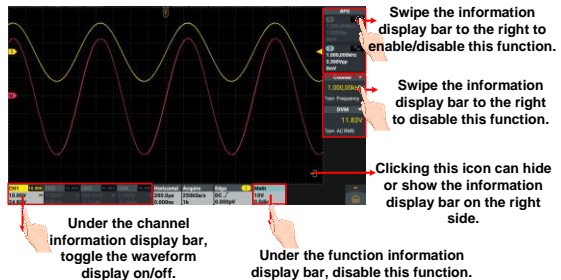

# A DVANCED OPERATION

In the previous chapter, basic operations of the oscilloscope, function area of the front panel and the roles of the keys and knobs are introduced for the user to determine the change of instrument settings by observing the status bar. For any details of the operations and methods mentioned above, refer to chapter “BASIC OPERATION” on page 25.

---

How to set vertical system .....	42
Channel Settings .....	42
Application of Math key and Ref key .....	48
Application of Vertical Position knob and Vertical Scale knob .....	48
How to set horizontal system .....	49
How to set acquire .....	52
Segmented Acquisition Instructions .....	54
How to set trigger .....	56
Trigger Control .....	56
Introduction to Built-in Analysis Modules .....	88
How to set automatic measurement .....	89
Add/Delete .....	90
Automatic Measurement of Horizontal Parameters .....	91
Automatic Measurement of Vertical Parameters .....	92
Blend Measurement .....	93
Automatic Measurement of Inter-channel Parameters .....	94
Statistics .....	96

Indicator.....	97
Setting.....	97
How to set XY mode .....	99
How to set cursor measurement .....	100
Cursor Measurement in General Mode .....	100
Use Gestures To Move The Cursor Line .....	103
Cursor Measurement in Zoom Mode.....	103
Cursor Measurement in FFT Mode .....	104
Cursor Measurement in XY Mode .....	105
How to realize waveform operation function .....	107
Waveform Calculation.....	108
Custom Function Operation.....	109
How to set FFT .....	111
The Description of FFT Window .....	113
How to set magnifier .....	116
How to set Filters (Digital Filtering) .....	118
How to set FRA (Frequency Response Analysis) (for GDS-2000HG Series only) .....	120
How to set pass fail .....	123
Pass/Fail .....	124
How to set counter .....	126
How to set DVM .....	128
How to set decode .....	131
RS232/UART Decode.....	132
I <sup>2</sup> C Decode .....	134
SPI Decode.....	137
CAN Decode.....	140
LIN Decode .....	142
How to set waveform record/player.....	144
How to set display system .....	147
How to save .....	151
USB Flash Drive Requirements.....	153

How to set reference waveform .....	154
How to set waveform clone (for GDS-2000HG Series only) .....	156
Save Cloned Waveform.....	158
Output Cloned Waveform .....	158
How to conduct probe check .....	159
How to set network.....	160
Default.....	160
About.....	160
Configuration .....	160
Hardware-Test.....	163
How to use execution keys.....	164

Please carefully read this chapter to understand various measuring functions and other operation methods of the oscilloscope.

- How to set vertical system → from page 42
- How to set horizontal system → from page 49
- How to set acquire → from page 52
- How to set trigger → from page 56
- How to set automatic measurement → page 89
- How to set XY mode → from page 99
- How to set cursor measurement → from page 100
- How to realize waveform operation function → from page 107
- How to set FFT → page 111
- How to set magnifier → from page 116
- How to set Filters (Digital Filtering) → from page 118
- How to set FRA (Frequency Response Analysis)  
(for GDS-2000HG Series only) → from page 120
- How to set pass fail → page 123
- How to set counter → from page 126
- How to set DVM → from page 128
- How to set decode → from page 131
- How to set display system → page 147
- How to set save → from page 151
- How to set reference waveform → from page 154
- How to set waveform clone (for GDS-2000HG Series only)  
→ from page 156
- How to conduct probe check → page 159
- How to set network → page 160
- How to use execution keys → from page 164

## How to set vertical system

In the vertical system control area, there are seven keys (CH1, CH2, CH3, CH4, Math and Ref) and two knobs (Vertical Position knob and Vertical Scale knob).

### Channel Settings

Each channel is equipped with the independent vertical menu, and each item is set separately based on different channel.

---

- How to enable or disable the waveform (channel)
1. Press CH1, CH2, CH3, CH4 key produces the following results:
    - If the channel disable, press it enable the channel.
    - If the channel enable but no selected, press it select the channel.
    - If the channel enable and selected, press it disable the channel.
  2. Swipe down CH1, CH2, CH3, CH4 information display bar produces the following results:
    - If the channel disable, swipe down it enable the channel.
    - If the channel enable, swipe down it disable the channel.
  3. Click CH1, CH2, CH3, CH4 information display bar produces the following results:
    - If the channel disable, click it enable and selected the channel.
    - If the channel enable but no selected, click it selected the channel.
    - If the channel enable and selected, click it open/close the channel setting.

How to open the channel settings window. Click the information display bar on the left corner of the screen, it will pop up the setting window.

Channel setting window is described in the table below:

Function Menu	Setting	Description
Display		Click to open/ close the channel waveform.
Coupling	DC	Pass both AC and DC components of the input signal.
	AC	Block the DC component of the input signal.
	Ground	Disconnect the input signal.
Inverted		Click to open or close the waveform inversion function.
Probe Attenuation	Common	Click the Numeric Display Box and turn General knob or swipe the screen up and down in the numeric select box with the finger to select commonly used magnification; it is also available to set 1 X and 10 X probe magnification with 1 X and 10 X keys.
	Custom	Click the Numeric Display Box to set the probe magnification within the range between 1 uX and 1 MX.
Label		Click the switch to the right of the Label item to choose to display or not display the channel label.
	Common	Set a common display label for a channel. Click the label box, adjust the universal knob or swipe up and down in the label selection box with your finger to select some commonly used labels.
	Custom	Click on the channel label input box and enter the string directly through the letter keyboard that pops up.

Unit	V A W U	Set the display unit of current channel as required.
Limit	20 MHz	Limit to 20 MHz to reduce the display noise.
	All	The bandwidth of the oscilloscope.
Input Impedance	1 MΩ 50 Ω	Select 1 MΩ or 50 Ω as the input impedance.
Expand	Center	Based on the vertical center point of the screen, the waveform will be scaled around the vertical center point of the oscilloscope screen.
	Offset	Based on the vertical zero point of the channel, the waveform will be scaled around the channel's zero level.
Scale	500.0 uV	Select the optimum gear as required.  Note: Current unit selection is V and the voltage gear of the probe multiplier is 1 X.
	1.000 mV	
	2.000 mV	
	5.000 mV	
	10.00 mV	
	20.00 mV	
	50.00 mV	
	100.0 mV	
	200.0 mV	
	500.0 mV	
	1.000 V	
	2.000 V	
	5.000 V	
10.00 V		
Offset	div,	According to requirement to set offset unit. Set the vertical display position of the waveform; due to limited screen display, the visible range is ±5 div.
	Current Unit	
	Vertical position settings	

---

**Channel 1** is taken as an example to set the channel, and the operation steps are as follows:

Set channel coupling	<p>The measured signal is a square-wave signal with DC bias.</p> <ol style="list-style-type: none"><li>1. Click the CH1 information display bar to bring up the CH1 Settings window.</li><li>2. Click Display switch in the menu to highlight it.</li><li>3. Select coupling mode in the Coupling option.<ul style="list-style-type: none"><li>• Select DC to set to DC Coupling mode. Both DC and AC components contained in the measured signal can be passed through.</li><li>• Select AC to set to AC Coupling mode. DC components contained in the measured signal will be blocked.</li><li>• Select Ground to set to Ground Coupling mode. Disconnect the input signal.</li></ul></li></ol>
Set waveform inversion	<ol style="list-style-type: none"><li>1. Click the CH1 information display bar to bring up the CH1 Settings window.</li><li>2. Click Display switch in the menu to highlight it.</li><li>3. Click Inverted switch to highlight it, the waveform inversion will be enabled. Click Inverted switch gain to gray it, the waveform inversion will be disabled.</li></ol>
Adjust Probe Ratio	<p>It is required to adjust the coefficient of the probe attenuation ratio in the channel operation menu (see “To set the Probe Attenuation Coefficient” on page 20).</p> <p>If the probe attenuation coefficient is 1:1, the input channel ratio of the channel shall also be set to 1 X, so as to avoid errors in the displayed gear factors and measured data.</p> <ol style="list-style-type: none"><li>1. Click the CH1 information display bar to bring</li></ol>

---

---

	up the CH1 Settings window.
	2. Click Display switch in the menu to highlight it.
	3. Select 10X in the Probe Attenu option.

---

Set channel label	1. Click the CH1 information display bar to bring up the CH1 Settings window.
	2. Click Display switch in the menu to highlight it.
	3. Click Label switch to highlight it. According to the requirement by selecting Common or Custom mode to set the channel label.

---

Set amplitude unit	1. Click the CH1 information display bar to bring up the CH1 Settings window.
	2. Click Display switch in the menu to highlight it.
	3. Click Unit menu, the optional units are V, A, W and U. Default unit is V.

---

Set bandwidth limit	1. Click the CH1 information display bar to bring up the CH1 Settings window.
	2. Click Display switch in the menu to highlight it.
	3. Select the oscilloscope bandwidth in the Limit option.
	<ul style="list-style-type: none"><li>• Click 20 MHz. The bandwidth is limited to 20 MHz and the high-frequency components larger than 20 MHz contained in the measured signal will be blocked.</li><li>• Click All. The high-frequency components contained in the measured signal can be passed through.</li></ul>

---

Set input impedance	<ol style="list-style-type: none"><li>1. Click the CH1 information display bar to bring up the CH1 Settings window.</li><li>2. Click Display switch in the menu to highlight it.</li><li>3. Select the oscilloscope input impedance in Input Impedance option.<ul style="list-style-type: none"><li>• Click 1 M<math>\Omega</math>. The oscilloscope input 1 M<math>\Omega</math> resistor, the device will have a small load effect.</li><li>• Click 50 <math>\Omega</math>. The oscilloscope input 50 <math>\Omega</math> resistor, eliminate the influence of the transmission line on the signal.</li></ul></li></ol> <hr/>
Set expand	<ol style="list-style-type: none"><li>1. Click the CH1 information display bar to bring up the CH1 Settings window.</li><li>2. Click Display switch in the menu to highlight it.</li><li>3. Click Expand menu to select the waveform scaling method.<ul style="list-style-type: none"><li>• Click Center. The waveform will be scaled around the vertical center point of the oscilloscope screen.</li><li>• Click Offset. The waveform will be scaled around the channel's vertical zero point (zero level).</li></ul></li></ol> <hr/>
Set voltage scale	<ol style="list-style-type: none"><li>1. Click the CH1 information display bar to bring up the CH1 Settings window.</li><li>2. Click Display switch in the menu to highlight it.</li><li>3. Click the numeric box in the Scale option to display the scale select box. It is available to swipe the screen up and down with the finger to select the required scale value.</li></ol> <hr/>

- Set vertical position
1. Click the CH1 information display bar to bring up the CH1 Settings window.
  2. Click Display switch in the menu to highlight it.
  3. Click the numeric value in the Offset option to display the setup box of vertical position; it is available to directly input the value or turn the general knob to set the required vertical position.

### Application of Math key and Ref key

See “How to realize waveform operation” on page 107 for the Math key.

See “How to set reference waveform” on page 154 for the Ref key.

### Application of Vertical Position knob and Vertical Scale knob

- Vertical Position knob to adjust the vertical position of corresponding channel waveform.
- Vertical Scale knob to adjust the vertical resolution of corresponding channel waveform.

The vertical position and vertical channel information are shown in the lower left of the screen, as shown in Figure 5-4

Figure 5-4

Vertical information

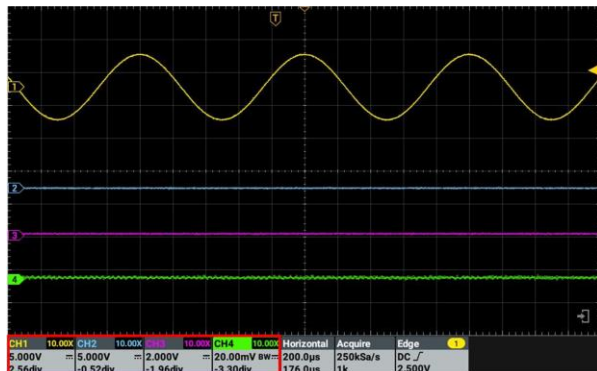

## How to set horizontal system

There are Horizontal Position knob and Horizontal Scale knob in the Horizontal System Control Area.

- Horizontal Position knob: Adjust the horizontal position of all channels (including the mathematical operation), whose resolution changes with the time base.
- Horizontal Scale knob: Set the horizontal scale factor for the main window or amplified window.

The descriptions of horizontal system menu are shown in the table below:

Function Menu	Setting	Description
Zoom Mode		Click to open/close zoom mode.
Navigate		Through the navigation function, observe the situation of moving waveform.  <b>Note:</b> The navigation function is used only when the running status is STOP (Acquire stop).
Expand	Center	Horizontal expansion refers to the reference position on which the screen waveform is horizontally expanded or compressed when the horizontal time base is adjusted. This instrument supports horizontal extension data including centers and trigger points default to "centers". When changing the horizontal time base, the waveform expands or compresses horizontally around the center of the screen.

	Trigger	When the horizontal time base is changed, the waveform expands or compresses horizontally around the trigger point.
Time Base		Set the horizontal time base scale of window.
Offset		Set the horizontal position of windows.

**Waveform Amplification**

Click the panel horizontal control area Horizontal Scale knob or click the Horizontal Information Display Bar at the lower part of the screen, display Horizontal Setting Window, click Zoom Mode switch to highlight it and enter the waveform amplification mode; the main window is displayed at the top half of the screen and the amplified window is displayed at the bottom half of the screen. The amplified window is the amplified part of the main window that is selected.

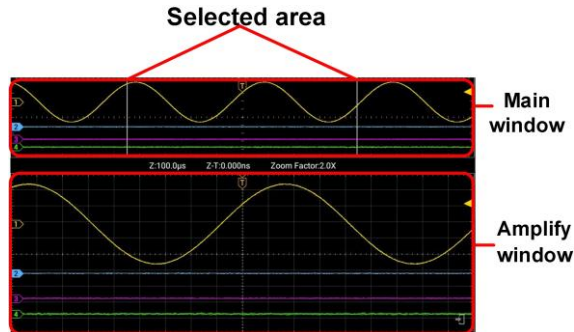







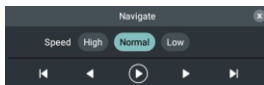







In normal mode, the Horizontal Position knob and the Horizontal Scale knob are used to adjust the horizontal position and the horizontal time base of the main window.

In waveform amplification mode, the Horizontal Position knob and the Horizontal Scale knob are used to adjust the horizontal position and the horizontal time base of the amplified window.

## Navigate function



1. Click the bottom of screen Horizontal Information Display Bar, display horizontal setting window.
2. Click Navigate to enter navigate setting window.
3. Click , ,  can select waveform play speed.
4. Click  or  can start/stop playing.
5. In the run mode: Click , the waveform can play directly to the far left; click  the waveform can play directly to the far right. Click  (Play left) or  (Play right) can change the play direction, and it stops playing when it reaches the leftmost or rightmost end.  
  
In the stop mode: Click , the waveform can play directly to the far left; click  the waveform can play directly to the far right. Click  or  the waveform can be shifted one step to the left / right.
6. Click  can close the navigation setting window and function.



Turning the Trigger Level knob can not only change the trigger level value, but also set the shortcut key of the trigger level at the vertical midpoint of the trigger signal amplitude.



For the operations related to the touch screen, refer to “ How to use touch screen control ” on page 36.

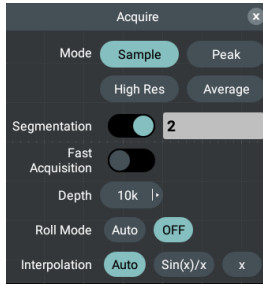

## How to set acquire

Click the bottom of screen Acquire Information Display Bar, the setting window as shown in the figure below.



The descriptions of setting window are shown in the table below:

Function Menu	Setting	Description
Mode	Sample	General Acquisition mode.
	Peak	Used to detect interference burrs and possibility of reduce confusion.
	High Res	Reduce and improve the signal-to-noise ratio on aperiodic (single-shot) waveforms.
	Average	Used to reduce random and irrelevant noise in signal. Click the number input box and scroll down the list to the right to select the average count.
Segmentation		Click to enable/disable the segment acquisition function. When the function is turned on, the segmentation acquire bar will be displayed at the bottom left, click Numeric Input Box to input the number of segment acquisition and click OK to confirm; or click Gear Input Box (- or +) or turn the General knob to set the number of segment acquisition, and click < > or press   to move the cursor and select the digit to be set. When the

		Run/Stop button is pressed to enter the stop state, you can access the recorder player function. For details on “ <b>How to set waveform record/player</b> ”, please refer to page 144. Pressing Run/Stop again will resume segmentation acquire.
Fast Acquisition		This feature is displayed only when segmented acquisition is enabled. When this feature is enabled, it can improve waveform capture rate, but the memory depth cannot be adjusted and is fixed at 1 k. Additionally, when enabled, if the device is in pause mode, the horizontal position, time base, vertical position, voltage scale, and channel switching cannot be adjusted.
Depth	1 k 10 k 100 k 1 M 10 M 100 M 250 M 500 M	Click  , to select the length to be recorded on the right display box.   <b>Note</b> The length of the collected record is dynamic, changing with the number of channels opened. Bandwidth 350 MHz and 500 MHz: up to 500 Mpts in single-channel mode, 250 Mpts in dual-channel mode.
Roll Mode	Auto OFF	As the acquisition proceeds, new data will continue to scroll sideways on the screen. In rolling mode, the oscilloscope samples the waveform without interruption without dead time. The waveform is displayed slowly moving from the right side of the screen to the left, and the fixed reference point on the screen is on the right edge of the screen to indicate the current time. The existing waveform is scrolled to the left of the reference point, and the newly acquired waveform always appears on the right side of the screen.

Interpolation	Auto	When Auto is selected, it is in Sin(x)/x mode when running and in x mode when it stops running.
	Sin(x)/x	Sine interpolation, using a curve connection between the sampling points.
	x	Linear interpolation, using straight line connections between sampling points. This interpolation method is more suitable for signals with straight edges, such as square wave, pulse wave, etc.

## Segmented Acquisition Instructions

Functional Description	<p>Segmented Acquisition (also known as Sequence Mode) is a high-performance waveform capture feature that partitions the oscilloscope's acquisition memory into multiple independent segments.</p> <p>Unlike standard acquisition, which records signals continuously, segmented mode only captures data upon detecting a user-defined trigger event. By bypassing the "dead time" (idle periods or irrelevant signals) between events, it significantly optimizes memory utilization. This allows for the capture of thousands of specific events at high sample rates over extended periods—a capability that standard acquisition cannot achieve. Each captured segment includes a precise timestamp, providing the exact time of occurrence for every event.</p>
Operating Instructions	<ol style="list-style-type: none"> <li>1. Access Settings: Tap the acquisition information bar at the bottom of the screen to enter the Acquisition Settings window.</li> <li>2. Enable Feature: Tap the Segmented Acquisition toggle to highlight it (Set to ON).</li> <li>3. Configure Segments: Once enabled, the trigger mode automatically switches to Normal. A</li> </ol>

“Segments” input field will appear; enter the desired number of segments.

4. Execute Capture: Upon confirmation (e.g., entering 100), the instrument will capture 100 frames of triggered waveforms. Once the acquisition is complete, all 100 frames will be displayed on the screen.
  5. Data Playback: Press the [Run/Stop] key to review and play back the captured data.
-

## How to set trigger

Trigger determines when the oscilloscope starts to collect the data and display the waveform. Once it is set properly, it can convert unstable display into the meaningful waveform.

When the oscilloscope starts to collect the data, enough data are used to draw the waveform at the left of the trigger point. The oscilloscope continuously collects data while waiting for the trigger conditions. When a trigger is detected, the oscilloscope will continuously collect enough data to draw the waveform at the right of the trigger point.

There is one knob and one keys in the Trigger Control Area.

---

- **Trigger Level:** Turn this knob to set the signal voltage of corresponding trigger point and press this knob to make the trigger level at the vertical midpoint of the trigger signal amplitude.
- **Forced Trigger:** Generate a trigger signal forcibly, mainly used in the “Normal” and “Single” trigger mode.

### Trigger Control

Enter the trigger control:

**Trigger Information Display Bar Operation:** Click Edge information display bar at the lower part of the screen to pop up the trigger setting window on the screen, then directly click Type to select the trigger mode.

There are 14 trigger modes, including Edge Trigger, Video Trigger, Pulse Trigger, Slope Trigger, Runt Trigger, Windows Trigger, Timeout Trigger, Nth Edge Trigger, Logic Trigger, RS232/UART Trigger, I<sup>2</sup>C Trigger, SPI Trigger, CAN Trigger and LIN Trigger.





These 14 trigger modes are illustrated as follows.

**Edge Trigger**      Trigger on the trigger level of the input signal edge. When the “Edge Trigger” is selected, it is triggered on the rising edge and falling edge of the input signal.

Enter the edge trigger and the trigger setting information is displayed at the lower part of the screen, such as , indicating that the edge trigger is selected with the trigger signal source of CH1, trigger coupling of DC, slope of rising edge, and trigger level of 1.800 V.

The descriptions of **edge trigger** setting window is shown in the table below:

Function Menu	Setting	Description
Type	Edge	Set the trigger type of the vertical channel to edge trigger.
Source	CH1	Set Channel 1 as the signal source trigger signal.
	CH2	Set Channel 2 as the signal source trigger signal.
	CH3	Set Channel 3 as the signal source trigger signal.
	CH4	Set Channel 4 as the signal source trigger signal.
	EXT	Set the external trigger input channel as the signal source trigger signal.
	EXT/5	Set the external trigger source divided by 5 to extend the external trigger level range.
	AC Lines	Set the mains supply as the trigger signal source.





Coupling	DC	The whole portion (AC and DC) of the signal appears on the display.
	AC	Only the AC portion of the signal appears on the display.
	HF	High-frequency filter for attenuating high-frequency noise.
Slope		Set to trigger at the rising edge of the signal.
		Set to trigger at the falling edge of the signal.
Level	50 %	<p>Indicate the vertical trigger position of the channel, turn trigger level knob or slide your finger up and down to change the trigger level on the right side of the waveform display area of the screen; upon setting, a gray solid line will appear indicating the trigger level position and the trigger level value in the trigger information display box at the bottom edge of the screen will change accordingly. After the setting is completed, the solid line will disappear.</p> <p>Click 50 % and set the shortcut key of trigger level in the vertical midpoint of the trigger signal amplitude.</p>
HoldOff	100 ns	<p>100 ns to 10 s; click Numeric Input Box to input the interval to be set for restarting the trigger circuit and click the unit to confirm; or click Gear Input Box (- or +) or turn the General knob to set the interval for restarting the trigger circuit, and click &lt; &gt; or press   to move the cursor and select the digit to be set.</p> <p>Set the trigger hold-off time as 100ns.</p>
Sensitivity		Set the sensitivity of the trigger window.
Mode	Auto	Set to collect waveform even when no trigger condition is detected.

	Normal	Set to collect waveform only when trigger conditions are satisfied.
	Single	Set to acquire a waveform when one trigger is detected and then stop acquisition.

**Video Trigger** Select the Video Trigger to trigger on standard video signal field or line of 525i/NTSC,625i/PAL or SECAM. Enter the video trigger and the trigger setting information is displayed in the lower part of the screen, such as , indicating that the video trigger is selected with the trigger information source of CH1 and synchronization type of line.







The descriptions of **video trigger** setting window are shown in the table below:

Function Menu	Setting	Description
Type	Video	Set the trigger type of the vertical channel to video trigger.
Source	CH1	Set Channel 1 as the signal source trigger signal.
	CH2	Set Channel 2 as the signal source trigger signal.
	CH3	Set Channel 3 as the signal source trigger signal.
	CH4	Set Channel 4 as the signal source trigger signal.
Coupling	525i/NTSC 625i/PAL SECAM	Set the system standard of the video.
Sync	Line	Set to trigger the synchronization on the video line.
	Field	Set to trigger the synchronization on the video field.
	Odd	Set to trigger the synchronization on the video odd field.

	Even	Set to trigger the synchronization on the video even field.
	Line NO.	Set to trigger the synchronization on the specified video line; click Numeric Input Box to input the number of specified line to be set and click OK to confirm; or click Gear Input Box (- or +) or turn the General knob to set the number of specified line, and click < > or press   to move the cursor and select the digit to be set.
HoldOff		100 ns to 10 s; click Numeric Input Box to input the interval to be set for restarting the trigger circuit and click the unit to confirm; or click Gear Input Box (- or +) or turn the General knob to set the interval for restarting the trigger circuit, and click < > or press   to move the cursor and select the digit to be set.
	100 ns	Set the trigger hold-off time as 100 ns.
Mode	Auto	Set to collect waveform even when no trigger condition is detected.
	Normal	Set to collect waveform only when trigger conditions are satisfied.
	Single	Set to acquire a waveform when one trigger is detected and then stop acquisition.

**Pulse Trigger** Pulse trigger is to determine the trigger moment based on the pulse width. You can discover abnormal pulse by setting the pulse width conditions. Enter the pulse trigger and the trigger setting information is displayed in the lower part of the screen, such as , indicating that the pulse trigger is selected with the trigger signal source of CH1, polarity of positive pulse width and trigger level value of 1.800 V.



The descriptions of **pulse width trigger** setting window are shown in the table below:





Function Menu	Setting	Description
Type	Pulse	Set the trigger type of the vertical channel to pulse trigger.
Source	CH1	Set Channel 1 as the signal source trigger signal.
	CH2	Set Channel 2 as the signal source trigger signal.
	CH3	Set Channel 3 as the signal source trigger signal.
	CH4	Set Channel 4 as the signal source trigger signal.
Polarity		Select the polarity.
Time	> = < Time setting	Click  to set the pulse condition, click time setting's Numeric Input Box to input the pulse width time to be set and click the unit to confirm; or click Gear Input Box (- or +) or turn the General knob to set the pulse width time, and click < > or press   to move the cursor and select the digit to be set.
Threshold	50 %	Click Numeric Display Box and turn General knob to set the upper threshold; Click 50 % and set the shortcut key of trigger level in the vertical midpoint of the trigger signal amplitude.
HoldOff		100 ns to 10 s; click Numeric Input Box to input the interval to be set for restarting the trigger circuit and click the unit to confirm; or click Gear Input Box (- or +) or turn the General knob to set the interval for restarting the trigger circuit, and click < > or press   to move the cursor and select the digit to be set.
	100 ns	Set the trigger hold-off time as 100 ns.

Sensitivity		Set the sensitivity of the trigger window.
Mode	Auto	Set to collect waveform even when no trigger condition is detected.
	Normal	Set to collect waveform only when trigger conditions are satisfied.
	Single	Set to acquire a waveform when one trigger is detected and then stop acquisition.

**Slope Trigger** Slope Trigger is to set the oscilloscope to trigger with the positive or negative slope at a specified time. Enter the slope trigger and the trigger setting information is displayed in the lower part of the screen, such as , indicating that the slope trigger is selected with the trigger signal source of CH1, trigger condition of rising slope and 1.800 V of the difference between the upper threshold and the lower threshold.

The descriptions of **Slope Trigger** setting window are shown in the table below:

Function Menu	Setting	Description
Type	Slope	Set the trigger type of the vertical channel to slope trigger.
Source	CH1	Set Channel 1 as the signal source trigger signal.
	CH2	Set Channel 2 as the signal source trigger signal.
	CH3	Set Channel 3 as the signal source trigger signal.
	CH4	Set Channel 4 as the signal source trigger signal.
Slope	 	Select the slope conditions.



Time	<p>&gt; = &lt; Time setting</p>	<p>Click  to set the slope conditions, click time setting's Numeric Input Box to input the slope time to be set and click the unit to confirm; or click Gear Input Box (- or +) or turn General knob to set the slope time, and click &lt; &gt; or press   to move the cursor and select the digit to be set.</p>
Upper Threshold	50 %	<p>Click Numeric Display Box and turn General knob to set the upper threshold; Click 50 % and set the shortcut key of trigger level in the vertical midpoint of the trigger signal amplitude.</p>
Lower Threshold	50 %	<p>Click Numeric Display Box and turn General knob to set the lower threshold; Click 50 % and set the shortcut key of trigger level in the vertical midpoint of the trigger signal amplitude.</p>
Slew Rate		<p>Slope = (Upper Threshold - Lower Threshold) / Slope Trigger Time</p>
HoldOff	100 ns	<p>100 ns to 10 s; click Numeric Input Box to input the interval to be set for restarting the trigger circuit and click the unit to confirm; or click Gear Input Box (- or +) or turn the General knob to set the interval for restarting the trigger circuit, and click &lt; &gt; or press   to move the cursor and select the digit to be set. Set the trigger hold-off time as 100 ns.</p>
Mode	<p>Auto Normal Single</p>	<p>Set to collect waveform even when no trigger condition is detected. Set to collect waveform only when trigger conditions are satisfied. Set to acquire a waveform when one trigger is detected and then stop acquisition.</p>



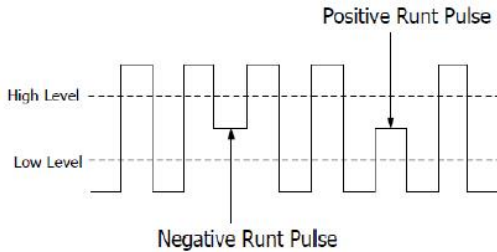

**Runt Trigger**

Used to trigger a pulse that steps over one trigger level but not another. Enter the runt trigger and the trigger setting information is displayed at the lower part of the screen, such as , indicating that the runt trigger is selected with the trigger signal source of CH1, the polarity of positive runt and 1.800 V of the difference between upper level and lower level, as shown in the figure.



The descriptions of **runt trigger** setting window are shown in the table below:





Function Menu	Setting	Description
Type	Runt	Set the trigger type of the vertical channel to under-amplitude trigger.
Source	CH1	Set Channel 1 as the signal source trigger signal.
	CH2	Set Channel 2 as the signal source trigger signal.
	CH3	Set Channel 3 as the signal source trigger signal.
	CH4	Set Channel 4 as the signal source trigger signal.
Polarity		Positive polarity, trigger on the positive under-amplitude pulse.
		Negative polarity, trigger on the negative under-amplitude pulse.



<p>Time</p>	<p>Time setting</p> <p>&gt;</p> <p>=</p> <p>&lt;</p>	<p>Click  to set the pulse width conditions, click time setting's Numeric Input Box to input the pulse width to be set and click the unit to confirm; or click Gear Input Box (- or +) or turn General knob to set the pulse width, and click &lt; &gt; or press   to move the cursor and select the digit to be set.</p> <p>Trigger when runt pulse is greater than the set pulse width.</p> <p>Trigger when runt pulse equals to the set pulse width.</p> <p>Trigger when runt pulse is lower than the set pulse width.</p>
<p>Upper Threshold</p>	<p>50 %</p>	<p>Click Numeric Display Box and turn General knob to set the upper threshold; Click 50 % and set the shortcut key of trigger level in the vertical midpoint of the trigger signal amplitude.</p>
<p>Lower Threshold</p>	<p>50 %</p>	<p>Click Numeric Display Box and turn General knob to set the lower threshold; Click 50 % and set the shortcut key of trigger level in the vertical midpoint of the trigger signal amplitude.</p>
<p>HoldOff</p>	<p>100 ns</p>	<p>100 ns to 10 s; click Numeric Input Box to input the interval to be set for restarting the trigger circuit and click the unit to confirm; or click Gear Input Box (- or +) or turn the General knob to set the interval for restarting the trigger circuit, and click &lt; &gt; or press   to move the cursor and select the digit to be set.</p> <p>Set the trigger hold-off time as 100 ns.</p>
<p>Mode</p>	<p>Auto</p> <p>Normal</p>	<p>Set to collect waveform even when no trigger condition is detected.</p> <p>Set to collect waveform only when trigger conditions are satisfied.</p>

	Single	Set to acquire a waveform when one trigger is detected and then stop acquisition.
--	--------	---

Window Trigger Provide a high trigger level and low trigger level, the oscilloscope triggers when the input signal passes through the high trigger level or the low trigger level. In Windows Trigger mode, the trigger setting information is displayed on bottom right of the screen, for example, , indicates that trigger type is windows, trigger source is CH1, polarity is positive, 1.800 V the differential between up level and low level threshold.



The descriptions of **windows trigger** setting window are shown in the table below:



Function Menu	Setting	Description
Type	Windows	Set vertical channel trigger type as Windows trigger.
Source	CH1	Set Channel 1 as the signal source trigger signal.
	CH2	Set Channel 2 as the signal source trigger signal.
	CH3	Set Channel 3 as the signal source trigger signal.
	CH4	Set Channel 4 as the signal source trigger signal.
Polarity		Positive over-amplitude pulse
		Negative over-amplitude pulse.
Time		Enter: Triggers when the trigger signal enters the specified trigger level range.
		Exit: Triggers when the trigger signal exits the specified trigger level range.
		Time: Specify the hold time of the input signal after entering the specified trigger level. The oscilloscope triggers when the accumulated hold time is

		greater than the windows time. Available range is 30 ns to 10 s, default 100 ns.
Upper Threshold	50 %	Click Numeric Display Box and turn General knob to set the upper threshold; Click 50 % and set the shortcut key of trigger level in the vertical midpoint of the trigger signal amplitude.
Lower Threshold	50 %	Click Numeric Display Box and turn General knob to set the lower threshold; Click 50 % and set the shortcut key of trigger level in the vertical midpoint of the trigger signal amplitude.
HoldOff	100 ns	100 ns to 10 s; click Numeric Input Box to input the interval to be set for restarting the trigger circuit and click the unit to confirm; or click Gear Input Box (- or +) or turn the General knob to set the interval for restarting the trigger circuit, and click < > or press   to move the cursor and select the digit to be set. Set the trigger hold-off time as 100 ns.
Mode	Auto Normal Single	Set to collect waveform even when no trigger condition is detected. Set to collect waveform only when trigger conditions are satisfied. Set to acquire a waveform when one trigger is detected and then stop acquisition.

**Timeout Trigger** Trigger when the interval from the time at which the rising (or falling) edge of the input signal passes through the touch level to the time when the adjacent falling (or rising) edge passes through the touch level is larger than the set timeout period. Enter the timeout trigger and the trigger setting information is displayed at the lower part of the screen, such as , indicating that the timeout trigger type is selected with 1.800 V of the trigger level value.

The descriptions of **timeout trigger** setting window are shown in the table below:





Function Menu	Setting	Description
Type	Timeout	Set the trigger type of the vertical channel as timeout trigger.
Source	CH1	Set Channel 1 as the signal source trigger signal.
	CH2	Set Channel 2 as the signal source trigger signal.
	CH3	Set Channel 3 as the signal source trigger signal.
	CH4	Set Channel 4 as the signal source trigger signal.
Slope		Set to start timing when the rising edge of the input signal passes through the trigger level.
		Set to start timing when the falling edge of the input signal passes through the trigger level.
Idle Time		Set the idle time. It refers to the minimum time that the clock signal must be in idle state before the oscilloscope begins to search for data that meets the trigger conditions. The idle time ranges from 30 ns to 10 s with default value of 100 ns.

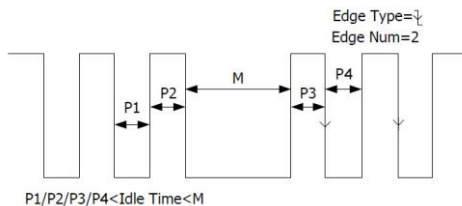



Threshold	50 %	Click Numeric Display Box and turn General knob to set the lower threshold. Click 50 % and set the shortcut key of trigger level in the vertical midpoint of the trigger signal amplitude.
HoldOff	100 ns	100 ns to 10 s; click Numeric Input Box to input the interval to be set for restarting the trigger circuit and click the unit to confirm; or click Gear Input Box (- or +) or turn the General knob to set the interval for restarting the trigger circuit, and click < > or press   to move the cursor and select the digit to be set. Set the trigger hold-off time as 100 ns.
Mode	Auto Normal Single	Set to collect waveform even when no trigger condition is detected. Set to collect waveform only when trigger conditions are satisfied. Set to acquire a waveform when one trigger is detected and then stop acquisition.

**Nth Edge Trigger** The oscilloscope triggers on the Nth edge that appears on the specified idle time. As figure shown below, the oscilloscope should trigger on the second falling edge after the specified idle time and the idle time should be set to  $P1/P2/P3/P4 < \text{Idle Time} < M$ . Wherein, M, P1, P2, P3 and P4 are positive or negative pulse width participating in the counting. In Nth Edge Trigger mode, the trigger setting information is displayed on bottom right of the screen, for example,  indicates that trigger type is Nth Edge, trigger source is CH1, 1.800 V is up level or low level threshold.



The descriptions of the **Nth edge trigger** setting window are shown in the table below:

Function Menu	Setting	Description
Type	Nth Edge	Set vertical channel trigger type as Nth Edge trigger.
Source	CH1	Set Channel 1 as the signal source trigger signal.
	CH2	Set Channel 2 as the signal source trigger signal.
	CH3	Set Channel 3 as the signal source trigger signal.
	CH4	Set Channel 4 as the signal source trigger signal.
Polarity		Trigger on the rising edge of the input signal when voltage level meets the specified trigger level.
		Trigger on the falling edge of the input signal when voltage level meets the specified trigger level.
Idle Time		Set the time before starting the edge counting in the Nth edge trigger. Click Numeric Input Box to input the idle time to be set for restarting the trigger circuit and click the unit to confirm; or click Gear Input Box (- or +) or turn the General knob to set the idle time for restarting the trigger circuit, and click < > or press   to move the cursor and select the digit to be set.

		The time that can be set ranges from 30 ns to 10 s with default value of 100 ns.
Edge Num		Set the specific value of N in the Nth edge trigger. Click Numeric Input Box to input the edge number to be set and click OK to confirm; or click Gear Input Box (- or +) or turn the General knob to set the edge number, and click < > or press   to move the cursor and select the digit to be set.
Threshold	50 %	Click Numeric Display Box and turn General knob to set the required threshold. Click 50 % and set the shortcut key of trigger level in the vertical midpoint of the trigger signal amplitude.
HoldOff		100 ns to 10 s; click Numeric Input Box to input the interval to be set for restarting the trigger circuit and click the unit to confirm; or click Gear Input Box (- or +) or turn the General knob to set the interval for restarting the trigger circuit, and click < > or press   to move the cursor and select the digit to be set.
	100 ns	Set the trigger hold-off time as 100 ns.
Mode	Auto	Set to collect waveform even when no trigger condition is detected.
	Normal	Set to collect waveform only when trigger conditions are satisfied.
	Single	Set to acquire a waveform when one trigger is detected and then stop acquisition.











**Logic Trigger** Determine the trigger conditions with the logical relations. Enter the logic trigger and the trigger setting information is displayed at the lower part of the screen, such as , indicating that the logic trigger type is selected with the logic mode of AND, input mode of high level and output mode of Goes True.







**Note**

When a rising or falling edge is set for one channel, it can not do the same for another.

The descriptions of the **Logic trigger** setting window are shown in the table below:

Function Menu	Setting	Description
Type	Logic	Set vertical channel trigger type as Logic trigger.
Logic Mode	AND  OR  XOR  XNOR 	Set logic mode as AND. Set logic mode as OR. Set logic mode as XOR. Set logic mode as XNOR.
CH1 Input Mode	1 0 X  	Set CH1 as High Level, Low level, high or low level, Rise and Fall.
CH2 Input Mode	1 0 X  	Set CH2 as High Level, Low level, high or low level, Rise and Fall.
CH3 Input Mode	1 0 X  	Set CH3 as High Level, Low level, high or low level, Rise and Fall.

CH4 Input Mode	<p>1</p> <p>0</p> <p>X</p>  	Set CH4 as High Level, Low level, high or low level, Rise and Fall.
Output Mode	<p>GoesTrue</p> <p>GoesFalse</p> <p>True&gt;</p> <p>True=</p> <p>True&lt;</p>	<p>Click  to select the output mode.</p> <p>GoesTrue: Trigger when condition turns True from False.</p> <p>GoesFalse: Trigger when condition turns False from True.</p> <p>True &gt;: Trigger when the time of true condition is more than the set time.</p> <p>True =: Trigger when the time of true condition is equal to the set time.</p> <p>True &lt;: Trigger when the time of true condition is lower than the set time.</p>
CH1 Threshold	50 %	<p>Click Numeric Display Box and turn General knob to set the CH1 Threshold.</p> <p>Click 50 % and set the shortcut key of trigger level in the vertical midpoint of the trigger signal amplitude.</p>
CH2 Threshold	50 %	<p>Click Numeric Display Box and turn General knob to set the CH2 Threshold.</p> <p>Click 50 % and set the shortcut key of trigger level in the vertical midpoint of the trigger signal amplitude.</p>
CH3 Threshold	50 %	<p>Click Numeric Display Box and turn General knob to set the CH3 Threshold.</p> <p>Click 50 % and set the shortcut key of trigger level in the vertical midpoint of the trigger signal amplitude.</p>

CH4 Threshold	50 %	Click Numeric Display Box and turn General knob to set the CH4 Threshold. Click 50% and set the shortcut key of trigger level in the vertical midpoint of the trigger signal amplitude.
HoldOff		100 ns to 10 s; click Numeric Input Box to input the interval to be set for restarting the trigger circuit and click the unit to confirm; or click Gear Input Box (- or +) or turn the General knob to set the interval for restarting the trigger circuit, and click < > or press   to move the cursor and select the digit to be set.
	100 ns	Set the trigger hold-off time as 100 ns.
Mode	Auto	Set to collect waveform even when no trigger condition is detected.
	Normal	Set to collect waveform only when trigger conditions are satisfied.
	Single	Set to acquire a waveform when one trigger is detected and then stop acquisition.

**RS232/ UART Trigger**



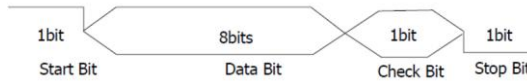

RS232/UART bus is a serial data communication mode used for data transmission between computers or between the computer and the terminal. RS232 serial protocol transmit a character as a frame of data, the frame structure is composed of 1 start bit, 5 to 8 data bits, 1 check bit and 1 to 2 stop bit(s), with the format as shown in the figure below. It is triggered when a start frame, error frame, check error or specified data is detected.

Enter the RS232/UART bus trigger and the trigger setting information is displayed at the lower part of the screen, such as , indicating that the RS232/UART trigger mode is selected with the



trigger signal source of CH1, CH1 baud rate of 9.6 kps and CH1 trigger level of 1.800 V.



The descriptions of **RS232 trigger** setting window are shown in the table below:

Function Menu	Setting	Description
Type	RS232/ UART	Set the bus trigger type to RS232/UART trigger.
Source	CH1	Set Channel 1 as the signal source trigger signal.
	CH2	Set Channel 2 as the signal source trigger signal.
	CH3	Set Channel 3 as the signal source trigger signal.
	CH4	Set Channel 4 as the signal source trigger signal.
Polarity		Select positive polarity for data transmission.
		Select reverse polarity for data transmission.
Baud	Common	Click Numeric Display Box and turn General knob to set the commonly-used baud rate.
	Custom	Click Numeric Display Box to input the baud rate to be set and click unit to confirm; or click Gear Input Box (- or +) or turn the General knob to set the baud rate, and click < > or press   to move the cursor and select the digit to be set. The baud rate ranges from 50 to 10,000,000.

Threshold	50 %	<p>Click Numeric Display Box and turn General knob to set the required threshold.</p> <p>Click 50 % and set the shortcut key of trigger level in the vertical midpoint of the trigger signal amplitude.</p>
Condition	Start	<p>Trigger when a start frame is detected, and set after selecting this trigger condition:</p> <p>Stop Bit: Select "1 bit" or "2 bits".</p> <p>Parity: "None" refers to no check; "Even" refers to even check and "Odd" refers to odd check.</p>
	Error	<p>Trigger when an error frame is detected, and set after selecting this trigger condition:</p> <p>Stop Bits: Select "1 bit" or "2 bits".</p> <p>Parity: "None" refers to no check; "Even" refers to even check and "Odd" refers to odd check; the oscilloscope determines if there is any check error based on this setting.</p>
	Chk Error	<p>Trigger when a check error is detected. After selecting this trigger conditions, click Parity to select even check or odd check.</p>
	Data	<p>Trigger at the last bit of the set data bit and set after selecting this trigger condition:</p> <p>Data Bits: Set to 5, 6, 7, or 8 bits.</p> <p>Data: Based on the set data bit width, the data range is between 0 and 2 data bits width power -1.</p>

HoldOff	100 ns	100 ns to 10 s; click Numeric Input Box to input the interval to be set for restarting the trigger circuit and click the unit to confirm; or click Gear Input Box (- or +) or turn the General knob to set the interval for restarting the trigger circuit, and click < > or press   to move the cursor and select the digit to be set. Set the trigger hold-off time as 100 ns.
Mode	Auto Normal Single	Set to collect waveform even when no trigger condition is detected. Set to collect waveform only when trigger conditions are satisfied. Set to acquire a waveform when one trigger is detected and then stop acquisition.

**I<sup>2</sup>C Trigger**

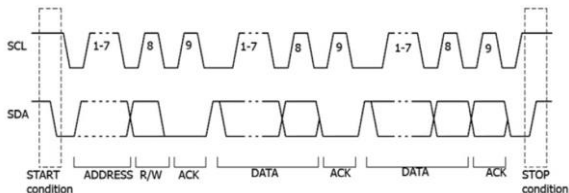

I<sup>2</sup>C serial bus consists of two lines, SCL and SDA, with the transmission rate determined by the clock line SCL and transmission data by SDA, as shown in the figure, it can be triggered upon start, restart, stop, loss confirmation and specific equipment address or data value.

Enter the I<sup>2</sup>C bus trigger and the trigger setting information is displayed at the lower part of the screen, such as , indicating that the I<sup>2</sup>C trigger type is selected with CH1 SCL trigger level of 400.0 mV and CH2 SDA trigger level of 464.0 mV.



The descriptions of I<sup>2</sup>C trigger setting window are shown in the table below:

Function Menu	Setting	Description
Type	I <sup>2</sup> C	Set the bus trigger type to I <sup>2</sup> C.
SCL	CH1	Set Channel 1 as SCL.
	CH2	Set Channel 2 as SCL.
	CH3	Set Channel 3 as SCL.
	CH4	Set Channel 4 as SCL.
Threshold	50 %	Click Numeric Display Box and turn General knob to set the SCL threshold. Click 50 % and set the shortcut key of trigger level in the vertical midpoint of the trigger signal amplitude.
SDA	CH1	Set Channel 1 as SDA.
	CH2	Set Channel 2 as SDA.
	CH3	Set Channel 3 as SDA.
	CH4	Set Channel 4 as SDA.
Threshold	50 %	Click Numeric Display Box and turn General knob to set the SDA threshold. Click 50 % and set the shortcut key of trigger level in the vertical midpoint of the trigger signal amplitude.
Condition	Start	Trigger when SCL is in high level and SDA is from high level to low level.
	Restart	Trigger when another starting condition occurs before the stopping condition.
	Stop	Trigger when SCL is in high level and SDA is from low level to high level.

	Ack Lost	Trigger when SDA data is in high level during any SCL clock bit period.
		Trigger to search for the address value set on the read/write bit.
	Addr Bits	Set the address bit width to "7-bit", "8-bit" or "10-bit".
	Addr	The address ranges from 0 to 127, from 0 to 255 and from 0 to 1023 depending on the address bit width.
	Direction	Set the data direction to read or write. Note: This setting is not available when the address bit width is 8.
		Search for the set data value on the data line and trigger on the edge of the last clock line in the data.
	Data Byte Length	Set the byte length of the data ranging from 1 byte to 5 bytes. Turn General knob to set it.
	Data	Set the data code type on current data bit.
	Addr/Data	Search for the set address value and data value simultaneously and trigger when both meet the trigger conditions; for specific settings, refer to the setting of address format and data format.
HoldOff		100 ns to 10 s; click Numeric Input Box to input the interval to be set for restarting the trigger circuit and click the unit to confirm; or click Gear Input Box (- or +) or turn the General knob to set the interval for restarting the trigger circuit, and click < > or press   to move the cursor and select the digit to be set.
	100 ns	Set the trigger hold-off time as 100 ns.

Sensitivity		Set the sensitivity of the trigger window.
Mode	Auto	Set to collect waveform even when no trigger condition is detected.
	Normal	Set to collect waveform only when trigger conditions are satisfied.
	Single	Set to acquire a waveform when one trigger is detected and then stop acquisition.

**SPI Trigger** When the timeout condition is met, the oscilloscope triggers upon detecting the specified data. In SPI triggering, the CLK and MOSI/MISO signals must be defined.





After entering SPI bus trigger mode, the trigger configuration is displayed at the bottom of the screen, as shown in the figure . It indicates that the trigger type is SPI, with CH1 assigned as CLK and CH2 as MOSI/MISO.

The descriptions of **SPI Trigger** setting window are as follows:

Function Menu	Setting	Description
Type	SPI	Set the trigger type of the vertical channel to SPI trigger.
Mode	Timeout CS	Set SPI trigger mode to Timeout or CS.

When the mode is set to Timeout:



CLK	CH1	Set Channel 1 as the CLK source.
	CH2	Set Channel 2 as the CLK source.
	CH3	Set Channel 3 as the CLK source.
	CH4	Set Channel 4 as the CLK source.
Threshold	50 %	Click Numeric Display Box and turn General knob to set the CLK threshold. Click 50 % and set the shortcut key of trigger level in the vertical midpoint of the trigger signal amplitude.
MISO/MOSI	CH1	Set Channel 1 as the MISO/MOSI source.

	CH2 CH3 CH4	Set Channel 2 as the MISO/MOSI source. Set Channel 3 as the MISO/MOSI source. Set Channel 4 as the MISO/MOSI source.
Threshold	50 %	Click Numeric Display Box and turn General knob to set the MISO/MOSI threshold. Click 50 % and set the shortcut key of trigger level in the vertical midpoint of the trigger signal amplitude.
Timeout		Set the minimum idle period that is, one SCL cycle ranging from 30 ns to 10 s with default value of 100 ns. Timeout occurs when the SDA meeting the trigger conditions is found by the oscilloscope after the SCL signal remains idle for a specified time; Click Numeric Input Box to input the timeout period to be set and click the unit to confirm; or click Gear Input Box (- or +) or turn General knob to set the timeout period, click < > or press   to move the cursor and select the digit to be set. For idle state value, press   to move the cursor and select the digit to be set.

When the mode is set to CS:

CLK	CH1 CH2 CH3 CH4	Set Channel 1 as the CLK source. Set Channel 2 as the CLK source. Set Channel 3 as the CLK source. Set Channel 4 as the CLK source.
Threshold	50 %	Click Numeric Display Box and turn General knob to set the CLK threshold. Click 50 % and set the shortcut key of trigger level in the vertical midpoint of the trigger signal amplitude.
MISO/MOSI	CH1 CH2	Set Channel 1 as the MISO/MOSI source. Set Channel 2 as the MISO/MOSI source.

	CH3 CH4	Set Channel 3 as the MISO/MOSI source. Set Channel 4 as the MISO/MOSI source.
Threshold	50 %	Click Numeric Display Box and turn General knob to set the MISO/MOSI threshold. Click 50 % and set the shortcut key of trigger level in the vertical midpoint of the trigger signal amplitude.
CS	CH1 CH2 CH3 CH4 Active High Active Low	Select CH1, CH2, CH3, or CH4 for CS mode. Select Active High or Active Low for CS mode.
Threshold	50 %	Click Numeric Display Box and turn General knob to set the CS threshold. Click 50 % and set the shortcut key of trigger level in the vertical midpoint of the trigger signal amplitude.
Clock Edge		Set the clock edge to rising edge or falling edge. The rising edge refers to acquire the SDA at the rising edge of the clock; the falling edge refers to acquire the SDA at the falling edge of the clock.
Data Bits		Set the number of bits in the serial data string ranging from 4 to 32 bits; click Numeric Display Box and turn General Knob to set the data bit width.
Data		Set the data bit.
Endian	LSB MSB	Set the bit order to LSB or MSB.
HoldOff		100 ns to 10 s; click Numeric Input Box to input the interval to be set for restarting the trigger circuit and click the unit to confirm; or click Gear Input Box (- or +) or turn the General knob to

	100 ns	set the interval for restarting the trigger circuit, and click < > or press   to move the cursor and select the digit to be set. Set the trigger hold-off time as 100 ns.
Sensitivity		Set the sensitivity of the trigger window.
Mode	Auto	Set to collect waveform even when no trigger condition is detected.
	Normal	Set to collect waveform only when trigger conditions are satisfied.
	Single	Set to acquire a waveform when one trigger is detected and then stop acquisition.

**CAN Trigger**





CAN, the abbreviation of Controller Area Network, is the serial communication protocol of ISO international standardization.

In CAN bus trigger mode, it can be triggered upon Start, Type, ID, Data, ID/Data, End, Lost or Error. It is required to specify the signal source, signal type, acquisition point and signal rate.



Enter the CAN bus trigger and the trigger setting information is displayed at the lower right of the screen, such as , indicating that the CAN trigger type is selected with the trigger signal source of CH1, frame type of CAN\_H and the baud rate of 1,000,000 bps.

The descriptions of **CAN trigger** setting window are as follows:

Function Menu	Setting	Description
Type	CAN	Set the bus trigger type as CAN.
Source	CH1	Set Channel 1 as the signal source trigger signal.
	CH2	Set Channel 2 as the signal source trigger signal.

	CH3	Set Channel 3 as the signal source trigger signal.
	CH4	Set Channel 4 as the signal source trigger signal.
Type	CAN_H CAN_L TX RX  DIFF	Actual CAN_H bus signal. Actual CAN_L bus signal. Sending signal from CAN signal line. Receiving signal from CAN signal line.  Use a differential probe to connect to the analog channel's CAN differential bus signal. Connect the positive terminal of the differential probe to the CAN_H bus signal, and the negative terminal to the CAN_L bus signal.
Sample Point		Click Numeric Input Box to input the point within the bit time to be set and click % to confirm; or click Gear Input Box (- or +) or turn General knob to set the point within the bit time, click < > or press   to move the cursor and select the digit to be set. The oscilloscope starts acquisition to bit level at this point. The position of acquisition point is indicated with the percentage of "bit start to acquisition point" to "bit time", ranging from 0.5 % to 95 %.
Baud	Common	Click Numeric Display Box and turn General knob to select the baud rate from the table.
	Custom	Click Numeric Display Box to input the baud rate to be set and click the unit to confirm; or click Gear Input Box (- or +) or turn the General knob to set the baud rate, and click < > or press   to move the cursor and select the digit to be set. Set the baud rate ranging from 10,000 to 1,000,000.

Threshold	50 %	Click Numeric Display Box and turn General knob to set the required threshold. Click 50 % and set the shortcut key of trigger level in the vertical midpoint of the trigger signal amplitude.			
Condition	Start	Trigger at the frame start bit of the data frame.			
	Type	Type	Data Remote Error Overload	Trigger on the selected frame type.	
	ID	ID Format	Standard Extend	Select the ID format as standard or extended.	
		ID Value		Use the General knob and arrow keys on the panel to set the ID value required.	
	Data	Byte Length		Click Numeric Display Box and select the byte length required for the set data, ranging from 1 to 8.	
		Data		Use the General knob and arrow keys on the panel to set the value required for the data.	
	ID/Data	ID Format	Standard Extend	Select the ID format as standard or extended.	
		ID Value		Use the General knob and arrow keys on the panel to set the ID value required.	
		Byte Length		Click Numeric Display Box and select the byte length required for the set data, ranging from 1 to 8.	

		Data	Use the General knob and arrow keys on the panel to set the value required for the data.
	End	Trigger at the frame end bit of the data frame.	
	Lost	Set the trigger condition to loss confirmation.	
	Error	Set the trigger condition to padding error.	
HoldOff		100 ns to 10 s; click Numeric Input Box to input the interval to be set for restarting the trigger circuit and click the unit to confirm; or click Gear Input Box (- or +) or turn the General knob to set the interval for restarting the trigger circuit, and click < > or press   to move the cursor and select the digit to be set.	
	100 ns	Set the trigger hold-off time as 100 ns.	
Sensitivity		Set the sensitivity of the trigger window.	
Mode	Auto	Set to collect waveform even when no trigger condition is detected.	
	Normal	Set to collect waveform only when trigger conditions are satisfied.	
	Single	Set to acquire a waveform when one trigger is detected and then stop acquisition.	

**LIN Trigger**

The LIN bus data frame format is shown in the figure below:

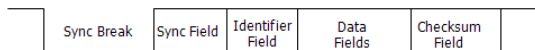





Trigger with LIN bus based on signal Break, ID, ID/data and Data Error. The signal source and signal rate specified by LIN is required.

Enter the LIN bus trigger and the trigger setting information is displayed at the lower right of the

screen, such as , indicating that the LIN trigger type is selected with the trigger signal source of CH1, baud rate of 1,200 bps and trigger level of 1.800 V.

The descriptions of **LIN trigger** setting window are as follows:

Function Menu	Setting	Description
Type	LIN	Set the bus trigger type as LIN.
Source	CH1	Set Channel 1 as the signal source trigger signal.
	CH2	Set Channel 2 as the signal source trigger signal.
	CH3	Set Channel 3 as the signal source trigger signal.
	CH4	Set Channel 4 as the signal source trigger signal.
Baud	Common	Click Numeric Display Box and turn General knob to select the baud rate from the table.
	Custom	Click Numeric Display Box to input the baud rate to be set and click the unit to confirm; or click Gear Input Box (- or +) or turn the General knob to set the baud rate, and click < > or press   to move the cursor and select the digit to be set. Set the baud rate ranging from 50 bps to 20 kbps.
Threshold	50 %	Click Numeric Display Box and turn General knob to set the required threshold. Click 50 % and set the shortcut key of trigger level in the vertical midpoint of the trigger signal amplitude.
Condition	Break	Trigger at the frame start bit of the data frame.

	ID	ID	Use General knob and arrow keys on the panel to set the ID valued required.
	ID/Data	ID	Use General knob and arrow keys on the panel to set the ID valued required.
		Byte Length	Use the General knob to specify the length of the data in bytes, ranging from 1 to 8.
		Data	Use General knob and arrow keys on the panel to set the ID valued required.
	Data Error	Set the trigger condition to bit data error.	
HoldOff	100 ns	100 ns to 10 s; click Numeric Input Box to input the interval to be set for restarting the trigger circuit and click the unit to confirm; or click Gear Input Box (- or +) or turn the General knob to set the interval for restarting the trigger circuit, and click < > or press   to move the cursor and select the digit to be set. Set the trigger hold-off time as 100 ns.	
Sensitivity		Set the sensitivity of the trigger window.	
Mode	Auto	Set to collect waveform even when no trigger condition is detected.	
	Normal	Set to collect waveform only when trigger conditions are satisfied.	
	Single	Set to acquire a waveform when one trigger is detected and then stop acquisition.	

## Introduction to Built-in Analysis Modules

The built-in analysis modules include the following: Measure, XY Mode, Cursor, Math, FFT, Magnifier, Filters, FRA (for GDS-2000HG Series only), Pass/Fail, Counter, DVM, Decode and Record.

## How to set automatic measurement

Press Measure key or click  and select Measure menu to conduct automatic measurement; there are 43 kinds of measurement including horizontal measurement, vertical measurement, Blend measurement and Inter-CH measurement, and a maximum of 8 measuring types can be displayed at the lower left of the screen.

Horizontal Measurement includes	Period, + Width, Rise Time, +Duty, Frequency, - Width, Fall Time, -Duty and ScrDuty.
Vertical Measurement includes	Vavg, Vpp, Vamp, StdDev, Vmax, Vtop, VRMS, Overshoot, Vmin, Vbase, CycRms and Preshoot.
Blend Measurement includes	+PulseCnt, -PulseCnt, RiseCnt, FallCnt, Area and CycArea
Inter-channel Measurement includes	Delay(1 $\Psi$ -2 $\Psi$ ), Delay(1 $\Psi$ -2 $\Psi$ ), Delay(1 $\Psi$ -2 $\Psi$ ), Delay(1 $\Psi$ -2 $\Psi$ ), Phase(1 $\Psi$ -2 $\Psi$ ), Phase(1 $\Psi$ -2 $\Psi$ ), Phase(1 $\Psi$ -2 $\Psi$ ), Phase(1 $\Psi$ -2 $\Psi$ ), FRR(1 $\Psi$ -2 $\Psi$ ), FRR(1 $\Psi$ -2 $\Psi$ ), FFR(1 $\Psi$ -2 $\Psi$ ), FFR(1 $\Psi$ -2 $\Psi$ ), FFF(1 $\Psi$ -2 $\Psi$ ), LRR(1 $\Psi$ -2 $\Psi$ ), LRF(1 $\Psi$ -2 $\Psi$ ), LRF(1 $\Psi$ -2 $\Psi$ ) and LFF(1 $\Psi$ -2 $\Psi$ ).

The descriptions of automatic measurement setting window is shown as follows:

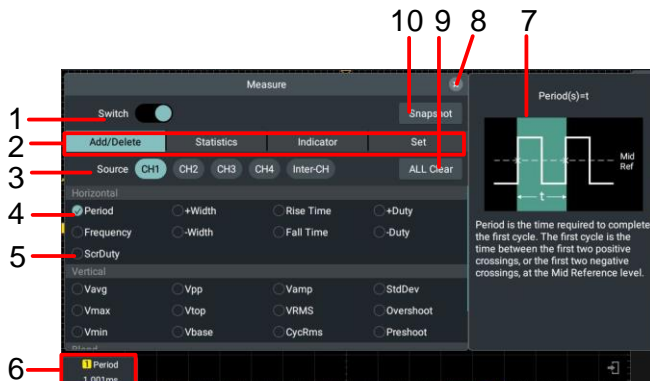

No.	Description
1	Switch, the current state is On; and the measurement is off when the circle is gray.
2	Setting measuring menu.
3	Select signal source CH1, CH2, CH3 and CH4 or between channels. Select the corresponding signal source to highlight the signal source and display corresponding measuring type. Current state is CH1 signal source being selected.
4	It indicates that the current measuring type is added.
5	It indicates that the current measuring type is not added.
6	It indicates the display box of current measuring value type and measuring result display box.
7	The currently selected measurement type is interpreted.
8	Click to close measuring menu.
9	Click to delete all added measuring types.
10	Click to display all measuring values of current opened channel.

## Add/Delete

The waveform channel must be opened for measurement. Automatic measurement can not be performed when storing the waveform or calculating double waveforms. In slow sweep, both the cycle and frequency can not be measured.

Example	<p>To measure the cycle and +Width of CH1 channel signal, operate according to the following steps:</p> <ol style="list-style-type: none"> <li>1. Press Measure key and the setting window is displayed on the screen.</li> <li>2. Click the Switch to On state and the circle is highlighted.</li> <li>3. Click Signal Source CH1 to highlight it.</li> <li>4. Click Period in the horizontal measurement, and the circle is checked and highlighted.</li> </ol>
---------	---

The measured values will be automatically displayed at the lower left of the screen. See No. 6 on page 90.

**Automatic Measurement of Horizontal Parameters**

The oscilloscopes provide time parameters auto-measurements include Period, Frequency, Rise Time, Fall Time, +Width, -Width, +Duty, -Duty, and ScrDuty.

Figure 5-7

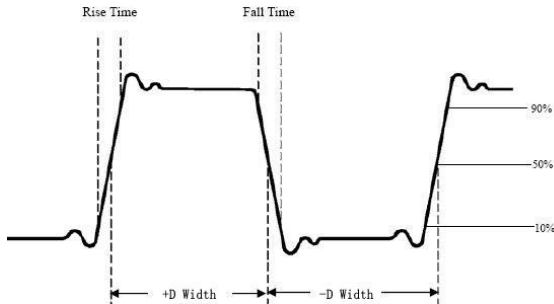

Rise Time	Time that the leading edge of the first pulse in the waveform takes to rise from 10 % to 90 % of its amplitude.
Fall Time	Time that the falling edge of the first pulse in the waveform takes to fall from 90 % to 10 % of its amplitude.
+Width	The width of the first positive pulse in 50 % amplitude points.
-Width	The width of the first negative pulse in the 50 % amplitude points.
+Duty	+Duty Cycle, defined as +Width/Period.
-Duty	-Duty Cycle, defined as -Width/Period.
ScrDuty	Defines as (the width of the positive pulse)/(Entire period).

## Automatic Measurement of Vertical Parameters

The oscilloscopes provide automatic voltage measurements including  $V_{avg}$ ,  $V_{pp}$ ,  $V_{amp}$ ,  $StdDev$ ,  $V_{max}$ ,  $V_{top}$ ,  $VRMS$ ,  $Overshoot$ ,  $V_{min}$ ,  $V_{base}$ ,  $CycRms$  and  $Preshoot$ . The following figure illustrates the physical significance of a set of voltage parameters.

Figure 5-8

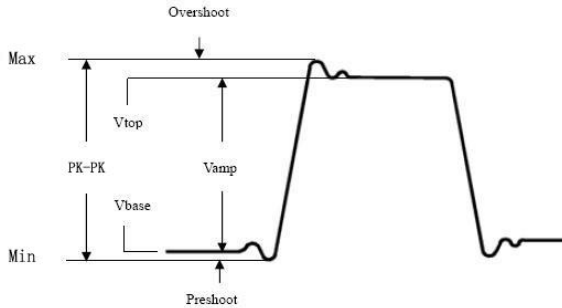







$V_{avg}$	The arithmetic mean over the entire waveform.
$V_{pp}$	Peak-to-Peak Voltage.
$VRMS$	The true Root Mean Square voltage over the entire waveform.
$Overshoot$	Defined as $(V_{max}-V_{top})/V_{amp}$ , useful for square and pulse waveforms.
$V_{max}$	The maximum amplitude. The most positive peak voltage measured over the entire waveform.
$V_{min}$	The minimum amplitude. The most negative peak voltage measured over the entire waveform.
$V_{top}$	Voltage of the waveform's flat top, useful for square/pulse waveforms.
$CycRms$	The true Root Mean Square voltage over the first entire period of the waveform.
$V_{base}$	Voltage of the waveform's flat base, useful for square/pulse waveforms.
$V_{amp}$	Voltage between $V_{top}$ and $V_{base}$ of a waveform.

Preshoot	Defined as $(V_{min}-V_{base})/V_{amp}$ , useful for square and pulse waveforms.
StdDev	Calculate the arithmetic square root of the mean of the square of the difference between each data piece of the waveform and its mean.

## Blend Measurement

---

+PulseCnt		The number of positive pulses that rise above the mid reference crossing in the waveform.
-PulseCnt		The number of negative pulses that fall below the mid reference crossing in the waveform.
RiseCnt		The number of positive transitions from the low reference value to the high reference value in the waveform.
FallCnt		The number of negative transitions from the high reference value to the low reference value in the waveform.
Area		The area of the whole waveform within the screen and the unit is voltage-second. The area measured above the zero reference (namely the vertical offset) is positive; the area measured below the zero reference is negative. The area measured is the algebraic sum of the area of the whole waveform within the screen.
CycArea		The area of the first period of waveform on the screen and the unit is voltage-second. The area above the zero reference (namely the vertical offset) is positive and the area below the zero reference is negative. The area measured is the algebraic sum of the area of the whole period waveform.



Note

When the waveform on the screen is less than a period, the period area measured is 0.

## Automatic Measurement of Inter-channel Parameters

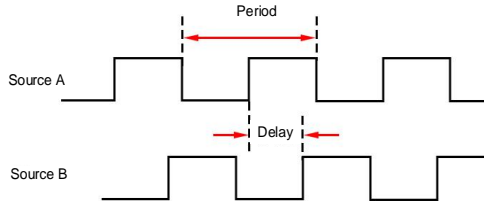

Note for the following measurements:

When source A in the menu is set to CH<n>, source A is CH<n>.

When source B in the menu is set to CH<n>, source B is CH<n>.

- Delay(  $\overline{\text{F}} - \overline{\text{F}}$  )      The time difference between the rising edge of source A and the rising edge of source B at the middle of the threshold. Negative delay indicates that the rising edge of source A occurs after that of source B.
- Delay(  $\overline{\text{F}} - \overline{\text{F}}$  )      The time difference between the falling edge of source A and the falling edge of source B at the middle of the threshold. Negative delay indicates that the falling edge of source A occurs after that of source B.
- Delay(  $\overline{\text{F}} - \overline{\text{F}}$  )      The time difference between the rising edge of source A and the falling edge of source B at the middle of the threshold. Negative delay indicates that the rising edge of source A occurs after the falling edge of source B.
- Delay(  $\overline{\text{F}} - \overline{\text{F}}$  )      The time difference between the lower rising edge of source A and the upper falling edge of source B at the middle value of the threshold. Negative delay indicates that the lower rising edge of source A occurs after the upper falling edge of source B.

Phase( $\uparrow - \uparrow$ ) The phase difference between the rising edge of source A and the rising edge of source B at the middle value of the threshold is expressed in degrees. Calculation formula is:

$$Phase_{A_R B_R} = \frac{Delay_{A_R B_R}}{Period_{sourceA}} \times 360^\circ$$

Of which,  $Phase_{A_R B_R}$  is phase ( $\uparrow - \uparrow$ ),  $Delay_{A_R B_R}$  is delay ( $\uparrow - \uparrow$ ),  $Period_{sourceA}$  is source A period.

Phase( $\downarrow - \downarrow$ ) The phase difference between the falling edge of source A and the falling edge of source B at the middle value of the threshold is expressed in degrees. Calculation formula is:

$$Phase_{A_F B_F} = \frac{Delay_{A_F B_F}}{Period_{sourceA}} \times 360^\circ$$

Of which,  $Phase_{A_F B_F}$  is phase ( $\downarrow - \downarrow$ ),  $Delay_{A_F B_F}$  is delay ( $\downarrow - \downarrow$ ),  $Period_{sourceA}$  is source A period.

Phase( $\uparrow - \downarrow$ ) The phase difference between the rising edge of source A and the falling edge of source B at the middle value of the threshold is expressed in degrees. Calculation formula is:

$$Phase_{A_R B_F} = \frac{Delay_{A_R B_F}}{Period_{sourceA}} \times 360^\circ$$

Of which,  $Phase_{A_R B_F}$  is phase ( $\uparrow - \downarrow$ ),  $Delay_{A_R B_F}$  is delay ( $\uparrow - \downarrow$ ),  $Period_{sourceA}$  is source A period.

Phase( $\downarrow - \uparrow$ ) The phase difference between the falling edge of source A and the rising edge of source B at the middle value of the threshold is expressed in degrees. Calculation formula is:

$$Phase_{A_F B_R} = \frac{Delay_{A_F B_R}}{Period_{sourceA}} \times 360^\circ$$

Of which,  $Phase_{A_F B_R}$  is phase ( $\downarrow - \uparrow$ ),  $Delay_{A_F B_R}$  is delay ( $\downarrow - \uparrow$ ),  $Period_{sourceA}$  is source A period.

FRR Time between Source A first rising edge and

	Source B first rising edge.
FRF	Time between Source A first rising edge and Source B first falling edge.
FFR	Time between Source A first falling edge and Source B first rising edge.
FFF	Time between Source A first falling edge and Source B first falling edge.
LRR	Time between Source A first rising edge and Source B last rising edge.
LRF	Time between Source A first rising edge and Source B last falling edge.
LFR	Time between Source A first falling edge and Source B last rising edge.
LFF	Time between Source A first falling edge and Source B last falling edge.

## Statistics

- Step
1. Click Statistics in the setting window, as shown below.



2. Click switch to open or close the statistics display window. This instrument supports statistics and displays the current value of a number of measurement results, as shown in the figure below.

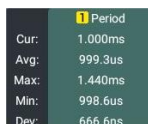

3. Click Avg & Std Sample Times Input Box, set the statistics number by pop up keyboard and also can rotate the corresponding General knob

to set value. The value range of measurement times is 2 to 1000, default is 2.

4. Click Reset, it will clear all measurement of history data and statistics again.

## Indicator

In the Indicator setting window, click Switch, select open or close Indicator function.

If opening Indicator function, screen will appear one or multiple cursor. Before opening Indicator function, you need to open one automatic measurement parameter at least, cursor number will change by measurement parameters.

## Setting



**Horizontal Range** Selecting Screen indicates that the measurement range is the whole screen; selecting Cursor indicates that the measurement range is only within the cursor range.

**Top/Base** Set the measurement method for the top and bottom values of the amplitude. Can choose Auto, Histogram or Min-Max.

**Threshold (Lower Limit < Mid Value < Upper Limit)**

- Click **Upper Limit** Input Box set the statistics number by pop up keyboard and also can rotate the corresponding general knob to set value. When the upper limit value is set to less than or equal to the current median value, the interface prompts “exceed the limit value”, and the instrument automatically adjusts the upper limit value to make it higher than the median value. The default percentage is 90 %,

and the default absolute value changes with the vertical setting of the channel.

- Click **Mid Value** Input Box set the statistics number by pop up keyboard and also can rotate the corresponding general knob to set value. The median value is limited by the upper and lower limits, and the default percentage is 50 %. The default absolute value varies with the vertical setting of the channel.
- Click **Lower Limit** Input Box set the statistics number by pop up keyboard and also can rotate the corresponding general knob to set value. When the current limit value is set to greater than or equal to the current median value, the interface prompts "exceed limit value", and the instrument automatically adjusts the lower limit value to make it lower than the median value. The default percentage is 10 % and the default absolute value changes with the vertical setting of the channel.
- Click **Default** The instrument restores the upper limit, med value, and lower limit to default values.

## How to set XY mode



After XY mode is selected, both Channel 1 and Channel 2 are opened and one waveform amplitude is displayed relative to another. CH1 is displayed on the horizontal axis and CH2 is displayed on the vertical axis.

Horizontal axis can select CH1, CH2, CH3 or CH4.

Vertical axis can select CH1, CH2, CH3 or CH4.

Operations of various control buttons are as follows:

- Use Vertical Scale and Vertical Position knob to set the scale and position in horizontal direction.
- Use Vertical Scale and Vertical Position knob to set the scale and position in vertical direction.

In the XY mode, the following functions are not available:

- Mathematical operation waveform
- FFT
- Filters
- Pass/Fail
- FRA (for GDS-2000HG Series only)

Step

1. Click the main menu window , select XY Mode. Then click Switch to highlight it.
2. Select Full Screen to On status to open the full screen view of XY mode.

## How to set cursor measurement

Press Cursor key, click the main menu window to select Cursor option or click Cursor Shortcut at the upper part of the screen and then click the information display bar in the right of the screen, the cursor information display bar as shown in the figure below.

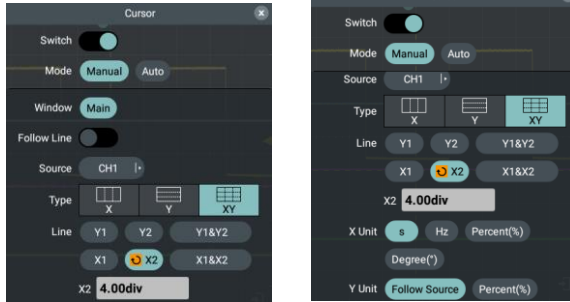

### Cursor Measurement in General Mode

The descriptions of **cursor measurement** setting window are shown in the table below:

Menu	Setting	Description
Switch		Open or close the cursor measurement.
Mode	Manual	Select Cursor Mode.
	Auto	When Auto Mode is selected, the position of the horizontal cursor is automatically set to the intersection of the vertical cursor and the waveform.
Window	Main	Measure the main waveform area Measure other waveform areas
	Other	 Note Only available in XY, Zoom, FFT mode.

Source	Selected Waveform CH1 CH2 CH3 CH4 Math	Select the waveform channel to be measured by the cursor.	
Type	X Y XY	Display time measurement cursor and menu. Display voltage measurement cursor and menu. Display time and voltage measurement cursor and menu.	
Line	X1 X2 X1&X2 Y1 Y2 Y1&Y2 Input Box	Select X1 vertical cursor line. Select X2 vertical cursor line. Select X1 and X2 vertical cursor lines simultaneously. Select a cursor line and turn General knob or drag the cursor line with the finger to move the cursor line. Select Y1 horizontal cursor line. Select Y2 horizontal cursor line. Select Y1 and Y2 horizontal lines simultaneously. Select a cursor line and turn General knob or drag the cursor line with the finger to move the cursor line. Click Input Box to set the cursor position required.	
Unit	X Unit	s Hz Percent (%) Degree(°)	Select the display unit of cursor measurement.
	Y Unit	Follow Source Percent (%)	The display unit of Y cursor display value is subject to the unit of signal source (V.A.W.U) or the percentage.

To conduct cursor measurements of CH1 time and voltage, perform the following operating steps:

---

- |      |  |
|------|--|
| Step | <ol style="list-style-type: none"><li>1. Press Cursor key to pop up cursor measurement setting window. The cursor information display bar located to the right of the waveform display area displays the cursor readings.</li><li>2. In the setting window, select Window as Main.</li><li>3. In the setting window, select Source as Ch1.</li><li>4. Set Cursor Type<ul style="list-style-type: none"><li>• Click X in the type menu to highlight it, and two yellow dotted lines X1 and X2 are displayed in the vertical direction of the screen.</li><li>• Click Y in the type menu to highlight it, and two yellow dotted lines Y1 and Y2 are displayed in the horizontal direction of the screen.</li><li>• Click XY in the type menu, two yellow dotted lines X1 and X2 in the vertical direction and two yellow dotted lines Y1 and Y2 in the horizontal direction are displayed in the screen.</li></ul></li><li>5. Set Cursor Line<ul style="list-style-type: none"><li>• Click Y1 or Y2 in the Cursor Line menu, turn General knob to move the cursor lines Y1 or Y2 up and down; select Y1&amp;Y2 and turn General knob to move the cursor lines Y1 and Y2 up and down simultaneously.</li><li>• Click X1 or X2 in the Cursor Line menu, turn General knob to move the cursor lines X1 or X2 left and right; select X1&amp;X2 and turn General knob to move the cursor lines X1 and X2 left and right simultaneously.</li></ul></li></ol> |
|------|--|
-

Figure 5-9

### Time & Voltage Cursor Measurement

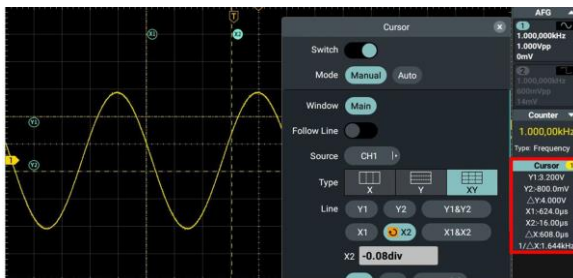

### Use Gestures To Move The Cursor Line

For operating touch screen in cursor measurement, see “Other touch screen operations” on Page 36

### Cursor Measurement in Zoom Mode

To perform a Zoom cursor measurement, perform the following steps:

- Step
  1. Click Zoom shortcut at the top of screen, press Horizontal Scale knob or click the Horizontal Information Display Bar to enter the zoom mode.
  2. Press Cursor key to pop up the cursor measurement setting window. The cursor information display bar located to the right of the waveform display area displays the cursor readings.
  3. In setting window, select Window as Zoom, can make the cursor line appear in the main waveform area or Zoom waveform area.
  4. Set Cursor Type
    - Click X in the type menu to highlight it, and two dotted lines X1 and X2 are displayed in the horizontal direction of the screen.
    - Click Y in the type menu to highlight it, and two dotted lines Y1 and Y2 are displayed in

the horizontal direction of the screen.

- Click XY in the type menu and two dotted lines X1 and X2 in the vertical direction and two dotted lines Y1 and Y2 in the horizontal direction are displayed on the screen.

#### 5. Set Cursor Line

- Click Y1 or Y2 in the cursor line menu and turn General knob to move the cursor lines Y1 or Y2 up and down; select Y1&Y2 and turn General knob to move two cursor lines Y1 and Y2 up and down simultaneously.
  - Click X1 or X2 in the cursor line menu and turn General knob to move the cursor lines X1 or X2 left and right; select X1&X2 and turn General knob to move two cursor lines X1 and X2 left and right simultaneously.
- 

## Cursor Measurement in FFT Mode

To perform a FFT cursor measurement, perform the following steps:

---

- |      |  |
|------|--|
| Step | <ol style="list-style-type: none"><li>1. Click FFT shortcut at the top of screen, then FFT information display bar will display in the bottom of screen, click the information display bar will pop up FFT setting window. You can select Vrms, dBVrms, Radians, Degrees in Vertical Units.</li><li>2. Press Cursor key to pop up the cursor measurement setting window. The cursor information display bar located to the right of the waveform display area displays the cursor readings.</li><li>3. In setting window,select Window as FFT, can make the cursor line appear in the main waveform area or FFT waveform area.</li><li>4. Set Cursor Type<ul style="list-style-type: none"><li>• Click X in the type menu to highlight it, and</li></ul></li></ol> |
|------|--|
-

two pink dotted lines X1 and X2 are displayed in the horizontal direction of the screen.

- Click Y in the type menu to highlight it, and two pink dotted lines Y1 and Y2 are displayed in the horizontal direction of the screen.
- Click XY in the type menu and two pink dotted lines X1 and X2 in the vertical direction and two pink dotted lines Y1 and Y2 in the horizontal direction are displayed on the screen.

#### 5. Set Cursor Line

- Click Y1 or Y2 in the cursor line menu and turn General knob to move the cursor lines Y1 or Y2 up and down; select Y1&Y2 and turn General knob to move two cursor lines Y1 and Y2 up and down simultaneously.
  - Click X1 or X2 in the cursor line menu and turn General knob to move the cursor lines X1 or X2 left and right; select X1&X2 and turn General knob to move two cursor lines X1 and X2 left and right simultaneously.
- 

## Cursor Measurement in XY Mode

To perform a XY cursor measurement, perform the following steps:

---

- |      |  |
|------|--|
| Step | <ol style="list-style-type: none"><li>1. Click XY Mode shortcut at the top of screen can directly enable XY mode.</li><li>2. Press Cursor key to pop up the cursor measurement setting window. The cursor information display bar located to the right of the waveform display area displays the cursor readings.</li><li>3. In setting window, select Window as XY, can make the cursor line appear in the main</li></ol> |
|------|--|
-

waveform area or XY waveform area.

4. The XY in the type menu is highlighted and two dotted lines X1 and X2 in the vertical direction and two dotted lines Y1 and Y2 in the horizontal direction are displayed on the screen.
  5. Set Cursor Line
    - Click Y1 or Y2 in the cursor line menu and turn General knob to move the cursor lines Y1 or Y2 up and down; select Y1&Y2 and turn General knob to move two cursor lines Y1 and Y2 up and down simultaneously.
    - Click X1 or X2 in the cursor line menu and turn General knob to move the cursor lines X1 or X2 left and right; select X1&X2 and turn General knob to move two cursor lines X1 and X2 left and right simultaneously.
-

## How to realize waveform operation function

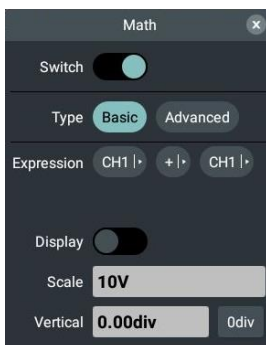

Waveform operation functions include addition, subtraction, multiplication, division, integration, differentiation, square root and custom function operations for Channel 1, Channel 2, Channel 3 and

Channel 4 waveforms. Click  in the right corner of the screen, then select Math to display setting window, as shown in the figure below.



The descriptions of Math setting window are shown in the table below:

Menu	Setting	Description
Switch		Open or close the waveform mathematics.
Type	Basic	Waveform calculation of simple addition, subtraction, multiplication and division for CH1, CH2, CH3 and CH4.
Expression	Advanced	Advanced waveform calculation for CH1, CH2, CH3 and CH4, such as integration, calculus, square roots or custom function operations.
Display	CH1   ▶	Select CH1, CH2, CH3 or CH4 signal source.
	+   ▶	Select operation sign.
	CH1   ▶	Select CH1, CH2, CH3 or CH4 signal source.



Scale		Open or close math operation formula.
Vertical		Turn General knob to adjust the vertical gear of Math waveform.
Type	0 div	Click Numeric Input Box to directly input the vertical position of the Math waveform to be set and click the unit to confirm; or click Gear Input Box (- or +) or turn General knob to set the vertical position of Math waveform to be set, click < > or press   to move the cursor and select the digit to be set. Click 0 div, the waveform vertical position can be zero.

## Waveform Calculation

Take Channel 1 + Channel 2 as an example, the operating steps are as follows:

### Step

1. Click  in the right corner of screen, then select Math, the screen will pop up math setting window.
2. Click Switch to highlight it, and the pink waveform M will display on the screen.
3. Click Basic to highlight it.
4. Click CH1 | ► to select CH1.
5. Click + | ► to select +.
6. Click CH1 | ► to select CH2.
7. Click Display. When the switch label is highlighted on the right, it is enabled. The pink Math and formula will be displayed at the lower left corner of the screen.
8. Click the Numeric Display Box of Scale and turn General knob to adjust the vertical scale of Math waveform.

- Click Vertical, click Numeric Input Box to directly input the vertical position of Math waveform to be set and click the unit to confirm; or click Gear Input Box (- or +) or turn General knob to set the vertical position of Math waveform to be set and click < > or press   to move the cursor and select the digit to be set.

## Custom Function Operation

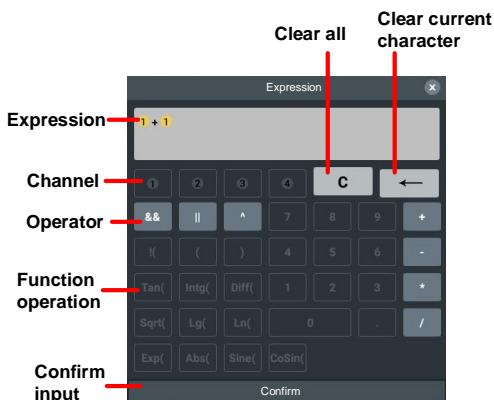

### Step

- Click  in the right corner of screen, then select Math, the screen will pop up math setting window.
- Click Switch to highlight it, and the pink waveform M will display on the screen.
- Click Advanced to highlight it.
- Click Expression Display Box to pop up expression input soft keyboard on the screen.



- Create the expression, then select Confirm in the keyboard to implement.
- Click Display. When the switch label is highlighted on the right, it is enabled. The

formula will be displayed at the lower left corner of the screen.

7. Click the Numeric Display Box of Scale and turn General knob to adjust the vertical scale of Math waveform.
  8. Click Vertical, click Numeric Input Box to directly input the vertical position of Math waveform to be set and click the unit to confirm; or click Gear Input Box (- or +) or turn General knob to set the vertical position of Math waveform to be set and click < > or press   to move the cursor and select the digit to be set.
-

## How to set FFT

FFT decomposes the signal into component frequencies, and the oscilloscope uses these component frequencies to display the graph of signal frequency domain, which corresponds to the standard time domain graph of the oscilloscope. Then match these frequencies with known system frequencies, such as the system clock, oscilloscope or power supply.

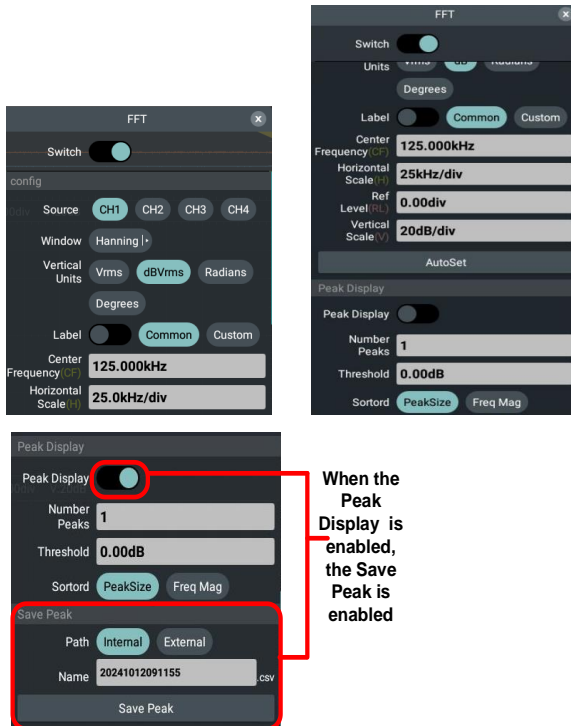

The FFT operation of this instrument can convert data points of the time domain waveform into frequency domain signal. The maximum number of analysis points for FFT calculation is 1 Mpts. The FFT setting window is shown as follows:



FFT operating steps are as follows:

---

Step

1. Click  in the right corner of screen, then select FFT, the screen will pop up FFT setting window.
  2. Click Switch when the switch label is highlighted on the right, it is enabled. The pink waveform M will be displayed on the screen (It is also available to click FFT shortcut softkey at the upper part of the screen).
  3. Click the signal source CH1.
  4. Click  and select the window type to be used from the displayed window.
  5. Click Vertical Units and select Vrms, dBVrms, Radians or Degrees.
  6. Click Label, when the switch label is highlighted on the right, it is enabled. You can choose common or custom label type.
  7. Click Center Frequency, Horizontal Scale, Ref Level, Vertical Scale Numeric Display Box respectively and set the value required. Or click AutoSet in the FFT display can observe suitable waveforms.
  8. Click Peak Display, when the switch label is highlighted on the right, it is enabled. A peak display list appears at the top left of the screen. The number of lists is determined by the number of peaks and the threshold. The peak display list is displayed at the top left of the waveform.
  9. Click Number Peaks Numeric Display Box, set the value required and setting range is 1 to 15.
  10. Click Threshold Numeric Display Box and set
-

the value required. The threshold range is related to the current FFT gear and offset.

11. Click Sortord and select the sortord type PeakSize or Freq Mag.
12. Click Path and select the save path is Internal or External.
13. Click Name Numeric Display Box and set the name required.
14. Click Save Peak to save the file.









Note

12-14 valid only when peak display is on.

### The Description of FFT Window

There are 6 FFT windows. Each one has trade-offs between frequency resolution and amplitude accuracy. What you want to measure and your source signal characteristics help you to determine which window to use. Use the following guidelines to select the best window.

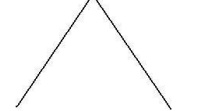
Type	Descriptions	Window
Rectangle	<p>Best solution for frequency, worst for magnitude.</p> <p>Best type for measuring the frequency spectrum of nonrepetitive signals and measuring frequency components near DC.</p> <p>Recommend to use for:</p> <ul style="list-style-type: none"> <li>• Transients or bursts, the signal level before and after the event are nearly equal.</li> <li>• Equal-amplitude sine waves with frequencies those are very close.</li> <li>• Broadband random noise with a relatively slow varying spectrum.</li> </ul>	

<p>Hanning</p>	<p>Good for magnitude, but poorer frequency resolution than Hamming.</p> <p>Recommend to use for:</p> <ul style="list-style-type: none"> <li>• Sine, periodic and narrow band random noise.</li> <li>• Transients or bursts where the signal levels before and after the event are significantly different.</li> </ul>	
<p>Hamming</p>	<p>Better solution for magnitude than Rectangle, and good for frequency as well. It has slightly better frequency resolution than Hanning.</p> <p>Recommend to use for:</p> <ul style="list-style-type: none"> <li>• Sine, periodic and narrow band random noise.</li> <li>• Transients or bursts where the signal levels before and after the event are significantly different.</li> </ul>	
<p>Blackman</p>	<p>Best solution for magnitude, worst for frequency.</p> <p>Recommend to use for:</p> <ul style="list-style-type: none"> <li>• Single frequency waveforms, to find higher order harmonics.</li> </ul>	
<p>Bartlett</p>	<p>The Bartlett window is a slightly narrower variant of the triangular window, with zero weight at both ends.</p>	
<p>Kaiser</p>	<p>The frequency resolution when using the Kaiser window is fair; the spectral leakage and amplitude accuracy are both good.</p> <p>The Kaiser window is best used when frequencies are very close to the same value but have widely</p>	

	<p>differing amplitudes (the side lobe level and shape factor are closest to the traditional Gaussian RBW). This window is also good for random signals.</p>	
--	--	--

Notes for using FFT

- Use the default dBVrms scale for details of multiple frequencies, even if they have very different amplitudes. Use the dBVrms scale to compare frequencies.
- DC component or offset can cause incorrect magnitude values of FFT waveform. To minimize the DC component, choose AC Coupling on the source signal.
- To reduce random noise and aliased components in repetitive or single-shot events, set the oscilloscope acquisition mode to average.

What is Nyquist frequency



The Nyquist frequency is the highest frequency that any real-time digitizing oscilloscope can acquire without aliasing. This frequency is half of the sample rate. Frequencies above the Nyquist frequency will be under sampled, which causes aliasing. So pay more attention to the relation between the frequency being sampled and measured.

## How to set magnifier

Click on the main menu window  to select Magnifier menu, the menu is shown in the figure below:



The descriptions of setting menu are shown in the table below:

Menu	Setting	Description
Switch		Turn on/off the magnifier function.
Vertical Ratio		Vertical multiplier can be clicked  , in the right display box select vertical multiplier.
Window Position	Vertical Horizontal	Click Numeric Input Box to directly input the vertical/horizontal position of waveform to be set and click the unit to confirm; or click Gear Input Box (- or +) or turn General knob to set the vertical/horizontal position of waveform to be set, click < > or press   to move the cursor and select the digit to be set.

The following picture is shown after the magnifying glass function is turned on:

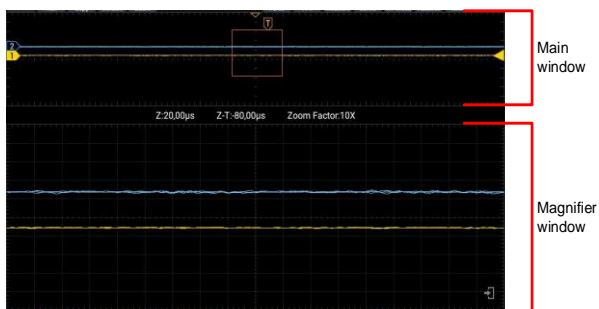

In the main window can be selected to enlarge the interval, the magnification window shows the magnifying glass magnified waveform.

## How to set Filters (Digital Filtering)

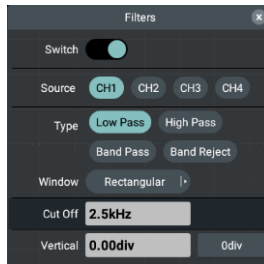

Digital filtering supports low pass, high pass, band pass and band reject types, and the specific frequency in the signal can be filtered out by setting the cut-off frequency. The setting window is shown as below.



To perform digital filtering setting, follow the steps below.

- Step
1. Click Filters in the analysis module from the main menu window  at the lower right of the screen.
  2. In the setting window, click Switch when the switch label is highlighted on the right, it is enabled. The pink waveform M will be displayed on the screen.
  3. Select CH1, CH2, CH3 or CH4 in the Source option.
  4. Select the filter required in the Type option.
  5. Select the appropriate window in the Window option.
  6. Click Cut Off frequency numeric window:  
When Low Pass or High Pass is selected as the filter type, it is available to set the required cut-off frequency in the lower part of the menu.  
When Band Pass or Band Reject is selected as the filter type, it is available to set the required Up frequency limit or Down frequency limit in

the lower part of the menu.

7. Click Vertical in the option, directly click Numeric Input Box to input the vertical position of the Math Waveform to be set and click the unit or OK to confirm; or click Gear Input Box (- or +) or turn General knob to set the vertical position of the Math Waveform to be set, click < > or press   to move the cursor and select the digit to be set. The voltage gear of the Math Waveform is the same as that of the current channel.
- 



Note

In slow sweep, the digital filter function is disabled.

---

## How to set FRA (Frequency Response Analysis) (for GDS-2000HG Series only)

The Frequency Response Analysis (FRA) function controls the built-in signal generator to scan the sine waves across the frequency range and simultaneously measure the input and output of the device under test. The gains and phases are measured at each frequency and plotted on the frequency response Bode Plot. After the frequency response analysis is completed, you can move the marker on the graph to see the gain and phase values measured at various frequency points. You can also adjust the scale and offset settings of gain and phase graphs.





Note

If the signal is interfered seriously, it is recommended to set the average value acquisition as the collection mode before operating the frequency response analysis. The average frequency can only be selected to 4 or 16, and then the frequency response analysis can be performed.

Click FRA in the analysis module from the main menu window  at the lower right of the screen.

he descriptions of the menu are shown below:

Menu	Description
Switch	Enable FRA function. When it is enabled, the FRA scale and Bode Plot are displayed on the screen.
Start Analysis	Operate the frequency response analysis. Information displayed during the frequency sweep process: Frequency, Gain and Phase.
Points/ Decade	Points displayed every 10x frequency, ranging from 10 to 100 with the default value of 10.
Start Freq	Set the start value of sweep frequency, ranging from 10 Hz to 25 MHz with the default value of 10 Hz.
End Freq	Set the stop value of sweep frequency, ranging from 10 Hz to 25 MHz with the default value of 25 MHz.

	 Note The value of “End Frequency” shall be set larger than that of “Start Frequency”.
Amplitude	Set the voltage amplitudes for different frequency ranges.  Note The amplitude ranges from 2 mV to 6 V.
Move Marker	Move the sign to view the measured gain and phase values.
Gain Scale	Adjust the gain scale value of the amplitude-frequency curve, ranging from 5.0 dB/div to 50.0 dB/div.
Gain Offset	Adjust the offset position of the amplitude-frequency curve, ranging from -250.0 dB to 250.0 dB.
Phase Scale	Adjust the phase scale value of the phase-frequency curve, ranging from 5.0 °/div to 90.0 °/div.
Phase Offset	Adjust the offset position of the phase-frequency curve, ranging from -180.0° to 180.0°.
Auto Scale	Automatically set the gain scale and phase scale to the appropriate values based on the amplitude-frequency curve generated, so that the waveform is occupying the largest plot area and easy to be observed.
Connection Diagram	Before using FRA function, it is required to make proper loop connection. Click Wiring Diagram to view the circuit wiring diagram with FRA function in the pop-up window; click any location outside the pop-up window to close the wiring diagram window.
CSV Export	Path      Internal: Save the file to internal storage. External: Save the file to External storage.  Name      You can manually edit the file name or save using the system default. Files are exported in .csv format.

To run the frequency response analysis, operate according to the following steps:

- Step
1. Connect the output end of the built-in signal generator to the device under test and connect input channel CH1 and CH2 of the oscilloscope to the input and output end of the device respectively.
  2. Click FRA in the analysis module from the main menu window  at the lower right of the screen.
  3. Click Switch in the FRA setting window displayed on the screen; when the switch label is highlighted on the right, it is enabled.
  4. Click the menu in the FRA setting window and set related parameters.
  5. Click “Start Analysis” in the FRA setting window to run the frequency response analysis.

Under FRA Analysis



Click to stop FRA analysis

End of FRA Analysis



Turn the knob to move the symbol

## How to set pass fail

Click Pass Fail in the analysis module from the main menu window  at the lower right of the screen. The descriptions of the setting window are shown in the table below:

Menu	Setting	Description
Switch		Open or close Pass/ Fail measure function.
Operate		Control operate switch.
Configuration	Source	CH1 CH2 Select CH1, CH2, CH3 or CH4 CH3 source. CH4
	Category	PASS Select pass or fail set type. Pass: The measured signal conforms to the set rules. FAIL Fail: The measured signal doesn't conform to the set rules.
	Stop	Open or close Stop function. When enabled, it stops as soon as the set rules are met.
	Beep	Open or close Beep function. When enabled, the beep rings when the setting is met.
	Message Display	Open or close pass/fail message display navigate window.
	TheMaskRule Mask	Horizontally Disposed
Vertically Disposed		0.04 div to 2 div, click Numeric Input Box, set the vertical value required.
CreateRule		Click to set the conditions as the test rules.

Mask save & read	0 Null ... 7 Null	According to require test rule, can set 8 groups test rules.  Note Null: Indicates empty, no rule is created; Rule: Indicates that a rule has been created.
	Save	Click and save the set test rules.
	Rename	According to requirement to rename the rule.
	Read	Click to print the saved test rule.

### Pass/Fail

It detects whether the input signal of the channel is within the rules. If it is out of range, it is a failure; otherwise, it is a pass. It can output failure or pass signal through the built-in, configurable output port.

To perform a Pass/Fail test, follow these steps:

To perform counter, follow these steps:

- 
- |      |   |
|------|---|
| Step | <ol style="list-style-type: none"> <li>1. Click Pass Fail in the analysis module in the main setting window at the bottom right of the screen  .</li> <li>2. In the setting window, click Switch when the switch label is highlighted on the right, it is enabled.</li> <li>3. Configuration: In the configuration menu, set output type is PASS or FAIL; set output mode whether to open Stop or Beep; set whether to open Message Display.</li> <li>4. TheMaskRule: In TheMaskRule menu select Source, in Horizontally Disposed or Vertically Disposed, click Numeric Input Box, set horizontal value or vertical value; click to CreateRule.</li> </ol> |
|------|---|
-

5. Operate: Click Operate, when the switch label is highlighted on the right, it is enabled.
  6. Mask save & Read: Select Save in the bottom of the screen, you can call the Read immediately when you need it later.
- 



- In the case of Pass/Fail on, open XY, FFT or Zoom mode, Pass/Fail will close; In XY, FFT or Zoom mode, Pass/Fail function menu is gray, it can not to use.
  - In the case of factory setting on, Pass/Fail will close.
  - During the detection process, the signal source cannot be modified, and the output stop, ring, create rule, save, and read operations cannot be performed. Only the information display and switch operations can be performed.
  - In stop state, don't compare data. While continuing to run, pass fail total will add it, doesn't start at 0.
-

## How to set counter

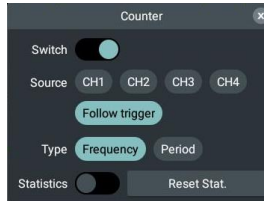



To perform counter, follow these steps:

- Step
1. Click Counter in the analysis module in the main setting window at the bottom right of the screen . The setting window will display on the screen.
  2. In the setting window, click Switch when the switch label is highlighted on the right, it is enabled, counter menu will display in the right list. And click Switch again or draw the information bar to the right, can close the function.
  3. Select CH1, CH2, CH3, CH4 or Follow trigger in the Source option.
  4. Select Frequency or Period in the Type option.
  5. Click Statistics when the switch label is highlighted on the right, it is enabled, counter will display Type, Max, Min and Avg; If off, only the Type is displayed.



Note

Click  /  on the top right corner of the counter information display bar can directly enable or disable the statistics function.

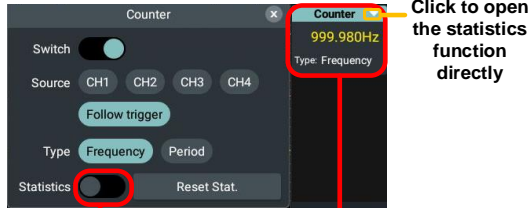

The statistics function is not turned on, and the Counter only displays the measurement type

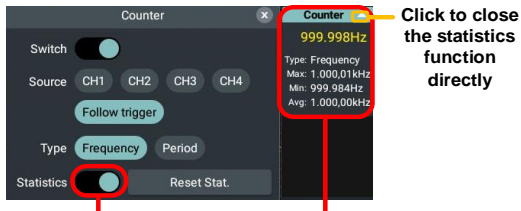

The statistical function is turned on, and the Counter displays the measurement type, maximum value, minimum value and average value

6. Click Reset Stat., the historical data of the counter will be cleared and the statistics will be re-conducted.

## How to set DVM

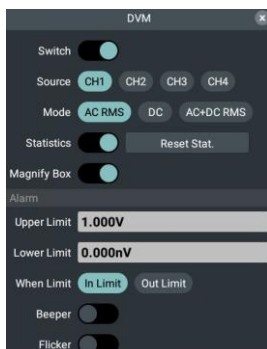



To perform DVM, follow these steps:

- Step
1. Click DVM in the analysis module in the main setting window at the bottom right of the screen . The setting window will display on the screen.
  2. In the setting window, click Switch when the switch label is highlighted on the right, it is enabled, DVM information display bar will display in the right list. And click Switch again or draw the information bar to the right, can close the function.
  3. Select CH1, CH2, CH3 or CH4 in the Source option.
  4. Select AC RMS, DC or AC+DC RMS in the Mode option.
  5. Click Statistics when the switch label is highlighted on the right, it is enabled, DVM will display Type, Max, Min and Avg; if off, only the Type is displayed.



Note

Click  /  on the top right corner of the DVM information display bar can directly enable or disable the statistics function.

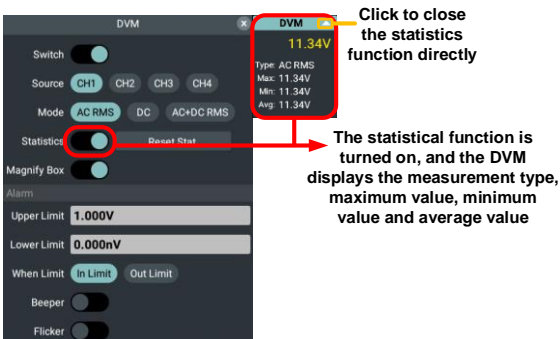
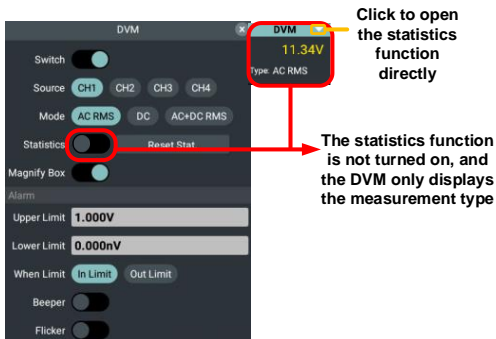

6. Click Reset Stat., the historical data of the counter will be cleared and the statistics will be re-conducted.
7. Click Magnify box when the switch label is highlighted on the right, it is enabled. The zoom box will appear at the top right of the screen, and the number will match the number in the list on the right.



8. Alarm: In the Upper Limit or Lower Limit option, click Numeric Input Box to set the upper or lower limit value. In When Limit to set the limit condition to In Limit or Out Limit. Set the switch whether to turn on the Beeper.
  9. Flicker: In the Upper Limit or Lower Limit option, click Numeric Input Box to set the upper or lower limit value. In When Limit to set the limit condition to In Limit or Out Limit. Set the switch whether to turn on the Flicker. The DVM information display panel on the right-side list will enter a **blinking state** if the measured values meet the predefined conditions.
-

## How to set decode

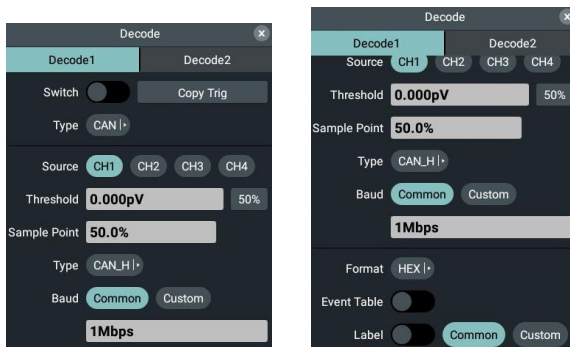

To perform Decode, follow these steps:

- Step 1. Click Decode in the analysis module in the main setting window at the bottom right of the screen .
2. The setting window will display on the screen. Click Decode1 or Decode2 to set decode. Click Switch, when the switch label is highlighted on the right, it is enabled. Click Copy Trig, the settings for the trigger type can be copied.
3. Select RS232/UART, I<sup>2</sup>C, SPI, CAN or LIN in Type option.
4. Select HEX, DECIMAL, BINARY or ASCII in Format option.
5. Click Event Table, when the switch label is highlighted on the right, it is enabled. A list of decoders is displayed on the left side of the screen.

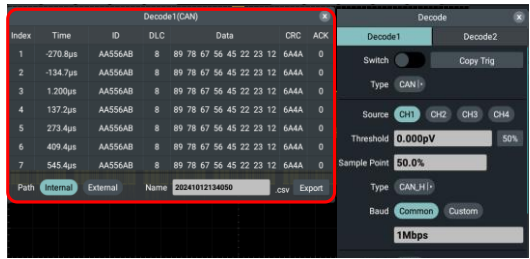

- In the Path option, select the storage path as Internal or External; click Name Input Box can edit the filename or save the waveform with the system default filename, the file format is csv; click Export, can save the file.
6. Click Label, when the switch label is highlighted on the right, it is enabled. You can select Common or Custom as the label type.

## RS232/UART Decode

To perform decode RS232/UART signal, follow these steps:



- Step
1. Connect the RS232/UART signal to the Signal Input Channel of the oscilloscope.
  2. Adjust to the proper time base and voltage division.
  3. In trigger menu, select trigger type as RS232/UART, set parameters based on the characteristics of the signal, trigger the signal correctly and obtain stable display. Refer to “RS232/UART Trigger” on page 74.
  4. After the signal is stabilized and triggered, click Decode in the analysis module in the main setting window at the bottom right of the screen . Select the type as RS232/UART, set parameters based on the characteristics of the signal. When the parameters are set correctly, the information carried by the signal will be displayed.





Note

When decoding, if “Parity” is not set to “None”, and the check bit error is detected, P marks will be displayed in the corresponding position in the waveform.

The descriptions of RS232/UART decode setting window are as shown in the table below:

Menu	Setting	Description
Switch	Copy Trig	Click Switch, when the switch label is highlighted on the right, it is enabled. When the trigger type is bus trigger (RS232/UART, I <sup>2</sup> C, SPI, CAN, or LIN), clicking the <b>Copy Trig</b> button allows you to copy the current trigger settings.
Type	RS232/ UART	Set the decode type as RS232/UART.
Source	CH1 CH2 CH3 CH4	Select CH1, CH2, CH3 or CH4 as the decode signal source.
Threshold	50 %	Click Numeric Display Box and turn General knob to set the lower threshold; Click 50 % and set the shortcut key of trigger level in the vertical midpoint of the trigger signal amplitude.
Polarity		Select positive polarity for data transmission.
		Select reverse polarity for data transmission.
Baud	Common	Click Numeric Display Box and turn General knob to set the commonly-used baud rate.
	Custom	Click Numeric Display Box to input the baud rate to be set and click unit to confirm; or click Gear Input Box (- or

		+) or turn the General knob to set the baud rate, and click < > or press   to move the cursor and select the digit to be set. The baud rate ranges from 50 to 10,000,000.
 Note		You can select the nearest value in Common Baud, and then adjust it in this menu.
Data Bits	5, 6, 7, 8	Set the data width of each frame to match the signal. It can be set to 5, 6, 7 or 8.
Parity	None, Odd, Even	Set the even-odd check mode to match the polarity used by the signal.
Stop Bit	1, 1.5, 2	Select 1, 1.5 or 2 as the end of decoding sign.
Endian	LSB MSB	LSB: Least Significant Bit, that is, the data is transmitted low first. MSB: Most Significant Bit, that is, the data is transmitted high first.
Format	HEX DECIMAL BINARY ASCII	Select the display format to decode.
Event Table		Click Switch, when the switch label is highlighted on the right, it is enabled. The decode list will display on the screen.
Label	Common Custom	Click Label, when the switch label is highlighted on the right, it is enabled. You can select Common or Custom as the label type.

## I<sup>2</sup>C Decode

To perform decode I<sup>2</sup>C signal, follow these steps:

- 
- Step                      1. Connect the clock line (SCLK) and the data line (SDA) of the I<sup>2</sup>C signal to the Signal Input Channels of the oscilloscope.

2. Adjust to the proper time base and voltage division.
3. In trigger menu, select trigger type as I<sup>2</sup>C, set parameters based on the characteristics of the signal, trigger the signal correctly and obtain stable display. Refer to “I<sup>2</sup>C Trigger” on page 77.
4. After the signal is stabilized and triggered, click Decode in the analysis module in the main setting window at the bottom right of the screen . Select the type as I<sup>2</sup>C, set parameters based on the characteristics of the signal. When the parameters are set correctly, the information carried by the signal will be displayed.

Decoded information interpretation

Information	Abbreviation
Read Address	R
Write Address	W

The descriptions of I<sup>2</sup>C decode setting window are as shown in the table below:

Menu	Setting	Description
Switch	Copy Trig	Click Switch, when the switch label is highlighted on the right, it is enabled. When the trigger type is bus trigger (RS232/UART, I <sup>2</sup> C, SPI, CAN, or LIN), clicking the <b>Copy Trig</b> button allows you to copy the current trigger settings.
Type	I <sup>2</sup> C	Set the decode type as I <sup>2</sup> C.
SCL	CH1 CH2 CH3 CH4	Select CH1, CH2, CH3 or CH4 as SCL.

Threshold	50 %	Click Numeric Display Box and turn General knob to set the lower threshold; Click 50 % and set the shortcut key of trigger level in the vertical midpoint of the trigger signal amplitude.
SDA	CH1 CH2 CH3 CH4	Select CH1, CH2, CH3 or CH4 as SDA.
Threshold	50 %	Click Numeric Display Box and turn General knob to set the lower threshold; Click 50 % and set the shortcut key of trigger level in the vertical midpoint of the trigger signal amplitude.
Source	Exchange	Click Exchange, the sources of SCL and SDA can be exchanged.
R/W	With Without	When read and write bits are not included, they are added automatically depending on the function.
Format	HEX DECIMAL BINARY ASCII	Select the display format to decode.
Event Table		Click Switch, when the switch label is highlighted on the right, it is enabled. The decode list will display on the screen.
Label	Common Custom	Click Label, when the switch label is highlighted on the right, it is enabled. You can select Common or Custom as the label type.

## SPI Decode





To perform decode SPI signal, follow these steps:

- |      |  |
|------|--|
| Step | <ol style="list-style-type: none"> <li>1. Connect the clock line (CLK) and the data line (MISO/MOSI) of the SPI signal to the Signal Input Channels of the oscilloscope.</li> <li>2. Adjust to the proper time base and voltage division.</li> <li>3. In trigger menu, select trigger type as SPI, set parameters based on the characteristics of the signal, trigger the signal correctly and obtain stable display. Refer to "SPI Trigger" on page 80.</li> <li>4. After the signal is stabilized and triggered, click Decode in the analysis module in the main setting window at the bottom right of the screen . Select the type as SPI, set parameters based on the characteristics of the signal. When the parameters are set correctly, the information carried by the signal will be displayed.</li> </ol> |
|------|--|

The descriptions of SPI decode setting window are as shown in the table below:

Function	Menu Setting	Description
Switch	Copy Trig	Click Switch, when the switch label is highlighted on the right, it is enabled. When the trigger type is bus trigger (RS232/UART, I <sup>2</sup> C, SPI, CAN, or LIN), clicking the <b>Copy Trig</b> button allows you to copy the current trigger settings.
Type	SPI	Set the decode type as SPI.

Mode	Time out	CLK	Select CH1,CH2,CH3 or CH4 as CLK.
		Threshold	Click Numeric Display Box and turn General knob to set the lower threshold; Click 50 % and set the shortcut key of trigger level in the vertical midpoint of the trigger signal amplitude.
		MISO/MOSI	Select CH1, CH2, CH3 or CH4 as MISO/MOSI.
	Timeout	Threshold	Click Numeric Display Box and turn General knob to set the lower threshold; Click 50% and set the shortcut key of trigger level in the vertical midpoint of the trigger signal amplitude.
		Timeout	Click Numeric Display Box and turn General knob to set the required timeout.
		CLK	Select CH1,CH2,CH3 or CH4 as CLK.
	CS	50 %	Click Numeric Display Box and turn General knob to set the lower threshold; Click 50 % and set the shortcut key of trigger level in the vertical midpoint of the trigger signal amplitude.
		MISO	Select CH1, CH2, CH3 or CH4 as MISO.
		Threshold	Click Numeric Display Box and turn General knob to set the lower threshold; Click 50 % and set the shortcut key of trigger level in the vertical midpoint of the trigger signal amplitude.

	MOSI	Select CH1, CH2, CH3 or CH4 as MOSI; or select OFF to close MOSI.
	Threshold	Click Numeric Display Box and turn General knob to set the lower threshold; Click 50 % and set the shortcut key of trigger level in the vertical midpoint of the trigger signal amplitude.
		CS
	Threshold	Click Numeric Display Box and turn General knob to set the lower threshold; Click 50 % and set the shortcut key of trigger level in the vertical midpoint of the trigger signal amplitude.
Polarity		Select positive polarity for data transmission.
		Select reverse polarity for data transmission.
Clock Edge		Set the clock edge to rising edge or falling edge. The rising edge refers to acquire the data at the rising edge of the clock.
		The falling edge refers to acquire the data at the falling edge of the clock.
Data Bits		Click Numeric Display Box and turn General knob to set the data bit width.
Endian	LSB	LSB: Least Significant Bit, that is, the data is transmitted low first.
	MSB	MSB: Most Significant Bit, that is, the data is transmitted high first.

Format	HEX DECIMAL BINARY ASCII	Select the display format to decode.
Event Table		Click Switch, when the switch label is highlighted on the right, it is enabled. The decode list will display on the screen.
Label	Common Custom	Click Label, when the switch label is highlighted on the right, it is enabled. You can select Common or Custom as the label type.

## CAN Decode

To perform decode CAN signal, follow these steps:



- |      |   |
|------|---|
| Step | <ol style="list-style-type: none"> <li>1. Connect the CAN signal to the Signal Input Channel of the oscilloscope.</li> <li>2. Adjust to the proper time base and voltage division.</li> <li>3. In trigger menu, select trigger type as CAN, set parameters based on the characteristics of the signal, trigger the signal correctly and obtain stable display. Refer to “CAN Trigger” on page 83.</li> <li>4. After the signal is stabilized and triggered, click Decode in the analysis module in the main setting window at the bottom right of the screen . Select the type as CAN, set parameters based on the characteristics of the signal. When the parameters are set correctly, the information carried by the signal will be displayed.</li> </ol> |
|------|---|



Note

Error Frame, Remote Frame, and Overload Frame will be identified in the “Data” column in the event table (Data Frame will not be identified).

The descriptions of CAN decode setting window are as shown in the table below:

Menu	Setting	Description
Switch	Copy Trig	Click Switch, when the switch label is highlighted on the right, it is enabled. When the trigger type is bus trigger (RS232/UART, I <sup>2</sup> C, SPI, CAN, or LIN), clicking the <b>Copy Trig</b> button allows you to copy the current trigger settings.
Type	CAN	Set the decode type as CAN.
SCL	CH1 CH2 CH3 CH4	Select CH1, CH2, CH3 or CH4 as the decode signal source.
Threshold	50 %	Click Numeric Display Box and turn General knob to set the lower threshold; Click 50 % and set the shortcut key of trigger level in the vertical midpoint of the trigger signal amplitude.
Sample Point		Click Numeric Display Box and turn General knob to set the sample point.
Type		Select CAN_H, CAN_L, RX, TX or DIFF as the frame type.
Baud	Common	Click Numeric Display Box and turn General knob to set the commonly-used baud rate.
	Custom	Click Numeric Display Box to input the baud rate to be set and click unit to confirm; or click Gear Input Box (- or +) or turn the General knob to set the baud rate, and click < > or press   to move the cursor and select the digit to be set. The baud rate ranges from 10 kbps to 1 Mbps.
 Note	You can select the nearest value in Common Baud, and then adjust it in this menu.	



Format	HEX DECIMAL BINARY ASCII	Select the display format to decode.
Event Table		Click Switch, when the switch label is highlighted on the right, it is enabled. The decode list will display on the screen.
Label	Common Custom	Click Label, when the switch label is highlighted on the right, it is enabled. You can select Common or Custom as the label type.

## LIN Decode

To perform decode LIN signal, follow these steps:

- |      |   |
|------|---|
| Step | <ol style="list-style-type: none"> <li>1. Connect the LIN signal to the Signal Input Channel of the oscilloscope.</li> <li>2. Adjust to the proper time base and voltage division.</li> <li>3. In trigger menu, select trigger type as LIN, set parameters based on the characteristics of the signal, trigger the signal correctly and obtain stable display. Refer to "LIN Trigger" on page 86.</li> <li>4. After the signal is stabilized and triggered, click Decode in the analysis module in the main setting window at the bottom right of the screen . Select the type as LIN, set parameters based on the characteristics of the signal. When the parameters are set correctly, the information carried by the signal will be displayed.</li> </ol> |
|------|---|

The descriptions of LIN decode setting window are as shown in the table below:

Menu	Setting	Description
Switch	Copy Trig	Click Switch, when the switch label is highlighted on the right, it is enabled. When the trigger type is bus trigger (RS232/UART, I <sup>2</sup> C, SPI, CAN, or LIN), clicking the <b>Copy Trig</b> button allows you to copy the current trigger settings.
Type	LIN	Set the decode type as LIN.
SCL	CH1 CH2 CH3 CH4	Select CH1, CH2, CH3 or CH4 as the decode signal source.
Threshold	50 %	Click Numeric Display Box and turn General knob to set the lower threshold; Click 50 % and set the shortcut key of trigger level in the vertical midpoint of the trigger signal amplitude.
Baud	Common	Click Numeric Display Box and turn General knob to set the commonly-used baud rate.
	Custom	Click Numeric Display Box to input the baud rate to be set and click unit to confirm; or click Gear Input Box (- or +) or turn the General knob to set the baud rate, and click < > or press   to move the cursor and select the digit to be set. The baud rate ranges from 50 bps to 20 kbps.
 Note	You can select the nearest value in Common Baud, and then adjust it in this menu.	
Parity Bit	With Without	In the checkpoint* tab, click on the With or Without checkpoints in the configuration DATA.
Version	1.X 2.X Both	In the version TAB, click to select the protocol version that matches the LIN bus signal as "1.X", "2.X" or "Both".

Format	HEX DECIMAL BINARY ASCII	Select the display format to decode.
Event Table		Click Switch, when the switch label is highlighted on the right, it is enabled. The decode list will display on the screen.
Label	Common Custom	Click Label, when the switch label is highlighted on the right, it is enabled. You can select Common or Custom as the label type.

### How to set waveform record/player

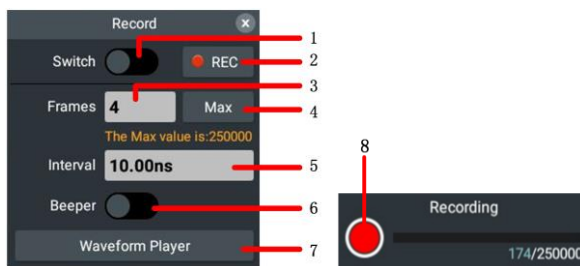

The descriptions of waveform reorder setting window are as shown in the table below:



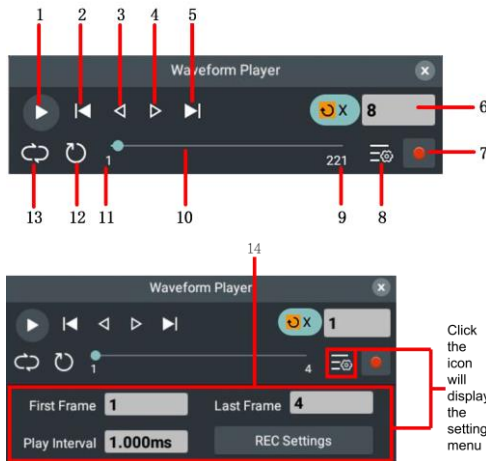

Number	Description
1	Enable waveform record function.
2	Once all parameters are set, click REC to start recording the waveform.
3	The number of recorded frames refers to the actual number of frames that can be recorded. After starting the recording, when the recorded frames reach the set number, the oscilloscope will automatically stop the recording. Click the Numeric Display Box and adjust the General knob or the numeric keypad to set the number of frames. The adjustable range is from 2 to the maximum number of frames that can be recorded. The adjustment range is related to the recording collection length.

	Record Depth	Range
	1 k	2-250000
	10 k	2-32500
	100 k	2-4000
	1 M	2-500
	10 M	2-30
	100 M	2-4
4	Click <b>Max</b> the number of recorded frames will be automatically set to the maximum number of frames.	
5	Set the time interval between frames during the recording process. The range is from 10 ns to 1 s.	
6	When the switch is highlighted on the right, it means the function is enabled. At the end of the recording, the buzzer will emit a sound.	
7	Click this button to open the waveform playback window.	
8	During waveform recording, clicking will end the recording prematurely.	





The descriptions of waveform player setting window are as shown in the table below:

Number	Description
1	Play button, click it to start or pause the waveform replay.
2	Return to First Frame.

3	Play the previous frame.
4	Play the next frame.
5	Return to Last Frame.
6	Set the current frame. Click the Numeric Display Box and adjust the General knob or the numeric keypad to set the current frame.
7	Restart recording with the current parameters.
8	Click it can display the setting menu.
9	Last frame.
10	Progress bar, drag it to change the current frame.
11	First frame.
12	<p>Click to switch the waveform player direction.</p> <p>: Sequential playback, from the first frame to the last frame.</p> <p>: Reverse playback, from the last frame to the first frame.</p>
13	<p>Click to switch the playback mode.</p> <p>: Loop playback: Repeats the playback from the first frame to the last frame until manually stopped.</p> <p>: Single playback: Plays from the current frame to the first/last frame and stops automatically afterward.</p>
14	<p>Set the waveform player information.</p> <p>First Frame: Click the Numeric Display Box and adjust the General knob or the numeric keypad to set the first frame of waveform player. The maximum value can be set to the number of frames that have been recorded.</p> <p>Last Frame: Click the Numeric Display Box and adjust the General knob or the numeric keypad to set the last frame of waveform player. The default value is the number of frames of the recorded waveform.</p> <p>Player Interval: Click the Numeric Display Box and adjust the General knob or the numeric keypad to set the player interval. Range is from 10 ns to 1 s.</p> <p>REC Settings: Click to reset the waveform recording parameters.</p>

## How to set display system

Click Display in the others module in the main setting window at the bottom right of the screen . The descriptions of Display setting window are as shown in the table below:

Menu	Setting	Description
Type	Point	Only display the acquisition points.
	Vector	Vector filling displays the space between adjacent acquisition points in the middle.
Persist	Close 1 Second 2 Seconds 5 Seconds Infinity	Select the time of duration.  Note: Currently support CH1, CH2, CH3, CH4, FFT, XY, Filters, waveform operation models.
	Clear	Erase previously collected results from the display. The oscilloscope will start cumulative collection again.
Wave Intensity		Slide adjusts the current wave intensity. Drag the slider to the right of Wave Intensity item to set waveform brightness. The adjustable range is 10 % to 100 %.
Color Grade		Open or close Color Grade function.
Low refresh rate		Open or close Low refresh rate. You can observe the waveform changing at a low refresh rate.
Show Scale		Enable or disable Show Scale. When enabled, the voltage scale is displayed on the right side of the grid, and the timebase scale is displayed at the bottom.
Grid		Select the current screen grid type.
	FULL	Indicates that the number of display grids on the screen is full. Open background grid, indicates that the number of display grids on the screen is full. Open background grid.

	GRID	Point grid, representing the display grid on the screen in addition to the grid where the scale line is located, every two adjacent scale lines between two small horizontal lines formed a line of points and lines.
	HALF	Semi-grid, indicating that the display grid on the screen closes part of the background grid, leaving only the main grid.
	NONE	No grid indicates that all background grids are closed on the screen.
Grid Brightness		Slide adjusts the current grid brightness. Drag the slider to the right of Grid Brightness item to set grid brightness. The adjustable range is 0 % to 100 %.
Window Transparency		Slide adjusts the current window brightness. Drag the slider to the right of Window Transparency item to set window brightness. The adjustable range is 0 % to 100 %.

### Afterglow

When afterglow function is used, the afterglow display of image tube can be simulated. The color of the original data retained is gradually lightened and that of new data becomes brighter.

1. Click Display in the others module in the main setting window at the bottom right of the screen .
2. Click Type to set it as Point or Vector.
3. Select the duration in the duration display box of the Persist, including Close, 1 Second, 2 Seconds, 5 Seconds and Infinity. When the duration is Infinity, the recording point is maintained until the control value is changed. Select Close to close the afterglow and clear the display.
4. Select Clear in the menu to erase previously

---

collected results from the display, and the oscilloscope will start cumulative collection again.

---

### Color Grade

The color temperature display function uses the color level to indicate the frequency of waveform occurrence. Warmer colors such as red/yellow indicate more frequent waveforms, while cooler colors such as blue/green indicate less frequent waveforms.



1. Click Display in the others module in the main setting window at the bottom right of the screen .
  2. Click Color Grade when the switch label is highlighted on the right, it is enabled, click again to close the Color Grade.
- 

### Show Scale

When using the Show Scale function, measurements are performed via adjustable reference lines. By adjusting the scale positions, you can directly read the waveform values on the scales.

1. Click the Main Menu window at the bottom right of the screen and select Display under "Other Modules."
2. Click Show Scale. When the toggle switch is highlighted on the right, it is ON; the voltage scale will be displayed on the right of the grid, and the timebase scale will be displayed at the bottom. Click the switch again to turn off the scale.

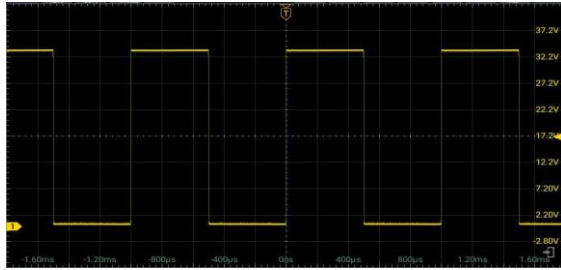

## How to save

User Configuration: Under normal circumstances, if there is no operation for 10 seconds, the configuration will be automatically saved, and the saved state will be restored when the app is opened again.

Click Save in the others module in the main setting window at the bottom right of the screen . Save oscilloscope waveform and picture, set to USB or internal memory by operating Save in the setting window.

The descriptions of save setting window are as shown in the table below:

Menu	Setting	Description	
Save	Type	Wave Image Set Select the function menu required.	
	When the type is Wave, the menu shows as following:		
	Path	Internal External Select the save path.Save in internal or external USB storage.	
	Format	Csv Zip Matlab Select the waveform save format.	
	Source	CH1 CH2 CH3 CH4 MATH Filters FFT Select the waveform to be saved. It is available to save CH1, CH2, CH3, CH4, MATH, Filters, or FFT waveforms (When a channel is not open, it can not be saved).	
	Name	Save the wave by editing the file name or the system default file name.	
	Suffix	Time Series None Add time suffix to file name. Add sequence number suffix to file name. No suffix for file name.	

Save		Save current waveform.
When the type is Image, the menu shows as following:		
Path	Internal External	Select the save path.Save in internal or external USB storage.
Browse		Click to open the browse screen to save the picture.
Format	Bmp Png Jpg Tif	Select the save format of current screen picture.
Inverse		Enable or disable picture save background; when the color inverse is enabled, use the white background to save the picture.
Time		Open or close the time for printing images. When enabled, the printed image will display the specific printing time of the image in the lower right corner of the image.
Name		Save the image by editing the file name or the system default file name.
Suffix	Time	Add time suffix to file name.
	Series	Add sequence number suffix to file name.
	None	No suffix for file name.
Save		Save current waveform.
When the type is Set, the menu shows as following:		
Path	Internal External	Select the save path.Save in internal or external USB storage.
Browse		Click to open saved settings.
Internal	User0. ... User9	Set storage location.
	Save	Save the current parameter settings of the oscilloscope to the internal memory.
	Load	Calls the settings saved at the current

			storage location.
		Rename	Rename the currently saved parameter. Click on the Rename Input Box and enter the string directly through the alphabet keyboard that pops up.
	External	Name	Save the settings by editing the file name or the system default file name.
		Import Set	Import saved configuration sets.
		Save	Save the current parameter settings of the oscilloscope to the external memory.

### USB Flash Drive Requirements

System-supported USB flash drive format: The file system type is FAT32 and the size of the allocation unit can not exceed 4 KB. Large-capacity USB flash drive is supported. If the USB flash drive can not be used normally, format it according to the above requirements and try again. There are two ways to format a USB flash drive, namely format by using built-in function of computer system and formatting software (USB flash drive not less than 8 GB can only be formatted by the second method).

## How to set reference waveform

100 reference waveforms can be stored in the instrument, which can be displayed with current waveform simultaneously. The stored waveform can not be adjusted after being called.

The setting window of the reference waveform is shown as follows:



To store CH1 channel waveform to waveform0, operate according to the following steps

- Step
1. Open CH1 channel.
  2. Click Reference in the others module in the main setting window at the bottom right of the screen .
  3. The setting window will display on the screen. Click Switch when the switch label is highlighted on the right, it is enabled.
  4. Click 06 waveform6 from the reference waveform list.
  5. Click CH1 in the Source to highlight it.
  6. Click Save and the waveform is saved in the internal memory of the oscilloscope. It is available to customize the waveform name or save it as the waveform6 by default.
  7. Click Display can display or close the selected reference waveform.

When the switch label is highlighted on the right, it is enabled. There is a  label behind the name of reference waveform selected from the reference waveform list, the selected reference waveform is displayed on the screen and the waveform name and relevant information are displayed at the lower right corner of the reference waveform Information Box.

When the display switch is closed, the  label disappears and the reference waveform displayed on the screen will be hidden accordingly.

8. Click Label to select a common type or a Custom type. When you select a common type, you can select 31 types of labels. When you select a Custom type, you can click the input box below to enter the required labels. This function is synchronized to rename the reference waveform name.
9. Click on the value input box of the Scale to set the desired value of the stored waveform voltage.
10. Click on the value input box for Offset to set the desired vertical position of the memory waveform, click  can quickly return zero.
11. Click Reset to reset the voltage scale and vertical position of the reference waveform to the scale and position displayed in the information box.
12. Reference Waveform information box: Display the selected reference waveform.

20.00mV/div 1.000ms/div 0.00div

2026/04/29 01:13:20



Note

The reference waveform can currently save the waveform in CH1, CH2, CH3, CH4, Math, FFT mode.

## How to set waveform clone (for GDS-2000HG Series only)

Click WaveClone in other modules from the main menu window



on the lower right of the screen.

The waveform clone function can clone the waveform of one channel or two channels within the time cursor range on the screen, as a group of cloned waveform and saved to the internal storage or directly cloned to the signal generator, as the output waveform of the signal generator. A total of 4 cloned waveforms can be saved in the internal memory of the instrument.

The descriptions of Waveform Clone Menu are shown in the table below:

Menu	Setting	Description
Switch		Enable/disable the waveform clone function.
Line	X1	Turn General knob to move X1 cursor line.
	X2	Turn General knob to move X2 cursor line.
	X1&X2	Lock the distance between X1 and X2 and turn General knob to move two cursor lines simultaneously
	Full Screen	The information of the selected waveform is displayed at the lower left corner of the screen.
		<p>The screenshot shows a 'WaveClone' menu with three parameters: 'Frequency' (1/ΔX:625.0Hz), 'Time' (ΔX:1.600ms), and 'Length' (Dots:4000). Red lines connect the labels to their respective values.</p>
Wave Output	OSC AFG	Select the signal source mode.
	CH1	The signal source is the waveform of a channel, which is used to output the signal generator GEN1. In the left CH1 menu, you can specify the waveform to
	CH2 -> GEN1	
	CH1	
CH3		

	CH4 NULL CH1 CH2 -> GEN2 CH3 CH4 NULL  Clone	be cloned.  The signal source is the waveform of a channel, which is used to output the signal generator GEN2. In the left CH1 menu, you can specify the waveform to be cloned.  Clone the waveform selected by the cursor line on the screen and output it directly from the local AFG signal source.
Save&Output	0 waveform0 1 waveform1 2 waveform2 3 waveform3  Save  Rename  Output	Target waveform memory (waveform0 - waveform3, you can customize the name).  Save the waveform selected by the cursor line on the screen to one of the four target waveforms in the internal memory; when a target is selected from the left target waveform list, the information of such target will be displayed at the bottom of the cloned waveform, showing if the current target has a waveform and the signal source mode of the waveform.  Rename the target waveform as required.  Output the waveform saved in the selected target on the left.

How to quickly output the cloned waveform selected by the cursor line

- Step
1. Click WaveClone in other modules from the main menu window  on the lower right of the screen.
  2. Click Switch to enable it.
  3. Select the cursor line from the Line menu and

move to select the waveform range.

4. Select the signal source to be output CH1/CH2/CH3/CH4/NULL from the OSC Menu on the left of the waveform output (Selecting NULL indicates no output from this channel).
5. Click Clone in the menu.

For specific operations of the cursor line, refer to “How to set cursor measurement” on page 100.

### Save Cloned Waveform

---

- |      |  |
|------|--|
| Step | <ol style="list-style-type: none"><li>1. Click Wave Clone in other modules from the main menu window  on the lower right of the screen.</li><li>2. Click Switch to enable it.</li><li>3. Save the target item to be saved in the Save&amp;Output target menu.</li><li>4. Click Save in the menu or click Rename as required, then input a new target name on the input soft keyboard and click Save. The target will be displayed in the target menu with the new name.</li></ol> |
|------|--|

### Output Cloned Waveform

---

- |      |  |
|------|--|
| Step | <ol style="list-style-type: none"><li>1. Click Wave Clone in other modules from the main menu window  on the lower right of the screen.</li><li>2. Click Switch to enable it.</li><li>3. Select the target from the Save&amp;Output target menu.</li><li>4. Click Output in the menu.</li></ol> |
|------|--|

## How to conduct probe check

Click ProbeCh. In the others module of the main setting window at the bottom right of the screen . The “Probe Check” prompt box will pop up on the screen. Click Start to perform the probe check.

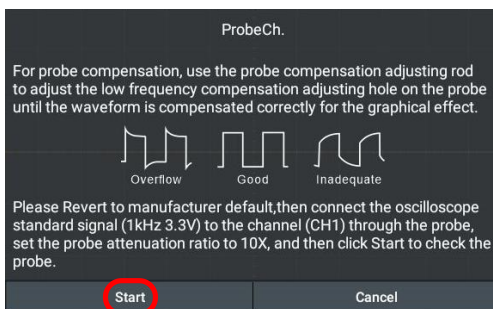

After completing the probe check, the check results are displayed on the screen and click Quit. If the result is undercompensation or overcompensation, please refer to “To set the Probe Attenuation Coefficient” on page 20 for specific operations.



## How to set network

Conduct the network settings by using LAN interface.

- If the LAN interface is used, directly insert the network cable into the LAN interface on the back of the instrument to complete the network connection.

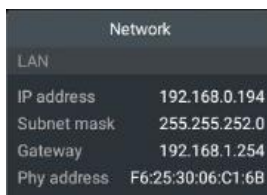

Network	
LAN	
IP address	192.168.0.194
Subnet mask	255.255.252.0
Gateway	192.168.1.254
Phy address	F6:25:30:06:C1:6B

### Default

Restore the factory settings. Click Default shortcut in the left corner of screen and click Confirm in the factory settings window, to restore the factory default state; click Cancel if it is not needed.

### About

It is composed of About the Application and About the Instrument. The former is to display the latest version of the instrument; and the latter is to show the instrument Product Model, Serial Number, System Version and CheckSum.

### Configuration

Click Config in the others module in the main setting window at the bottom right of the screen . Set up other auxiliary system functions in the instrument.

### Set Language

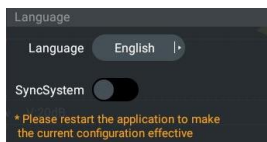

It is mainly used to set the language and choose

whether to synchronize with the system.

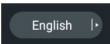
- Click on the right side of the language  to switch languages. In the process of switching languages, you need to click Confirm to restart the application for the configuration to take effect.
- If you click SyncSystem, when the switch label is highlighted on the right, it is enable, and the language is consistent with the system; If not enabled, the language is the language you set.

### Set SyncOutput

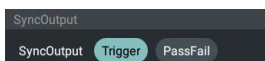

Synchronous output is generally used to synchronize trigger signals or measurement results with other devices or systems for more accurate and comprehensive measurement, analysis, and control. The output types of the synchronous output of this instrument are trigger output and pass/fail, which can help the user better control and analyze the trigger and validity of the measurement process.

- **Trigger:** The synchronous output trigger signal, that is, the trigger output in the synchronous output allows the instrument to output its internal trigger signal to other devices to control it to start measuring or recording operations.
- **PassFail:** Detects and determines whether the input signal passes the predefined upper and lower limits.

### Set Display Format

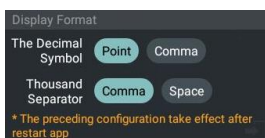

It is mainly used to set the display format of all the values in the instrument.

- Click The Decimal Symbol to display the decimal symbol as a Point or Comma.
- Click Thousand Separator to set a Comma (Point, subject to decimal symbol) or a Space between thousand separators.



## Note

If the symbol type is different from the current instrument, a prompt box “restart application to become effective” will be popped up. Click Confirm to restart the application to make the configuration effective.

## Set input box mode

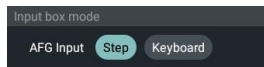

It is mainly used to set the signal source input box mode.

- Click Step to enable the mode where double-clicking the input box opens the keypad.
- Click Keyboard to enable the mode where a single click on the input box opens the keypad.

## Foundation Setting

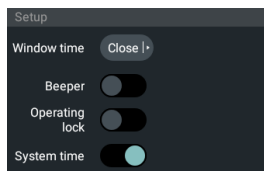

Window time: Set window display time, the value can be set Close, 5s, 10s, 15s, 20s, 25s, 30s. When the set time is up, the setting window will automatically close.

Beeper: Click Beeper when the switch label is highlighted on the right, it is enabled. After opening, there will be sound prompts for still and click operations or panel operations.

Operating lock: Click Operating lock when the switch label is highlighted on the right, it is enabled. After opening, the touch setting and panel operation are disable, you need to press the

Run/Stop button three times to unlock.

System Time: Click the switch. When the switch toggle is on the right, it is enabled. Once enabled, the system time will be displayed in the top right corner of the screen.

---

### Hardware-Test

Click Hardware-Test in the others module in the main setting window at the bottom right of the screen . The function is mainly for the self-inspection of the instrument, including screen detection and key detection, which is used to detect if there is any bright spots or bad spots on the screen, and if there is any wrong key, missing key or reversed key on the instrument.

## How to use execution keys

The execution keys include Run/Stop, Autoset and Single.

**Automatic Setting** Set various control values automatically to generate the display waveforms suitable for observation. Press Autoset key and the oscilloscope will quickly detect the signal automatically.

The Function Items for Automatic Settings are shown in the table below:

Function Item	Setting
Vertical Coupling	DC (channel coupling remains closed)
Channel switch	Signal open or close (channel switch remains closed)
Vertical Scale	Adjust to the proper scale
Channel Bandwidth	Current
Horizontal Position	Center or two squares to left or right
Horizontal Scale	Adjust to the proper scale
Trigger Type	Edge
Trigger Signal Source	CH1, CH2, CH3 or CH4
Trigger Coupling	DC
Trigger Slope	Rising
Trigger Level	At 50 % of waveform
Trigger Mode	Auto
Display Mode	YT
Math	Off
FFT	Off
Waveform Amplification	Exit
Pass fail	Current

**Autoset judge waveforms type** Set various control values automatically to generate the display waveforms suitable for observation. Press Autoset key and the oscilloscope will quickly detect the signal automatically.

**Menu display** Sine wave or Ramp wave: signal period, multi periods, cancel autoset, auxiliary menu set.



Square wave or Pulse wave: signal period, multi periods, rising edge, falling edge, cancel autoset, auxiliary menu set.



DC level: cancel autoset, auxiliary menu set.

Unknown source: cancel autoset, auxiliary menu set.

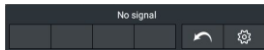

**Partial description of nouns**

Signal period: Display 1~2 waveform periods.

Multi periods: Display multiple waveform periods.

Rising edge: Separate shows a rising edge of square wave.

Falling edge: Separate shows a falling edge of square wave.

Cancel autoset: Returns information about the last menu and signal.

**Auxiliary menu set**

Click to enter the auxiliary menu system, including channel switch hold and channel coupling hold.

- Channel switch hold: Select open or close channel switch hold function. If open channel switch hold, perform autoset will detect four analog channels CH1, CH2, CH3 or CH4. If

doesn't detect channel source, it will close the channel; if detect channel source, it will adjust the best scale to display. If open channel switch hold, no signal channels are closed and perform autoselect operation only detect opening channel.

- Channel coupling hold: Select open or close channel coupling hold function. If open channel coupling hold function, perform autoselect operation, channel coupling setting remain unchanged; if close channel coupling hold function, channel coupling default is DC coupling.

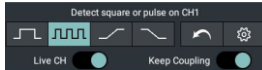

Note

If the automatic waveform setting is applied, the frequency and amplitude of the measured signal shall not be less than 20 Hz and 5 mV, respectively. If the condition is not met, the automatic waveform setting may be invalid.

Run/Stop

Run and Stop the waveform acquisition.



Note

In the stop state, the vertical gear and horizontal time base of the waveform can be adjusted within a certain range, equivalent to extend the signal in the horizontal or vertical direction. When the horizontal time base is 50 ms or less, the horizontal time base can be extended down to 4 scale.

Single

Press this key to directly set the trigger mode as single, which is to acquire a waveform when one trigger is detected and then stop acquisition.

# ARBITRARY WAVEFORM GENERATOR

## (for GDS-2000HG only)

The display window of arbitrary waveform/function generator is located at the upper right of the screen.

---

Display window .....	168
Setting .....	169
Connect the output end .....	169
Set the channel .....	170
Set the waveform .....	171
Output Built-in Waveform .....	175
Output Modulation Waveform.....	177
Output Sweep Waveform.....	179
Generate Burst.....	181

## Display window

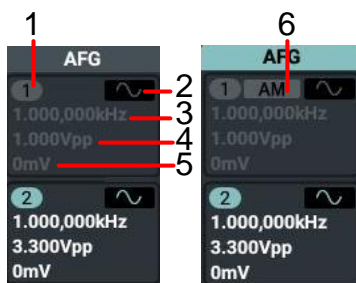

1. Display the channel name and the channel output switch status.
2. Current waveform.
3. Display the frequency/period.
4. Display the amplitude/high level.
5. Display the offset/low level.
6. Display current modulation mode.

## Setting

The display window of arbitrary waveform/function generator is located at the upper right of the screen.

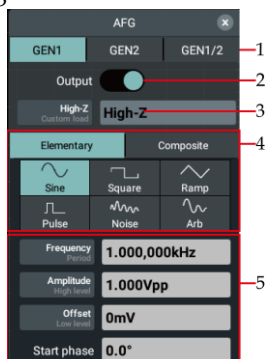

1. Select channel.
2. Enable or disable the channel output.
3. Select the load: High-Z or Custom load (Range is 1  $\Omega$  to 10 k $\Omega$ , default is 50  $\Omega$ ).
4. Waveform selection area.
5. Output parameter setting area.

## Connect the output end

Connect BNC cable to the output end of **AFG GEN 1** or **AFG GEN 2** signal generator of the oscilloscope's front panel.

Swipe right to display the signal source information for the two corresponding channels. To view the output of the signal generator, connect the other end of BNC cable to the signal input channel of the oscilloscope's front panel.

## Set the channel

- How to switch the channels displayed in the menu  
Open the signal source setting window and click GEN 1, GEN 2 or GEN 1/2 at the upper of the window to switch among Channel 1 menu, Channel 2 menu and Channel Copy menu.
- How to enable/disable the channel output  
Press ON/OFF key of two channels to enable/disable the output of corresponding channel. The key light of corresponding channel turns on when the output is enabled.
- Channel copy menu  
Press GEN 1/2 softkey to switch to the Channel Copy menu.

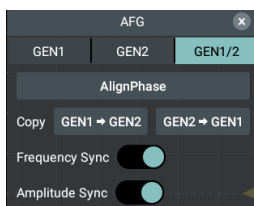

Align Phase	Click AlignPhase softkey in the menu below to align the initial phases of two channel signals.
Copy channel	Select From GEN 1→GEN 2 in the menu below to copy the parameters of Channel 1 to Channel 2. Select From GEN 2→GEN 1 in the menu below to copy the parameters of Channel 2 to Channel 1.
Frequency synchronization	Select Frequency Sync as On in the menu below. When adjusting the frequency of one channel, that of the other changes simultaneously.
Amplitude synchronization	Select Amplitude Sync as On in the menu below. When adjusting the amplitude of one channel, that of the other changes simultaneously.

## Set the waveform

- Step
1. Click GEN1 or GEN2 display window to display the setting window of the signal generator.
  2. Select the waveform required and corresponding waveform setting menu from the menu items at the lower part of the window.
  3. Operate the setting menu to set the parameters of the waveform required.

Example Press Frequency in the menu below (if there is only Period other than Frequency, click the title to switch it to Frequency), and set the required value, the specific methods are as follows.

There are 3 methods to change the parameter values selected:

- Use digital soft keyboard input mode: Click Numeric Display Box and the soft keyboard appears, and input the required value directly.

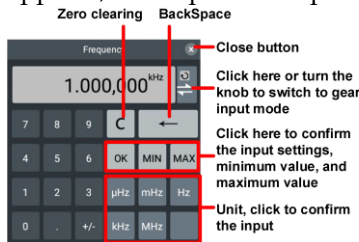

- Use gear input mode:

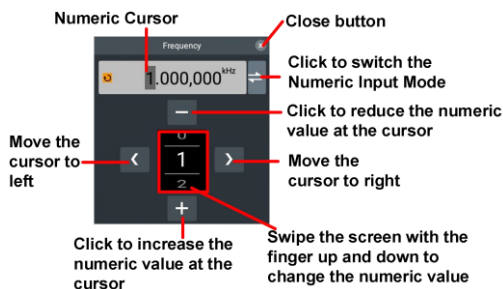

- Use General Knob: Turn General Knob to increase or decrease the value at the cursor.  
Press / to move the cursor left and right, see the gear input mode diagram for details.

Parameters that can be set for each waveform:

Name	Menu Items
Sine	Frequency/Period, Amplitude/High level, Offset/Low level, Start phase
Square	Frequency/Period, Amplitude/High level, Offset/Low level, Start phase
Ramp	Frequency/Period, Amplitude/High level, Offset/Low level, Start phase, Symmetry
Pulse	Frequency/Period, Amplitude/High level, Offset/Low level, Start phase, PulseWidth/Duty cycle
Noise	Amplitude/High level, Offset/Low level
Arbitrary	Frequency/Period, Amplitude/High level, Offset/Low level, Start phase, Built-in/External

Taking output sine wave as an example, the setting steps are as follows:

Click the AFG information display bar on the right of the screen, and the screen displays the AFG setting window, as shown below:

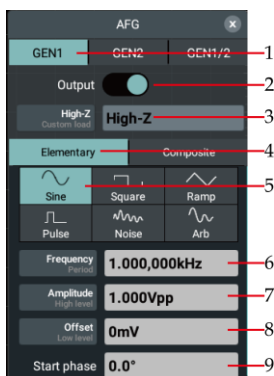

1. Click GEN1 at the setting window.
2. Enable or disable the channel output.
3. Click High-Z/Custom load to set the required load mode, and the custom load ranges from 1  $\Omega$  to 10 k $\Omega$ .
4. Select Elementary.
5. Select Sine for the waveform type.
6. Set Frequency/Period; when the frequency font is white and the cycle font is gray, the frequency value can be set; when the frequency font is gray and the cycle font is white, the cycle value can be set. Click Frequency/Cycle to switch between the frequency and the cycle.
7. Set Amplitude/High level; when the amplitude font is white and the high level font is gray, the amplitude value can be set; when the amplitude font is gray and the high level font is white, the high level value can be set. Click Amplitude/High level to switch between the amplitude and the high level.
8. Set Offset/Low level; when the offset font is white and the low level font is gray, the offset value can be set; when the offset font is gray and the low level font is white, the low level value can be set. Click Offset/Low Level to switch between the offset and the low level.
9. Set Start phase; click Numeric Display Box to set the phase parameters in the setting box. For specific setting mode, refer to “Three Methods to Change the Selected Parameter Value”.

**Note**

For the parameter settings of square wave, ramp wave, pulse wave and noise wave, refer to the operations mentioned above.

---

## Output Built-in Waveform

There are 28 kinds of built-in waveforms. To select the built-in waveform, follow the steps below:

- |      |   |
|------|---|
| Step | <ol style="list-style-type: none"> <li>1. Click GEN 1 or GEN 2 display window to display the setting window of the signal generator.</li> <li>2. Select Arb in the menu below and click Built-in/External.</li> <li>3. Select the classification of the built-in wave in the menu: Engineering, Maths, Medical, Trigonometric or Others. For example, select Others.</li> <li>4. Click DC to output the DC voltage waveform.</li> </ol> |
|------|---|

Built-in Waveform Table

Name	Explanation
Engineering	
Butterworth	Butterworth filter
Combin	Combined function
CPulse	C-Pulse signal
RoundsHalf	Half-round wave
BandLimited	Band limited signal
BlaseiWave	Blasting vibration "time-vibration speed" curve
Chebyshev1	Type I Chebyshev filter
Chebyshev2	Type II Chebyshev filter
DampedOsc	Damped oscillation "time-displacement" curve
DualTone	Dual audio signal
Maths	
Besselj	Type I Bessel function
Bessely	Type II Bessel function
Log	Base 10 logarithmic function
X^2	Square function

X <sup>3</sup>	Cubic function
Medical	
LFPulse	Low frequency pulse electrotherapy waveform
Tens1	Neuroelectric stimulation therapy waveform 1
EOG	Electrooculogram
Trigonometric	
CosH	Hyperbolic cosine
Cot	Cotangent function
CotH	Hyperbolic cotangent
CotHCon	Concave hyperbolic cotangent
Csc	Cosecant
CscCon	Recessed cosecant
CscPro	Raised cosecant
Csch	Hyperbolic cosecant
CochCon	Depressed hyperbolic cosecant
Others	
DC	DC signal

## Output Modulation Waveform

Supported modulation types include: Amplitude Modulation (AM), Frequency Modulation (FM), Phase Modulation (PM) and Frequency-shift Keying (FSK).

Click the AFG information display bar at the right side of the screen to pop up the AFG setting window, click Composite and select Modulation; click Type menu to select the modulation type. To disable the modulation, pop up the signal source setting window again, select Continue in the Composite.

Parameters that can be set for various modulation types.

Type	Setting
AM	Mod.Wave, Mod.Freq, Mod.Depth
FM	Mod.Wave, Mod.Freq, Frequency deviation
PM	Mod.Wave, Mod.Freq, Phase.Dev
FSK	Mod.Freq, Hop Freq

Taking the Amplitude Modulation (AM) parameters as an example, the setting steps are as follows:

- |      |   |
|------|---|
| Step | <ol style="list-style-type: none"> <li>1. Click the AFG information display bar at the right side of the screen to pop up the AFG setting window.</li> <li>2. Select Composite and select Modulation.</li> <li>3. Click Type menu and select AM as the modulation type.</li> <li>4. Click Mod.Wave and select the modulation waveform required, including Sine Wave, Square Wave, Ramp Wave and Noise Wave.</li> <li>5. Click Mod.Freq to set the modulation frequency required. Refer to “Three Methods to Change the Selected Parameter Values” for specific setting mode.</li> <li>6. Click Mod.Depth to set the modulation depth required. Refer to “Three Methods to Change</li> </ol> |
|------|---|

the Selected Parameter Values” for specific setting mode.

For the parameter settings of Frequency Modulation (FM), Phase Modulation (PM) and Frequency-shift Keying (FSK), refer to “Amplitude Modulation (AM)” for details.

## Output Sweep Waveform

In the sweep mode, the output varies from the start frequency to stop frequency within the specific scan time. Only sine wave, square wave, sawtooth wave or arbitrary wave (except DC) can be used to product sweep waveforms.

When the output signal is sine wave, square wave, ramp wave or arbitrary wave, click the AFG information display bar at the right side of the screen to pop up the AFG setting window, then click Sweep in the Composite to enter the sweep mode.

- 
- |                   |   |
|-------------------|---|
| Set sweep time    | Click Sweep Time to set the sweep time, that is, the seconds required from the start frequency to the stop frequency, ranging from 1 ms to 500 s.   |
| Set sweep mode    | Click Sweep Way to set the sweep mode as Linear or Log.<br><br>When Linear is selected, the output frequency varies linearly during the sweep period.<br><br>When Log is selected, the output frequency varies logarithmically during the sweep period.   |
| Set the frequency | Click StartFreq/CtrFreq to display "StartFreq" in white. Please note that "StopFreq" in StopFreq/FreqSpan is also displayed in white; click Numeric Display Box to input the required frequency value.<br><br>You can also set the frequency boundary for frequency sweep through the center frequency and frequency range.<br><br>Center Frequency = (Start Frequency + Stop Frequency)/2<br><br>Frequency Range = Stop Frequency - Start Frequency<br><br>Click StartFreq/ CtrFreq to display "CtrFreq" in white. Please note that "Freq Span" in StopFreq/FreqSpan is also displayed in white; click Numeric Display Box to input the required |

frequency value.



The Start Frequency and Stop Frequency are the upper limit and lower limit of the sweep frequency. The signal generator always sweeps from the start frequency to the stop frequency and back to the start frequency.

Set the trigger source

Click Internal to use internal signal source

Click Manual to select manual trigger; when the trigger source is switched to Manual, the Manual Trigger softkey will be displayed below. Click this soft key to perform a frequency sweep trigger.

To disable Sweep, pop up the signal source setting window again, and select Continuous in the Composite.

## Generate Burst

Click the AFG information display bar at the right side of the screen to pop up the AFG setting window, click Burst in the Composite to generate pulse train waveform output of various waveform functions. The pulse trains can last a specific number of waveform cycles (N cycle pulse trains). Sine wave, square wave, sawtooth wave, pulse wave or arbitrary wave functions can be used (this function is unavailable for noise wave).

In N-cycle mode, Period, N-cycle/Gated and Trigger can be set.

To set the N-cycle pulse train parameters under the sine wave, the operating steps are as follows:

---

- | Step |   |
|------|---|
|      | 1. Click Burst in the Composite.  |
|      | 2. Click Period to set the trigger cycle required.  |
|      | 3. Click N-cycle/Gated to display the Number of Cycle in white; then click Numeric Display Box to set the number of cycles required, ranging from 1 to 60,000 (Max=Burst Period/ Period).   |
|      | 4. Set Trigger, click Internal to use the internal signal source, the signal generator can only output n-cycle burst, and the burst frequency is determined by the burst cycle. Burst cycles are only available when cycles and internal triggers are highlighted. Press Burst Cycle soft key to set the burst cycle, that is the time from the start of one burst to the start of the next, ranging from 40 ns to 500 s (minimum value = number of cycles * cycles). |
|      | 5. Click Manual to select Manual Trigger. When the trigger source is switched to Manual, the Manual Trigger softkey will be displayed below, click this softkey to output a pulse train.  |

# SPECIFICATIONS

Model	GDS-2254HD/HG	GDS-2354HD/HG	GDS-2504HD/HG
Bandwidth	250 MHz	350 MHz	500 MHz <sup>[1]</sup>
Channel	4 Ch + EXT	4 Ch + EXT	4 Ch + EXT
Bandwidth Limit	20 MHz	20 MHz	20 MHz
Calculated Rise Time	1.75 ns	1 ns	0.7 ns
Vertical Sensitivity			
Resolution	12 bit ; 1 M $\Omega$ : 500 $\mu$ V/div to 10 V/div; 50 $\Omega$ : 500 $\mu$ V/div to 1 V/div <sup>[2]</sup>		
Input Coupling	AC, DC, GND		
Input Impedance	1 M $\Omega$ $\pm$ 2 %; in parallel with 15 pF $\pm$ 5 pF; 50 $\Omega$ $\pm$ 2 %		
DC Gain Accuracy	$\leq$ 1 mV $\pm$ 3 %; 2 mV $\pm$ 2 %; $\geq$ 5 mV $\pm$ 1.5 %		
Polarity	Normal & Invert		
Maximum Input Voltage	1 M $\Omega$ $\leq$ 300 Vrms, CAT II; 50 $\Omega$ $\leq$ 5 Vrms		
Offset Position Range	For 1 M $\Omega$ input impedance: 500 $\mu$ V/div to 50 mV/div: $\pm$ 2 V; 100 mV/div to 500 mV/div: $\pm$ 20 V; 1 V/div to 10 V/div : $\pm$ 200 V ; For 50 $\Omega$ input impedance: 500 $\mu$ V/div to 50 mV/div: $\pm$ 2 V; 100 mV/div to 1 V/div: $\pm$ 5 V		
Waveform Signal Process	+, -, $\times$ , $\div$ , FFT, User Defined Expression, FFT: 1 Mpts ; FFT: Spectral magnitude, Set FFT Vertical Scale to Vrms, dBVrms, Radians or Degrees, FFT Window Displays : Rectangle, Hamming, Hanning, Blackman, Bartlett or Kaiser		
Trigger			
Source	CH1, CH2, CH3, CH4, EXT TRIG, AC Lines		
Trigger Mode	Auto, Normal, Single		
Trigger Type	Edge, Pulse Width (Glitch), Video, Pulse Runt, Rise & Fall (Slope), Windows, Nth, Logic, Time out, Bus (I <sup>2</sup> C, SPI, RS232/UART, CAN, LIN)		

Holdoff range	100 ns to 10 s
Coupling	AC, DC, HF
Sensitivity	0.3 div to 10 div
<b>EXT Trigger</b>	
Range	EXT $\pm 2$ V; EXT/5 $\pm 10$ V
Sensitivity	DC to 5 MHz EXT: 150 mV; DC to 5 MHz EXT/5: 750 mV
Input Impedance	1 M $\Omega$ $\pm$ 2 %; in parallel with 15 pF $\pm$ 5 pF
<b>Horizontal</b>	
Time base Range	500 ps/div to 1000 s/div (1-2-5 increments)
Pre-trigger	10 div maximum
Post-trigger	80,000,000 div maximum
Time base Accuracy	$\pm 1$ ppm, about $\pm 1$ ppm increase in error per year
Peak Detection	0.8 ns (typical)
<b>Signal Acquisition</b>	
Real Time Sample Rate	2.5 GSa/s (half channel) <sup>[3]</sup> ; 1.25 GSa/s (all channels)
Record Length	Max. 500 Mpts/ CH <sup>[4]</sup>
Acquisition Mode	Sample, Peak, High Res, Average, Segmentation
Average	4, 16, 64, 128, 256, 512, 1024, 2048, 4096, 8192, 16384, 32768, 65536 selectable
<b>X-Y Mode</b>	
X-Axis Input	User defined
Y-Axis Input	User defined
Phase Shift	$\pm 3$ degrees at 100 kHz
<b>Cursors and Measurement</b>	
Cursors	Amplitude, Time, Gating available; FFT <sup>[5]</sup> ; Unit: Seconds (s), Hz (1/s), Phase (degree), Ratio (%), FFT Vrms (V), FFT dBVrms(dB), FFT Radians (RAD), FFT Degrees (°)
Automatic Measurement	43 sets: Period, Frequency, +Width, -Width, Rise Time, Fall Time, Scr Duty, +Duty, -Duty, Vavg, Vpp, VRMS, Overshoot, Vmax, Vmin, Vtop, CycRms, Vbase, Vamp, Preshoot, Std Dev, +Pulse Cnt, -Pulse Cnt, Rise Cnt, Fall Cnt, Area, Cyc Area, Delay (A $\uparrow$ -B $\uparrow$ ), Delay (A $\uparrow$ -B $\downarrow$ ), Delay (A $\downarrow$ -B $\uparrow$ ), Delay (A $\downarrow$ -B $\downarrow$ ), Phase (A $\uparrow$ -B $\uparrow$ ), Phase (A $\uparrow$ -B $\downarrow$ ), Phase (A $\downarrow$ -B $\uparrow$ ), Phase (A $\downarrow$ -B $\downarrow$ ), FRR (A $\uparrow$ -B $\uparrow$ ), FRF (A $\uparrow$ -B $\downarrow$ ), FFR (A $\downarrow$ -B $\uparrow$ ), FFF (A $\downarrow$ -B $\downarrow$ ), LRR(A $\uparrow$ -B $\uparrow$ ), LRF (A $\uparrow$ -B $\downarrow$ ), LFR (A $\downarrow$ -B $\uparrow$ ),

	LFF (A ↓ -B ↓)
Cursors Measurement	Manual mode: Voltage difference between cursors ( $\Delta V$ ) Time difference between cursors ( $\Delta T$ ) Tracing mode: The voltage value and time value of the X waveform point are tracked by fixing the Y-axis The fixed X-axis tracks the voltage value and time value of the Y waveform point.
Auto Counter	6 digits, range from 2 Hz minimum to the rated bandwidth
Control Panel Function	
Autoset	Single button, automatic setup of all channels for vertical, horizontal and trigger systems, with "Undo Autoset"
Save Setup	10 sets
Save Waveform	Maximum 3 GB of available internal storage space <sup>[6]</sup>
Save Reference Waveform	100 sets
AFG Specifications (GDS-2000HG series)	
Channel	2
Sample Rate	160 MSa/s
Vertical Resolution	14 bits
Max. Frequency	50 MHz
Waveform	Sine wave, square wave, ramp wave, pulse wave, Noise wave, Butterworth, X <sup>2</sup> and EOG etc 28 built-in waveforms
Output Range	High Z: 2 mVpp to 10 Vpp ( $\leq 10$ MHz) ; 2 mVpp to 5 Vpp ( $\leq 50$ MHz); 50 $\Omega$ : $\pm 2.5$ Vpk - Amplitude Vpp/2 ( $\leq 10$ MHz) ; $\pm 1.25$ Vpk - Amplitude Vpp/2 ( $\leq 50$ MHz)
Output Resolution	1 mVpp or 5 bits
Output Accuracy	$\pm (1\%$ of setting + 1 mVpp) (typical 1 kHz sine, 0 V offset)
Offset Range	High Z: $\pm 5$ Vpk - Amplitude Vpp/2 ( $\leq 10$ MHz) ; $\pm 2.5$ Vpk - Amplitude Vpp/2 ( $\leq 50$ MHz) 50 $\Omega$ : $\pm 2.5$ Vpk - Amplitude Vpp/2 ( $\leq 10$ MHz) ; $\pm 1.25$ Vpk - Amplitude Vpp/2 ( $\leq 50$ MHz)
Offset Resolution	1 mVpp
Sine	
Frequency Range	1 $\mu$ Hz to 50 MHz

Flatness	$\leq 10$ MHz : $\pm 0.3$ dB ; $\leq 50$ MHz : $\pm 0.5$ dB
Harmonic Distortion	Typical value (0 dBm); DC to 1 MHz: $< -65$ dBc; 1 MHz to 50 MHz: $< -50$ dBc
Stray (Non-harmonic)	Typical value(0 dBm); $\leq 10$ MHz: $< -70$ dBc; $> 10$ MHz: $< -70$ dBc + 6 dBc/octave
Total Harmonic Distortion	$< 0.2$ %, 10 Hz to 20 kHz, 1 Vpp
S/N Ratio	40 dB <sup>[7]</sup>
Square/Pulse	
Frequency Range	Square: 1 $\mu$ Hz to 20 MHz; Pulse: 1 $\mu$ Hz to 10 MHz
Rise/Fall time	$< 15$ ns
Overshoot	$< 5$ %
Duty cycle	Square: 50 %; Pulse: 0.1 % to 99.9 %
Min. Pulse Width	$\geq 64$ ns
Jitter	200 ps +25 ppm
Ramp	
Frequency Range	1 $\mu$ Hz to 1 MHz
Linearity	$< 1$ % of maximum output (typical value 1 kHz, 1 Vpp, symmetry 50 %)
Symmetry	0 % to 100 %
NOISE	
Type	Gaussian white noise
Bandwidth (-3dB)	20 MHz
ARBITRARY	
Bandwidth	10 MHz
Waveforms Length	2 to 16384 points
Sample Rate	160 MSa/s
Amplitude Accuracy	14 bits
MODULATION CHARACTERISTIC	
Modulate Type	AM, FM, PM, FSK
AM	
Carrier	Sine, Square, Ramp, Arb(Except DC)
Internal Modulation Waveform	Sine, Square, Ramp, Noise
Internal Amplitude Modulation Frequency	2 mHz to 20 kHz
Depth	0 % to 100 %

FM	
Carrier	Sine, Square, Ramp, Arb(Except DC)
Internal Modulation Waveform	Sine, Square, Ramp, Noise
Internal Amplitude Modulation Frequency	2 mHz to 20 kHz
Frequency Offset	2 mHz to min (Carrier frequency setting: take the smaller value between the set carrier frequency and the maximum carrier frequency.)
PM	
Carrier	Sine, Square, Ramp, Arb(Except DC)
Internal Modulation Waveform	Sine, Square, Ramp, Noise
Internal Amplitude Modulation Frequency	2 mHz to 20 kHz
Phase Deviation Range	0° to 180°
FSK	
Carrier	Sine, Square, Ramp, Arb(Except DC)
FSK Rate	2 mHz to 100 kHz
FSK Hopfreq	1 μHz to Maximum frequency of corresponding carrier
SWEEP	
Carrier	Sine, Square, Ramp, Arb(Except DC)
Min/Max Start Frequent	1 uHz(minimum)/Maximum frequency of corresponding carrier
Max/Min Stop Frequent	1 uHz(minimum)/Maximum frequency of corresponding carrier
Type	Linear, Log
Sweep Time	1 ms to 500 s ± 0.1 %
Trigger Source	Internal, Manual
BURST	
Waveforms	Sine, Square, Ramp, Pulse and Arb(Except DC)
Carrier Frequency	1 uHz to Maximum frequency of corresponding carrier /2
Trigger Source	Manual, Internal
N-cycle Trigger Cycle	1 us to 500 s
N Periodicity	1 to 60000 (Max = Burst Period / Period)/infinite

VOLTAGE RANGE AND SENSITIVITY (No Modulation Source)	
Input Resistance	1 M $\Omega$
Display	
TFT LCD Type	10.1 inch, LCD
Display Resolution	1024 horizontal $\times$ 600 vertical pixels
Interpolation	Auto, Sin(x)/x, x
Waveform Display	Dots, vectors, variable persistence (1 s, 2 s, 5 s), infinite persistence
Waveform Capture Rate	Real-time acquire: 50,000 wfms/s; Segment acquire : 500,000 wfms/s <sup>[8]</sup>
Display Graticule	10 $\times$ 18 divisions
Display mode	YT, XY
Interface	
USB port	USB 2.0 High speed host port X3, USB 2.0 High speed device port X1
Ethernet Port (LAN)	RJ45 connector X1, 10/100 Mbps with HP Auto MDIX
Power Supply	Type-C power supply interface <sup>[9]</sup>
Miscellaneous	
Multi-language menu	Available
Operation environment	Working Temperature: 0 $^{\circ}$ C to 40 $^{\circ}$ C; Storage temperature: -20 $^{\circ}$ C to 60 $^{\circ}$ C; Relative Humidity $\leq$ 90 %
Power consumption	Power Supply: AC 100 V to 240 VACRMS, 50 Hz to 60 Hz; Power Consumption: Without generator < 35 W, With generator < 50 W
Dimensions	325 mm(W) $\times$ 209.5 mm(H) $\times$ 111.5 mm(D)
Weight	Approx. 3.2 kg

## NOTE :

- [1] 500 MHz bandwidth is available in the following cases: only one channel is enabled in each channel pair (CH1/CH2 and CH3/CH4).
- [2] 500  $\mu$ V/div is a digital magnification of 1 mV/div.
- [3] Limited to four-channel models, the maximum real-time sampling rate of two channels should meet one of the following conditions: only one channel of CH1 and CH2 can be turned on, and only one channel of CH3 and CH4 can be turned on.
- [4] Bandwidth 350 MHz and 500 MHz: up to 500 Mpts in single-channel mode, 250 Mpts in dual-channel mode; Bandwidth 250 MHz: up to

100 Mpts.

- [5] The measurement function supports cursors, available in the measurement menu settings.
- [6] Waveform data up to 100 MB memory length can be stored in internal memory. Waveform data exceeding 100 MB memory length must be saved to an external USB drive or external hard drive.
- [7] Tested is under 10 MHz, 0 dBm conditions.
- [8] Test conditions: single channel, 1 k memory depth.
- [9] The adapter or battery should support the 12 V handshake protocol, with a power requirement of 48 W.

## Certificate Of Compliance

We

**GOOD WILL INSTRUMENT CO., LTD.**

declare that the CE marking mentioned product

satisfies all the technical relations application to the product within the scope of council:

Directive: EMC; LVD; WEEE; RoHS

The product is in conformity with the following standards or other normative documents:

© EMC	
EN 61326-1	Electrical equipment for measurement, control and laboratory use — EMC requirements
Conducted & Radiated Emission EN 55011 / EN 55032	Electrical Fast Transients EN 61000-4-4
Current Harmonics EN 61000-3-2 / EN 61000-3-12	Surge Immunity EN 61000-4-5
Voltage Fluctuations EN 61000-3-3 / EN 61000-3-11	Conducted Susceptibility EN 61000-4-6
Electrostatic Discharge EN 61000-4-2	Power Frequency Magnetic Field EN 61000-4-8
Radiated Immunity EN 61000-4-3	Voltage Dip/ Interruption EN 61000-4-11 / EN 61000-4-34
© Safety	
EN 61010-1:	Safety requirements for electrical equipment for measurement, control, and laboratory use - Part 1: General requirements

**GOODWILL INSTRUMENT CO., LTD.**

No. 7-1, Jhongsing Road, Tucheng District, New Taipei City 236, Taiwan

Tel: [+886-2-2268-0389](tel:+886-2-2268-0389)

Fax: [+886-2-2268-0639](tel:+886-2-2268-0639)

Web: <http://www.gwinstek.com>

Email: [marketing@goodwill.com.tw](mailto:marketing@goodwill.com.tw)

**GOODWILL INSTRUMENT (SUZHOU) CO., LTD.**

No. 521, Zhujiang Road, Snd, Suzhou Jiangsu 215011, China

Tel: [+86-512-6661-7177](tel:+86-512-6661-7177)

Fax: [+86-512-6661-7277](tel:+86-512-6661-7277)

Web: <http://www.instek.com.cn>

Email: [marketing@instek.com.cn](mailto:marketing@instek.com.cn)

**GOODWILL INSTRUMENT EURO B.V.**

De Run 5427A, 5504DG Veldhoven, The Netherlands

Tel: [+31-\(0\)40-2557790](tel:+31-(0)40-2557790)

Fax: [+31-\(0\)40-2541194](tel:+31-(0)40-2541194)

Email: [sales@gw-instek.eu](mailto:sales@gw-instek.eu)