

Programmable AC/DC Power Source

ASR-2000 Series

USER MANUAL



ISO-9001 CERTIFIED MANUFACTURER

GW INSTEK

This manual contains proprietary information, which is protected by copyright. All rights are reserved. No part of this manual may be photocopied, reproduced or translated to another language without prior written consent of Good Will company.

The information in this manual was correct at the time of printing. However, Good Will continues to improve products and reserves the rights to change specification, equipment, and maintenance procedures at any time without notice.

Good Will Instrument Co., Ltd.
No. 7-1, Jhongsing Rd., Tucheng Dist., New Taipei City 236, Taiwan.

Table of Contents

SAFETY INSTRUCTIONS	5
GETTING STARTED.....	9
ASR-2000 Series Overview	10
Appearance	15
Theory of Operation	24
OPERATION	32
Set Up	34
Menu Tree	58
Basic Operation.....	63
Advanced Settings	103
External Keypad Operation	111
EXTERNAL CONTROL	112
Using External Control I/O	113
Using External Signal Input Function	114
Compiling Arbitrary Waveform Input	118
MISCELLANEOUS	128
T Ipeak, hold	129
IPK CLR	131
Power ON	132
Buzzer	134
Remote Sense.....	135
Slew Rate Mode.....	137
Output Relay	139
THD Format	140
External Control.....	142
V Unit.....	143
ACin Detection	144







Trigger Out Width	146
Data Average Count	149
Data Update Rate	150
TEST MODE FUNCTION	151
Sequence Mode	152
Simulate Mode	169
COMMUNICATION INTERFACE	182
Interface Configuration	183
FAQ	202
APPENDIX	203
Firmware Update	203
Factory Default Settings	205
Error Messages & Messages	210
Specifications	216
Information of Name Order	225
ASR-2000 Dimensions	226
Declaration of Conformity	230
Maintenance & Regular Inspection	231
INDEX	233

S SAFETY INSTRUCTIONS

This chapter contains important safety instructions that you must follow during operation and storage. Read the following before any operation to ensure your safety and to keep the instrument in the best possible condition.

Safety Symbols

These safety symbols may appear in this manual or on the instrument.

	WARNING	Warning: Identifies conditions or practices that could result in injury or loss of life.
	CAUTION	Caution: Identifies conditions or practices that could result in damage to the ASR-2000 or to other properties.
	DANGER	High Voltage
	Attention	Refer to the Manual
	Protective Conductor Terminal	
	Earth (ground) Terminal	



Do not dispose electronic equipment as unsorted municipal waste. Please use a separate collection facility or contact the supplier from which this instrument was purchased.

Safety Guidelines

General Guideline



CAUTION

- Do not place any heavy object on the ASR-2000.
- Avoid severe impact or rough handling that leads to damaging the ASR-2000.
- Do not discharge static electricity to the ASR-2000.
- Use only mating connectors, not bare wires, for the terminals.
- Do not block the cooling fan opening.
- Do not disassemble the ASR-2000 unless you are qualified.
- If the equipment is used in a manner not specified by the manufacturer, the protection provided by the equipment may be impaired.

(Measurement categories) EN 61010-1:2010 specifies the measurement categories and their requirements as follows. The ASR-2000 doesn't fall under category II, III or IV.

- Measurement category IV is for measurement performed at the source of low-voltage installation.
 - Measurement category III is for measurement performed in the building installation.
 - Measurement category II is for measurement performed on the circuits directly connected to the low voltage installation.
 - 0 is for measurements performed on circuits not directly connected to Mains.
-

- Power Supply
-  WARNING
- AC Input voltage range:
100 ~ 240 Vac
 - Frequency: 47 ~ 63 Hz
 - To avoid electrical shock connect the protective grounding conductor of the AC power cord to an earth ground.
 - The power switch that is included in the instrument is not considered a disconnecting device.
 - The power cord set is used as the disconnecting device and shall remain readily operable.
 - Do not position the equipment so that it is difficult to operate the disconnecting device.
 - Do not replace the power supply cord with an improperly rated cord. A certified power supply cord should not lighter than light PVC sheathed flexible cord according to IEC 60227, designation H05VV-F, and be rated for at least 3G 0.75 mm² (for rated current up to 10 A) or 3G 1.0mm² (for rated current over 10 A up to 16 A) wire or larger, and the length of the cord that does not exceed 2 m must be used.
-
- Cleaning the ASR-2000
- Disconnect the power cord before cleaning.
 - Use a soft cloth dampened in a solution of mild detergent and water. Do not spray any liquid.
 - Do not use chemicals containing harsh material such as benzene, toluene, xylene, and acetone.
-
- Operation Environment
- Location: Indoor, no direct sunlight, dust free, almost non-conductive pollution (Note below)
 - Relative Humidity: 20%~ 80%, no condensation
 - Altitude: < 2000m
 - Temperature: 0°C to 40°C

(Pollution Degree) EN 61010-1:2010 specifies the pollution degrees and their requirements as follows. The ASR-2000 falls under degree 2.

Pollution refers to “addition of foreign matter, solid, liquid, or gaseous (ionized gases), that may produce a reduction of dielectric strength or surface resistivity”.

- Pollution degree 1: No pollution or only dry, non-conductive pollution occurs. The pollution has no influence.
- Pollution degree 2: Normally only non-conductive pollution occurs. Occasionally, however, a temporary conductivity caused by condensation must be expected.
- Pollution degree 3: Conductive pollution occurs, or dry, non-conductive pollution occurs which becomes conductive due to condensation which is expected. In such conditions, equipment is normally protected against exposure to direct sunlight, precipitation, and full wind pressure, but neither temperature nor humidity is controlled.

Storage environment

- Location: Indoor
- Temperature: -10°C to 70°C
- Relative Humidity: ≤90%, no condensation

Disposal



Do not dispose this instrument as unsorted municipal waste. Please use a separate collection facility or contact the supplier from which this instrument was purchased. Please make sure discarded electrical waste is properly recycled to reduce environmental impact.

G E T T I N G S T A R T E D

This chapter describes the ASR-2000 power supply in a nutshell, including its main features and front / rear panel introduction.

ASR-2000

ASR-2000R



ASR-2000 Series Overview	10
Series lineup	10
Operating Area	10
Main Features	12
Accessories	13
Appearance	15
Front Panel.....	15
Rear Panel.....	20
Status Bar Icons	23
Theory of Operation	24
Description of ASR-2000 System	24
Glossary	25
Alarms	27
Considerations	29
Grounding.....	31

ASR-2000 Series Overview

Series lineup

The ASR-2000 series consists of 4 models, the ASR-2050, ASR-2100, ASR-2050R and ASR-2100R, differing only in capacity and front panel output. Note that throughout the user manual, the term “ASR-2000” refers to any of the models, unless stated otherwise.

Model Name	Power Rating	Max. Output Current	Max. Output Voltage
ASR-2050	500 VA	5 / 2.5 A	350 Vrms / 500 Vdc
ASR-2100	1000 VA	10 / 5 A	350 Vrms / 500 Vdc
ASR-2050R	500 VA	5 / 2.5 A	350 Vrms / 500 Vdc
ASR-2100R	1000 VA	10 / 5 A	350 Vrms / 500 Vdc

Operating Area

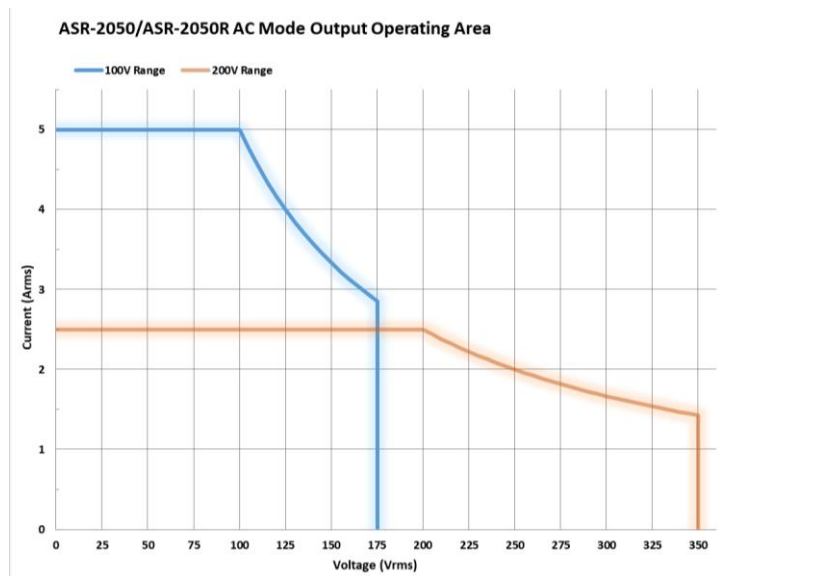

ASR-2050/ASR-2050R DC Mode Output Operating Area

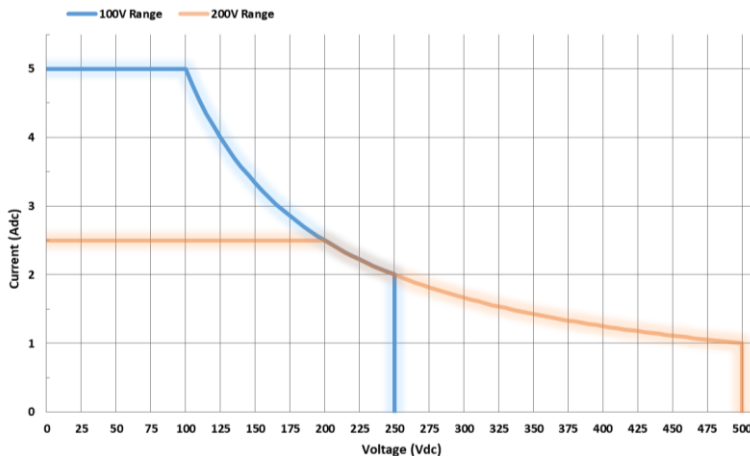

ASR-2100/ASR-2100R AC Mode Output Operating Area

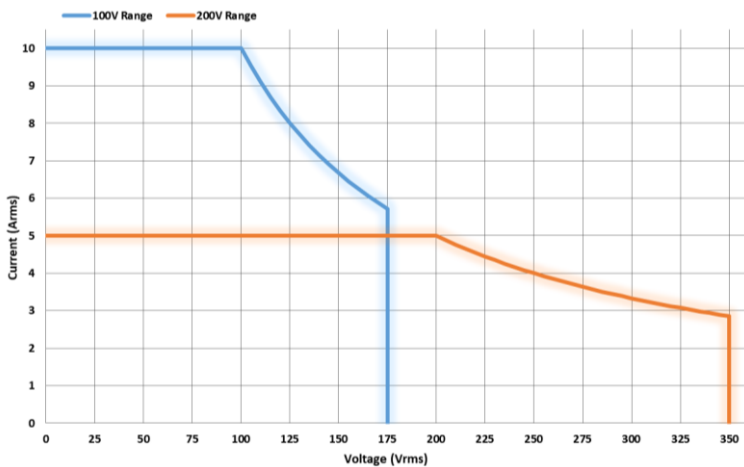

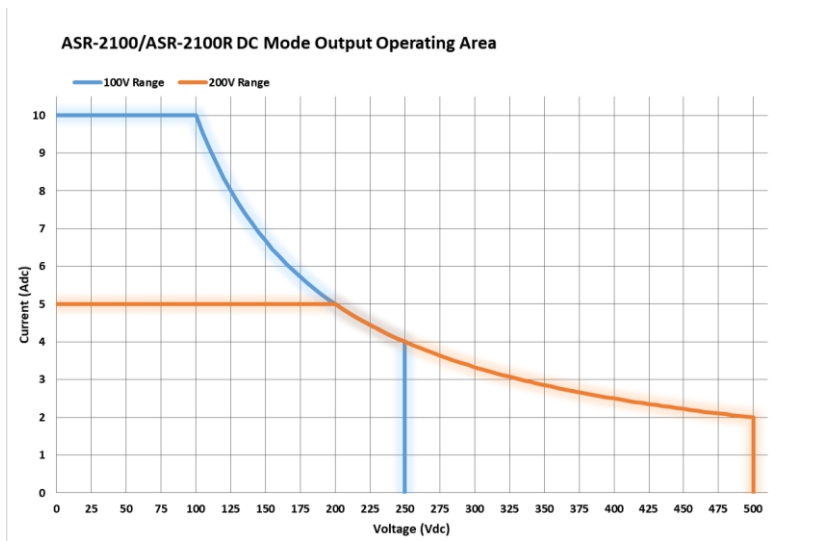

Main Features

- Performance
- Maximum AC output voltage is 350 Vrms
 - Maximum DC output voltage is 500 Vdc
 - Maximum output frequency is 999.9 Hz in AC mode
 - Supported AC+DC waveform application
 - DC full capacity output ability
 - Output voltage total harmonic distortion is less than 0.5% at all frequency
 - Crest factor reached 4 times high
-

Features	<ul style="list-style-type: none"> • Include sine, square, triangle, arbitrary and DC output waveforms • Variable voltage, frequency and current limiter • Harmonic voltage and current analysis ability • Excellent and feature-rich measurement capacity • Sequence and simulate function • External input amplification • AC line synchronized output • Preset memory function • USB memory support • Remote sense • OCP, OPP and OTP protection function
----------	---

Interface	<ul style="list-style-type: none"> • Built-in LAN, USB host, USB device and RS232 • External control I/O • External signal input • Factory option GPIB interface
-----------	--

Accessories

Before using the ASR-2000 power source unit, check the package contents to make sure all the standard accessories are included.

Standard Accessories	Part number	Description
	CD ROM	User manual, programming manual
	82GW1SAFE0M*1	Safety guide
	Region dependent	Power cord
	63SC-XF101601 x 1	Mains terminal cover set
	63SC-XF101701 x 1	Remote sensing cover set
	GTL-123	Test leads: 1x red, 1x black

	GTL-246	USB CABLE (USB 2.0 Type A- Type B Cable, Approx. 1.2M)
Factory Installed Options	Part number	Description
	ASR-GPIB-2K	Optional GPIB Interface for ASR-2000
	ASR-UR-2K	European Output Outlet only for ASR-2000
Optional Accessories	Part number	Description
	GET-003	Universal extended terminal box (ASR-2000R only)
	GET-004	EURO extended terminal box (ASR-2000R only)
	GRA-439-E	Rack mount adapter (EIA)
	GRA-439-J	Rack mount adapter (JIS)
	GTL-232	RS232C cable, approx. 2M
	GTL-258	An approximately 2M in length GPIB Cable including 25 pins Micro-D connector
	ASR-001	Air inlet filter
	ASR-002	External Three Phase Control Unit



Declaration

For the device produced after April 2022, the RS-232 interface will be changed to a standard interface. Please confirm the actual status of supplied products by contacting the business windows of each district.



Appearance

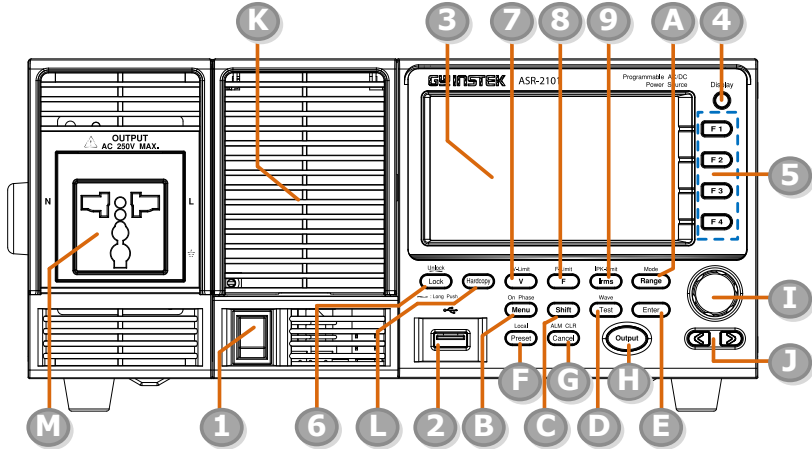



Front Panel

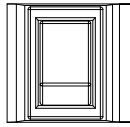
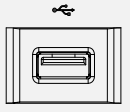



Item Index	Description
1	Power switch button
2	USB interface connector (A Type)
3	LCD screen
4	Display mode select key
5	Function keys (blue zone)
6	Lock/Unlock button
7	V/V-Limit button
8	F/F-Limit button
9	Irms/IPK-Limit button
A	Range key/Output mode key
B	Menu key/On phase key
C	Shift key

D	Test key/Output waveform key
E	Enter key
F	Preset key/Local mode key
G	Cancel key/ALM CLR key
H	Output key
I	Scroll wheel
J	Arrow keys
K	Air inlet
L	Hardcopy key
M	Output socket (ASR-2100/2050 only)

Item	Description
Power Switch	 Turn on the mains power
USB A Port	 The USB port is used for data transfers and upgrading software. Also, it is available for screenshot hardcopy in association with the Hardcopy key.
 Note	It supports FAT32 format with maximum 32G storage only.
LCD Screen	Displays the setting and measured values or menu system
Display Mode Select Key	 Selects between standard, simple and harmonic analysis mode



Function Keys  Assigned to the functions displayed on the right side of the screen





Lock/Unlock Key  Used to lock or unlock the front panel keys except output key. Simply press to lock, whilst long press to unlock.
 : Long Push



Shift Key  Turns on the shift state, which enables shortcut operations with an icon **Shift** indicated on the top status bar. The shift state, which allows continuous shortcut operations, is kept until another press on shift key again.

















 **Note** When performing shortcut operations, press shift key followed by another shortcut function key. Do Not press both shift key and shortcut function key simultaneously.

V  Used for setting the output voltage

V-Limit  +  Used for setting the output voltage limit value

F  Used for setting the output frequency (DC mode N/A)

F-Limit  +  Used for setting the output frequency limit value (DC mode N/A)

Irms		Used for setting the maximum output current
IPK-Limit	 + 	Used to set the peak output current limit value
Range Key		Switches between the 100V, 200V and AUTO ranges
Output Mode	 + 	Selects between the AC+DC-INT, AC-INT, DC-INT, AC+DC-EXT, AC-EXT, AC+DC-ADD, AC-ADD, AC+DC-Sync and AC-Sync modes
Menu Key		Enters the Main menu or goes back to one of the display modes.
On Phase	 + 	Sets the on phase for the output voltage
Test Key		Puts the instrument into the Sequence and Simulation control mode.
Output Waveform	 + 	Selects between the Sine, Square, Triangle and ARB 1~16 waveforms (not available for DC-INT, AC+DC-EXT and AC-EXT)
Enter Key		Confirms selections and settings
Preset Key		Puts the instrument into Preset mode
Local Mode	 + 	Switches operation back to local mode from remote mode

Cancel Key  Used to cancel function setting menus or dialogs.

ALM CLR  +  Clears alarms

Hardcopy Key  Used to take a screenshot by simply one press on the key. Make sure an USB flash disk is well inserted before the action.

Output Key  Turns the output on or off.

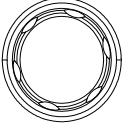
Scroll Wheel  Used to navigate menu items or for increment/decrement values one step at a time.

Arrow Keys  The arrow keys are used to select the digit power of a value that is being edited

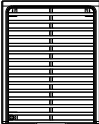
Air Inlet  Air inlet for cooling the inside of the ASR-2000 series

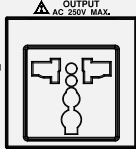
Output Socket  Output voltage socket, which has 2 versions in accordance with different regions: Universal and European types, in front panel. (only available for ASR-2100/2050)

Rear Panel

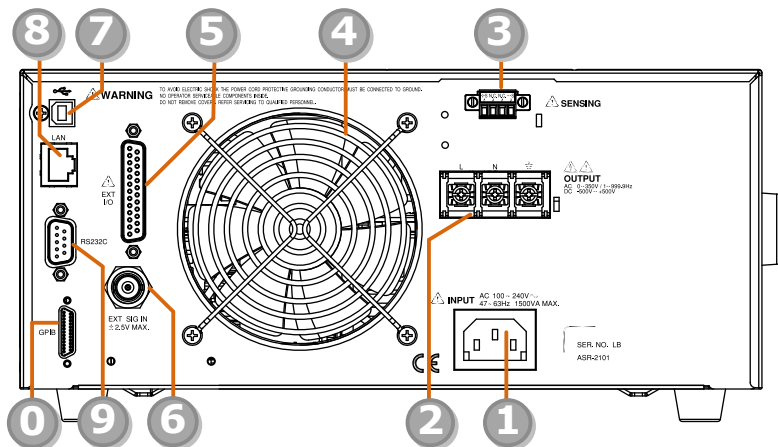

Item Index	Description
1	Line input
2	Output terminal
3	Remote sensing input terminal
4	Exhaust fan
5	External I/O connector
6	External signal input/ External synchronized signal input
7	USB interface connector (B Type)
8	Ethernet (LAN) connector
9	RS232C connector
0	ASR-GPIB-2K interface (GPIB connector)

Item	Description
------	-------------

Line Input

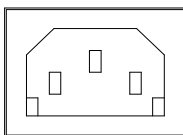

AC inlet

Output Terminal

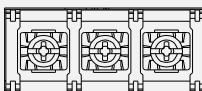

Output voltage terminal (M3 screw type, 10 ~ 18 AWG)

Remote Sensing Input Terminal



Compensation of load wire voltage drop. Only +S and -S are available for compensation. N.C. terminals are N/A. Refer to page 104 for details.

Exhaust Fan

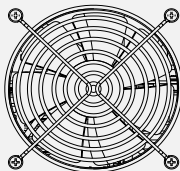

The exhaust fan is used to expel the heat from the unit. Please ensure there is at least 20 cm distance between any object and the fan.

External Control I/O Connector

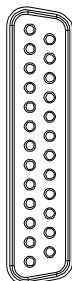

Used to control ASR-2000 externally by using the logic signal and monitor Sequence function status

External Signal
Input Connector



Synchronizing the output frequency with this external input signal for SYNC or outputting the amplified external signal with this external input signal for EXT and ADD.

USB

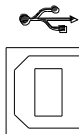

USB port for controlling the ASR-2000 remotely

Ethernet Port

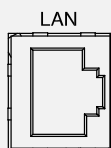

The Ethernet port is used for remote control

RS232C
Connector

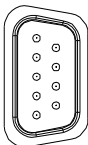

The RS232C connector for controlling the ASR-2000 remotely

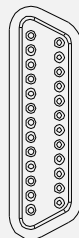

GPIB Connector
(25 pins Micro-D)



The optional GPIB connector for controlling the ASR-2000 remotely (Factory Installed ASR-GPIB-2K)

Status Bar Icons



- OFF** / **ON** Indicates if the output is ON or OFF.
- 100%** Indicates the output power as a percentage of full scale.
- 100V** Indicates if the output range is 100V, 200V or AUTO.
- SIN** Indicates if the output waveform is Sine, Square, Triangle or ARB 1 - 16.
- ALM** The alarm icon will appear on the status bar when one of the protection functions is tripped.
- Shift** Indicates the shift key is pressed which enables shortcut operations with each key.
- RMT** Indicates that the ASR-2000 is under remote mode.
- SENS** Indicates that the Remote Sense function is active.
-  Indicates that a USB flash drive is detected in the front panel host port.
- LAN** Indicates that the LAN interface is activated.
-  Indicates that the front panel lock is active.

Theory of Operation

The theory of operation chapter describes the basic principles of operation, protection modes and important considerations that must be taken into account before use.

Description of ASR-2000 System

System block are composed of the parts described below.

- **Input EMI Filter and PFC Circuit** A two stage π filter and a passive PFC circuit that convert AC power to DC power.
- **Auxiliary Power** It converts AC power line input to +24Vdc power for the PWM ICs, fan, among other devices.
- **Isolation DC to DC Converter** The isolation DC to DC converter is able to convert high DC level to lower that not only offers inverter a stable DC source but separates primary and secondary side efficiently.
- **Output Power Stage (inverter)** Two inverter power stages are in parallel or in series that provide, in addition to AC and DC output, sinusoid, square as well as triangle output waveforms.
- **Digital Processor and Close Loop Control Circuit** Composition of the C2000 DSP device and the closed-loop control circuit that execute inverter action, output measurement and all of the relevant protection functions.
- **Communication Interface and Data Transmission** DSP, FPGA and LCD controller that are collectively responsible for interface communication, data transmission, LED panel control as well as remote control.
- **Keypad and Display** CPLD that controls keys action and communicates with DSP for data transmission.

Glossary

Rate Output Maximum Power Capacity	<p>The maximum value of the output power capacity will be provided consecutively when the following situations exist:</p> <p>Output voltage is 100 to 175 V within the 100 V range.</p> <p>Output voltage is 200 to 350 V within the 200 V range.</p> <p>Output frequency is 40 to 999.9 Hz in AC mode.</p> <p>Output frequency is 1 to 999.9 Hz in AC+DC mode.</p> <p>Output voltage is 100 to 250 V within the 100 V range in DC mode.</p> <p>Output voltage is 200 to 500 V within the 200 V range in DC mode.</p>
Rate Maximum Current	<p>The maximum value of the output current (rms value) will be provided consecutively when the following situations exist:</p> <p>Output voltage is 100 V within the 100 V range.</p> <p>Output voltage is 200 V within the 200 V range.</p> <p>Output frequency is 40 to 999.9 Hz in AC mode.</p> <p>Output frequency is 1 to 999.9 Hz in AC+DC mode.</p> <p>Output voltage is 100 V within the 100 V range in DC mode.</p> <p>Output voltage is 200 V within the 200 V range in DC mode.</p>



The maximum capacity and current in DC mode is equal to AC+ DC and AC mode.

Equation:

$$\text{Rated Max. current} = \frac{\text{Rate power capacity(VA,W)}}{\text{Output voltage}}$$

Maximum Peak Current (AC-INT mode only)

The maximum value of the output current (peak value) will be provided consecutively to a capacitor input-type rectifying load when the following situations exist:

Output voltage is 100 to 175 V within the 100 V range.

Output voltage is 200 to 350 V within the 200 V range.

Output frequency is 40 to 999.9 Hz in AC mode, and 1 to 999.9 Hz in AC+DC mode.



Note

Rated maximum current (rms value) x 4 is equal to maximum peak current

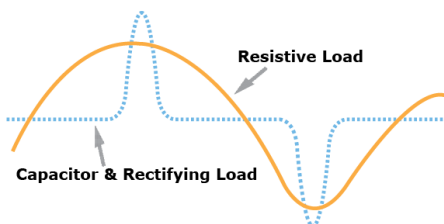

Power Factor (PF)

The power factor, which stands for a ratio of the active power correlated to the apparent power, indicates degradation level within efficiency that results from the phase difference between AC current and AC voltage.

Equation:

$$\text{Power factor} = \frac{\text{Active Power}}{\text{Apparent Power}}$$

Crest Factor (CF) The crest factor stands for a ratio of the rms value correlated to the peak value (crest value) of the waveform.

Equation:

$$\text{Crest factor} = \frac{\text{Peak value}}{\text{RMS value}}$$



Note

The crest factor is 1.41 of sine wave.

Inrush Current Capacity

It indicates the current, which is able to be supplied to a load, exceeds the rating for a short period and the duration.

Output Power Ratio

It indicates the output power of a percentage where the rated maximum output power is 100%.

Alarms

The ASR-2000 series have a number of protection features. When one of the protection alarms is tripped, the ALM icon on the display will be lit and the type of alarm that has been tripped will be shown on the display. When an alarm has been tripped the output will be automatically turned off. For details on how to clear an alarm or to set the protection modes, please see page 210.

Abnormal Output This alarm is activated and output will be disabled immediately when output overvoltage or overcurrent is detected.

Abnormal Power Source Block This alarm is activated and output will be disabled immediately when internal power source abnormality is detected. Beware that all operations will be disabled except for the power shutdown operation if an error occurs.

Abnormal Internal Control	This alarm is activated and output will be disabled immediately when internal control abnormality is detected. Beware that all operations will be disabled except for the power shutdown operation if an error occurs.
V-Limit	Voltage limit protection prevents a high voltage from damaging the DUT. This alarm can be set by the user.
F-Limit	Frequency limit protection prevents a high frequency from damaging the DUT. This alarm can be set by the user.
OCP	Over current protection prevents high current from damaging the DUT. This alarm can be set by the user.
OTP	Over temperature protection for power stage board. OTP is a hardware protection function. Only when the unit has cooled can the over temperature protection alarms be cleared.
OPP	Over Power protection for power stage board. OPP is a software protection function that is corresponded with VA value. When the unit has loaded less then protection point that the alarm be cleared.
Remote Sense Error	Sense alarm. This alarm will detect if the sense wires have been connected to the wrong polarity.
Power Input Anomaly	AC input failure. This alarm function is activated when a low AC input is detected.
FAN Fail	Fan failure. This alarm function is activated when the fan RPMs drop to an abnormally low level.

Considerations

The following situations should be taken into consideration when using the power supply.

Inrush Current When the power supply switch is first turned on, an inrush current is generated. Ensure there is enough power available for the power supply when first turned on, especially if a number of units are turned on at the same time.

Capacitive Load When the power supply connects to a capacitive load, e.g., capacitor, the load is being charged consecutively and the larger the voltage change, the more the current grow. Also, the overshoot will be possibly generated within the currents output, therefore leading to output turned off thanks to overcurrent protection from the power supply.

It is suggested to lower down the set voltage output from power supply so that the voltage of capacitive load decreases per certain unit time. In addition, a block diode is necessary to keep current from flowing back to the output terminal of power supply. Refer to the figure below where a block diode connects with the capacitive load in series to efficiently prevent current from flowing back to the power supply.

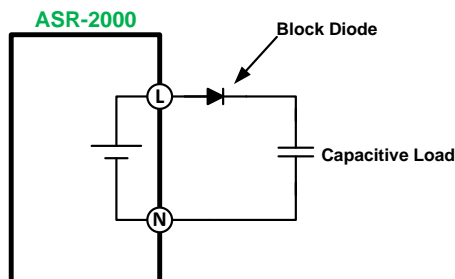

Inductive Load When the power supply connects to an inductive load, e.g., inductor, which generates a back EMF (Electromotive Force) when output current is accidentally turned off, a backflow diode is necessary for absorbing the back EMF, which may cause irreversible damage to the power supply. Refer to the following figure where a backflow diode connects with the inductive load in parallel to effectively absorb the possible back EMF.

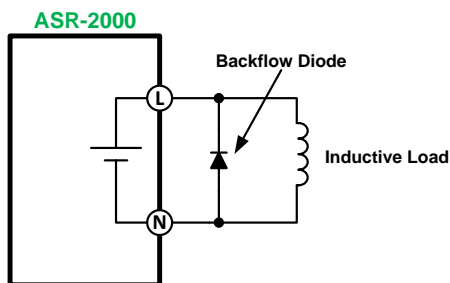

 **CAUTION**

Ensure the connected diode meets the following specifications between the load, either capacitor or inductor, and the ASR-2000 series power supplies.

- ✓ Maximum reverse voltage: 600 V or higher
- ✓ Maximum forward current: 15 A or more for 100V range, and 7.5 A or more for 200V range

Grounding

The output terminals of the ASR-2000 series are isolated with respect to the protective grounding terminal. The insulation capacity of the load, the load cables and other connected devices must be taken into consideration when connected to the protective ground or when floating.

Grounded Neutral Output Basically, grounded return on the neutral output is allowed for ASR-2000 series and electric shock may occur if not following the grounding procedure based on the local electrical safety codes. In some cases, 0 V is specifically required between ground and neutral, which can substantially moderate ground loops, thus keeping sensitive equipment from effects of ground loops and reducing ground noise.

Ground & Neutral Shortcut Illustration

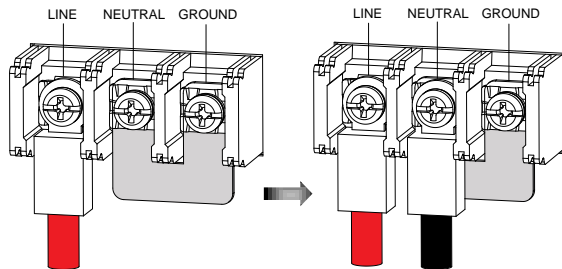

Owing to the fact that the neutral has been shortcut with the ground which is referenced to the chassis ground, few electric shocks may still take place from time to time, for which we sincerely ask your additional attention.

OPERATION

Set Up	34
Power Up.....	34
How to Use the Instrument.....	34
Output Terminals.....	37
Installing GET-003/GET-004 Box Series (ASR-2000R only)	41
Using the Rack Mount Kit	44
Edit Arbitrary Waveform	46
Reset to Factory Default Settings.....	50
View Firmware Version and Serial Number	51
USB Driver Installation	52
Filter Installation	54
Wire Gauge Considerations	56
Menu Tree	58
Main Page.....	59
Function Keys.....	60
AC+DC-INT, AC+DC-EXT, AC-EXT, AC+DC- ADD, AC-ADD, AC-VCA	60
AC-INT	60
DC-INT.....	61
AC+DC-Sync, AC-Sync	61
Menu	62
Basic Operation	63
Select the Output Mode.....	64
Select the Voltage Range.....	66
Select the Output Waveform	67
Setting the Frequency Limit.....	76
Setting the Output Frequency & Signal	79
Setting the Peak Current Limit	81
Setting the Output Current Level	83
Setting the Output On Phase.....	85
Setting the Output Off Phase	87
Setting the Sync Phase.....	89
Switch the Display Modes	92
Using the Measurement Function.....	95
Switch the Measurement Format	98
Panel Lock.....	100

Alarm Clear	101
Turning the Output On/Off	102
Advanced Settings	103
Using the Remote Sense Function.....	103
Local Sense	103
Remote Sense	104
Preset Settings.....	106
Save Preset Settings to Local Memory.....	106
Load Preset Settings to Local Memory.....	107
Manage Preset Settings	108
External Keypad Operation	111
USB Keypad	111

Set Up

Power Up

Steps

1. Connect the power cord to the rear panel socket.

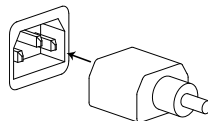

2. Press the *POWER* key. The splash screen will appear momentarily before the continuous mode screen appears with the settings loaded.

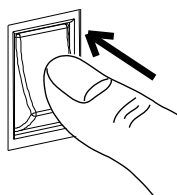

CAUTION

The power supply takes around 15 seconds to fully turn on and shutdown.

Do not turn the power on and off quickly.

How to Use the Instrument

Background

The ASR-2000 AC power supplies generally use the *scroll wheel*, *Arrow* keys and *Enter* keys to edit numerical values or to select menu options.

Menu navigation is performed using the menu keys and function keys on the front panel.

The following section will explain some of these concepts in detail.

Selecting Menu Items

1. Turn the scroll wheel to select parameters in menus and lists. The selected parameter will be highlighted in orange. The scroll wheel is also used to increment/decrement setting values.

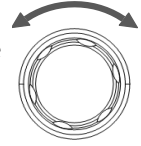

2. Press the *Enter* key to edit the parameter or to enter the selected menu.



Example

The following is an example of the menu list that appears when the Menu key is pressed.

Selected parameter

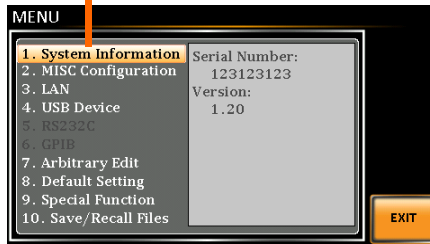

Using the Arrow Keys and Scroll Wheel to Edit Parameter Values

Use the *Arrow* keys to select a digit power and then use the scroll wheel to edit the value by that power.

1. Use the *Arrow* keys to move the cursor to the digit of the desired value.



2. Turn the scroll wheel to edit the value by the resolution of the selected digit.

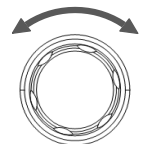

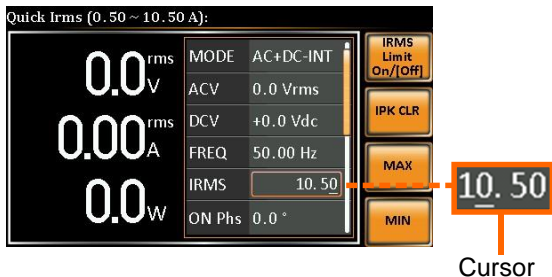

3. Repeat the steps above for all the relevant digits.
4. Press the *Enter* key to confirm the edit.



Note

By default the cursor starts at the lowest digit of value.

Using the Function Keys

The function keys are quick settings keys, the function of which depends on the current menu or operation.

1. Press the *Function* key that corresponds to the setting directly to its left side.
2. The setting or parameter is immediately executed.

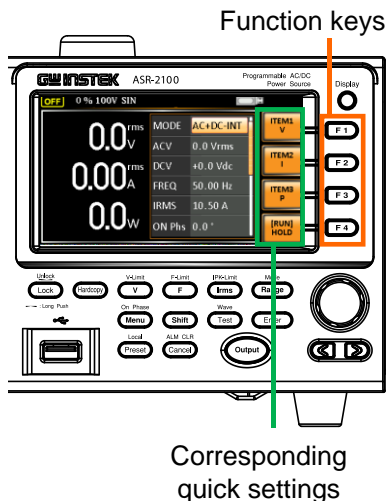

3. Repeat the steps above for all the relevant digits.

Output Terminals

Background The output terminals can be output from either the front panel or from the rear panel. The outputs are limited to 5 A / 2.5 A (ASR-2050), 10 A / 5 A (ASR-2100).

Supported Plugs Multi-region terminal socket
 Supported standards
 IEC, North America, Japan.
 EURO CEE type universal plug

! WARNING Dangerous voltages. Ensure that the power to the instrument is disabled before handling the power supply output terminals. Failing to do so may lead to electric shock.



CAUTION

For the front panel output, the maximum output voltage is 250 VAC and current is 10 A.

Front Panel Output Connection

1. The front panel has a multi-region power socket depending on the socket type.
2. Insert the plug from the DUT into the socket.

(ASR-2000 or ASR-2000R w/t GET Series Box)

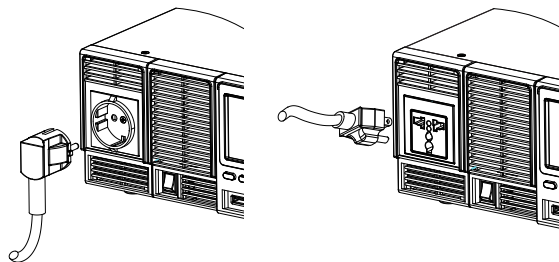

EURO CEE socket

IEC North America, Japan



WARNING

Dangerous voltages. Ensure output is off before unplugging the plug from the front panel socket.



WARNING

Except for the AC-INT, AC-EXT and AC-Sync modes, the terminal outputs DC voltage as well.

3. Turn the power on. The AC power supply is now ready to power the DUT.

Rear Panel Output Connection The rear panel output is used to supply higher power DUTs.

1. Disconnect the unit from the mains power socket and turn the power switch off.

2. Remove the protective lid from the output terminals by loosening the screw.

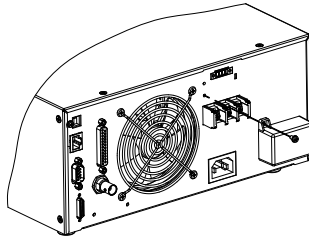

3. Connect the output AC power wires to the AC output terminals.
 - Red → Line (L)
 - Black → Neutral (N)
 - Green → GND (⏏)

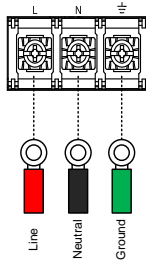

4. Cover the protective lid onto the output terminals as the figure below shown.

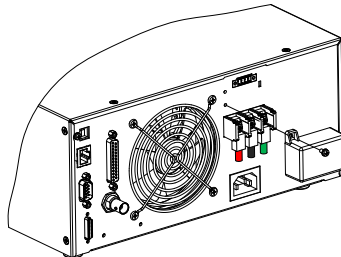

5. Fasten the screw of protective lid with the unit.

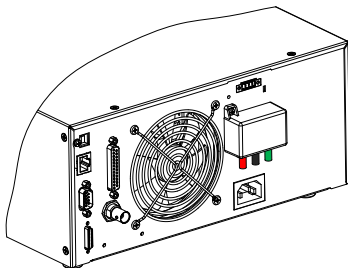

6. Turn the power on. The AC power supply is now ready to power the DUT.



Note

Grounded Neutral Output:
ASR-2000 allows for a grounded return on the neutral output. It is suit for the medical industry that required between ground with neutral is 0 V essentially. And possible to mitigate ground loops that is ideal for reduce ground noise and isolate sensitive equipment from the effects of ground loops.



WARNING

Because the neutral has been referenced to the chassis ground, be careful electric shock by yourself.

Installing GET-003/GET-004 Box Series (ASR-2000R only)

Background There are optional box series which are applicable to the ASR-2050R and ASR-2100R for additional power output socket in the front panel.

Optional Modules GET-003 Universal Socket
GET-004 European Socket



WARNING

Dangerous voltages. Ensure that the power to the instrument is disabled before handling the GET-003/004 installation. Failing to do so may lead to electric shock.

Installation

1. Turn off the power switch followed by removing the power cord from the unit.

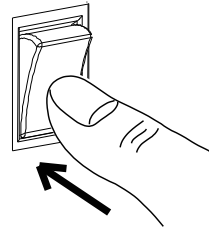

2. First check the 2 hooks embedded within the internal side of the GET-003/004 series.

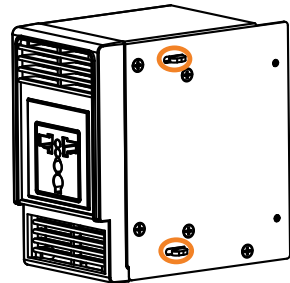

3. Align the 2 hooks of GET-003/004 with the 2 rectangular grooves on the flank of ASR-2000R unit and slide GET-003/004 horizontally.

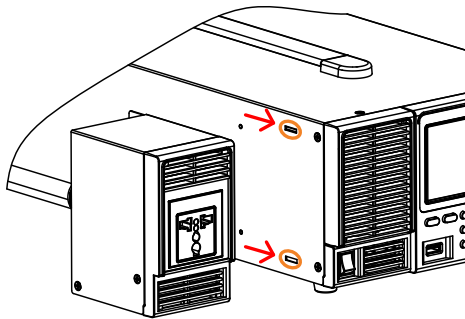

4. Gently slide the GET-003/004 into place until click to have it level with ASR-2000R evenly.

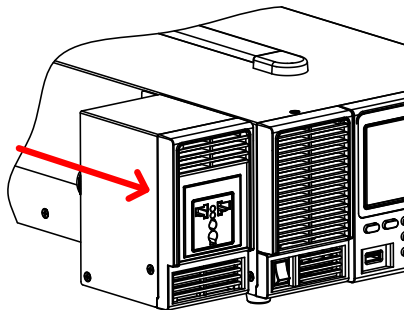

5. Fasten the 2 screws in the rear side of GET-003/004 with bare hands easily.

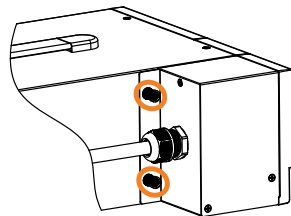

6. Connect the output AC power wires from the GET-003/004 to the AC output terminals.
 - Red → Line (L)
 - Black → Neutral (N)
 - White → GND (\perp)

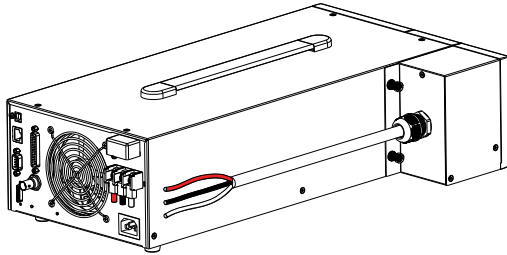

7. Cover the protective lid back to the output terminals followed by fastening the screw of protective lid with the unit.

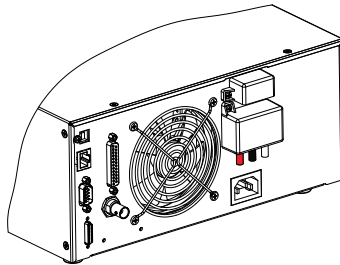

8. GET-003/GET-004 is well assembled with the ASR-2000R unit.

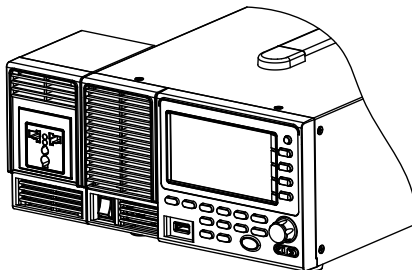

Using the Rack Mount Kit

Background The ASR-2000 and ASR-2000R have the following optional Rack Mount kits, respectively.

Unit Model	Rack Mount kit part number
ASR-2000	GRA-439-E
ASR-2000R	
ASR-2000	GRA-439-J
ASR-2000R	

The GRA-439-E is designed to fit into an EIA rack of 3U-height, while the GRA-439-J is designed to fit into a JIS rack of 3U-height. Please see your distributor for further rack mount details.

GRA-439-E Series

GRA-439-E Rack Mount Diagram (ASR-2000)

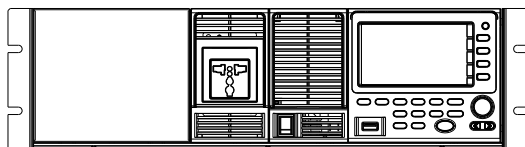

GRA-439-E Rack Mount Diagram (ASR-2000R)



GRA-439-E Rack Mount Diagram (Dual ASR-2000Rs)

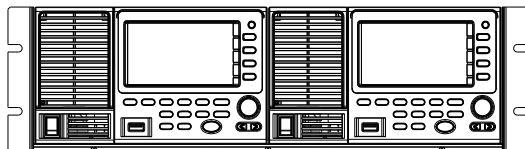

GRA-439-J Series

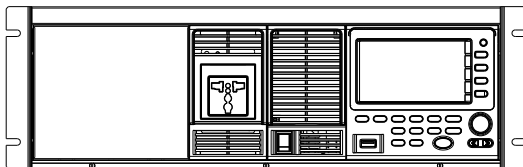
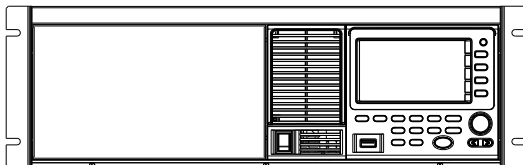
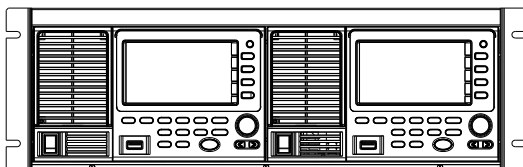
GRA-439-J Rack
Mount Diagram
(ASR-2000)GRA-439-J Rack
Mount Diagram
(ASR-2000R)GRA-439-J Rack
Mount Diagram
(Dual ASR-2000Rs)**CAUTION**

Ensure adequate ventilation is provided when using the rack mount. Ensure that a gap is given for air intakes. Failure to do so may cause the instrument to overheat.

Edit Arbitrary Waveform

Background The arbitrary waveform editing function is to select built-in arbitrary waveforms. There are a number of built-in waveform shapes to choose from, each of which can be customized with varied attributes. Finally, choose an ARB NO. (1~16) to output the selected built-in waveform.

- Steps**
1. Press the *Menu* key. The Menu setting will appear on the display. 
 2. Use the scroll wheel to go to item 7, *Arbitrary Edit* and press *Enter* to enter the Arbitrary Edit page.

Built-in Waveform	TRI, STAIR, CLIP, CF-1, CF-2, SURGE, DST01-22
-------------------	---

3. Use the scroll wheel and *Enter* key to select waveform along with pertaining attributes and press *Save* to confirm settings.

Setting Screen Overview

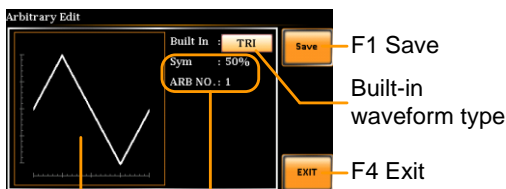

Visual representation of the waveform shape and its attributes

Attributes for the selected waveform and its attributes

ARB Waveform Overview

The following describes each of the built-in waveforms.

TRI The triangle waveform has a settable number of percentage.

Attributes:

Sym: 0 ~ 100%

ARB NO: 1 ~ 16

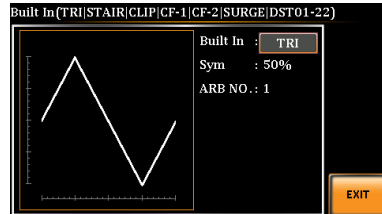

STAIR The staircase waveform has a settable number of step levels.

Attributes:

Stairs: 1 ~ 100

ARB NO: 1 ~ 16

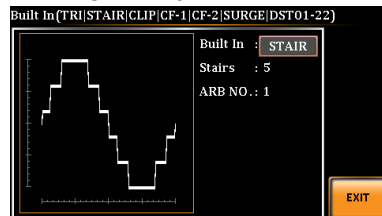

CLIP Outputs a clipped sinewave. The degree to which the sine wave is clipped is settable.

Attributes:

Ratio: 0.00 ~ 1.00

ARB NO: 1 ~ 16

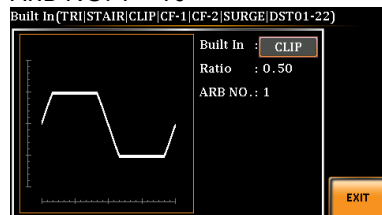

CF-1 Crest factor (CF-1) waveform. The crest factor is settable.

Attributes:

CF: 1.1 ~ 10.0

ARB NO: 1 ~ 16

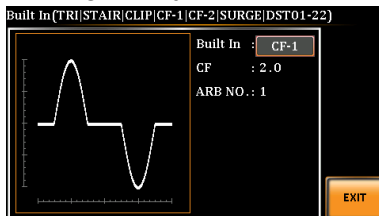

CF-2 Crest factor (CF-2) waveform. The crest factor is settable.

Attributes:

CF: 1.5 ~ 2.0

ARB NO: 1 ~ 16

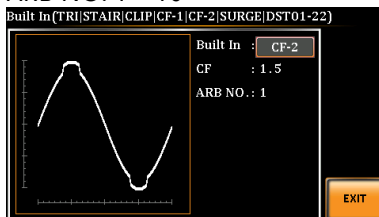

SURGE The surge waveform has a settable ACV base level, site size and site shape.

Attributes:

Type: SQU, SIN (site waveform type)

ACV: 0 ~ 100% (base waveform ampl.)

Site: 0 ~ 100% (site waveform width)

ARB NO: 1 ~ 16

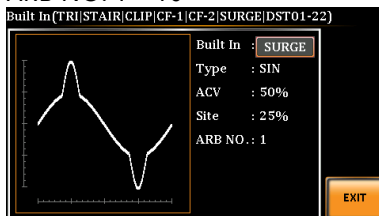

DST01-22 The DST01-22 waveform shape function simply adds a number Fourier series terms to create an arbitrary waveform.

Attributes:

Type: 1 ~ 22 (Number of selectable ARB waveforms)

ARB NO: 1 ~ 16

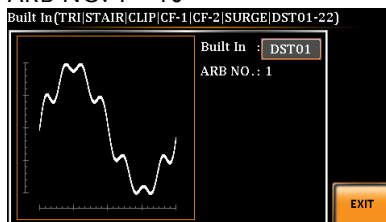

RIPPLE The RIPPLE waveform shape function has a settable DC ripple attributes.

Attributes:

Times: 1/2/3/6

VDC: 1~100

Level: 1%~30%

ARB NO: 1 ~ 16

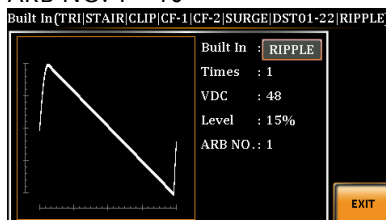

Save

4. Press *Save*[F1] to save the Arbitrary Edit settings.



Exit

5. Press *Exit*[F4] to exit from the Arbitrary Edit settings.



Reset to Factory Default Settings

Background The default settings can be restored from the Menu key settings. See page 205 for the default factory settings.

- Steps**
1. Press the *Menu* key. The Menu settings will appear on the display. 
 2. Use the scroll wheel to go to item 8, *Default Setting*.
 3. Press *Enter* for 2 times to restore the unit back to the default settings.

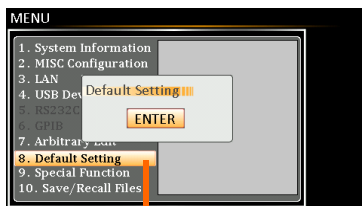



Default settings



Default Setting will Not restore back to default settings for Preset/SEQ/SIM/ARB modes.

View Firmware Version and Serial Number

Background The Menu>System Information setting displays the serial number and firmware version.

- Steps**
1. Press the *Menu* key. The Menu setting will appear on the display. 
 2. The system information should now be listed in the item 1, System Information, on the display
- Exit**
3. Press *Exit*[F4] to exit from the Menu settings. 

System Information

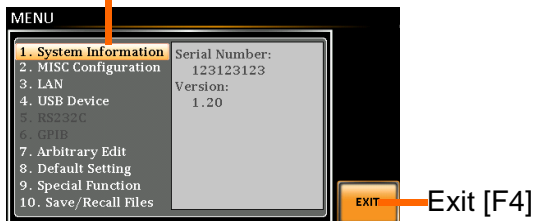

USB Driver Installation

Background If the USB Type B interface is to be used for remote control, the USB driver needs to be installed.

 **Note** The USB driver, both gw_asr.inf and gw_asr.cat can be downloaded from the GW Instek website.

For information on the USB interface, see page 184.

- Steps**
1. Connect the rear panel USB -B port on the ASR-2000 to the PC using a USB Type A to B cable.
 2. Go the Windows Device Manager.

For Windows 7:

Start > Control Panel > Hardware and Sound > Device Manager

 **Note**

It is available for Windows 7 and Windows 10.

3. The ASR-2000 will be located under *Other Devices* in the hardware tree. Right-click the *ASR-2XXX* and choose *Update Driver Software*.

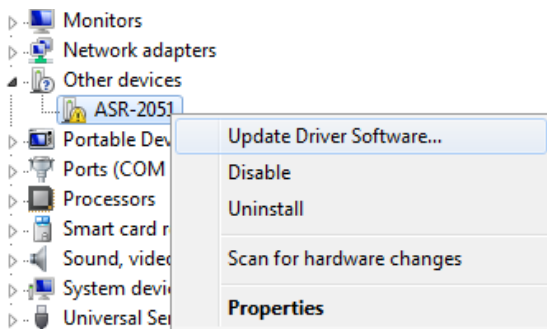

- From the hardware wizard choose *Browse my computer driver software*.

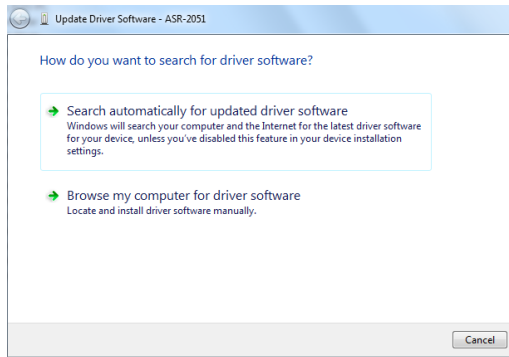

- Set the file path to the location of the USB driver, click Next and finish the driver installation.

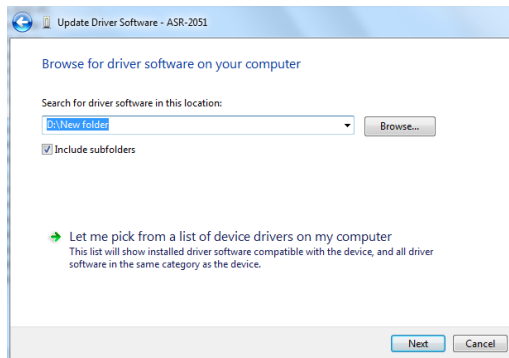

- ASR-2000 will now be located in the *Ports* node of the hardware tree in the Windows Device Manager if the driver installation was successful.

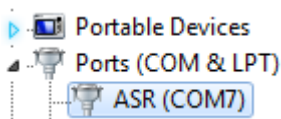

Filter Installation

Background The ASR-2000 has a filter (GW Instek part number, ASR-001) that must first be inserted under the control panel before operation.

- Steps**
1. Loosen the screw embedded beneath the air inlet as indicated within the figure below.

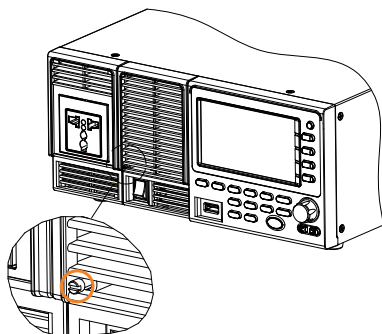

2. Pull the frame of air inlet outward from the bottom side to detach it from unit.

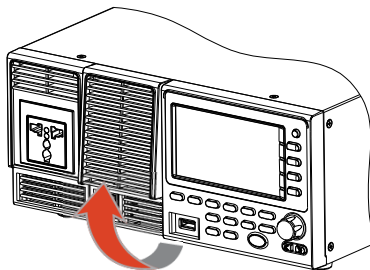

3. Remove the frame of air inlet followed by gently putting it aside.

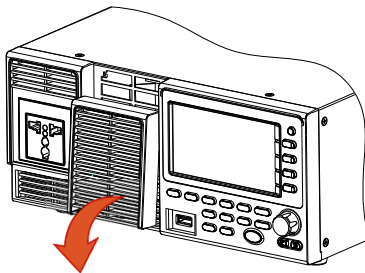

4. The air filter is positioned in the rear side of frame of air inlet. Simply rinse it or replace the filter with a new one based on the actual status.

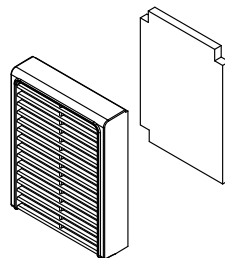

5. Repeat the previous steps conversely to reinstall the air inlet with new filter back to unit.
6. The unit is now ready to power up.



Note

Please clean regularly to avoid damaging the internal components of the machine.



WARNING

The procedure above should only be attempted by competent persons.

Ensure the AC power cord is not connected to power before operation.

Wire Gauge Considerations

Background Before connecting the output terminals to a load, the wire gauge of the cables should be considered.

It is essential that the current capacity of the load cables is adequate. The rating of the cables must equal or exceed the maximum current rated output of the instrument.

Recommended Wire Gauge	Wire Gauge	Nominal Cross Section	Maximum Current
	20	0.5	9
	18	0.75	11
	18	1	13
	16	1.5	18
	14	2.5	24
	12	4	34
	10	6	45
	8	10	64
	6	16	88
	4	25	120
	2	32	145
	1	50	190
	00	70	240
	000	95	290
	0000	120	340

The maximum temperature rise can only be 60 degrees above the ambient temperature. The ambient temperature must be less than 30 degrees.

To minimize noise pickup or radiation, the load wires and remote sense wires should be twisted-pairs of the shortest possible length. Shielding of the sense leads may be necessary in high noise environments. Where shielding is used, connect the shield to the chassis via the rear panel ground screw. Even if noise is not a concern, the load and remote sense wires should be twisted-pairs to reduce coupling, which might impact the stability of the power supply. The sense leads should be separated from the power leads.

Menu Tree

Convention Use the menu trees as a handy reference for the power supply functions and properties. The ASR-2050 / ASR-2050R / ASR-2100 / ASR-2100R menu system is arranged in a hierarchical tree. Each hierarchical level, which is coated in varied colors, can be navigated through the orders within the diagrams below.

For example: To set the interface to Buzzer OFF;

- ① Press the *Menu* key.
- ② Navigate to the MISC Configuration option.
- ③ Enter the Buzzer option.
- ④ Select OFF.

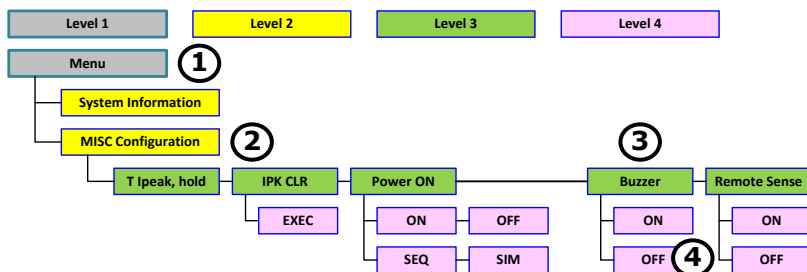

Main Page

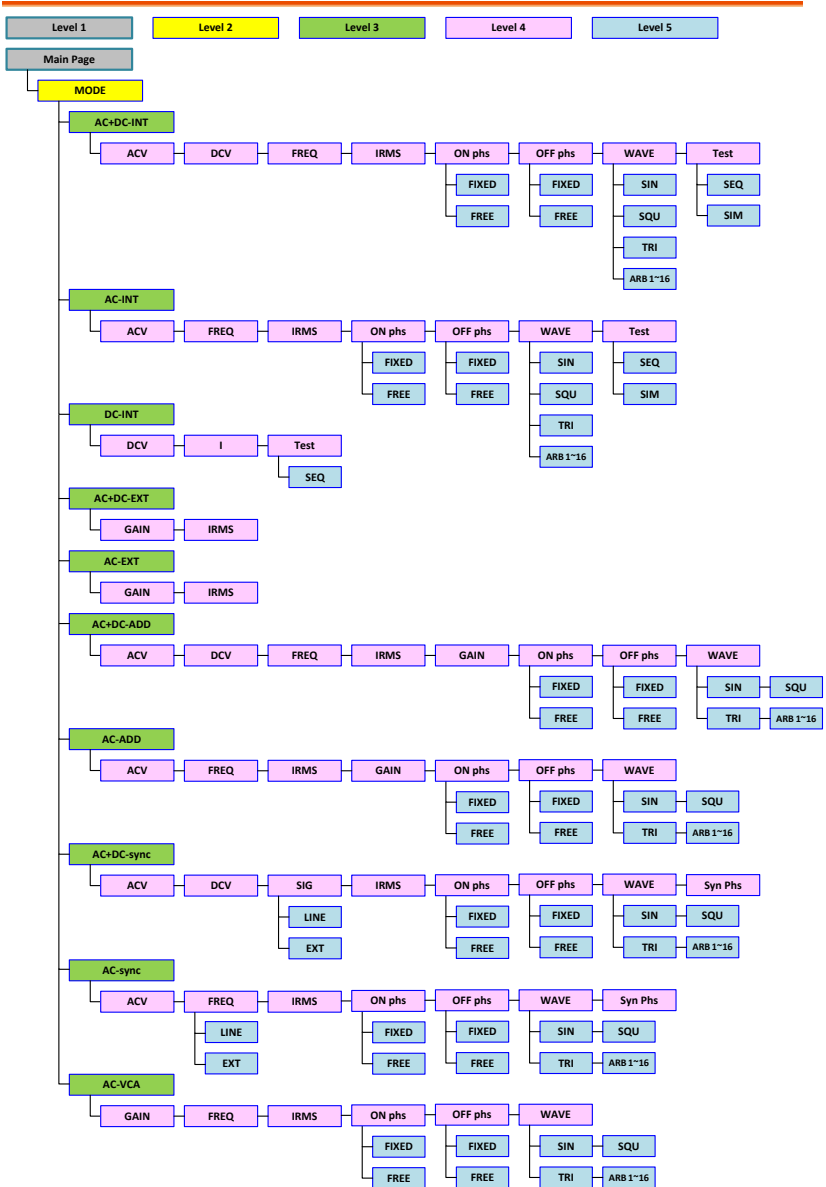

Function Keys

AC+DC-INT, AC+DC-EXT, AC-EXT, AC+DC-ADD, AC-ADD, AC-VCA

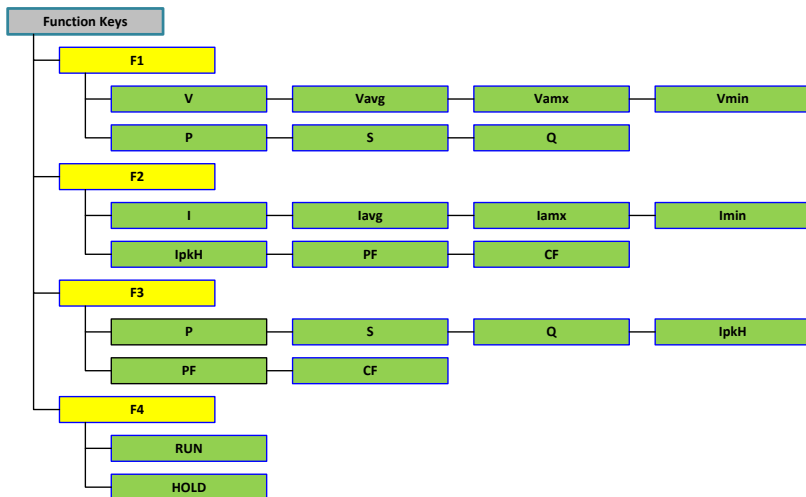

AC-INT

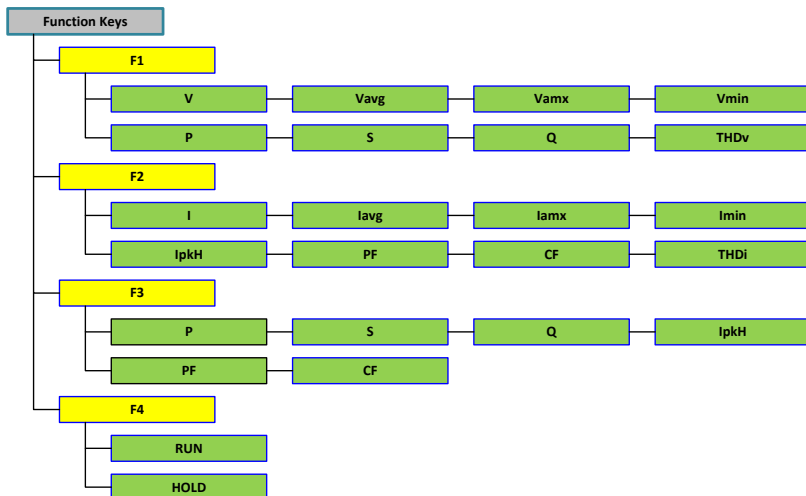

DC-INT

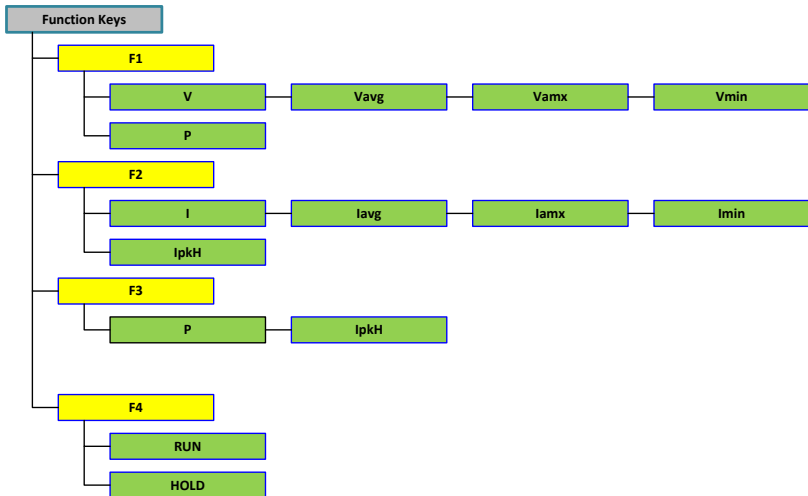

AC+DC-Sync, AC-Sync

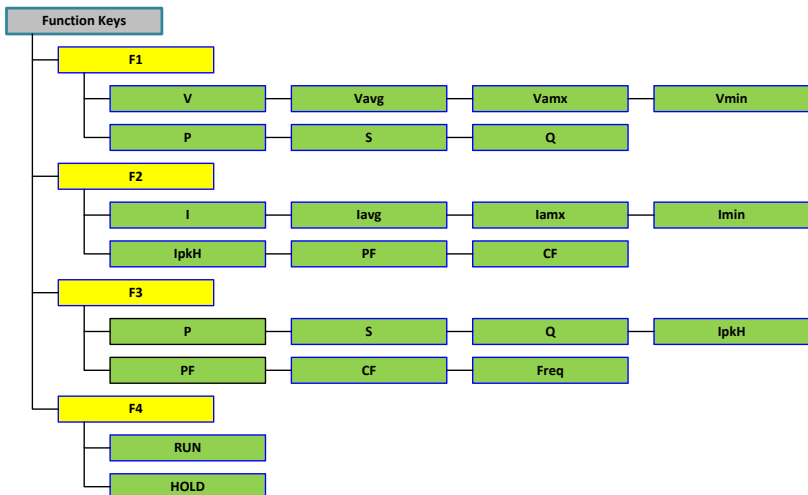

Menu

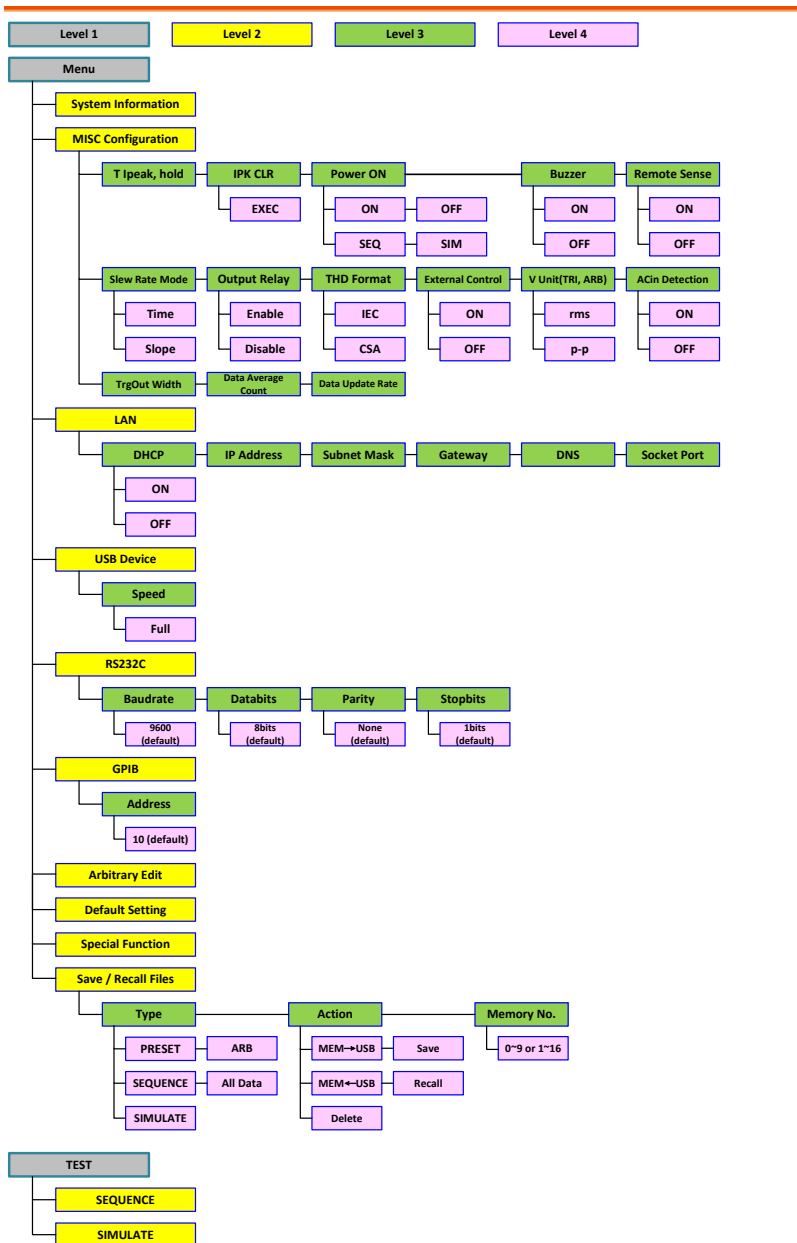

Basic Operation

This section describes the basic operations required to operate the power supply.

- Select the Output Mode → from page 64
- Select the Voltage Range → from page 66
- Select the Output Waveform → from page 67
- Setting the Output Voltage Limit → from page 70
- Setting the Output AC/DC Voltage & Gain → from page 73
- Setting the Frequency Limit → from page 76
- Setting the Output Frequency & Signal → from page 79
- Setting the Peak Current Limit → from page 81
- Setting the Output Current Level → from page 83
- Setting the Output On Phase → page 85
- Setting the Output Off Phase → page 87
- Switch the Display Modes → from page 87
- Using the Measurement Function → from page 95
- Switch the Measurement Format → from page 98
- Panel Lock → from page 100
- Alarm Clear → from page 101
- Turning the Output On/Off → from page 102

Before operating the power supply, please see the Getting Started chapter, page 9.

Select the Output Mode

Background The ASR-2000 has up to 9 modes to output, which empower user to have multiple applications for different scenarios.

Steps

1. Press *Shift + Range* to access the MODE selection menu.
 

Alternatively, it is available to use scroll wheel followed by the Enter key to enter the MODE menu.

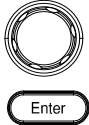

2. Choose an output mode with scroll wheel.

Mode	Description
AC+DC-INT	AC & DC Internal Output
AC-INT	AC Internal Output
DC-INT	DC Internal Output
AC+DC-EXT	AC & DC External Output
AC-EXT	AC External Output
AC+DC-ADD	AC & DC Additional Output
AC-ADD	AC Additional Output
AC+DC-Sync	AC & DC Synchronal Output
AC-Sync	AC Synchronal Output
AC-VCA	AC Voltage Control Amplifier Output
INT	The signal source is from internal. Set the output voltage, waveform, frequency, on phase and off phase through the control panel or the remote control.
EXT	The signal source is from external. Amplifies and outputs the external input signal. Set the voltage gain through the control panel or the remote control.
ADD	The signals are the total of the external and internal signal source. Set the voltage gain for the external input signal, the output voltage for the internal signal source, the output waveform, frequency, on phase and off phase through the control panel or the remote control.

Sync The signal source is from internal. The output frequency is synchronized with the external TTL input signal or the power line. This frequency setting can't be set through the control panel or the remote control. All of setting conditions except for output frequency are as same as INT mode.

VCA The output voltage can be controlled with the external DC 0~2.5V input signal via BNC terminal. The output voltage setting can't be set through the panel or remote control. All conditions except for output voltage setting is same as INT mode.

3. Press *Enter* to confirm the mode selection.

Example

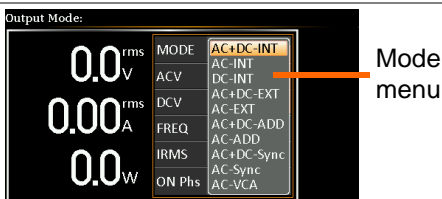

Select the Voltage Range

Background The Range setting determines the general outlet voltage range. The ranges available correspond to common mains output voltage standards.

Steps

1. Press *Range* to access the Range menu.



- Set the voltage range with the F1 ~ F4 soft-keys.

	F1: AUTO
Soft-keys	F3: 200V
	F4: 100V

- Press *Enter* to confirm the Range setting.

Example

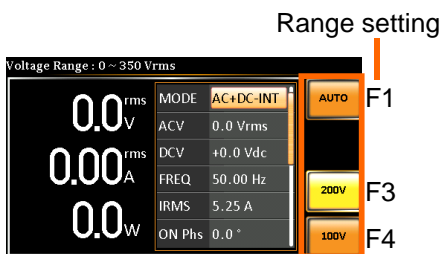

Note

The output voltage values set by user can be divided into 2 manual settings, both of which have close relation with voltage range that contains high range (200V, AUTO) and low range (100V). For instance, when setting 5 Vrms under 200V range and 3 Vrms under 100V range, the Vrms setting will change from 5 Vrms to 3 Vrms directly after switching the voltage range from 200V to 100V.

Also, if the voltage range is changed when the output is on, the output will be automatically turned off.

Select the Output Waveform

Background The ASR-2000 is capable of outputting sine, square, triangle and ARB wave shapes while connecting with external signals.

Steps

1. Press *Shift* + *Test* to access the Wave menu.



Alternatively, it is available to use scroll wheel followed by the Enter key to enter the Wave menu.



2. Choose a waveform with scroll wheel.

Mode	Description
SIN	Sine wave
SQU	Square wave
TRI	Triangle wave
ARB 1 ~ 16	Arbitrary wave 1 ~ 16

3. Press *Enter* to confirm the waveform setting.

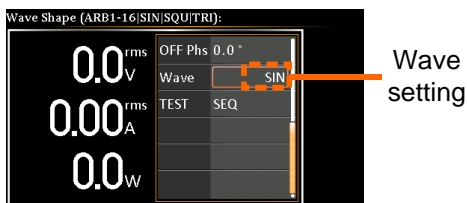

- Waveform selection is Not available under DC-INT, AC+DC-EXT and AC-EXT output modes.
- For more details about Arbitrary waveforms, refer to the page 116.
- When changing to a waveform with setting higher than the upper limit of other waveform, the setting of other waveform will be adjusted to zero forcibly. For instance, when it is originally SIN output with ACV in 150 Vrms (175 Vrms for V-Limit), the ACV will be changed to 0 Vrms (144.3 Vrms for V-Limit) after output waveform adjusts to TRI.

Setting the Output Voltage Limit

Background Setting the voltage limit allows the output voltage to be set to any level within the voltage limit range.

Steps

1. Press *Shift* + *V* to access the Volt Limit menu.

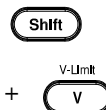

2. When it is under AC+DC-INT, DC-INT, AC+DC-ADD or AC+DC-Sync mode.

Use the scroll wheel to toggle between VPK+ (upper) and VPK- (lower) settings followed by pressing *Enter* to get into the parameter. Proceed to the step 3 for setup.

VPK+ Setting

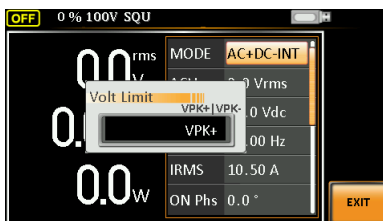

VPK- Setting

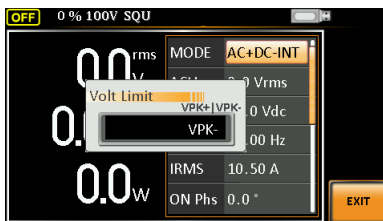

When it is under AC-INT, AC-ADD or AC-Sync mode.

Use the scroll wheel to set value of Vrms limit directly or use the F3 (MAX) and F4 (MIN) soft-keys to set the limit to the maximum or minimum value.

AC-INT, AC-ADD, AC-Sync

Vrms Range 10% ~ 100% full range voltage

Soft-keys MAX, MIN

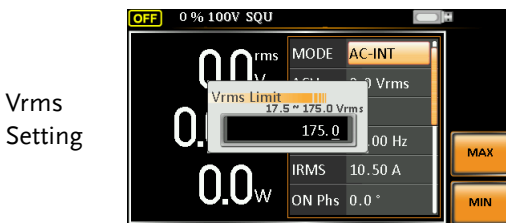

Note

The Vrms Limit value defined by user will be generally applied to AC-INT, AC-ADD and AC-Sync modes under the same voltage range, which divides into 2 levels, high range including AUTO and 200V and low range covering 100V.

3. Set the voltage limit (VPK+ & VPK-) with the scroll wheel or with the F3 (MAX) and F4 (MIN) soft-keys to set the limit to the maximum and minimum values, respectively.

AC+DC-INT, DC-INT, AC+DC-ADD, AC+DC-Sync

VPK+ Range 4% ~ 100% full range peak voltage

Soft-keys MAX, MIN

VPK- Range 4% ~ 100% full range peak voltage

Soft-keys MAX, MIN



Note

Both the VPK+ and VPK- Limit values defined by user will be generally applied to AC+DC-INT, DC-INT, AC+DC-ADD and AC+DC-Sync modes under the same voltage range, which divides into 2 levels, high range including AUTO and 200V and low range covering 100V.

4. Press *Enter* to confirm the voltage limit setting.



Note

- Voltage limit setting is Not available for both AC+DC-EXT and AC-EXT output modes.
- There 6 sets of voltage limits in total.
- The minimum voltage limit has relative connection with the voltage setting. That is, the voltage setting is never beyond the voltage limit.
- The range of voltage limit will be limited within the certain minimum value in accordance with the output voltage setting.

Setting the Output AC/DC Voltage & Gain

Background The ACV, DCV and Gain settings set the output voltage level. Before setting the power supply voltage level, set the voltage range and voltage limit beforehand.

Steps

1. Press the *V* key. The ACV parameter will be selectable.



Also, it is available to use the scroll wheel followed by the Enter key to make the ACV parameter selectable as well.



When it is under AC+DC-INT, AC+DC-ADD or AC+DC-Sync mode.

Further use the scroll wheel to navigate to the DCV parameter and press *Enter* to make DCV parameter selectable.

DCV

When it is under DC-INT mode.

Directly press the *V* key or use the scroll wheel to navigate to the DCV parameter and press *Enter* to make DCV parameter selectable.

When it is under AC+DC-EXT, AC-EXT or AC-VCA mode.

Directly press the *V* key or use the scroll wheel to navigate to the GAIN parameter and press *Enter* to make GAIN parameter selectable.

GAIN

When it is under AC-ADD mode.

Further use the scroll wheel to navigate to the GAIN parameter and press *Enter* to make GAIN parameter selectable.

2. Set ACV/DCV/GAIN value with the scroll wheel or with the F1 ~ F4 soft-keys.

AC+DC-INT, AC-INT, DC-INT

ACV	Range	0 volts ~ full range
-----	-------	----------------------

DCV	Soft-keys	DEF1, DEF2, MAX, MIN
-----	-----------	----------------------

AC+DC-EXT, AC-EXT, AC-VCA

GAIN	Range	0 times ~ full range
------	-------	----------------------

	Soft-keys	DEF1, DEF2, MAX, MIN
--	-----------	----------------------

AC+DC-ADD, AC-ADD

ACV	Range	0 volts ~ full range
-----	-------	----------------------

DCV	Soft-keys	DEF1, DEF2, MAX, MIN
-----	-----------	----------------------

GAIN	Range	0 times ~ full range
------	-------	----------------------

	Soft-keys	DEF1, DEF2, MAX, MIN
--	-----------	----------------------

AC+DC-Sync, AC-Sync

ACV	Range	0 volts ~ full range
-----	-------	----------------------

DCV	Soft-keys	DEF1, DEF2, MAX, MIN
-----	-----------	----------------------

3. Press *Enter* to confirm voltage or gain setting.

Defined Settings

The DEF1 and DEF2 settings are user-defined settings. By default they are set to 0.0 and 100.0 volts (100V range), 200.0 volts (200V and AUTO range), respectively and 100 and 200 times for gain. The MAX and MIN soft-keys set voltage or gain parameters to the maximum or minimum value, respectively.

4. Repeat the previous steps 1 ~ 2 to set AC/DC voltage and gain value with the scroll wheel.

- Press and hold either the *DEF1* or *DEF2* soft-key until “Saved to DEF1/2” is displayed, which indicates the voltage and gain settings are saved to the DEF1 or DEF2 soft-key individually.



Note

- Trying to set the voltage outside of the voltage limit/range will result in a voltage setting error being displayed on the screen.
- ACV, DCV and GAIN settings under each output mode and range have their own DEF1 and DEF2 saved values, respectively.

Example of ACV Setting in the AC+DC-INT

ACV setting Defined setting

Example of DCV Setting in the DC-INT

DCV setting Defined setting

Example of GAIN Setting in the AC+DC-EXT

GAIN setting Defined setting



Note

1. Vrms can only be set up to 144.3 Vrms / 288.6 Vrms for triangular waveform.
2. Go to Menu -> MISC -> V Unit to select the voltage set value unit.

Setting the Frequency Limit

Background

Setting the frequency limit allows the frequency output to be set to any level within the limit range.

Steps

1. Press *Shift* + *F* to access the Freq Limit menu.

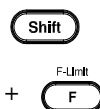

2. Use the scroll wheel to toggle between Freq Hi (upper) and Freq Lo (lower) settings followed by pressing *Enter* to get into the parameter.

Freq Hi Setting

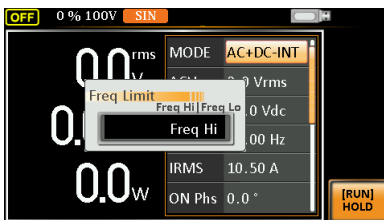

Freq Lo Setting

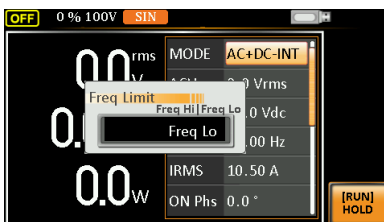

3. Set the frequency limit with the scroll wheel or with the F3 ~ F4 soft-keys. The MAX and MIN soft-keys set the frequency limit to the maximum and minimum, respectively.

AC+DC-INT, AC+DC-ADD

Freq Hi Range 1.00 ~ 999.9 Hz

Limit Soft-keys MAX, MIN

Freq Lo Range 1.00 ~ 999.9 Hz

Limit Soft-keys MAX, MIN

Freq Hi
Setting

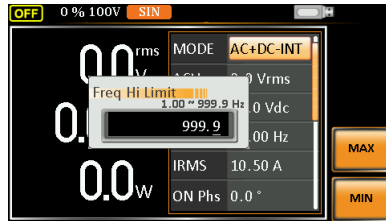

Freq Lo
Setting

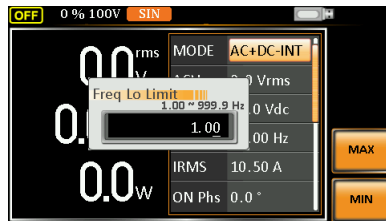

AC-INT, AC-ADD, AC-VCA

Freq Hi Range 40.00 ~ 999.9 Hz

Limit Soft-keys MAX, MIN

Freq Lo Range 40.00 ~ 999.9 Hz

Limit Soft-keys MAX, MIN

Freq Hi
Setting

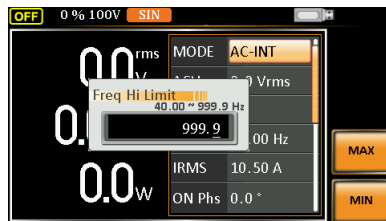

Freq Lo Setting

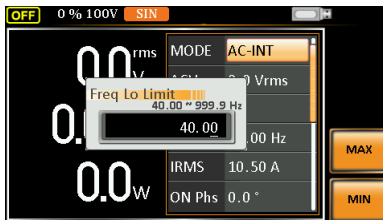

4. Press *Enter* to confirm the limit setting.

Freq Limit setting

Example of Freq Hi Limit Setting in AC+DC-INT

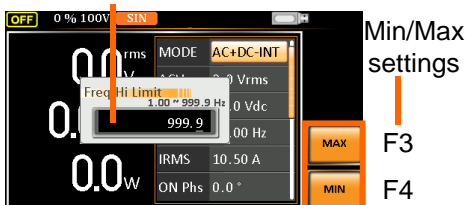



 Note

- Frequency limit setting is Not available under DC-INT, AC+DC-EXT, AC-EXT, AC+DC-Sync and AC-Sync output modes.
- Before change freq limit setting, if FREQ setting value is bigger than desire freq limit value, the freq limit value cannot be change accordingly.
- The range of frequency limit will be limited within the certain minimum value in accordance with the output frequency setting.
- There are 2 sets of frequency limits in total.

Setting the Output Frequency & Signal

Background The **FREQ** and **SIN** settings set the frequency of the output. Before setting the frequency, set the frequency limit.

Steps 1. Press the **F** key to access the **FREQ** or **SIG** parameter depending on varied modes. 

Also, it is available to use the scroll wheel followed by the **Enter** key to make the **FREQ** or **SIG** parameter selectable as well. 

2. Set the frequency or signal with the scroll wheel or with the **F1 ~ F4** soft-keys.

AC+DC-INT, AC+DC-ADD

FREQ	Range	1.00 ~ 999.9 Hz
	Soft-keys	DEF1, DEF2, MAX, MIN

AC-INT, AC-ADD, AC-VCA

FREQ	Range	40.00 ~ 999.9 Hz
	Soft-keys	DEF1, DEF2, MAX, MIN

AC+DC-Sync, AC-Sync

SIG	Option	LINE, EXT
------------	--------	-----------

3. Press **Enter** key to confirm the frequency or signal setting.

Defined Settings The **DEF1** and **DEF2** settings are user defined settings. By default they are set to 50.00 Hz and 60.00 Hz, respectively. The **MAX** and **MIN** soft-keys set the frequency to the maximum and minimum, respectively.

4. Repeat the previous steps 1 ~ 2 to set frequency with the scroll wheel.
5. Press and hold the *DEF1* or *DEF2* soft-key until "Saved to DEF1/2" is displayed. This will save the frequency setting to the DEF1 or DEF2 soft-key individually.

Frequency setting Defined setting

Example of Frequency Setting in AC+DC-INT

Signal setting

Example of Signal Setting in the AC+DC-EXT



Note

- Trying to set the frequency outside of the frequency limit will result in a frequency setting error being displayed on the screen.
- FREQ setting under each output mode has its own DEF1 and DEF2 saved values, respectively.

Setting the Peak Current Limit

Background Setting the peak current limit sets a limit on the current that can be sourced by the power supply. Once the output current over the setting, the output will set to off.

 **Note** When the peak current limit is tripped, an alarm will sound. Press *Shift + Cancel* to clear the IpK alarm.

- Steps**
1. Press *Shift + Irms* to access the IPK Limit menu.  + 
 2. Use the scroll wheel to toggle between IPK+ (upper) and IPK- (lower) settings followed by pressing *Enter* to get into parameter, respectively.

IPK+

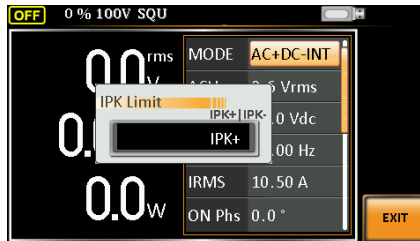

IPK-

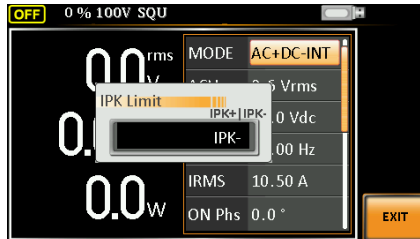

- Set the peak current (IPK+ & IPK-) with the scroll wheel or with the F3 (MAX) and F4 (MIN) soft-keys to set the current limit to the maximum and minimum values, respectively.

AC+DC-INT, AC-INT, DC-INT, AC+DC-EXT, AC-EXT, AC+DC-ADD, AC-ADD, AC+DC-Sync, AC-Sync, AC-VCA

IPK+	Range	40 ~ 105% of rate peak current
	Soft-keys	IPK Limit On/Off, MAX, MIN
IPK-	Range	-105 ~ -40% of rate peak current
	Soft-keys	IPK Limit On/Off, MAX, MIN

Example of IPK+ Limit Setting in the AC+DC-INT

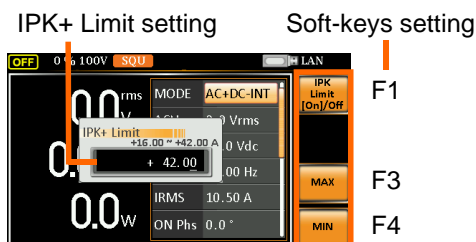

Example of IPK- Limit Setting in the AC+DC-INT

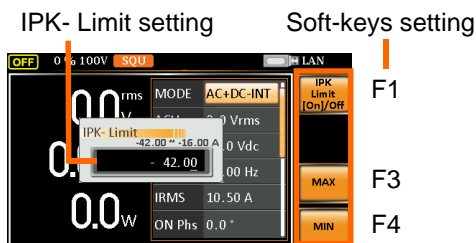

IPK Limit On/Off In theory, It is the function which keeps the IPK limits (+ & -) within the certain range when the predefined values are reached. If, however, this function is turned off, the output will be disabled instantly when either IPK+ or IPK- limit is reached.

4. Press Enter to confirm the peak current setting.



Note

IPK Limit is set ON by default.

Setting the Output Current Level

Background The IRMS and I settings set the current of the output. Setting the RMS or AVG current sets a limit on the current that can be sourced by the power supply. Once the output current is over the setting, the output will set to off.

Steps

1. Press *Irms* to access the IRMS or I menu depending on varied modes.



Also, it is available to use the scroll wheel followed by the Enter key to make the IRMS or I parameter selectable as well.



2. Set the IRMS/I level with the scroll wheel or with the F3 ~ F4 soft-keys. The MAX and MIN soft-keys set the IRMS or I level to the maximum and minimum, respectively.

AC+DC-INT, AC-INT, DC-INT, AC+DC-EXT, AC-EXT, AC+DC-ADD, AC-ADD, AC+DC-Sync, AC-Sync, AC-VCA

	Range	5% ~ 105% of rate current
IRMS/I	Soft-keys	IRMS Limit On/Off, MAX, MIN

IRMS setting Soft-keys setting

Example of IRMS
Setting in the
AC+DC-INT

I setting Soft-keys setting

Example of I
Setting in the
DC-INT

IRMS & I Limit
On/Off

Almost identical with the concept of previous IPK Limit function, the IRMS/I Limit function keeps the IRMS/I value within the certain limit when the predefined value is reached. If, on the other hand, this function is turned off, the output will be disabled instantly when IRMS/I Limit off level is reached.

Note

IRMS Limit is set ON by default. The IRMS minimum value will not be less than 0.25A.

Setting the Output On Phase

Background The on phase setting sets the starting phase of the voltage output.

Steps

1. Press *Shift* + *Menu* to make the ON Phs parameter selectable.

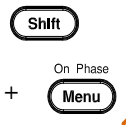

Also, it is available to use the scroll wheel followed by the Enter key to make the ON Phs parameter selectable as well.



2. Set the *ON Phs* setting with the scroll wheel or with the F3 (MAX) and F4 (MIN) soft-keys to set the On Phase to the maximum and minimum values, respectively.

AC+DC-INT, AC-INT, AC+DC-ADD, AC-ADD, AC+DC-Sync, AC-Sync, AC-VCA

ON Phs	Range	0.0° ~ 359.9°
	Soft-keys	FIXED/FREE, MAX, MIN

3. Press *Enter* to confirm the On Phase setting.

On Phase setting Soft-keys setting

Example of On Phase Setting

FIXED & FREE Modes Pressing the F1 key to toggle between modes of FIXED, which indicates the user-defined on-phase degree, or FREE, which represents the degree of on-phase is freely determined by the unit itself. When FREE is selected, the both F3-MAX and F4-MIN keys are grayed out, signaling the unavailability by user.

On Phase setting

Example of On Phase Setting in FREE Mode

Setting the Output Off Phase

Background The off phase setting sets the ending phase of the voltage output.

Steps

4. Use the scroll wheel followed by the Enter key to make the OFF Phs parameter selectable.



5. Set the *OFF Phs* setting with the scroll wheel or with the F3 (MAX) and F4 (MIN) soft-keys to set the Off Phase to the maximum and minimum values, respectively.

AC+DC-INT, AC-INT, AC+DC-ADD, AC-ADD, AC+DC-Sync, AC-Sync, AC-VCA

OFF Phs	Range	0.0° ~ 359.9°
	Soft-keys	FIXED/FREE, MAX, MIN

6. Press *Enter* to confirm the Off Phase setting.

OFF Phase setting

Soft-keys setting

Example of OFF Phase Setting

FIXED & FREE Modes

Pressing the F1 key to toggle between modes of FIXED, which indicates the user-defined off-phase degree, or FREE, which represents the degree of off-phase is freely determined by the unit itself. When FREE is selected, the both F3-MAX and F4-MIN keys are grayed out, signaling the unavailability by user.

OFF Phase setting

Example of OFF Phase Setting in FREE Mode

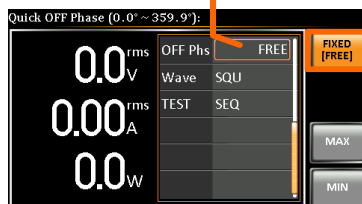

FREE selected

Setting the Sync Phase



Note

- It is available for AC+DC-Sync and AC-Sync Mode output modes only.
- When SIG is set LINE, this function is used for adjusting sync phase of output waveform and phase of power grid.
- When SIG is set EXT, this function is used for adjusting sync phase of output waveform and phase of external input signal.

Steps

1. Use the scroll wheel followed by the Enter key to make the Syn Phs parameter selectable. 
2. Set the *Syn Phs* setting with the scroll wheel or with the F3 (MAX) and F4 (MIN) soft-keys to set the Sync Phase to the maximum and minimum values, respectively.

AC+DC-Sync, AC-Sync

Syn Phs	Range	0.0° ~ 359.9°
	Soft-keys	MAX, MIN

3. Press *Enter* to confirm the Sync Phase setting.

Example of Sync Phase Setting

Sync Phase setting

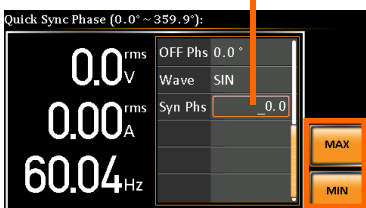

Soft-keys setting



The actual waveform –
ACV: 100 Vrms,
DCV: 100Vdc,
Syn Phs: 0°,
Output On

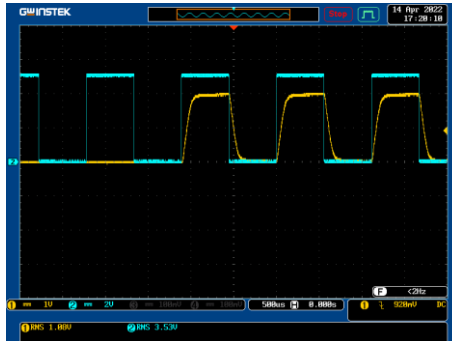

The actual waveform –
ACV: 100 Vrms,
DCV: 100Vdc,
Syn Phs: 0°,
Steady State

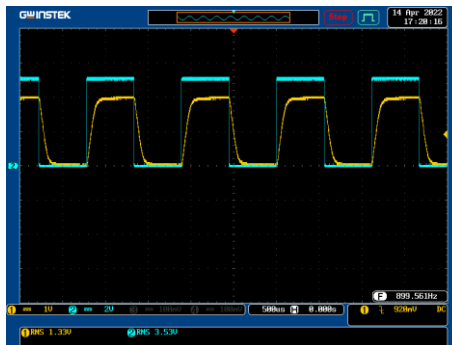

The actual waveform –
ACV: 100 Vrms,
DCV: 100Vdc,
Syn Phs: 0°,
Output Off

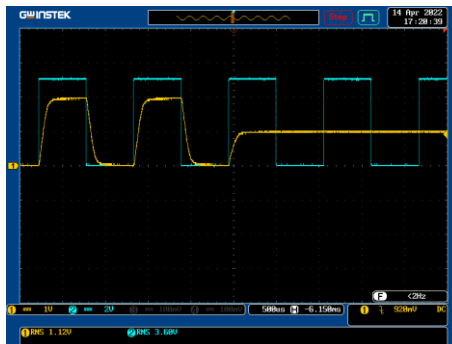

The actual waveform –
 ACV: 100 Vrms,
 DCV: 100Vdc,
 Syn Phs: 120°,
 Output On

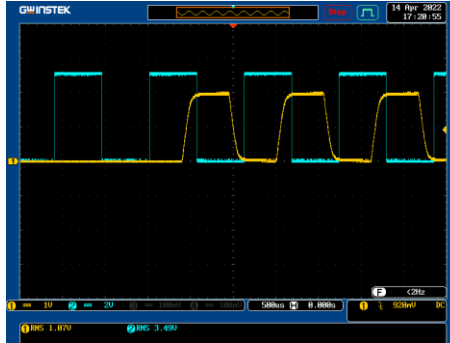

The actual waveform –
 ACV: 100 Vrms,
 DCV: 100Vdc,
 Syn Phs: 120°,
 Steady State

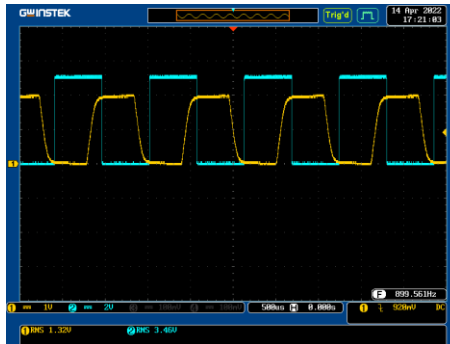

The actual waveform –
 ACV: 100 Vrms,
 DCV: 100Vdc,
 Syn Phs: 120°,
 Output Off

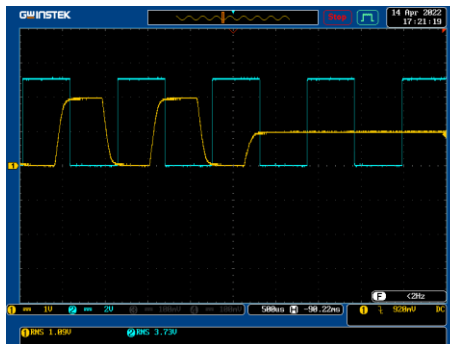

Switch the Display Modes

The ASR-2000 power supply has three display modes. The standard display mode shows the power supply setup in the middle and the 3 configurable measurements on the right that correspond to the far-left live-time measurements section. The simple display mode shows all measurement items available on the ASR-2000 with 3 measurement formats switchable at any time. The harmonic display mode shows both harmonic voltage and harmonic current relevant measurements for user.

Steps

1. Press the *Display* key.
2. The display mode will toggle each time when the key is pressed besides locked mode.

Display



Standard Mode

Measurement Setting

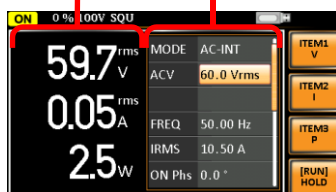

Configurable measurements

Hold measurement

Configuring the Standard Mode Measurements

1. Press the *F1*(ITEM1), *F2*(ITEM2) or *F3*(ITEM3) soft-key to enter each menu.



2. Use the scroll wheel to select a measurement item and press *Enter* to confirm. Refer to page 95 for more details of measurement parameters.

Simple Mode

Measurement Items

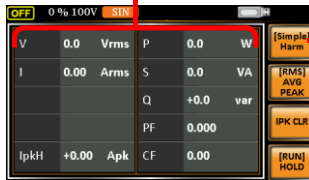

- Simple/Harm
- Measurement forms
- Hold measurement

Configuring the Simple Mode Measurements

1. Press the *F2* (RMS/AVG/PEAK) soft-key to toggle among each mode of format. 
2. The display will show parameters of measurement for each format. Refer to the page 98 for details.

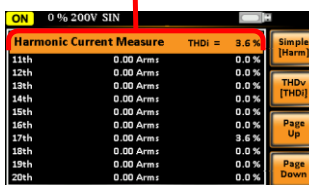

Harmonic Mode

Measurement Items



- Simple/Harm
- THDv/THDi
- Page Up
- Page Down

Configuring the Harmonic Mode Measurements

1. First switch to the Simple mode followed by pressing the *F1* (Simple/Harm) soft-key to enter the Harm display mode. 
2. Pressing the *F2* (THDv/THDi) soft-key to toggle between Total Harmonic Distortion Volt (THDv) and Total Harmonic Distortion Current (THDi) measurements. 



Harmonic mode is available for AC-INT mode and 50/60Hz output frequency. SIN, SQU, TRI and ARB 1 - 16 waveforms are also available.

3. When the measurements are beyond one page, which consists of up to 10 items, press the *F3* (Page Up) and *F4* (Page Down) soft-keys to flip through pages.

A rectangular button with a black border and a yellow-to-orange gradient background. The text "Page Up" is centered in black.A rectangular button with a black border and a yellow-to-orange gradient background. The text "Page Down" is centered in black.

Hold
Measurement

Press the soft-key *F4* to toggle hold on or off. This function will “hold” the current measurements on the display, which means the measurements won’t be updated until the function is released.

A rectangular button with a black border and a yellow-to-orange gradient background. The text "[RUN] HOLD" is centered in black.

Note

Hold measurement is available for the Standard and Simple display modes only.

Using the Measurement Function

The 3 configurable measurements, which indicate the live-time measurement in varied units, on the far-right side within the standard display mode can be switched by user anytime in the process of power output, thus providing an instantaneous analysis.

Steps

1. Press the *Display* key to switch to the Standard display mode.



2. Press the *F1(ITEM1)*, *F2(ITEM2)* or *F3(ITEM3)* soft-key to enter each menu.



3. Use the scroll wheel to select a measurement item and press *Enter* to confirm.

ITEM 1

V Root Mean Square Voltage

Vavg Average Voltage

Vmax Maximum Peak Value of Output Voltage

Vmin Minimum Peak Value of Output Voltage

P Real Power

S Apparent Power
(n/a in DC-INT mode)

Q Reactive Power
(n/a in DC-INT mode)

THDv Total Harmonic Distortion Voltage
(available in AC-INT mode only)

Example of
ITEM1 in
AC+DC-
Sync

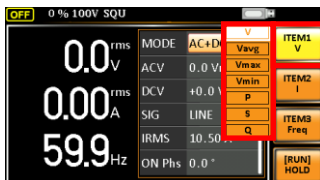

ITEM1
options

ITEM 2

I Root Mean Square Current

Iavg Average Current

I_{max} Minimum Peak Value of Output
Current

I_{min} Minimum Peak Value of Output
Current

I_{pkH} Peak Current Hold

PF Power Factor (n/a in DC-INT mode)

CF Crest Factor
(n/a in DC-INT mode)

THDi Total Harmonic Distortion Current
(available in AC-INT mode only)

Example of
ITEM2 in
AC+DC-
Sync

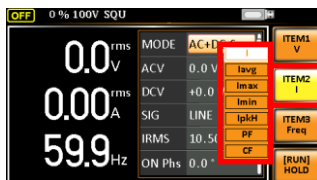

ITEM2
options

ITEM 3

P Real Power

S Apparent Power (n/a in DC-INT mode)

Q Reactive Power (n/a in DC-INT mode)

IpkH	Peak Current Hold
PF	Power Factor (n/a in DC-INT mode)
CF	Crest Factor (n/a in DC-INT mode)
Freq	Frequency (available in AC+DC-Sync and AC-Sync modes only)

Example of ITEM3 in AC+DC-Sync

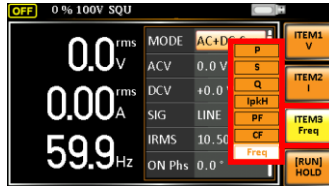

ITEM3 options

 Note

Each output mode has varied measurement functions display. Refer to the above tables for detailed options.

Switch the Measurement Format

The 3 measuring formats, RMS, AVG as well as PEAK, on the far-right side within the simple display mode can be switched by user anytime in the process of power output, thus offering an instant readout of diversified calculations.

Steps

1. Press the *Display* key to switch to the Simple display mode. 

2. Press the F2 (RMS/AVG/PEAK) soft-key to toggle among each mode of format. 

RMS Root Mean Square value

AVG Average value

PEAK Peak value

Example

DC-INT Output Mode

V & I
RMS
Values

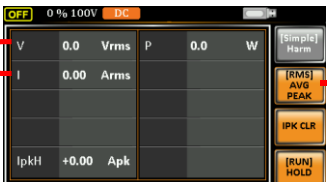

RMS Display

Vavg &
Iavg
Values

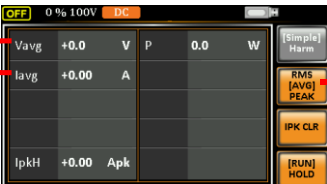

AVG Display

Vmax/
Vmin
&
Imax/
Imin
Values

OFF 0% 100V DC						[Simple] Harm
Vmax	+0.0	Vpk	P	0.0	W	RMS [AVG] [PEAK]
Vmin	+0.0	Vpk				
Imax	+0.00	Apk				
Imin	+0.00	Apk				
IpkH	+0.00	Apk				
						IPK CLR
						[RUN] HOLD

PEAK Display

All output modes except DC-INT

V & I
RMS
Values

OFF 0% 100V SIN						[Simple] Harm
V	0.0	Vrms	P	0.0	W	RMS [AVG] [PEAK]
I	0.00	Arms	S	0.0	VA	
			Q	+0.0	var	
			PF	0.000		
IpkH	+0.00	Apk	CF	0.00		
						IPK CLR
						[RUN] HOLD

RMS Display

Vavg &
Iavg
Values

OFF 0% 100V SIN						[Simple] Harm
Vavg	+0.0	V	P	0.0	W	RMS [AVG] [PEAK]
Iavg	+0.00	A	S	0.0	VA	
			Q	+0.0	var	
			PF	0.000		
IpkH	+0.00	Apk	CF	0.00		
						IPK CLR
						[RUN] HOLD

AVG Display

Vmax/
Vmin
&
Imax/
Imin
Values

OFF 0% 100V SIN						[Simple] Harm
Vmax	+0.0	Vpk	P	0.0	W	RMS [AVG] [PEAK]
Vmin	+0.0	Vpk	S	0.0	VA	
Imax	+0.00	Apk	Q	+0.0	var	
Imin	+0.00	Apk	PF	0.000		
IpkH	+0.00	Apk	CF	0.00		
						IPK CLR
						[RUN] HOLD

PEAK Display

 Note

The selected measurement format will be merely shown in the Simple display mode, for which refer to page 93 for further details.

Panel Lock

The panel lock feature prevents settings from being changed accidentally. When activated, all keys and knobs except the Lock/Unlock key and the Output key (if active) will be disabled.

If the instrument is remotely controlled via the USB/LAN/RS232/GPIB interface, the panel lock is automatically enabled. See page 182 for remote control details.

Activate the Panel Lock

Press the *Lock* key to activate the panel lock. “Keys locked” appears on the display.

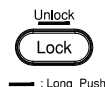

A lock icon will appear in the upper-right corner when the panel keys are locked.



Disable the Panel Lock

Hold the *Lock* key for ~3 seconds to disable the panel lock. “Keys unlocked” will appear on the display and the lock icon will disappear.

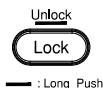

Example

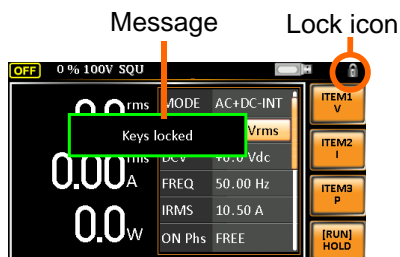

Alarm Clear

Background The ALM CLR (Alarm Clear) function will clear alarms like Over Current, Over Peak Current, Over Temperature, Power Input Anomaly, Fan fail, Remote Sense Error, among others. Refer to page 210 for more details.

Steps 1. Press *Shift + Cancel* to clear any alarms.

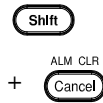

Example

ALM indicator

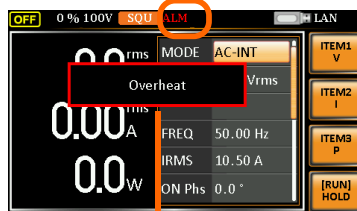

Alarm message

Turning the Output On/Off

When the output is turned on, the DUT can be connected to either the rear panel output or the front panel output.



WARNING

Both of these outputs are electrically linked. Only one DUT should be connected to any one of the outputs at a time. Using both outputs at the same time is not supported. Using the front and rear outputs at the same time could cause dangerous operating conditions. See page 37 for details about using the output terminals or sockets.

Turn Output On

Press the *Output* key. The Output key will light up in orange and ON will be displayed in the status bar to indicate that the output is on.



Turn Output Off

Press the *Output* key. The Output key light will go out and OFF will be displayed in the status bar to indicate that the output is off.



Advanced Settings

- Using the Remote Sense Function → from page 103
- Preset Settings → from page 106

Using the Remote Sense Function

The ASR-2000 can be operated using local or remote voltage sense. By default, the power supply is configured for local sense.



WARNING

- Ensure the output is off before handling the remote sense connectors.
- Use sense cables with a voltage rating exceeding the isolation voltage of the power supply.
- Never connect sensing cables when the output is on. Electric shock or damage to the power supply could result.

Remote Sensing Input Connectors Overview

The remote sensing input connector is located at the rear panel of the ASR-2000.



Local Sense

Local Sense Operation

When using local sense, the remote sensing input terminal is not used. No compensation of any possible voltage drop seen on the load cables is performed. Local sense is only recommended when the voltage drop is of no consequence. By default, the power supply is configured for local sense.

1. Check that the remote sense setting is disabled (page 135).

Remote Sense

Remote Sense Operation

Remote sense is used to compensate for the voltage drop seen across load cables due to resistance inherent in the load cables. The remote sense function can compensate a maximum of 5% of the output voltage and all of output frequency.

1. Configure the remote sense setting to ON (page 135).
2. Connect the Neutral terminal of the remote sense terminal block to the Neutral terminal of the load.
3. Connect the Live terminal of the remote sense terminal block to the Live terminal of the load.

Connection Example

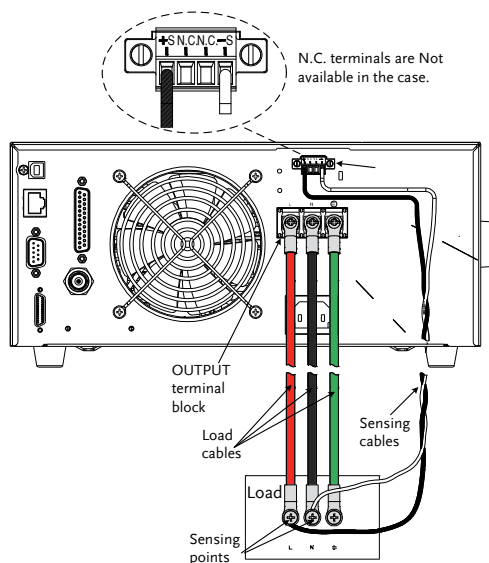

 Note

Do Not connect any wires to the N.C terminals of the remote sense terminal block.

4. After well connecting, cover the protective lid onto the remote sensing input terminal block followed by fastening the screw as figure shown below.

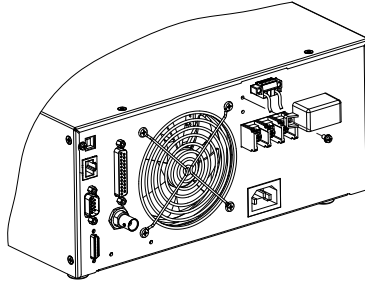

5. The remote sense connection along with the protective lid is therefore well set up.

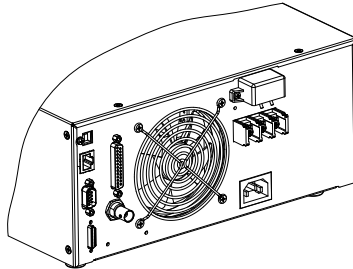

Preset Settings

Save Preset Settings to Local Memory

Up to 10 preset settings can be saved to internal memory.

Steps

1. Press *Preset* followed by clicking with holding on the F1 ~ F4 soft-keys individually to save the present settings to the corresponding memory number.

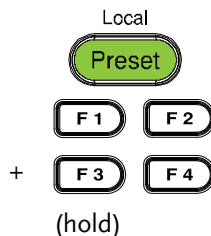

Presets M0 ~ M3

2. Press the *Preset* key again to exit from the preset mode.

Example

For example, pressing *Preset* & holding *F1* will save the present settings to memory slot 0 (saved to M0).



Note

- There are overall 10 groups of memory number for preset setting (M0 ~ M9). Only M0 ~ M3 are available in soft-keys, whereas the rest groups M4 ~ M9 can be saved in the *Save/Recall Files* utility under Menu system. Refer to page 108 for more details.
- The preset key will be lit green when active. A beep will be heard (Buzzer is set to ON) and a message will displayed when the settings are saved.

Load Preset Settings to Local Memory

Any of the 10 preset settings can be recalled from internal memory.

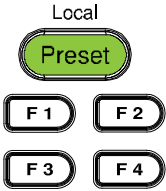
- | | | |
|-------|--|---|
| Steps | 1. Press <i>Preset</i> followed by clicking on the F1 ~ F4 soft-keys individually to load the corresponding memory number. |  |
| | + | |
| | Presets | M0 ~ M3 |
| | 2. Press the <i>Preset</i> key again to exit from the preset mode. | |
-

Example	For example, pressing <i>Preset</i> + F1 will recall the saved settings from memory slot 1 (recalled from M0).
---------	--

- | | |
|---|---|
|  Note | <ul style="list-style-type: none"> • There are overall 10 groups of memory number for preset setting (M0 ~ M9). Only M0 ~ M3 are available in soft-keys, whereas the rest groups M4 ~ M9 can be recalled in the <i>Save/Recall Files</i> utility under Menu system. Refer to page 108 for more details. • The preset key will be lit green when active. A beep will be heard (Buzzer is set to ON) and a message will displayed when the settings are recalled. |
|---|---|
-

Manage Preset Settings

Preset settings can be easily saved to or recalled from a USB flash drive using the Save/Recall Files utility in the Menu system. Settings can also be deleted (Recalled Default) from local memory using the utility.

File Format When files are saved to USB they are saved in the following format:
 PresetX.Set, where X is the memory number M0 ~ M9. The files are saved to USB:/gw.

When files are recalled from USB, files must be recalled from the same memory number. For example, the file Preset0.set can only be recalled to memory number M0. The files can only be recalled from the USB:/gw directory.

- Steps**
1. Press the *Menu* key. The Menu settings will appear on the display. 
 2. Use the scroll wheel to go to item 10, *Save/Recall Files* and press *Enter*.
 3. Go to the *Type* setting using the scroll wheel and press *Enter*. Select *Preset* and press *Enter* to confirm.
 4. Go to the *Action* setting and choose the file operation and then press *Enter*.

MEM→USB Saves the selected preset memory from the local memory to a USB flash drive.

MEM←USB Loads a preset memory from a USB flash drive to the selected local memory.

Delete	Deleted (Recalled Default) the selected preset memory from local memory.
Save	Saves the selected preset memory to local memory.
Recall	Recalls the selected preset memory from local memory.

- Go to the *Memory No.* setting and select the preset memory number to perform the operation on. Press *Enter* to confirm.

Memory No. 0 ~ 9 (M0 ~ M9)

Execute File Operation	6. Press <i>EXE[F1]</i> to perform the selected file operation.	
------------------------	---	---

Exit	7. Press <i>EXIT[F4]</i> to exit from the <i>Save/Recall Files</i> settings.	
------	--	---

Example

Load file from USB to Local memory

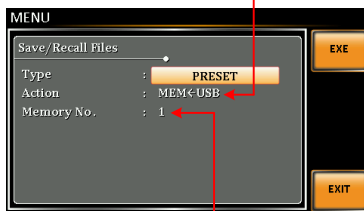

Memory No. 1 selected

- | | |
|--------------------|---|
| All Data Operation | 8. Go back to the <i>Type</i> setting using the scroll wheel and press <i>Enter</i> . Select <i>All Data</i> and press <i>Enter</i> to confirm. |
| | 9. Go to the <i>Action</i> setting and choose the file operation and then press <i>Enter</i> . |

MEM→USB	Saves all the files including Preset, Sequence, Simulate and ARB from the local memory to a USB flash drive.
<hr/>	
MEM←USB	Loads all the files including Preset, Sequence, Simulate and ARB from a USB flash drive to the local memory.
<hr/>	
Delete	Deletes all the files including Preset, Sequence, Simulate and ARB from local memory.

Example

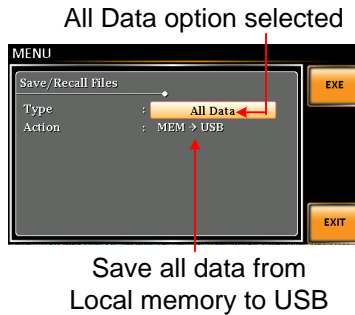

External Keypad Operation

USB Keypad

ASR series supports external keypad, via USB connection, to execute operations including setting and output. Refer to the table below for functions of each key from external keypad.

Key	Function
TAB	Scale -->
/	Set Voltage
*	Set Frequency
0 ~ 9,00, .	Value input
+	Stepping increase Voltage (or Frequency)
-	Stepping decrease Voltage (or Frequency)
Enter	Enter
Back Space	Output On/Off



Note

This function is Not available for firmware versions prior to V1.20. Please update to the latest firmware and kernel to activate this function. Visit GWInstek official website to download the latest firmware and refer to the update procedure for details.

EXTERNAL CONTROL

The rear panel has 3 signal output connectors. These connectors are used for external control from the menu of this product by using the external signal that includes amplified external voltage, amplified external signal as well as synchronization frequency.

Note that prior to operation, it is required to implement insulation process for external circuit. For example, while connecting to I/O signals of ASR-2000, be sure to have double insulation process for live parts in advance.

Furthermore the state output is always on. The following chapter will give a brief overview each of these connectors.

Using External Control I/O	113
Using External Signal Input Function.....	114
EXT GAIN - AC+DC-EXT and AC-EXT mode.....	115
EXT ADD - AC+DC-ADD and AC-ADD mode	116
EXT Sync - AC+DC-Sync and AC-Sync mode.....	116
EXT Voltage - AC-VCA mode.....	117
Compiling Arbitrary Waveform Input	118
Manage Arbitrary Waveform Settings	125

Using External Control I/O

Overview The External Control I/O is primarily used to control ASR-2000 externally by using the logic signal. More than that, it is able to monitor Sequence function status remotely with ease.



Note

Before executing this function, make sure it is ON status via going to MISC – EXTERNAL CONTROL. Properly read the EXTERNAL CONTROL chapter before using.

Specification	Control input	<ul style="list-style-type: none"> • High level: +2.2 V or higher • Low level: +1.0 V or lower • Non-destructive maximum input: +7 V / -5 V • Input Impedance: Pulled up to +5 V with 47 kΩ
	Status output	<ul style="list-style-type: none"> • Output level: 0 / +5 V • Output Impedance: 100 Ω

Pin Assignment Check the table below for definition of each pin.

Pin No.	I/O	Function	Remark
1	Output	Power source on/off status	0: OFF, 1: On
2	Output	The output on/off status	0: OFF, 1: On
3	Output	IRMS / IPK / Power Limit	0: OFF, 1: On
4	Output	Software busy status	0: Normal, 1: Busy
5	Output	Sequence sync output 0	
6	Output	Sequence sync output 1	
7	Output	Trigger output	
8	Output	Undefined output 1	
9	GND		
10	Input	Undefined input 0	
11	Input	Output off	Falling edge detection
12	Input	Output on	Falling edge detection
13	Input	Sequence start	Falling edge detection
14	Input	Sequence stop	Falling edge detection
15	Input	Sequence hold	Falling edge detection

16	Input	Sequence branch 1	Falling edge detection
17	Input	Sequence branch 2	Falling edge detection
18	GND		
19	Output	+5 V	50 mA or less
20	Output	Reserved	
21	Output	Reserved	
22	Output	Reserved	
23	Output	Reserved	
24	Output	Reserved	
25	Output	Reserved	



Note

The limiter operation is recognized as On when the following conditions exist.

- Output peak current limiter (positive) is operated.
- Output peak current limiter (negative) is operated.
- Output average current limiter is operated.
- Output power limiter is operated.

Using External Signal Input Function

Overview

The External Signal Input port is particularly used for several output modes including AC+DC-EXT, AC-EXT, AC+DC-ADD, AC-ADD, AC+DC-Sync and AC-Sync, AC-Sync and AC-VCA.

Connect to the External Signal Input port on the rear panel via a coaxial cable with a BNC connector when using an external input signal as the signal source with external synchronization.

External Signal
Input Connector

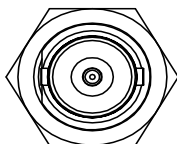

EXT GAIN - AC+DC-EXT and AC-EXT mode

Overview Select AC+DC-EXT or AC-EXT mode to use ASR-2000 as an amplifier specifically for signal input from the external signal input port on the rear panel. The impedance of input is 1MΩ, whilst the frequency range of input is from DC to 999.9 Hz.

External Input Gain Range	External Input Gain	
	Setting	Setting Range
	100V Range	200V Range
	0.0 to 250.0	0.0 to 500.0
	Resolution	0.1
	Initial Value	100.0

Equation Output voltage (V) =
External input signal (V) × Gain (V/V)

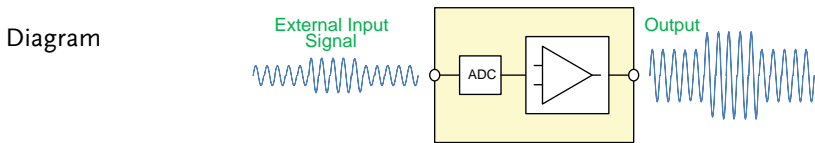

! Note

- It is suggested to use an input voltage of ±2.5 V or less to prevent from clipping of the output voltage.
- In addition, never allow an input voltage to pass ±5.5V to avoid issues from the input block.

EXT ADD - AC+DC-ADD and AC-ADD mode

Overview & Concept Select AC+DC-ADD or AC-ADD mode to add the external signal source signal that includes magnification to the internal signal then power output on the rear panel. The impedance of input is $1M\Omega$, whilst the frequency range of input is from DC to 999.9 Hz.

EXT Sync - AC+DC-Sync and AC-Sync mode

Overview When AC+DC-Sync or AC-Sync mode is selected, the externally synchronized oscillation function embedded in the ASR-2000 synchronizes the output frequency, specifically, to the frequency of external synchronization TTL signal. It is not allowed to set the synchronization phase difference and the output frequency is able to be synchronized to frequency from 40 to 999.9 Hz.

Diagram & Concept For SIG option, choose either EXT (signal sync) or LINE (line sync) for external sync signal source. It is noted that synchronous is with power source frequency when LINE is opted. See page 79 for operation steps.

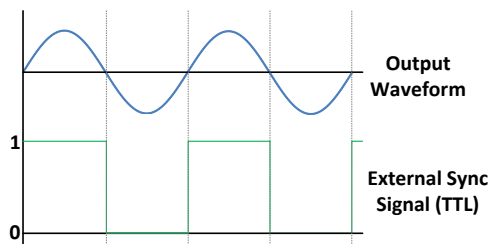

 **Note**

The limit frequency range of synchronous TTL signal is 40Hz ~ 1kHz. If TTL signal is greater than 1kHz, output will be disabled automatically.

EXT Voltage - AC-VCA mode

Overview

Select AC-VCA mode to use ASR-2000 as an amplifier specifically for DC input from the external signal input port on the rear panel. The input voltage range of input is from DC 0 to 2.5V. The impedance of input is 1MΩ.

Diagram

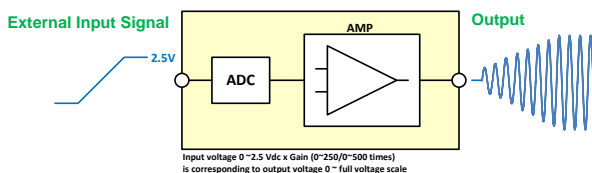

Note

After magnification, if exceeds the maximum DC voltage value of the range that output waveform will be clamped.

Compiling Arbitrary Waveform Input

Background

In order to generate arbitrary waveforms, it is requested to use a specifically control software on external PC which transfers data, via USB interface, to the arbitrary waveform memory with ASR-2000. Go to GWInstek official website to download the ARB waveform compiling program.



Note

- Arbitrary waveforms cannot be changed when output is on. To change arbitrary waveform, make sure the output is off beforehand.
- It is not allowed to compile the arbitrary waveform memory directly from ASR-2000. Only connecting with a PC with control software via USB interface can complete it.

Memory

- ✓ Arbitrary waveform memory count: 16
- ✓ Arbitrary waveform length: 4096 words
- ✓ Arbitrary waveform data: 16-bit binary (2's complement format)
- ✓ Valid range of waveform data: -32767 to 32767
When a value greater than 32767 is input, waveform data will be clipped to 32767. Also, when a value less than -32767 is input, the waveform data will be clipped to -32767.

Output Arbitrary Waveform on ASR-2000

1. Press *Shift* + *Test* to access the Wave menu.

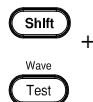

Alternatively, it is available to use scroll wheel followed by the *Enter* key to enter the Wave menu.



2. Choose one of the ARB waveforms (ARB 1 to ARB 16) with scroll wheel.

Default Waveform Setting

ARB 1 Ramp (rising)

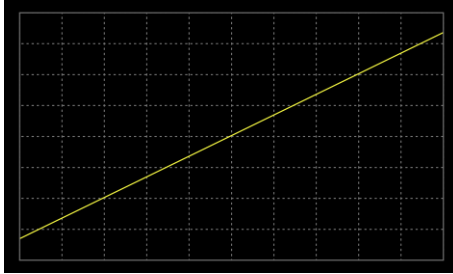

ARB 2 Ramp (falling)

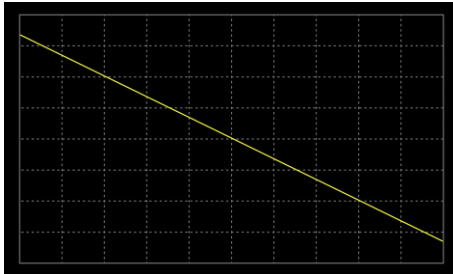

ARB 3 Sine wave, half-cycle(positive pole)

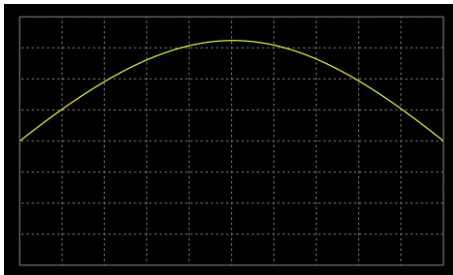

ARB 4 Sine wave, half-cycle(negative pole)

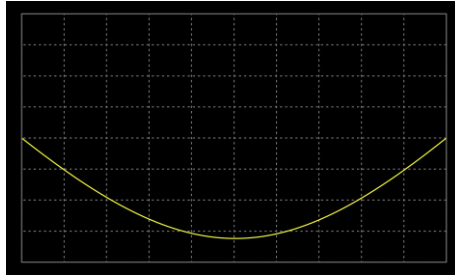

ARB 5 Sine wave, half-wave rectification(positive polarity)

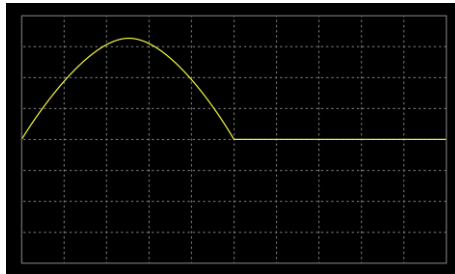

ARB 6 Sine wave, half-wave rectification(negative polarity)

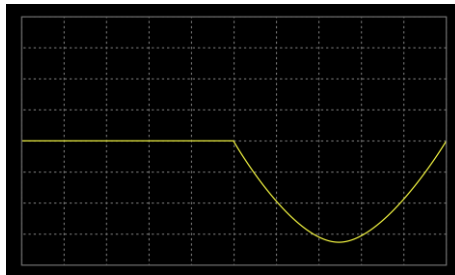

ARB 7 Sine wave, full-wave
rectification(positive polarity)

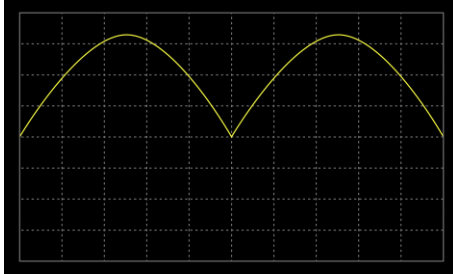

ARB 8 Sine wave, full-wave
rectification(negative polarity)

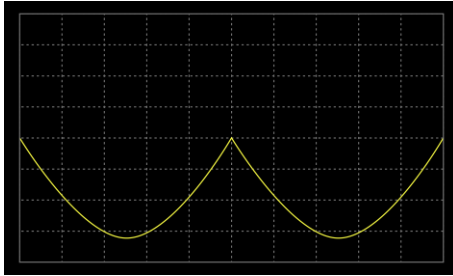

ARB 9 Second order step response(damping
coefficient 0.1)

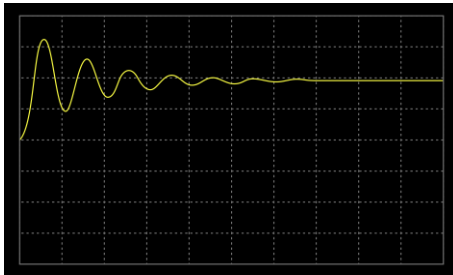

ARB 10 Second order step response(damping coefficient 0.2)

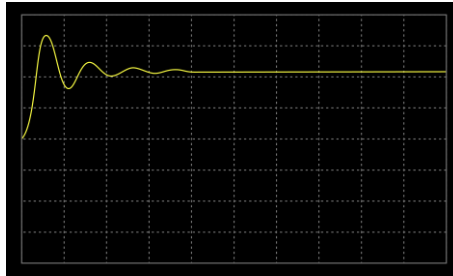

ARB 11 Second order step response(damping coefficient 0.7)

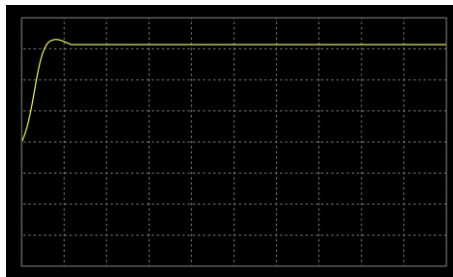

ARB 12 Second order impulse response(damping coefficient 0.1)

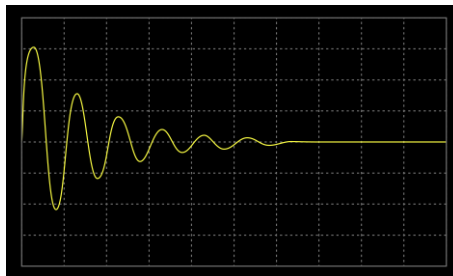

ARB 13 Second order impulse
response(damping coefficient 0.2)

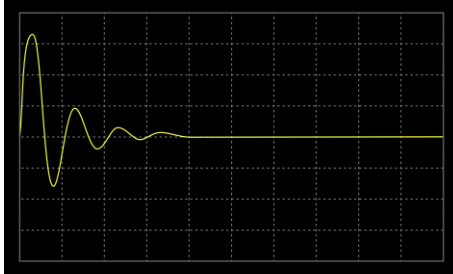

ARB 14 Second order impulse
response(damping coefficient 0.7)

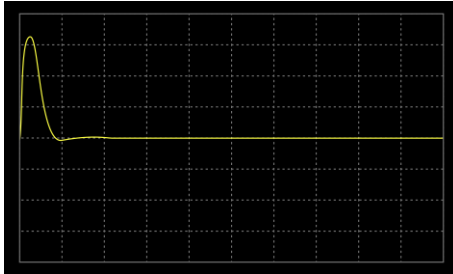

ARB 15 Exponential (rising)

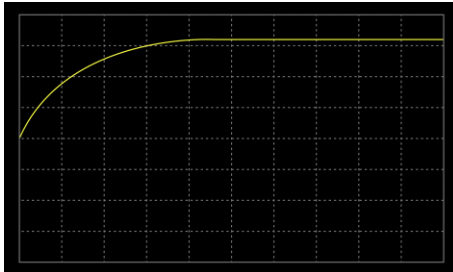

ARB 16 Exponential (falling)

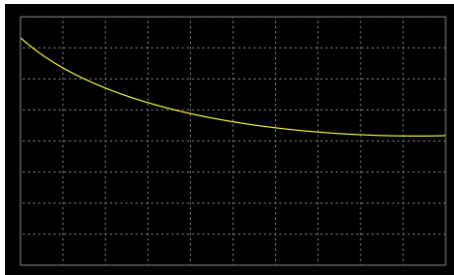

Note

Only FW version V1.07 above can support the above default waveform.



Note

Del ARB1~16 restores back to Default for ARB1~16 (page 125~126). Del All Data restores back to Default for all ARB (page 126~127).

3. Press *Enter* to confirm the waveform setting.

Example

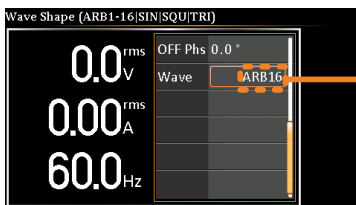

ARB 16 selected



Note

When the input peak value of ARB waveform is not in the full scale 32768, the ratio of maximum value of voltage output by ARB waveform will decrease accordingly.

Manage Arbitrary Waveform Settings

Arbitrary waveform settings can be easily saved to or from a USB flash drive using the Save/Recall Files utility in the Menu system. Files can also be deleted from local memory using the utility.

File Format	<p>When files are saved to USB they are saved in the following format: ARBX.ARB, where X is the memory number 1 ~ 16 (ARB0 ~ ARB16). The files are saved to USB:/gw.</p> <p>When files are recalled from USB, files must be recalled from the same memory number. For example, the file ARB1. SEQ can only be recalled to memory number ARB1. The files can only be recalled from the USB:/gw directory.</p>
Steps	<ol style="list-style-type: none"> 1. Press the <i>Menu</i> key. The Menu settings will appear on the display.  2. Use the scroll wheel to go to item 10, <i>Save/Recall Files</i> and press <i>Enter</i>. 3. Go to the <i>Type</i> setting using the scroll wheel and press <i>Enter</i>. Select <i>ARB</i> and press <i>Enter</i> to confirm. 4. Go to the <i>Action</i> setting and choose the file operation and then press <i>Enter</i>.
	<p>MEM→USB Saves the selected ARB memory from the local memory to a USB flash drive.</p>
	<p>MEM←USB Loads the ARB memory from a USB flash drive to the selected local memory.</p>

Delete	Deletes the selected ARB memory from local memory.
--------	--

- Go to the *Memory No.* setting and select the sequence memory number to perform the operation on. Press *Enter* to confirm.

Memory No.	1 ~ 16 (ARB1 ~ ARB16)
------------	-----------------------

Execute File Operation

- Press *EXE[F1]* key to perform the file operation.



Exit

- Press *EXIT[F4]* key to exit from the *Save/Recall Files* settings.



Example

Load file from USB to Local memory

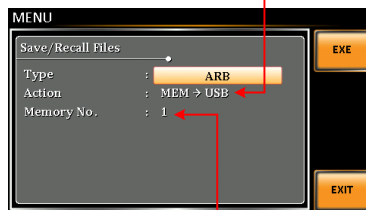

Memory No. 1 selected

All Data Operation

- Go back to the *Type* setting using the scroll wheel and press *Enter*. Select *All Data* and press *Enter* to confirm.
- Go to the *Action* setting and choose the file operation and then press *Enter*.

MEM→USB	Saves all the files including Preset, Sequence, Simulate and ARB from the local memory to a USB flash drive.
---------	--

MEM←USB	Loads all the files including Preset, Sequence, Simulate and ARB from a USB flash drive to the local memory.
Delete	Deletes (Recall Default) all the files including Preset, Sequence, Simulate and ARB from local memory.

Example

All Data option selected

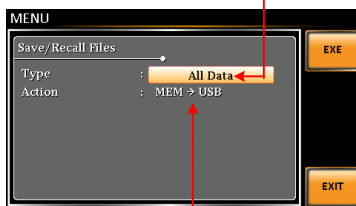

Save all data from Local memory to USB

Single Arbitrary Wave Default From the previous step 4, execute the “Delete” action to restore the selected ARB memory back to the default setting.

All Arbitrary Waves Default From the previous step 9, execute the “Delete” action to restore the entire ARB memory back to the default setting.

 **Note**

For default ARB waveform setting, please refer to page 119 through 126.

MISCELLANEOUS

The Miscellaneous menu contains miscellaneous parameter settings.

T Ipeak, hold	129
IPK CLR	131
Power ON	132
Buzzer	134
Remote Sense	135
Slew Rate Mode	137
Output Relay	139
THD Format	140
External Control	142
V Unit	143
ACin Detection	144
Trigger Out Width	146
Data Average Count	149
Data Update Rate	150

T Ipeak, hold

The T Ipeak, hold function sets the hold time for the peak current measurement. After the output is turned on, the ASR-2000 will delay starting the peak current measurement by this hold time.

Concept in diagram

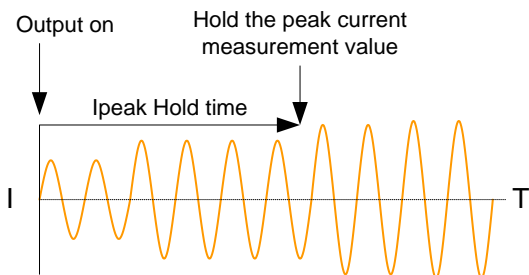

Note

- The hold peak current will be updated when new measurement is greater than the previous value. By contrast, it will not update when new measurement is less than the hold peak current.
- Ipeak hold time begins counting only when the output function is turned on.
- Ipeak measurement is not executed during the set Ipeak hold time.

Steps

1. Press the *Menu* key. The Menu setting will appear on the display. 
2. Use the scroll wheel to go to item 2, *MISC Configuration* and press *Enter*.
3. Go to the *T Ipeak, hold(msec)* setting using the scroll wheel and press *Enter*. Set the time and press *Enter* again to confirm.

T Ipeak 1 ~ 60,000 ms

Exit

4. Press *Exit*[F4] to exit from the MISC Configuration settings.



Example

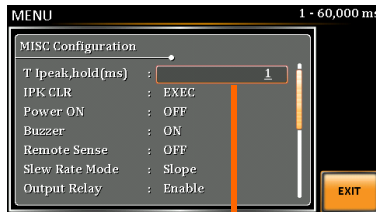

Hold time of current peak value setting

IPK CLR

The peak current measured during output process can be easily cleared out via this function. It is applicable for user to restart measuring the peak current value when necessity emerges.

Steps

1. Press the *Menu* key. The Menu setting will appear on the display. 
2. Use the scroll wheel to go to item 2, *MISC Configuration* and press *Enter*.
3. Go to the *IPK CLR* setting using the scroll wheel and press *Enter* on the EXEC button. The measured hold peak current value will be zeroed immediately.

IPK CLR EXEC

Exit

4. Press *Exit[F4]* to exit from the MISC Configuration settings.



Example

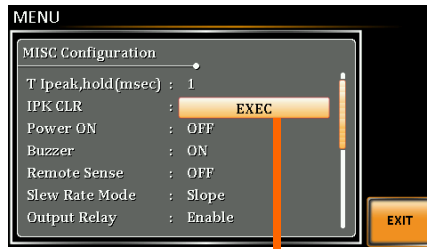

Current peak hold
value clear



Although the hold peak current will be zeroing at once right after the execution of *Ipkh CLR* action, the zeroing value, however, will be soon updated when new measurement greater than 0 occurs during output process.

Power ON

The Power ON setting allows you to have the power-on output or other operation functions on automatically after startup. The settings that are loaded are the last settings that were present in the standard mode before the unit was turned off last.

Steps

1. Press the *Menu* key. The Menu setting will appear on the display. 
2. Use the scroll wheel to go to item 2, *MISC Configuration* and press *Enter*.
3. Go to the *Power ON* setting using the scroll wheel and press *Enter*. Select a setting and press *Enter* to confirm.

ON	Set power-on output ON with the setting that was loaded before the unit was last turned off.
OFF	Disable this function active.
SEQ	Execute the sequence that was loaded before the unit was last turned off.
SIM	Execute the simulation that was loaded before the unit was last turned off.

Exit

4. Press *Exit*[F4] to exit from the MISC Configuration settings. 

Example

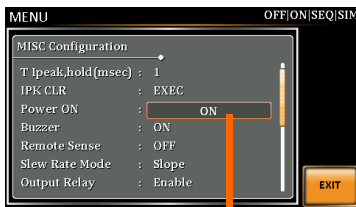

Power ON setting

Buzzer

The Buzzer setting turns the buzzer sound on or off for key presses.

Steps

1. Press the *Menu* key. The Menu setting will appear on the display. 
2. Use the scroll wheel to go to item 2, *MISC Configuration* and press *Enter*.
3. Go to the *Buzzer* setting using the scroll wheel and press *Enter*. Turn the setting on or off and press *Enter* again to confirm.

Buzzer ON, OFF

Exit

4. Press *Exit*[F4] to exit from the MISC Configuration settings. 

Example

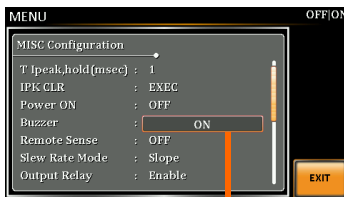

Buzzer setting

Remote Sense

The remote sense function detects the output voltage at the sensing input terminal. This function compensates for voltage drops across the load cables when the load is connected to the ASR-2000 over a long distance.



Note

The remote sense function can compensate a maximum of 5% of the output voltage. The maximum output voltage when compensation is used is limited by the rated voltage.

Steps

1. Press the *Menu* key. The Menu setting will appear on the display. 
2. Use the scroll wheel to go to item 2, *MISC Configuration* and press *Enter*.
3. Go to the *Remote Sense* setting using the scroll wheel and press *Enter*. Turn the setting on or off and press *Enter* again to confirm.

Remote Sense ON, OFF

Exit

4. Press *Exit*[F4] to exit from the MISC Configuration settings. 

Example

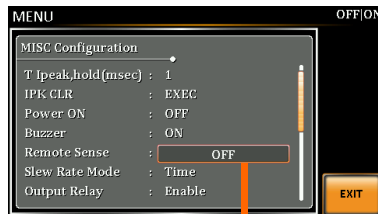

Remote Sense setting



Note

Remote sense function for AC-INT, DC-INT, AC-SYNC mode and 100V, 200V range and SIN wave shape and slew rate mode on Time Only.

Display

When the remote sense function is on, the displayed voltage value is the voltage measured at the sense terminal and the symbol "SENS" is displayed on the status bar for standard and simple mode display.

SENS displayed

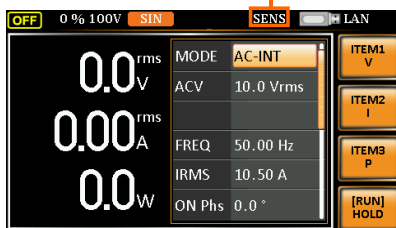

WARNING

- Before connecting the remote sense cables, turn off the output and peripherals. Please see page 103 for more information on the remote sense cabling instructions.
- If the remote sense wires are loose or falling (specifically the remote sense terminal + and the load terminal + & -), the display would show a warning message as below.

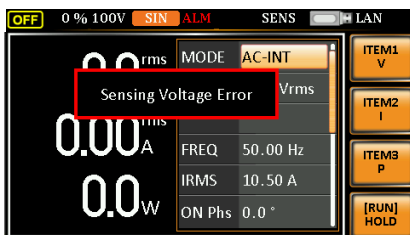

Slew Rate Mode

The slew rate, which is described as the fluctuating change of voltage per unit of time, can be customized by user in the 2 modes containing Time and Slope elaborated below for ASR-2000 models.

Steps

1. Press the *Menu* key. The Menu setting will appear on the display.  On Phase
2. Use the scroll wheel to go to item 2, *MISC Configuration* and press *Enter*.
3. Go to the *Slew Rate Mode* setting using the scroll wheel and press *Enter*. Choose the slew rate mode and press *Enter* again to confirm.

Time Regardless of the output voltage scale, the rising time of slew rate is definitely no more than 100 μ s.

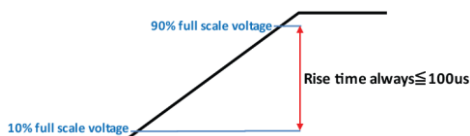

Slope The rising slew rate is constantly fixed in 1.5 V/ μ s with varied rising time in accord with differed output voltage scale.

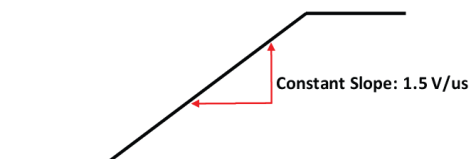

Exit

4. Press *Exit[F4]* to exit from the MISC Configuration settings.





Note

Voltage drop occurs in output voltage due to the set waveform or frequency under the Slope mode. It is suggested to adopt the Time mode when precise sine wave voltage output is required.

Example

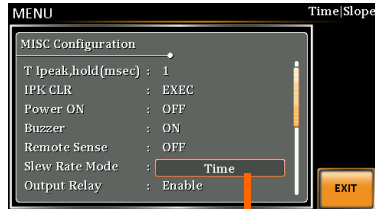

Slew Rate setting

Output Relay

The internally built-in output relay function has close relation with the power output function by default. That is to say, when output is on, the output relay will be activated if output relay is enabled; by contrast, the output relay will be deactivated when output is off. On the other hand, output relay function disabled means output terminal is under the condition of high impedance and output relay retains the state of conducting for good, which is suitable for the condition of turning output on/off rapidly.

Steps

1. Press the *Menu* key. The Menu setting will appear on the display. 
2. Use the scroll wheel to go to item 2, *MISC Configuration* and press *Enter*.
3. Go to the *Output Relay* setting using the scroll wheel and press *Enter*. Enable or disable output relay mode and press *Enter* again to confirm.

Output Relay Enable, Disable

Exit

4. Press *Exit*[F4] to exit from the MISC Configuration settings.



Example



Output Relay setting

THD Format

Choose one of the THD (Total Harmonic Distortion) equations. The equations of 2 varied modes (IEC by default) of Harmonic Format below are for, specifically, by the time the upper limit of measured harmonic order is 100.

Steps

1. Press the *Menu* key. The Menu setting will appear on the display. 
2. Use the scroll wheel to go to item 2, *MISC Configuration* and press *Enter*.
3. Go to the *THD Format* setting using the scroll wheel and press *Enter*. Choose the harmonic mode and press *Enter* again to confirm.

IEC & Equation The ratio of rms value of the second to the 100th harmonic component is computed to that of the fundamental.

$$\frac{\sqrt{\sum_{O=2}^N (F_o)^2}}{F_1} \times 100$$

CSA & Equation The ratio of rms value of the second to the 100th harmonic component is computed to that of the rms value of the first to 100th component.

$$\left[\frac{\sqrt{\sum_{O=2}^N (F_o)^2}}{\sqrt{\sum_{O=1}^N (F_o)^2}} \right] \times 100$$

-
- | | |
|-----------|---|
| Parameter | <ul style="list-style-type: none">▪ F₁: Fundamental (1st harmonic) component▪ F_O: Fundamental or harmonic component▪ O: Measured harmonic order▪ N: Always 100 |
|-----------|---|
-

Exit

4. Press *Exit*[F4] to exit from the MISC Configuration settings.



Example

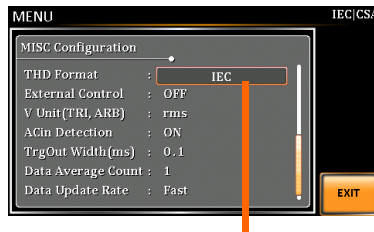

THD Format setting

External Control

User can enable or disable the External Control I/O input. When External Control I/O input is set as disabled, the ASR-2000 series status will remain output.

Steps

1. Press the *Menu* key. The Menu setting will appear on the display. 
2. Use the scroll wheel to go to item 2, *MISC Configuration* and press *Enter*.
3. Go to the *External Control* setting using the scroll wheel and press *Enter*. Enable or disable External Control I/O and press *Enter* again to confirm selection.

ON Signal will be input from the pin 12 to the pin 18 of External Control I/O, and ASR-2000 series is able to receive external input signal and execute control action.

OFF Signal will be input from the pin 11 to the pin 18 of External Control I/O, and ASR-2000 series is Not able to receive external input signal.

Example

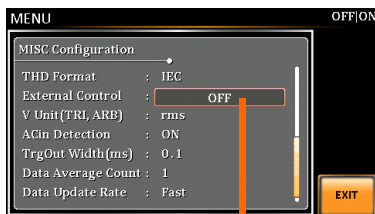

External Control setting

V Unit

User can freely select voltage set value unit as either RMS or PEAK only when output waveform is selected TRI or ARB.

Steps

1. Press the *Menu* key. The Menu setting will appear on the display. 
2. Use the scroll wheel to go to item 2, *MISC Configuration* and press *Enter*.
3. Go to the *V Unit* setting using the scroll wheel and press *Enter*. Choose the setting voltage unit and press *Enter* again to confirm selection.

rms Set the setting voltage unit to rms for all of output waveform.

p-p Set the setting voltage unit to peak for TRI and ARB output waveform only.

Example

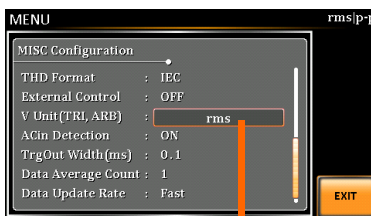

V unit setting

ACin Detection

This function, in essence, allows user to enable or disable the input power detection.

Steps

1. Press the *Menu* key. The Menu setting will appear on the display. On Phase
Menu
2. Use the scroll wheel to go to item 2, *MISC Configuration* and press *Enter*.
3. Go to the *Acin Detection* setting using the scroll wheel and press *Enter*. Enable or disable ACin Detection and press *Enter* again to confirm selection.

Input Detection: When Output is On and it detects input power abnormal, the message ON “ Power Input Anomaly” will be displayed. Be noted that buzzer sounds and ALM status shows when Buzzer is On.

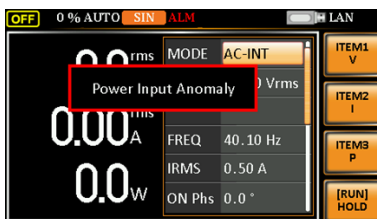

Input Detection: ON
 When Output is Off and it detects input power abnormal, the message “System Shutdown” will be displayed. Be noted that buzzer couldn’t sound and ALM status couldn’t show when Buzzer is On.

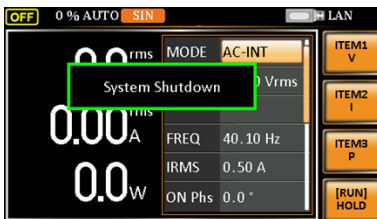

Input Detection: OFF
 Neither buzzer beep nor warning message will be shown when it detects input power abnormal regardless of Buzzer activation or not.

Example

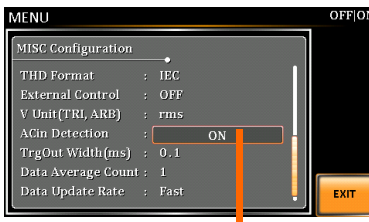

Acin Detection setting



Note

When “Power Input Anomaly” or “System Shutdown” message appears, it is Not available to operate any button or execute any SCPI command. Besides, SCPI Error message will be shown on the condition of System Error.

Trigger Out Width

This function, which is paired with External Control I/O pin, generates a TTL pulse signal output synchronously with output waveform.



Note

- When the set time of Pulse Width is greater than a period time of output frequency, output Pulse maintains High Level.
- The Trigger signal generates in 0 degrees only.
- This function can be executed under AC+DC mode, even DC Offset is configured.
- This function is Not available for DC-INT, AC+DC-EXT and AC-EXT modes.

Steps

1. Press the *Menu* key. The Menu setting will appear on the display. 
2. Use the scroll wheel to go to item 2, *MISC Configuration* and press *Enter*.
3. Go to the *TrgOut Width(ms)* setting using the scroll wheel and press *Enter*. Set the time and press *Enter* again to confirm.

TriOut Width 0.1 ~ 60.0 ms

Exit

4. Press *Exit[F4]* to exit from the MISC Configuration settings.



Example

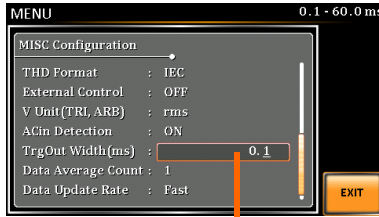

Trigger Out Width setting

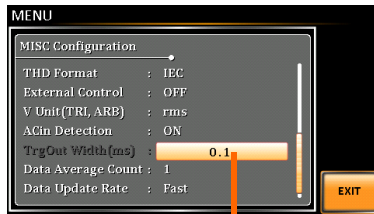

It is grey-out under unavailable modes, but value can be set still.

The actual waveform –
AC-INT Mode,
Frequency 900 Hz, TrgOut Width 0.1 ms



The actual waveform –
AC-INT Mode,
Frequency 900
Hz, TrgOut Width
1 ms



The actual waveform –
AC-INT Mode,
Frequency 900
Hz, TrgOut Width
1.1 ms

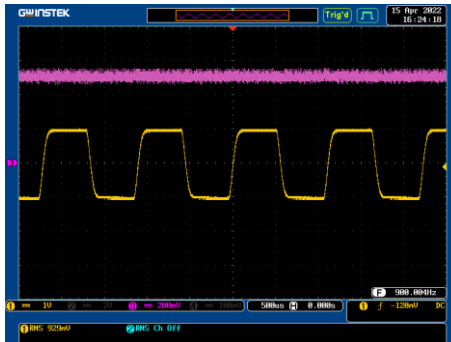

Data Average Count

This function allows user to designate an exact count number to average the measured data. It is particularly practical for large changes in load or power of low input signal frequency.

Steps

1. Press the *Menu* key. The Menu setting will appear on the display. 
2. Use the scroll wheel to go to item 2, *MISC Configuration* and press *Enter*.
3. Go to the *Data Average Count* setting using the scroll wheel and press *Enter*. Set the count number and press *Enter* again to confirm.

Data Average Count 1 - 128

Exit

4. Press *Exit[F4]* to exit from the MISC Configuration settings. 

Example

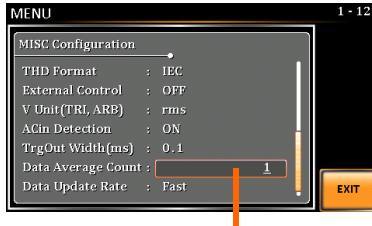

Data Average Count setting

Note

- The available parameters for Data Average Count: Vrms, Vmax, Vmin, Irms, Imax, Imin, PF, CF, P, S, Q.
- The Unavailable parameters for Data Average Count: Vavg, Iavg, IpkH, Freq, THDv, THDi.

Data Update Rate

This function allows user to define update rate (time period) for the measured data. Take the 5s for example, the measured data updates in an interval of every 5 second.

Steps

1. Press the *Menu* key. The Menu setting will appear on the display. 
2. Use the scroll wheel to go to item 2, *MISC Configuration* and press *Enter*.
3. Go to the *Data Update Rate* setting using the scroll wheel and press *Enter*. Set the rate period and press *Enter* again to confirm.

Data Update Rate	Fast/0.1s/0.25s/0.5s/1s /2s/5s/10s/20s
------------------	---

 **Note**

The option “Fast” indicates 0.005s equal to 5ms.

Exit

4. Press *Exit*[F4] to exit from the MISC Configuration settings. 

Example

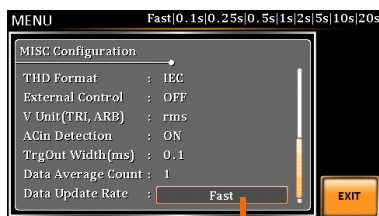

Data Update Rate setting

 **Note**

- The available parameters for Data Update Rate: Vrms, Vmax, Vmin, Irms, Imax, Imin, PF, CF, P, S, Q.
- The Unavailable parameters for Data Update Rate: Vavg, Iavg, IpkH, Freq, THDv, THDi.

T EST MODE FUNCTION

There are two test modes, Sequence Mode and Simulate Mode respectively, available for user to execute. Refer to the following chapters for details in necessity.

Sequence Mode	152
Sequence Mode Overview.....	152
Sequence Settings.....	157
Save a Sequence to Local Memory	162
Recall a Sequence from Local Memory.....	162
Manage Sequence Settings.....	163
Running a Sequence	165
Simulate Mode	169
Simulate Mode Overview	169
Simulate Settings	172
Save a Simulation to Local Memory	176
Recall a Simulation from Local Memory	176
Manage Simulation Settings	177
Running a Simulation	180

Sequence Mode

Sequence Mode Overview

Background

The Sequence function works with DC-INT, AC-INT and AC+DC-INT modes with full AC waveforms containing sine, square, triangle as well as arbitrary. The available parameters, which will be introduced in later sectors, vary depending on selected output modes.

A Sequence function is comprised of up to the maximum 999 steps.

Setting Screen Overview

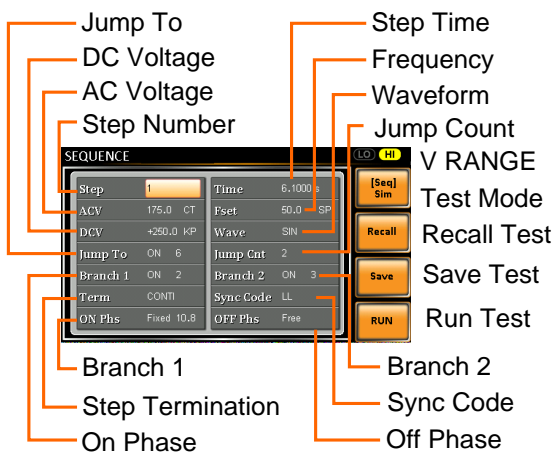

Sequence Parameter Overview

The Sequence function is comprised of a minimum of 2 steps that are executed in user defined sequences.

Each step can have different step time, voltage level, start & stop phase, frequency and wave.



Step 0 is assigned as a “Standby” step. At the end of the test the unit will shift to the standby step.

Step	Assigns the step number.
Time	Sets the step duration time. This step time is exclusive of any transition time needed to match start phases and stop phase. See the diagram on page 156 for details.
ACV	<p>Sets the AC voltage level. There are 3 secondary voltage settings that determine how the voltage is output.</p> <p>CT: Sets the voltage level of the step immediately to ACV values.</p> <p>KP: Sets the voltage level to “keep” the voltage of the previous step.</p> <p>SP: Linearly increases or decreases the values from the end of the previous step to the end of the current step.</p>



Note

It is available for AC+DC-INT and AC-INT modes only.

DCV	<p>Sets the DC voltage level. There are 3 secondary voltage settings that determine how the voltage is output.</p> <p>CT: Sets the voltage level of the step immediately to DCV values.</p> <p>KP: Sets the voltage level to “keep” the voltage of the previous step.</p> <p>SP: Linearly increases or decreases the values from the end of the previous step to the end of the current step.</p>
-----	---



Note

It is available for AC+DC-INT and DC-INT modes only.

AC/DC Voltage Range (ACV/DCV)	There are 2 voltage range settings: HI 200V & LO 100V, which result in varied ranges of ACV and DCV values, respectively.
Fset (Frequency)	<p>Sets the frequency of the step. There are 3 secondary frequency settings that determine how the frequency is output.</p> <p>CT: Sets the frequency level of the step immediately to Fset values.</p> <p>KP: Sets the frequency level to “keep” the frequency of the previous step.</p> <p>SP: Linearly increases or decreases the frequency from the end of the previous step to the end of the current step.</p>



Note

It is available for AC+DC-INT and AC-INT modes only.

Wave	Sets the outputting waveform of the step. Up to 4 waves including sine, square, triangle and arbitrary (1-16) wave shapes are available.
------	--



Note

It is available for AC+DC-INT and AC-INT modes only.

Jump To	The Jump To setting determines which step to jump to at the end of the step. If Jump To is turned off, the unit will follow the Term (Step termination) setting for the step.
Jump Cnt	Determines the number of times to loop the jump step.

Branch1/ Branch2	The Branch settings allow you to make a selectable branch within the sequence when the sequence is running or on hold. The branch1 or branch2 actions are enabled by pressing the <i>F1</i> or <i>F2</i> function keys, or by using the :TRIG:SEQ:SEL:EXEC remote control command. After the branch step(s) have completed the unit will return back to the step from which the branch was executed and continue to run the step from where it left off.
Term (Termination)	Determines the step termination settings at end of the step. The CONTI setting tells the sequence to go to the next step. The HOLD setting will pause the output at the end of the step and will only continue to the next step when CONTI [F3] is pressed. The END setting will end the sequence and go to Step 0(standby step).
Sync Code	Sets the synchronous code including LL, LH, HL and HH for each step.
ON/OFF Phs	Sets the start and stop phase of the AC waveform for each step. The ON Phs setting sets the starting phase <i>of the step</i> . OFF Phs sets the off phase <i>for the output</i> when the output if turned off.



Note

It is available for AC+DC-INT and AC-INT modes only.

Sequence Example

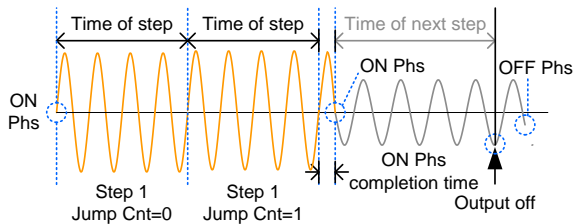

Process Flow in Sequence Step

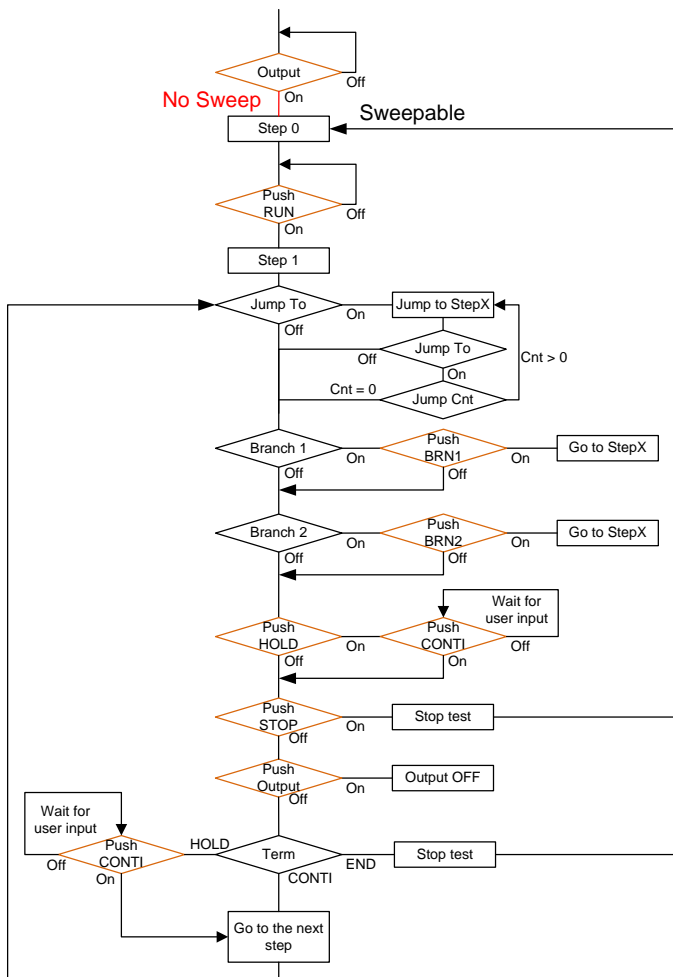



Note

The Remote Sense will be forcibly set OFF and Slew Rate Mode is set to time after entering the SEQ Mode. It will automatically return to the previous setting after exiting from the SEQ Mode.

Sequence Settings

Entering the Sequence Menu

1. Press *Test* key.

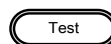

Alternatively, it is available to navigate, with scroll wheel, to the *TEST SEQ...* option followed by pressing the *Enter* key to enter the *SEQUENCE* menu.



Note

It is available for AC+DC-INT, AC-INT and DC-INT modes only.

2. Press *Seq/Sim[F1]* key to toggle to the *SEQUENCE* Mode.

Sequence Mode



F1 soft-key



Note

It is available for AC+DC-INT mode only.

Steps

3. Use the scroll wheel to go to the *Step* setting and press *Enter*.
4. Use the scroll wheel to select the step number. 0 is always the starting step for the sequence.

Step 0 ~ 999

- Go to the *Time setting* and set the duration of the step.

Time 0.0001 ~ 999.9999s

- In order to adjust both ACV and DCV voltage range between HI and LO, it is required to set up outside of the SEQUENCE menu. Refer to the page 66 for details. The selected range will be shown on the top bar.

Range



Range LO - 100V, HI - 200V

- Go to the *ACV setting* and set the output voltage for the step. If you input an ACV value that is not within the voltage range, the warning message below will be shown.

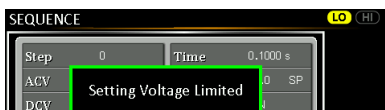

Next set the secondary voltage settings to determine characteristics of the voltage output.

ACV 0.0 ~ 350.0V (Range 200V)
0.0 ~ 175.0V (Range 100V)

Secondary settings CT (Constant), KP (Keep), SP (Sweep)

Note: Step 0 can only be set to either CT or SP.

- Go to the *DCV* setting and set the output voltage for the step. If you input a DCV value that is not within the voltage range, the warning message below will be shown.

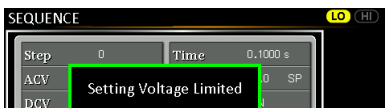

Next set the secondary voltage settings to determine characteristics of the voltage output.

DCV	0.0 ~ 500.0V (Range 200V)
	0.0 ~ 250.0V (Range 100V)

Secondary settings	CT (Constant), KP (Keep), SP (Sweep)
--------------------	--------------------------------------

 Note

Step 0 can only be set to either CT or SP.

 Note

ACV setting range varies when Wave is TRI or ARB1~16. The setting range is 0~500 Vpp or 0~1000 Vpp when V Unit is set p-p.

- Go to the *Fset* setting and set the frequency of the step. If you input a frequency value that is not within the range, the warning message below will be shown.

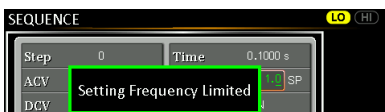

Fset	1.0 ~ 999.9Hz
------	---------------

Secondary settings	CT (Constant), KP (Keep), SP (Sweep)
--------------------	--------------------------------------

Note: Step 0 can only be set to either CT or SP.

- Go to the *Wave* setting and choose which waveform to output.

Wave	SIN, SQU, TRI, ARB1 - 16
------	--------------------------

11. Go to the *Jump To* setting and choose which step to jump to, or turn the setting off.

Step	ON, OFF, 0 ~ 999
------	------------------

12. Go to the *Jump Cnt* setting and set the number of times the current step will loop.

Jump Cnt	1 ~ 9999, 0
----------	-------------

Note: A setting of 0 will set the number of jump step to be infinite.

13. Go to the *Branch 1/2* setting and set a step to branch to.

Branch 1, 2	ON, OFF, 0 ~ 999
-------------	------------------

14. Go to the *Term* setting and set the step termination setting. CONTI will automatically go to the next step at the end of the step. END will return to step 0. HOLD will stay at the current step until you allow the sequence to continue to the next step.

Term	CONTI, END, HOLD
------	------------------

15. Go to the *Sync Code* setting and set the synchronous code when the step has started.

Sync Code	LL, LH, HL, HH
-----------	----------------

16. Go to the *ON Phs* setting and set the starting phase of the step. The *Fixed* indicates user-defined degree.

ON Phase	Free, Fixed
----------	-------------

ON Phase 0.0 ~ 359.9°

Resolution 0.1°

17. Go to the *OFF Phs* setting and set the end phase of the step. The *Fixed* indicates user-defined degree.

OFF Phase Free, Fixed

OFF Phase 0.0 ~ 359.9°

Resolution 0.1°

Example of Using Sequence Function

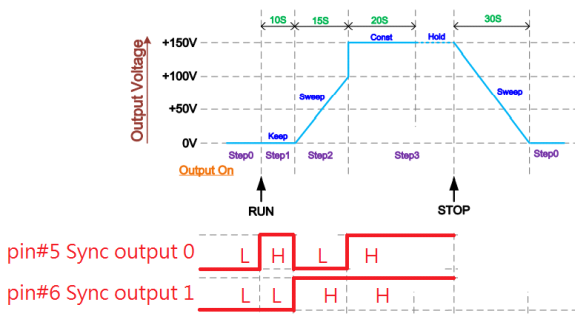

The example above shows how to generate a test procedure in DC-INT mode by each step.

Step No.	0	1	2	3
Step Time	30 S	10 S	15 S	20 S
DCV	0 V	50 V	100 V	150 V
2 nd Setting	SP	KP	SP	CT
Term	--	CONTI	CONTI	HOLD
Sync Code	LL	LH	HL	HH

Save a Sequence to Local Memory

Saving a Sequence

Sequence settings can be saved to one of 10 memory slots (SEQ0 ~ SEQ9).

Steps

1. Press *Save*[F3] key firstly.
2. A list of memory slots prompts where it is available to use scroll wheel followed by pressing *Enter* to execute save action.
3. A prompt message will appear when the save action is successful.

Save SEQ0 ~ SEQ9

Recall a Sequence from Local Memory

Recall a Sequence

Sequence settings can be recalled from one of 10 memory slots (SEQ0 ~ SEQ9).

Steps

1. Press *Recall*[F2] key firstly.
2. A list of memory slots prompts where it is available to use scroll wheel followed by pressing *Enter* to execute recall action.
3. A message will appear when the settings are recalled successfully.

Recall SEQ0 ~ SEQ9

Manage Sequence Settings

Sequence settings can be easily saved to or from a USB flash drive using the Save/Recall Files utility in the Menu system. Files can also be deleted from local memory using the utility.

File Format	<p>When files are saved to USB they are saved in the following format: SEQX.SEQ, where X is the memory number 0 ~ 9 (SEQ0 ~ SEQ9). The files are saved to USB:/gw.</p> <p>When files are recalled from USB, files must be recalled from the same memory number. For example, the file SEQ0.SEQ can only be recalled to memory number SEQ0. The files can only be recalled from the USB:/gw directory.</p>				
Steps	<ol style="list-style-type: none"> 1. Press the <i>Menu</i> key. The Menu settings will appear on the display.  2. Use the scroll wheel to go to item 10, <i>Save/Recall Files</i> and press <i>Enter</i>. 3. Go to the <i>Type</i> setting using the scroll wheel and press <i>Enter</i>. Select <i>SEQUENCE</i> and press <i>Enter</i> to confirm. 4. Go to the <i>Action</i> setting and choose the file operation and then press <i>Enter</i>. <hr/> <table border="0" style="width: 100%;"> <tr> <td style="width: 20%; vertical-align: top;">MEM→USB</td> <td>Saves the selected sequence memory from the local memory to a USB flash drive.</td> </tr> <tr> <td style="vertical-align: top;">MEM←USB</td> <td>Loads the sequence memory from a USB flash drive to the selected local memory.</td> </tr> </table> <hr/>	MEM→USB	Saves the selected sequence memory from the local memory to a USB flash drive.	MEM←USB	Loads the sequence memory from a USB flash drive to the selected local memory.
MEM→USB	Saves the selected sequence memory from the local memory to a USB flash drive.				
MEM←USB	Loads the sequence memory from a USB flash drive to the selected local memory.				

Delete	Deletes (Recall Default) the selected sequence memory from local memory.
--------	--

5. Go to the *Memory No.* setting and select the sequence memory number to perform the operation on. Press *Enter* to confirm.

Memory No.	0 ~ 9 (SEQ0 ~ SEQ9)
------------	---------------------

Execute File Operation

6. Press *EXE*[F1] key to perform the file operation.



Exit

7. Press *EXIT*[F4] key to exit from the *Save/Recall Files* settings.



Example

Load file from USB to Local memory

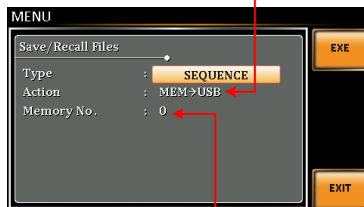

Memory No. 0 selected

All Data Operation

8. Go back to the *Type* setting using the scroll wheel and press *Enter*. Select *All Data* and press *Enter* to confirm.

9. Go to the *Action* setting and choose the file operation and then press *Enter*.

MEM->USB	Saves all the files including Preset, Sequence, Simulate and ARB from the local memory to a USB flash drive.
----------	--

MEM←USB	Loads all the files including Preset, Sequence, Simulate and ARB from a USB flash drive to the local memory.
Delete	Deletes (Recall Default) all the files including Preset, Sequence, Simulate and ARB from local memory.

Example

All Data option selected

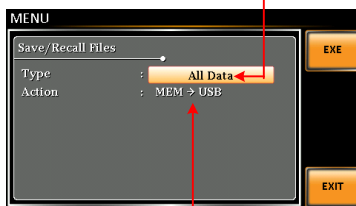

Save all data from Local memory to USB

Default Sequence Setting

SEQ6 Momentary drop in supply voltage

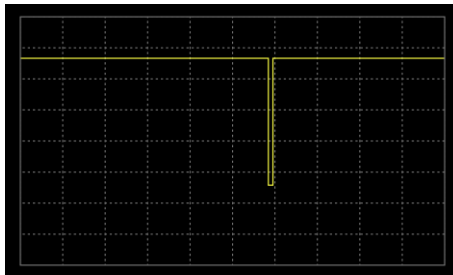

SEQ7 Reset test for Level1 systems with 12V

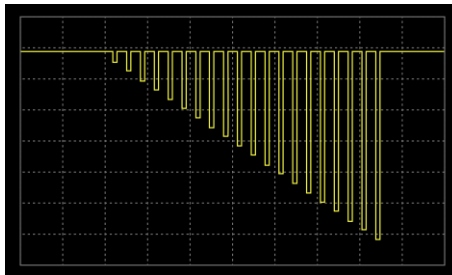

SEQ8 Starting Profile

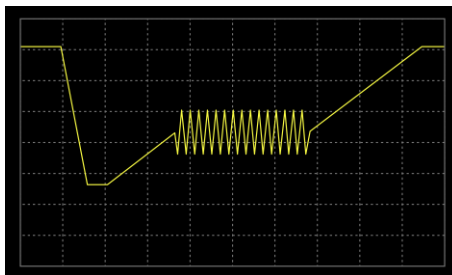

SEQ9 Test2 Tr: 10ms, Td: 40ms

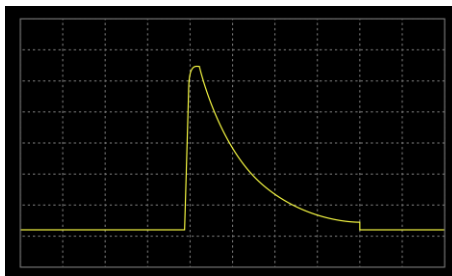

Note

Only FW version V1.07 above can support the above default waveform.

Running a Sequence

Background When running a sequence, the display changes to the sequence run view.

Run Screen Overview

Settings

Readback measurements

Steps

1. Press *Output*. 
2. Press *RUN[F4]* key. The test will start to run.

The settings of current step will be shown at the top of the screen and the measurement readout will be shown on the bottom of the screen.

The top-right of the screen will display the current step number by the total number of steps (current step/total steps).

3. The test will continue to run until the last step has run, or *Stop[F4]* key is pressed. When the test has finished/stopped, the screen will return to the original settings screen.
4. If any of the steps have a conditional branch configured, the branch can be manually evoked during run time by pressing the *BRN1[F1]* soft-key (branch 1) or the *BRN2[F2]* soft-key (branch 2). Alternatively the `:TRIG:SEQ:SEL:EXEC` command can also be used evoke a conditional

branch.

Hold Test 5. To pause the test mid-way, press *HOLD*[F3] key.

Continue Test 6. To continue a paused test, press *CONTI*[F3] key.

Simulate Mode

Simulate Mode Overview

Background The Simulate function, which works in AC+DC-INT mode only, is used to test power supply fluctuation. This function is able to simulate common abnormalities in mains power such as fluctuations in voltage, phase and frequency. These simulations can be run as one-off anomalies or cyclic anomalies.

Setting Screen Overview

The screenshot shows the SIMULATE test mode interface. At the top, a waveform graph displays a sine wave with various segments labeled: 'Init', 'Normal1', 'Trans1', 'Abnormal', 'Trans2', 'Normal2', and 'Init'. Below the graph is a control panel with the following fields and buttons:

- Step:** Normal 2
- Time:** 0.1000 s
- Repeat:** ON 2
- ACV:** 0.0
- ON Phs Free:** ON 2
- Fset:** 50.0
- OFF Phs Free:** OFF
- Wave:** SIN
- Code:** LL

On the right side of the screen, there are several buttons: 'Seq [Sim]', 'Recall', 'Save', and 'RUN'. A legend on the right side of the image maps these elements to their functions:

- V RANGE:** (points to the top right corner)
- Test Mode:** (points to the 'Seq [Sim]' button)
- Recall Test:** (points to the 'Recall' button)
- Save Test:** (points to the 'Save' button)
- Run Test:** (points to the 'RUN' button)
- Number of Repeat:** (points to the 'Repeat' field)
- Step Time:** (points to the 'Time' field)
- ON/OFF Phase:** (points to the 'ON Phs Free' and 'OFF Phs Free' fields)
- Sync Code:** (points to the 'Code' field)
- Step Wave:** (points to the 'Wave' field)
- Step Frequency:** (points to the 'Fset' field)
- Step Voltage:** (points to the 'ACV' field)
- Step:** (points to the 'Step' field)

Step Overview

The Simulate function is comprised of 6 steps. Each step is run sequentially in the following order: Initial, Normal1, Trans1, Abnormal, Trans2, Normal2 and Initial.

- Initial** The Initial step is used as the initial and final settings of the waveform simulation. This is the standby step before the test starts and the standby step after the test ends.
- Normal1** This step configures the normal output conditions that precede the abnormal conditions.

Trans1	This step configures the transition from normal to abnormal conditions. This step will linearly interpolate the normal settings to the abnormal settings. This step can be skipped for abrupt state changes.
Abnormal	This step contains the abnormal conditions for the simulation.
Trans2	This step configures the transition from abnormal to normal conditions.
Normal2	This step configures the normal conditions that supersede the abnormal conditions.

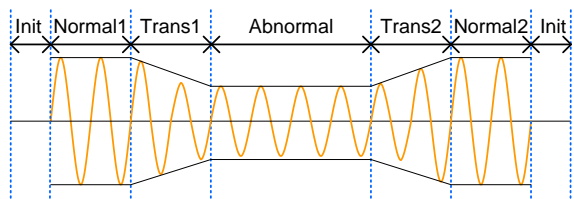

Parameter Overview

The following table shows which parameters are available for each step.

Step\Parameter	Initial	Normal1	Trans1	Abnormal	Trans2	Normal2
Time	X	✓	✓	✓	✓	✓
ACV	✓	✓	X	✓	X	X
ON Phs	✓	✓	X	✓	X	✓
Fset	✓	✓	X	✓	X	X
OFF Phs	✓	✓	X	✓	X	✓
Wave	✓	✓	X	✓	X	X
Code	✓	✓	✓	✓	✓	✓
Repeat	✓	✓	✓	✓	✓	✓

Time	Sets the duration time of the step. When the ON Phs=ON, the total duration of the step is equal to the Time setting + ON Phs=ON duration.
ACV	Sets the voltage of the step. Not applicable for the Trans 1/2 steps and the Normal2 step.
ON Phs	Sets the starting phase of the waveform for the step. Not applicable for the Trans 1/2 steps.
Fset	Sets the frequency of the step. Not applicable for the Trans 1/2 steps and the Normal2 step.
OFF Phs	Sets the off phase of the waveform after the output has been turned off. Not applicable for the Trans 1/2 steps.
Wave	Sets the outputting waveform of the step. Not applicable for the Trans 1/2 steps and the Normal2 step.
Code	Sets the synchronous code including LL, LH, HL and HH for the duration of the step.
Repeat	Indicates the number of times the simulation will be run, from Normal1 to Normal2. A value of 0 indicates infinite repeats. The repeat setting is the same for each step.

The following diagram illustrates the relationship between each of the parameters in a step.

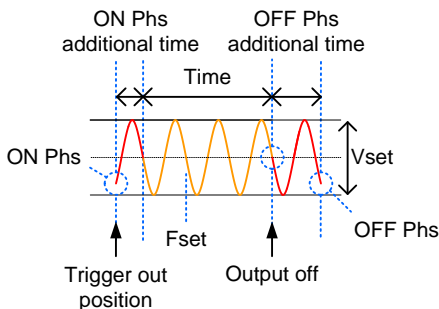

Note After entering the SIM Mode, It will forcibly set Remote Sense OFF and Time Slew Rate.

Simulate Settings

Entering the Simulate Menu

1. Press *Test* key.

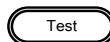

Alternatively, it is available to navigate, with scroll wheel, to the *TEST SIM...* option followed by pressing the *Enter* key to enter the *SIMULATE* menu.



It is available for AC+DC-INT mode only.

2. Press *Seq/Sim[F1]* key to toggle to the *SIMULATE* Mode.

Simulate Mode

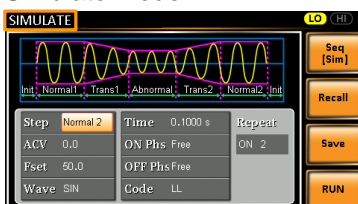

F1 soft-key

- Steps
3. Use the scroll wheel to go to the *Step* setting and press *Enter*.
 4. Use the scroll wheel to select one of the simulate steps and press *Enter*.

Steps	Initial, Normal1, Trans1, Abnormal, Trans2, Normal2
-------	---

5. Go to the *Time* setting and set the duration of the step.

Time	0.0001 ~ 999.9999s (Normal1, Normal2 and Abnormal) 0.0000 ~ 999.9999s (Trans1 and Trans2)
------	--

Note: For Trans1 and Trans2, it supports a value of 0, which will skip the step.

6. In order to adjust ACV voltage range between HI and LO, it is required to set up outside of the SIMULATE menu. Refer to the page 66 for details. The selected range will be shown on the top bar.

Range

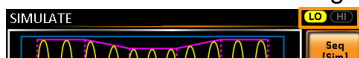

Range	LO - 100V, HI - 200V
-------	----------------------

- Go to the *ACV* setting and set the *Vrms* level of the step. If you input an *ACV* value that is not within the voltage range, the warning message below will be shown.

Not applicable for *Trans1*, *Trans2* and *Normal2*.

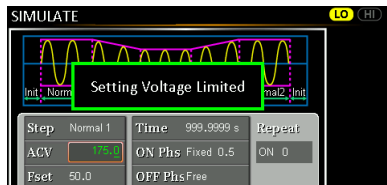

<i>ACV</i>	0.0 ~ 350.0V (Range 200V)
	0.0 ~ 175.0V (Range 100V)

- Go to the *ON Phs* setting and set the starting phase of the step.

Not applicable for *Trans1* and *Trans2*.

<i>ON Phase</i>	Free, Fixed
-----------------	-------------

<i>ON Phase</i>	0.0 ~ 359.9°
-----------------	--------------

<i>Resolution</i>	0.1°
-------------------	------

- Go to the *Fset* setting set the frequency of step. If you input a frequency value that is not within the range, the warning message below will be shown.

Not applicable for *Trans1*, *Trans2* and *Normal2*.

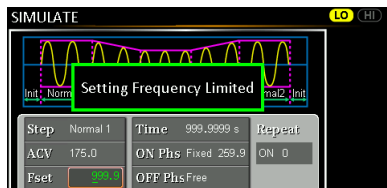

<i>Fset</i>	1.0 ~ 999.9Hz
-------------	---------------

10. Go to the *OFF Phs* setting and set the end phase of the step.

Not applicable for Trans1 and Trans2.

OFF Phase Free, Fixed

OFF Phase 0.0 ~ 359.9°

Resolution 0.1°

11. Go to the *Wave* setting and set the wave of step.

Not applicable for Trans1, Trans2 and Normal2.

Wave SINE

12. Go to the *Code* setting and set the synchronous code of the step.

Code LL, LH, HL, HH

13. Lastly, go to the *Repeat* parameter select the number of times the simulation will repeat the Normal1-Trans1-Abnormal-Trans2-Normal2 sequence of steps. A value of 0 will set the number of repetitions to infinite.

Repeat 1 ~ 9999, 0(infinite)

Save a Simulation to Local Memory

Saving a Simulation	Simulation settings can be saved to one of 10 memory slots (SIM0 ~ SIM9).		
Steps	<ol style="list-style-type: none">1. Press <i>Save</i>[F3] key firstly.2. A list of memory slots prompts where it is available to use scroll wheel followed by pressing <i>Enter</i> to execute save action.3. A prompt message will appear when the save action is successful.		
	<hr/> <table><tr><td>Save</td><td>SIM0 ~ SIM9</td></tr></table>	Save	SIM0 ~ SIM9
Save	SIM0 ~ SIM9		

Recall a Simulation from Local Memory

Recall a Simulation	Simulation settings can be recalled from one of 10 memory slots (SIM0 ~ SIM9).		
Steps	<ol style="list-style-type: none">1. Press <i>Recall</i>[F2] key firstly.2. A list of memory slots prompts where it is available to use scroll wheel followed by pressing <i>Enter</i> to execute recall action.3. A message will appear when the settings are recalled successfully.		
	<hr/> <table><tr><td>Recall</td><td>SIM0 ~ SIM9</td></tr></table>	Recall	SIM0 ~ SIM9
Recall	SIM0 ~ SIM9		

Manage Simulation Settings

Simulation settings can be easily saved to or from a USB flash drive using the Save/Recall Files utility in the Menu system. Files can also be deleted from local memory using the utility.

File Format When files are saved to USB they are saved in the following format:
SIMX.SIM, where X is the memory number 0 ~ 9 (SIM0 ~ SIM9). The files are saved to USB:/gw.

When files are recalled from USB, files must be recalled from the same memory number. For example, the file sim0.sim can only be recalled to memory number SIM0. The files can only be recalled from the USB:/gw directory.

Steps

1. Press the *Menu* key. The Menu settings will appear on the display. 
2. Use the scroll wheel to go to item 10, *Save/Recall Files* and press *Enter*.
3. Go to the *Type* setting using the scroll wheel and press *Enter*. Select *SIMULATE* and press *Enter* to confirm.
4. Go to the *Action* setting and choose the file operation and then press *Enter*.

MEM→USB Saves the selected simulation memory from the local memory to a USB flash drive.

MEM←USB Loads the simulation memory from a USB flash drive to the selected local memory.

Delete	Deletes (Recall Default) the selected simulation memory from local memory.
--------	--

- Go to the *Memory No.* setting and select the simulation memory number to perform the operation on. Press *Enter* to confirm.

Memory No.	0 ~ 9 (SIM0 ~ SIM9)
------------	---------------------

Execute File Operation

- Press *EXE[F1]* key to perform the file operation.



Exit

- Press *EXIT[F4]* key to exit from the *Save/Recall Files* settings.



Example

Load file from USB to Local memory

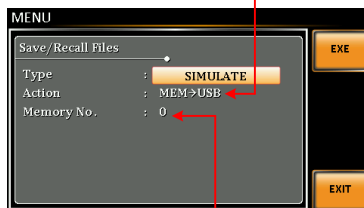

Memory No. 0 selected

All Data Operation

- Go back to the *Type* setting using the scroll wheel and press *Enter*. Select *All Data* and press *Enter* to confirm.
- Go to the *Action* setting and choose the file operation and then press *Enter*.

MEM->USB	Saves all the files including Preset, Sequence, Simulate and ARB from the local memory to a USB flash drive.
----------	--

MEM←USB	Loads all the files including Preset, Sequence, Simulate and ARB from a USB flash drive to the local memory.
Delete	Deletes (Recall Default) all the files including Preset, Sequence, Simulate and ARB from local memory.

Example

All Data option selected

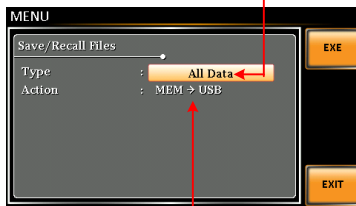

Save all data from
Local memory to USB

Running a Simulation

Background When running a simulation, the display changes to the simulate run view.

Run Screen Overview

Settings

The screenshot shows a 'SIMULATE' screen with the following layout:

- Top right: Step X of Y (3 / 5)
- Settings section:

ACV	0.3 Vrms	WAVE	SIN
FREQ	50.0 Hz	
- Readback measurements section:

V	0.5	Vrms	S	0.0	VA
I	0.01	Arms	PF	0.316	
P	0.0	W	CF	1.52	
- Control buttons:
 - HOLD (orange button): HOLD/CONTI test
 - STOP (yellow button): STOP/RUN test

Readback measurements

Steps

1. Press *Output* key.



2. Press *Run[F4]* key. The test will start to run.

The settings of current step will be shown at the top of the screen and the measurement readout will be shown on the bottom of the screen.

The top-right of the screen will display the current step number of the simulation.

- | | |
|----------------|--------------|
| 1/5 = Normal1 | 2/5 = Trans1 |
| 3/5 = Abnormal | 4/5 = Trans2 |
| 5/5 = Normal2 | |

3. The test will continue to run until the last repeat step has run, or *Stop[F4]* key is pressed or the output is turned off*. When the test has finished/stopped, the screen will return to the original settings screen.

* If the OFF-phase has been set, the output will continue until the OFF-phase setting is satisfied.

Hold Test

4. To pause the test mid-way, press *HOLD[F3]* key.

Continue Test

5. To continue a paused test, press *CONTI[F3]* key.

C OMMUNICATION

I NTERFACE

This chapter describes basic configuration of IEEE488.2 based remote control. For a command list, refer to the programming manual, downloadable from GW Instek website, www.gwinstek.com



Note

If the instrument is remotely controlled via the USB/LAN/RS232/GPIB interface, the panel lock is automatically enabled.

Interface Configuration	183
Configure Ethernet Connection.....	183
USB Remote Interface	184
USB Remote Control Function Check	185
RS232 Remote Interface	186
RS232 Remote Control Function Check	188
Using Realterm to Establish a Remote Connection	189
GPIB Remote Interface (ASR-GPIB-2K Option)	192
GPIB Function Check	193
Web Server Remote Control Function Check.....	196
Socket Server Function Check.....	197



Interface Configuration

Configure Ethernet Connection

The Ethernet interface can be configured for a number of different applications. Ethernet can be configured for basic remote control or monitoring using a web server or it can be configured as a socket server.

The ASR-2000 supports both DHCP connections so the instrument can be automatically connected to an existing network or alternatively, network settings can be manually configured.

Ethernet Parameters	MAC Address (display only)	DHCP
	IP Address	Subnet mask
	Gateway	DNS address
	DNS Server	Socket port fixed at 2268

Ethernet Configuration	1. Connect a LAN cable from the PC to the Ethernet port on the rear panel.	
	2. Press the <i>Menu</i> key. The Menu setting will appear on the display.	
	3. Use the scroll wheel to go to item 3, LAN and press <i>Enter</i> .	
	4. If the LAN cable is installed correctly a connection is active, the <i>Connection Status</i> will show <i>Online</i> .	
	5. To automatically have the network assign an IP address, set DHCP to ON. Otherwise set DHCP to OFF to manually set the Ethernet settings.	
	DHCP	ON, OFF

- If DHCP was set to OFF, configure the remaining LAN parameters.

IP Address

Subnet Mask

Gateway

DNS Server

Socket Port



Note

Socket Port is fixed to 2268.

LAN configuration - 1

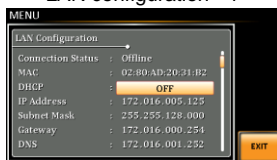

LAN configuration - 2



Exit

- Press *Exit*[F4] to exit from the LAN settings.





USB Remote Interface

USB Configuration	PC side connector	Type A, host
	ASR-2000 side connector	Rear panel Type B, device
	Speed	1.1/2.0 (full speed)
	USB Class	CDC (communications device class)

Steps

- Connect the Type A-Type B USB cable from the PC to the rear panel USB B port.



2. Press the *Menu* key. The Menu setting will appear on the display. 
 3. Use the scroll wheel to go to item 4, *USB Device*.
 4. If the connection is successful *Connection Status* will change from Offline to Online.
- Exit
5. Press *Exit[F4]* to exit from the rear panel USB settings. 

USB Remote Control Function Check

Functionality Check

Invoke a terminal application such as Realterm. ASR-2000 will appear as a COM port on the PC.

To check the COM settings in Windows, see the Device Manager. For example, in Win7 go to the Control panel → System → Hardware tab.

Note

If you are not familiar with using a terminal application to send/receive remote commands via a USB connection, please see page 189 for more information.

Run this query command via the terminal after the instrument has been configured for USB remote control (page 184).

*IDN?

This should return the Manufacturer, Model number, Serial number, and Software version in the following format.

GW-INSTEK, ASR-2XXX, GXXXXXXXXX, XX.XX

Manufacturer: GW-INSTEK

Model number : ASR-2XXX

Serial number : GXXXXXXXXX

Software version : XX.XX



Note

For further details, please see the programming manual, available on the GW Instek web site @ www.gwinstek.com.

RS232 Remote Interface

RS232 Configuration	Connector	BD-9, male
	Parameters	Baud rate, data bits, parity, stop bits.

Pin Assignment		2: RxD (Receive data) 3: TxD (Transmit data) 5: GND 4, 6 ~ 9: No connection
----------------	--	--

Pin Connection Use a Null Modem connection (RS232C cable) as shown in the diagram below.

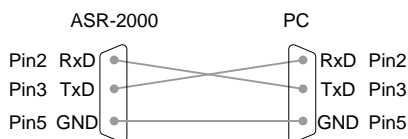

Steps

1. Connect the RS232C cable from the PC to the rear panel RS232 port.

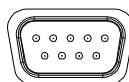

2. Press the *Menu* key. The Menu setting will appear on the display.



3. Use the scroll wheel to go to item 5, RS232C and press *Enter*.

4. Set the RS232C relative settings.

Baud rate	1200, 2400, 4800, 9600(default), 19200, 38400, 57600, 115200,
Data bits	7 bits, 8 bits(default)
Parity	None(default), Odd, Even
Stop bits	1 bit(default), 2 bits

RS232C Configuration



Exit

5. Press *Exit*[F4] to exit from the RS232C settings.



The ASR Standard accessory does Not include RS232 data cable. Please purchase the additional GTL-232 which will meet your need for RS232 connection.

RS232 Remote Control Function Check

Functionality
Check

Invoke a terminal application such as Realterm.
For RS232, set the COM port, baud rate, stop bit, data bit and parity accordingly.

To check the COM settings in Windows, see the Device Manager. For example, in Win7 go to the Control panel → System → Hardware tab.



If you are not familiar with using a terminal application to send/receive remote commands from the serial port, please see page 189 for more information.

Run this query command via the terminal after the instrument has been configured for RS232 remote control (page 186).

*IDN?

This should return the Manufacturer, Model number, Serial number, and Software version in the following format.

GW-INSTEK, ASR-2XXX, GXXXXXXXX, XX.XX

Manufacturer: GW-INSTEK

Model number : ASR-2XXX

Serial number : GXXXXXXXX

Software version : XX.XX



For further details, please see the programming manual, available on the GW Instek web site @ www.gwinstek.com.

Using Realterm to Establish a Remote Connection

Background Realterm is a terminal program that can be used to communicate with a device attached to the serial port of a PC or via an emulated serial port via USB.

The following instructions apply to version 2.0.0.70. Even though Realterm is used as an example to establish a remote connection, any terminal program can be used that has similar functionality.



Note

Realterm can be downloaded on Sourceforge.net free of charge.

For more information please see
<http://realterm.sourceforge.net/>

- Operation**
1. Download Realterm and install according to the instructions on the Realterm website.
 2. Connect the ASR-2000 via USB (page 183) or via RS232 (page 185).
 3. If using RS232, make note of the configured baud rate, stop bits and parity.
 4. Go to the Windows device manager and find the COM port number for the connection. For example, go to the Start menu > Control Panel > Device Manager.

Double click the *Ports* icon to reveal the connected serial port devices and the COM port for the each connected device.

If using USB, the baud rate, stop bit and parity settings can be viewed by right-clicking the connected device and selecting the *Properties*

option.

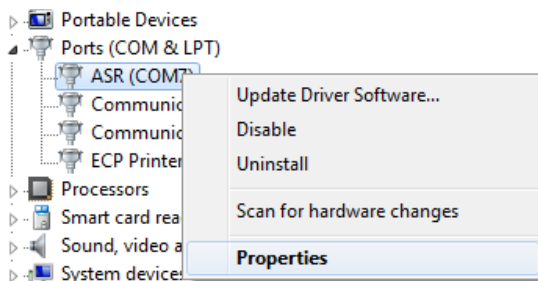

5. Start Realterm on the PC as an administrator.
Click:
Start menu>All Programs>RealTerm>realterm

Tip: to run as an administrator, you can right click the Realterm icon in the Windows Start menu and select the *Run as Administrator* option.

6. After Realterm has started, click on the *Port* tab.

Enter the *Baud*, *Parity*, *Data bits*, *Stop bits* and *Port* number configuration for the connection.

The *Hardware Flow Control*, *Software Flow Control* options can be left at the default settings.

Press *Open* to connect to the ASR-2000.

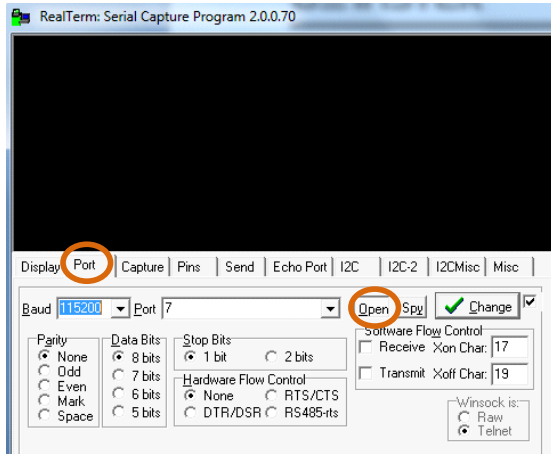

For USB, the baud rate should be fixed to 115,200.

7. Click on the *Send* tab.

In the *EOL* configuration, check on the *+LF* check boxes.

Enter the query:
**idn?*

Click on *Send ASCII*.

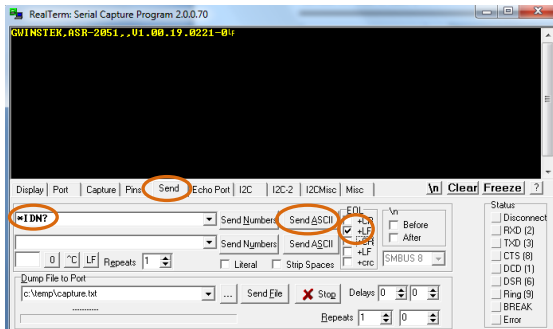

8. The terminal display will return the following:

 GW-INSTEK, ASR-2XXX, GXXXXXXXXX, XX.XX
 (manufacturer, model, serial number, software version)
9. If Realterm fails to connect to the ASR-2000, please check all the cables and settings and try again.

GPIB Remote Interface (ASR-GPIB-2K Option)

GPIB Configuration

1. Connect a GPIB cable from the PC to the GPIB port on the rear panel.

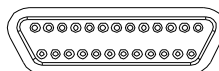

2. Press the *Menu* key. The Menu setting will appear on the display.



3. Use the scroll wheel to go to item 6, *GPIB* and press *Enter*.
4. Set the GPIB address.

GPIB Address 0 ~ 30 (10 by default)

GPIB Configuration

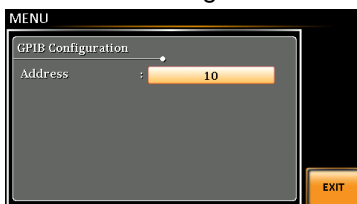

 **Note**

Only one GPIB address can be used at a time.

Exit 5. Press *Exit*[F4] to exit from the GPIB settings. 

- GPIB Constraints
- Maximum 15 devices altogether, 20m cable length, 2m between each device
 - Unique address assigned to each device
 - At least 2/3 of the devices turned On
 - No loop or parallel connection

 **Note** The ASR-GPIB-2K Option does Not include GPIB data cable. Please purchase the additional GTL-258 which will meet your need for GPIB connection.

GPIB Function Check

Functionality Check Please use the National Instruments Measurement & Automation Controller software to confirm GPIB/LAN functionality.

See the National Instrument website, <http://www.ni.com> for details.

 **Note**

- For further details, please see the programming manual, available on the GW Instek web site @ www.gwinstek.com
- Operating System: Windows XP, 7, 8, 10

Operation 1. Start the NI Measurement and Automation Explorer (MAX) program. Using Windows, press: 

Start>All Programs>NI MAX

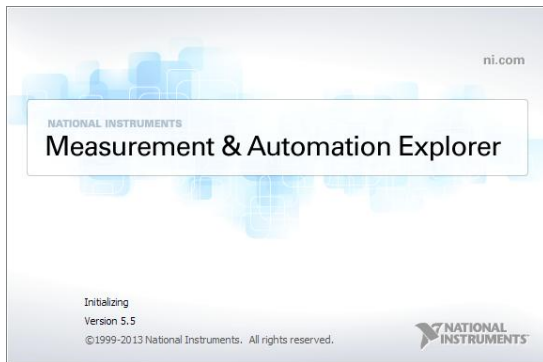

2. From the Configuration panel access;
My System>Devices and Interfaces>GPIB0
3. Press the *Scan for Instruments* button.
4. In the *Connected Instruments* panel the ASR-2000 should be detected as *Instrument 0* with the address the same as that configured on the ASR-2000.
5. Double click the *Instrument 0* icon.

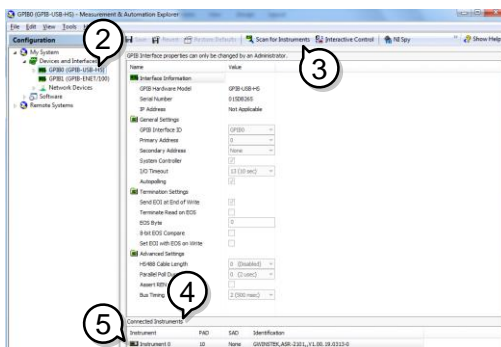

6. Click on *Communicate with Instrument*.
7. Under the Communicator tab, ensure **IDN?* is written in the *Send String* text box.
8. Click on the *Query* button to send the **IDN?* query to the instrument.
9. The instrument identification string will be returned to the buffer area:

GW-INSTEK, ASR-2XXX, GXXXXXXXX, XX.XX
(manufacturer, model, serial number, software version)

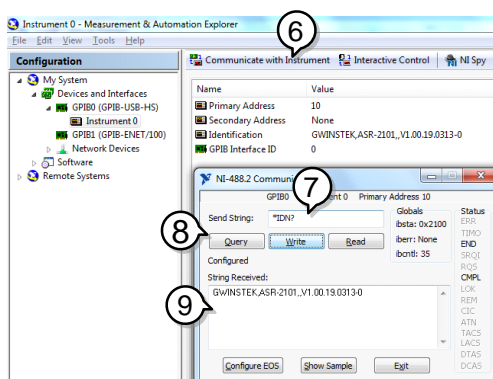

10. The function check is complete.

Web Server Remote Control Function Check

Functionality Check

Enter the IP address of the power supply (for example: http:// XXX.XXX.XXX.XXX) in a web browser after the instrument has been configured for LAN (page 183).

The web interface allows you to:

- View the system and information and the network configuration.
- View the analog control pinout.
- View the dimensions of the unit.
- View the operating area

Example:

The screenshot shows the GW INSTEK web interface. At the top, there is the GW INSTEK logo with the tagline "Simply Reliable" and a "Visit Our Site" link. To the right, there are links for "Support" and "Contact Us". Below the header, there are several sections:

- Welcome Page**: A simple text label.
- Network Configuration**: A section with four input fields:
 - IP Address: 172.16.5.125
 - Subnet Mask: 255.255.128.0
 - Gateway: 172.16.0.254
 - DNS: 172.16.1.252
- Analog Control**: A section with a "DHCP State" option, where "ON" is selected with a radio button and "OFF" is unselected.
- Figure of Dimensions**: A section with a "Password:" label and an empty input field.
- Operating Area**: A section with a "Submit" button.

Socket Server Function Check

Background To test the socket server functionality, National Instruments Measurement and Automation Explorer can be used. This program is available on the NI website, www.ni.com, via a search for the VISA Run-time Engine page, or “downloads” at the following URL, <http://www.ni.com/visa/>

Requirements Operating System: Windows XP, 7, 8, 10

Functionality Check 1. Start the NI Measurement and Automation Explorer (MAX) program. Using Windows, press:

Start>All Programs>NI MAX



2. From the Configuration panel access;

My System>Devices and Interfaces>Network Devices

3. Press *Add New Network Device>Visa TCP/IP Resource...*

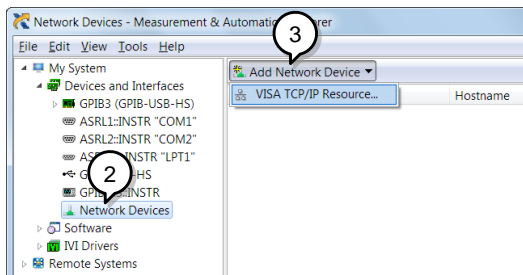

4. Select *Manual Entry of Raw Socket* from the popup window.

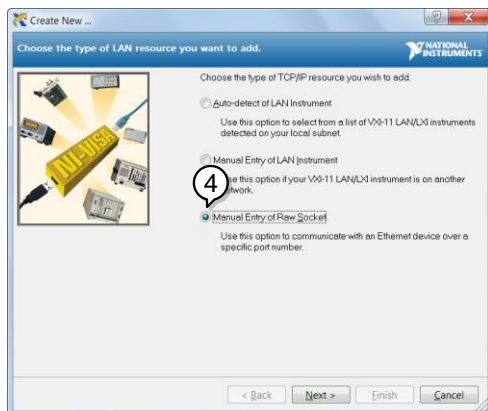

5. Enter the IP address and the port number of the ASR-2000. The port number is fixed at 2268.
6. Double click the Validate button and press *Next*.

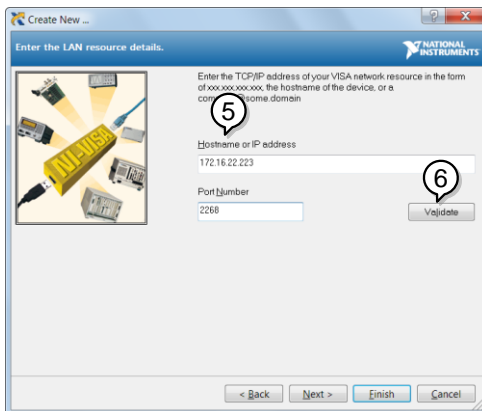

7. Next configure the Alias (name) of the ASR-2000 connection. In this example the Alias is: ASR
8. Click finish.



9. The IP address of the power supply will now appear under Network Devices in the configuration panel. Select this icon now.
10. Press *Open VISA Test Panel*.

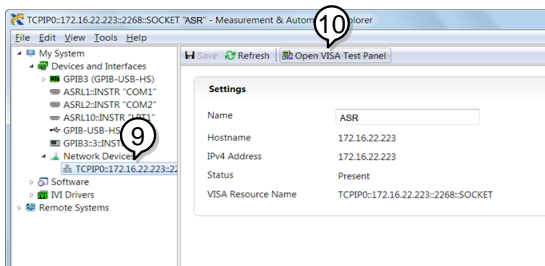

11. Click the *Configuration* Icon. Under the *IO Settings* tab check *Enable Termination Character*. The termination character should be set as *Line Feed - \n*.

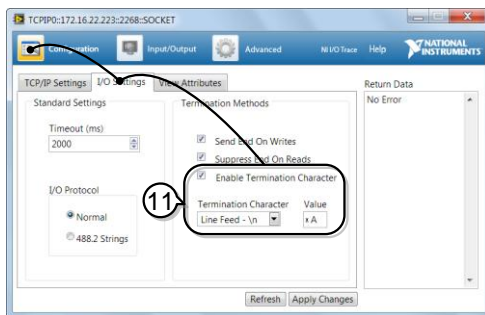

12. Click the *Input/Output* icon. Under the *Basic I/O* tab, make sure **IDN?\n* is entered in the *Select or Enter Command* drop box.
13. Click *Query*.

The ASR-2000 will return the machine identification string into the buffer area:

GW-INSTEK, ASR-2XXX, GXXXXXXXXX, XX.XX

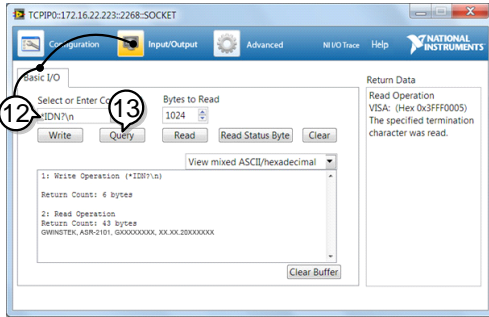

 Note

For further details, please see the programming manual, available on the GW Instek web site @ www.gwinstek.com.

FAQ

- The accuracy does not match the specification.
- How frequently should the power source be calibrated?
- Is it proper to combine 2 or 3 units to reach 1P3W or 3P4W output?

The accuracy does not match the specification.

Make sure the device is powered On for at least 30 minutes, within +18°C~+28°C. This is necessary to stabilize the unit to match the specification.

How frequently should the power source be calibrated?

The ASR-2000 should be calibrated by an authorized service center at least every 2 years.

For details regarding calibration, contact your local dealer or GWInstek.

Is it proper to combine 2 or 3 units to reach the 1P3W or 3P4W output?

Not available. ASR-2000 doesn't support 1P3W or 3P4W output function. Only support 1P2W output type.

For more information, contact your local dealer or GWInstek at www.gwinstek.com / marketing@goodwill.com.tw.

APPENDIX

Firmware Update

Background The ASR series firmware can be upgraded using the USB A port on the front panel. See your local distributor or the GW Instek website for the latest firmware information.



Note

- Ensure the DUT is not connected.
- Ensure the output is off.

Steps

1. Insert a USB Flash Drive into the USB port on front panel of the ASR.
 - The USB drive should include the **gw.sbt & gw.sb3 & gw_asr_kernel.blk** files in a directory name "gw"(USB\gw:).
2. Press the *Menu* key. The Menu setting will appear on the display.
 
3. Use the scroll wheel to go to item 9, *Special Function* and press *Enter*.

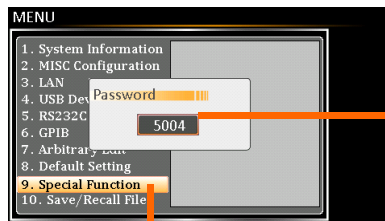

Enter
Password

Special Function

4. Key in the password when prompted and then press *Enter*.
 - The password is “5004”.
5. Go to Item 1, *Update Firmware* and press *Enter*.

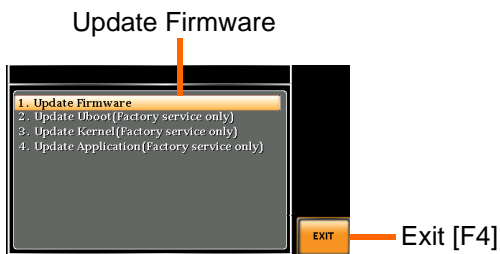

Exit

Press *Exit*[F4] to exit from the Update Firmware settings.

6. Wait for the unit to update. Upon completion the unit will automatically reboot.
7. Repeat the step 1 to 4 and go to “3. Update Kernel (Factory service only)” (ASR-2000 only).

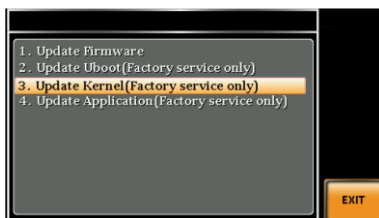

8. Wait for the unit to update. Upon completion the unit will automatically reboot.
 9. Load Default Setting.
-

Factory Default Settings

The following default settings are the factory configuration settings for the ASR-2000 series. For details on how to return to the factory default settings, see page 46.

AC+DC-INT Mode	ASR-2050	ASR-2050R	ASR-2100	ASR-2100R
Range			100V	
Wave Shape			SIN	
ACV			0.0 Vrms	
DCV			+0.0 Vdc	
FREQ			50.00 Hz	
IRMS	5.25 A			10.50 A
V Limit			+/- 250.0 Vpp	
F Limit Lo			1.0 Hz	
F Limit Hi			999.9 Hz	
IPK Limit	+/- 21.00 A			+/- 42.00 A
ON Phs			0.0°	
OFF Phs			0.0°	

AC-INT Mode	ASR-2050	ASR-2050R	ASR-2100	ASR-2100R
Range			100V	
Wave Shape			SIN	
ACV			0.0 Vrms	
FREQ			50.00 Hz	
IRMS	5.25 A			10.50 A
V Limit			175.0 Vrms	
F Limit Lo			40.0 Hz	
F Limit Hi			999.9 Hz	
IPK Limit	+/- 21.00 A			+/- 42.00 A
ON Phs			0.0°	
OFF Phs			0.0°	

DC-INT Mode	ASR-2050	ASR-2050R	ASR-2100	ASR-2100R
Range			100V	
DCV			0.0 Vdc	
I	5.25 A			10.50 A
V Limit			+/- 250.0 Vpp	
IPK Limit	+/- 21.00 A			+/- 42.00 A

AC+DC-EXT Mode	ASR-2050	ASR-2050R	ASR-2100	ASR-2100R
Range			100V	
GAIN			100.0	
IRMS		5.25 A		10.50 A
IPK Limit		+/- 21.00 A		+/- 42.00 A

AC-EXT Mode	ASR-2050	ASR-2050R	ASR-2100	ASR-2100R
Range			100V	
GAIN			100.0	
IRMS		5.25 A		10.50 A
IPK Limit		+/- 21.00 A		+/- 42.00 A

AC+DC-ADD Mode	ASR-2050	ASR-2050R	ASR-2100	ASR-2100R
Range			100V	
Wave Shape			SIN	
ACV			0.0 Vrms	
DCV			+0.0 Vdc	
GAIN			100.0	
FREQ			50.00 Hz	
IRMS		5.25 A		10.50 A
V Limit			+/- 250.0 Vpp	
F Limit Lo			1.0 Hz	
F Limit Hi			999.9 Hz	
IPK Limit		+/- 21.00 A		+/- 42.00 A
ON Phs			0.0°	
OFF Phs			0.0°	

AC-ADD Mode	ASR-2050	ASR-2050R	ASR-2100	ASR-2100R
Range			100V	
Wave Shape			SIN	
ACV			0.0 Vrms	
GAIN			100.0	
FREQ			50.00 Hz	
IRMS		5.25 A		10.50 A
V Limit			175.0 Vrms	
F Limit Lo			40.0 Hz	
F Limit Hi			999.9 Hz	
IPK Limit		+/- 21.00 A		+/- 42.00 A
ON Phs			0.0°	
OFF Phs			0.0°	

AC+DC-SYNC Mode	ASR-2050	ASR-2050R	ASR-2100	ASR-2100R
Range			100V	
Wave Shape			SIN	
ACV			0.0 Vrms	
DCV			+0.0 Vdc	
SIG			LINE	
IRMS		5.25 A		10.50 A
V Limit			+/- 250.0 Vpp	
F Limit			999.9 Hz	
IPK Limit		+/- 21.00 A		+/- 42.00 A
ON Phs			0.0°	
OFF Phs			0.0°	
Syn Phs			0.0°	

AC-SYNC Mode	ASR-2050	ASR-2050R	ASR-2100	ASR-2100R
Range			100V	
Wave Shape			SIN	
ACV			0.0 Vrms	
SIG			LINE	
IRMS		5.25 A		10.50 A
V Limit			175.0 Vrms	
F Limit			999.9 Hz	
IPK Limit		+/- 21.00 A		+/- 42.00 A
ON Phs			0.0°	
OFF Phs			0.0°	
Syn Phs			0.0°	

AC-VCA Mode	ASR-2050	ASR-2050R	ASR-2100	ASR-2100R
Range			100V	
Wave Shape			SIN	
GAIN			100.0	
IRMS		5.25 A		10.50 A
V Limit			175.0 Vrms	
F Limit			999.9 Hz	
IPK Limit		+/- 21.00 A		+/- 42.00 A
ON Phs			0.0°	
OFF Phs			0.0°	

Menu	ASR-2000
T ipeak, hold(msec)	1 ms
IPK CLR	EXEC

Power ON	OFF
Buzzer	ON
Remote Sense	OFF
Slew Rate Mode	Slope
Output Relay	Enable
THD Format	IEC
External Control	OFF
V Unit (TRI, ARB)	rms
ACin Detection	ON
TrgOut Width	0.1

LAN ASR-2000

DHCP	ON
------	----

USB Device ASR-2000

Speed	Full
-------	------

Sequence Mode ASR-2000

Step	0
Time	0.1000 s
ACV	0.0, CT
DCV	0.0, CT
Fset	50.0, CT
Wave	SIN
Jump To	OFF
Jump Cnt	1
Branch 1	OFF
Branch 2	OFF
Term	CONTI
Sync Code	LL
ON Phs	Free
OFF Phs	Free

Simulation Mode ASR-2000

Step	Initial
Repeat	OFF
Time	0.1000 s
ACV	0.0
Fset	50.00
ON Phs	Free
OFF Phs	Free

Wave	SIN
Code	LL

RS232C	ASR-2000
--------	----------

Baudrate	9600
----------	------

Databits	8bits
----------	-------

Parity	None
--------	------

Stopbits	1bit
----------	------

GPIB	ASR-GPIB-2K Option
------	--------------------

Address	10
---------	----

Error Messages & Messages

The following error messages or messages may appear on the ASR-2000 screen display during varied operations.

Error Messages	Description	Protection type
Over Ipeak+ Current	Positive output current peak value is excessive. Press "Shift + Cancel" to clear this alarm.	Output Off
Over Ipeak- Current	Negative output current peak value is excessive. Press "Shift + Cancel" to clear this alarm.	Output Off
Overheat(1)/(2)	Internal power stage over heat. Press "Shift + Cancel" to clear this alarm. Check if operating temperature is suitable and if filter is clogged.	Output Off
Over Irms Current	Output current RMS value is excessive. Press "Irms" to check allowance set range	Output Off
Power Input Anomaly / System Shutdown	The power input voltage is insufficient or turning off main power switch. Check input power before rebooting the unit.	System Lock
Fan Failure	Fan failure. Contact service center.	System Lock
Output Over-Power	Over internal power stage maximum power (110% of rating power), press "Shift + Cancel" to clear this alarm.	Output Off
Output Short(1)/(2)	Call attention to output terminal short status	Output Off
Output Overvoltage	Over internal maximum voltage (110% of rating voltage). Press "Shift + Cancel" to clear this alarm.	Output Off
Calibration Data Error	The calibration data is abnormal or out of allowance range. Contact service center.	Output Off

Sensing Voltage Error	Remote sense connection wire is abnormal or over maximum compensation voltage. Press "Shift + Cancel" to clear this alarm.	Output Off
Startup Anomaly	Abnormal startup procedure. Contact service center.	System Lock
External Sync Frequency Error	The external synchronization signal input frequency is out of the allowance range. (40Hz ~ 999.9Hz)	Output Off
SCPI Error	Communication with the SCPI command error	Display Message Only
Power ON Fail	Power ON Function Fail In Error Mode or Range	
IRMS Limit	The RMS current limiter is activated. Press "Irms" to check allowance set range	
IPK Limit	The peak current limiter is activated. Press " Shift + Irms" to check allowance set range	
Remote Sensing Voltage Out of Range	The Sensing voltage limiter is activated.	Display Message Only
System Error (#)	System Error (1~15). Contact service center.	Display Message Only
Power Limit	The Power limiter is activated	
Web Data Error	This message will only be shown when texio update file is used and firmware is selected gw.	



Note

The system would be locked or output off automatically before the error state is cleared.

Normal Messages	Description	Protection type
Setting Voltage Limited	Setting voltage be limited, press "Shift + V" to check allowance set range	Display Message Only
Setting Frequency Limited	Setting frequency be limited, press "Shift + F" to check allowance set range	Display Message Only

Keys Locked	All of keys are locked, except output key. Long push "Lock" to disable Keys Locked.	Display Message Only
Keys Unlocked	All of keys are unlocked	Display Message Only
Screen Saved to USB:/GWDIMC###.bmp	Screenshot be saved to USB memory successful	Display Message Only
Hardcopy Fail! (Too Many Files in USB)	Hardcopy Fail !, Over 1000 files in USB	Display Message Only
USB Memory Unconnected	Could not detect USB memory	Display Message Only
Preset Mode	Operation at preset mode	Display Message Only
Exit Preset Mode	Exit preset mode	Display Message Only
Invalid with Remote Control	All of keys are locked, except Output and Shift and Local Key. Press "Shift + Preset" to disable Remote Control.	Display Message Only
Invalid with Remote Lock Control	All of keys including Output and Local Keys are locked.	Display Message Only
Invalid in This Meter Frozen	Invalid Operation In This Meter Frozen. Press "F4" to disable Meter Frozen	Display Message Only
Invalid in This Page	Invalid Operation In This Page. Valid main and simple page for preset mode.	Display Message Only
Recalled From M#	Recalled Preset From M0 ~ M9	Display Message Only
Saved To M#	Saved Preset To M0 ~ M9	Display Message Only
Resetting...	Ready For Recall Factory Default	Display Message Only
Failed Factory Default	Recall Factory Default Failed	Display Message Only
Error Password	Input Error Password	Display Message Only
No File ([Filename]) in [directory]	Not find specific file in USB specific directory	Display Message Only

Saved to DEF1	Saved Setting to DEF1	Display Message Only
Saved to DEF2	Saved Setting to DEF1	Display Message Only
Meter Frozen	Operation at Meter Frozen mode, all measure value will stop update.	Display Message Only
Only AC Mode And 50/60Hz Active	Harmonic Page Limit Message	Display Message Only
[Filename] Saved Success	Save file to USB success message. [Filename] ex Preset0.Set or SEQ0.SEQ or SIM0.SIM or ARB1.ARB	Display Message Only
[Filename] Save Fail	Save file to USB fail message	Display Message Only
[Filename] Recalled Success	Recalled file success message	Display Message Only
[Filename] Recall Fail (No File in [directory])	Recall file fail message (not find specific file in USB specific directory)	Display Message Only
[Filename] Recall Fail (Model ([Model]) Error	Recall file fail message. (Preset, Seq and Sim files could Not be recalled among varied models, e.g., file of ASR-2050 can Not be recalled in ASR-2100.)	Display Message Only
[Filename] Recall Fail (File Format Error)	Recall file fail message (file format error)	Display Message Only
Preset M# Deleted	Preset M0–M9 Deleted	Display Message Only
ARB# Deleted	ARB1–ARB16 Deleted	Display Message Only
USB Memory Connected	Detect USB Memory connected	Display Message Only
USB Memory Access Error	The format of the USB flash drive is not FAT32 or abnormal in reading	Display Message Only
Valid Only AC-INT, DC-INT and AC-Sync Mode	Remote Sense Setting Limit Message	Display Message Only
Valid Only 100V and 200V Range	Remote Sense Setting Limit Message	Display Message Only
Valid Only SIN Wave Shape	Remote Sense Setting Limit Message	Display Message Only

Valid Only Time Slew Rate Mode	Remote Sense Setting Limit Message	Display Message Only
USB File Write Error!	Can Not Save File to USB	Display Message Only
Invalid in This Output Mode	This mode not support SEQ or SIM Valid Only AC+DC-INT, AC-INT and DC-INT Mode for SEQ Valid Only AC+DC-INT Mode for SIM	Display Message Only
Invalid For Auto Range	Auto range does Not allow SEQ/SIM, change the output range	Display Message Only
Invalid with Output OFF, Turn ON the Output First	The output off state does Not allow the execution. Turn on the output first	Display Message Only
Invalid with Output ON, Turn OFF the Output First	The output on state does Not allow the execution. Turn off the output first	Display Message Only
Invalid in This Sequence	Invalid Operation In This Sequence	Display Message Only
SEQ# Deleted	SEQ0~SEQ9 Deleted	Display Message Only
SIM# Deleted	SIM0~SIM9 Deleted	Display Message Only
Cleared SEQ#	Cleared SEQ0~SEQ9	Display Message Only
Cleared SIM#	Cleared SIM0~SIM9	Display Message Only
Recalled from SEQ#	%s is File Name , ex SEQ0~SEQ9 or SIM0~SIM9	Display Message Only
Recalled from SIM#	Recalled from SIM0 ~ SIM9	Display Message Only
Recall Fail!	SEQ0 ~ SEQ9 or SIM0 ~ SIM9 Recall Fail!	Display Message Only
Saved to SEQ#	Saved to SEQ0 ~ SEQ9	Display Message Only
Saved to SIM#	Saved to SIM0 ~ SIM9	Display Message Only
Save Fail!	SEQ0 ~ SEQ9 or SIM0 ~ SIM9 save Fail!	Display Message Only

Sequence preparation...	Sequence preparation, please wait some time	Display Message Only
Sequence is ready.	Sequence is ready.	Display Message Only
Simulation preparation...	Simulation preparation, please wait some time	Display Message Only
Simulation is ready.	Simulation is ready.	Display Message Only
Save All Data	Ready to save all data (Preset0~9 + SEQ0~9 + SIM0~9 + ARB1~16)	Display Message Only
All Data Saved Success	All data are saved successfully (Preset0~9 + SEQ0~9 + SIM0~9 + ARB1~16)	Display Message Only
Recall All Data	Ready to recall all data (Preset0~9 + SEQ0~9 + SIM0~9 + ARB1~16)	Display Message Only
All Data Recall Success	All data are recalled successfully (Preset0~9 + SEQ0~9 + SIM0~9 + ARB1~16)	Display Message Only
Delete All Data	Ready to delete all data (Preset0~9 + SEQ0~9 + SIM0~9 + ARB1~16)	Display Message Only
All Data Deleted	All data are deleted successfully (Preset0~9 + SEQ0~9 + SIM0~9 + ARB1~16)	Display Message Only

Communication Interface Messages	Description	Protection type
Rear USB Port Connected To PC	Rear USB port connected to PC	Display Message Only
Rear USB Port Disconnected From PC	Rear USB port disconnected from PC	Display Message Only

Specifications

The specifications apply when the ASR-2000 is powered on for at least 30 minutes.

Electrical specifications

Model	ASR-2050 ASR-2050R	ASR-2100 ASR-2100R
Input ratings (AC rms)		
Nominal input voltage	100 Vac to 240 Vac	
Input voltage range	90 Vac to 264 Vac	
Phase	Single phase, Two-wire	
Nominal input Frequency	50 Hz to 60 Hz	
Input frequency range	47 Hz to 63 Hz	
Max. power consumption	800 VA or less	1500 VA or less
Power factor ^{*1}	100Vac	0.95 (typ.)
	200Vac	0.90 (typ.)
Max. input current	100Vac	8 A
	200Vac	4 A
		15 A
		7.5 A

*1 For an output voltage of 100 V/200 V (100V / 200V range), maximum current, and a load power factor of 1.

Model	ASR-2050 ASR-2050R	ASR-2100 ASR-2100R	
AC mode output ratings (AC rms)			
Voltage	Setting Range ^{*1}	0.0 V to 175.0 V / 0.0 V to 350.0 V	
	Setting Resolution	0.1 V	
	Accuracy ^{*2}	±(0.5 % of set + 0.6 V / 1.2 V)	
Output phase	Single phase, Two-wire		
Maximum current ^{*3}	100 V	5 A	10 A
	200 V	2.5 A	5 A
Maximum peak current ^{*4}	100 V	20 A	40 A
	200 V	10 A	20 A
Load power factor	0 to 1 (leading phase or lagging phase)		
Power capacity	500 VA	1000 VA	
Frequency	Setting range	AC Mode: 40.00 Hz to 999.9 Hz, AC+DC Mode: 1.00 Hz to 999.9 Hz	
	Setting resolution	0.01 Hz (1.00 to 99.99 Hz), 0.1 Hz (100.0 to 999.9 Hz)	
	Accuracy	For 45 Hz to 65 Hz: 0.01% of set For 1 Hz to 999.9 Hz: 0.02% of set	
	Stability ^{*5}	± 0.005%	
Output on/off phase	0.0° to 359.9° variable (setting resolution 0.1°)		
DC offset ^{*6}	Within ± 20 mV (TYP)		

*1 100 V / 200 V range

*2 For an output voltage of 17.5 V to 175 V / 35 V to 350 V, sine wave, an output frequency of 45 Hz to 65 Hz, no load, DC voltage setting 0V (AC+DC mode) and 23°C ± 5°C

*3 For an output voltage of 1 V to 100 V / 2 V to 200 V. Limited by the power capacity when the output voltage is 100 V to 175 V / 200 V to 350 V. If there is the DC superimposition, the current of AC+DC mode satisfies the maximum current. In the case of lower than 40 Hz, and the ambient temperature is 40°C or higher, the maximum current will be decrease.

*4 With respect to the capacitor-input rectifying load. Limited by the maximum current.

*5 For 45 Hz to 65 Hz, the rated output voltage, no load and the resistance load for the maximum current, and the operating temperature.

*6 In the case of the AC mode and output voltage setting to 0 V.

Model		ASR-2050 ASR-2050R	ASR-2100 ASR-2100R
Output rating for DC mode			
Voltage	Setting Range*1	-250.0 V to +250.0 V / -500.0 V to +500.0 V	
	Setting	0.1 V	
	Resolution		
	Accuracy*2	±(0.5 % of set + 0.6 V / 1.2 V)	
Maximum current*3	100 V	5 A	10 A
	200 V	2.5 A	5 A
Maximum peak current*4	100 V	20 A	40 A
	200 V	10 A	20 A
Power capacity		500 W	1000 W

*1 100 V / 200 V range

*2 For an output voltage of -250 V to -25 V, +25 V to +250 V / -500 V to -50 V, +50 V to +500 V, no load, AC voltage setting 0V (AC+DC mode) and 23°C ± 5°C

*3 For an output voltage of 1.4 V to 100 V / 2.8 V to 200 V. Limited by the power capacity when the output voltage is 100 V to 250 V / 200 V to 500 V.

*4 Within 5 ms, Limited by the maximum current.

Model		ASR-2050 ASR-2050R	ASR-2100 ASR-2100R
Output voltage stability			
Line regulation*1		±0.2% or less	
Load regulation*2		±0.15% @45 - 65Hz	
		±0.5% @DC, all other frequencies (0 to 100%, via output terminal)	
Ripple noise*3		0.7 Vrms / 1.4 Vrms (TYP)	

*1 Power source input voltage is 100 V, 120 V, or 230 V, no load, rated output.

*2 For an output voltage of 75 V to 175 V / 150 V to 350 V, a load power factor of 1, stepwise change from an output current of 0 A to maximum current (or its reverse), using the output terminal on the rear panel.

*3 For 5 Hz to 1 MHz components in DC mode using the output terminal on the rear panel.

Model	ASR-2050 ASR-2050R	ASR-2100 ASR-2100R
Output voltage waveform distortion ratio, Output voltage response time, Efficiency		
Total harmonic distortion (THD) ^{*1}	<0.2 % @50/60 Hz <0.3 % @<500 Hz <0.5 % @500.1 Hz to 999.9 Hz	
Output voltage response time ^{*2}	100 μs (TYP)	
Efficiency ^{*3}	70 % or more	
^{*1} At an output voltage of 50 V to 175 V / 100 V to 350 V, a load power factor of 1, and in AC and AC+DC mode.		
^{*2} For an output voltage of 100 V / 200 V, a load power factor of 1, with respect to stepwise change from an output current of 0 A to the maximum current (or its reverse). 10% ~ 90% of output voltage		
^{*3} For AC mode, at an output voltage of 100 V / 200 V, maximum current, and load power factor of 1 and sine wave only.		

Model	ASR-2050 ASR-2050R	ASR-2100 ASR-2100R
Measured value display		
Note: All accuracy of the measurement function is indicated for 23 °C±5 °C.		
Voltage	RMS, AVG value ^{*1}	Resolution 0.1 V Accuracy ^{*2} For 45 Hz to 65 Hz and DC: ±(0.5 % of reading + 0.3 V / 0.6 V) For 40 Hz to 999.9 Hz: ±(0.7 % of reading + 0.9 V / 1.8 V)
	PEAK value	Resolution 0.1 V Accuracy For 45 Hz to 65 Hz and DC: ±(2 % of reading + 1 V / 2 V)
Current	RMS, AVG value	Resolution 0.01 A Accuracy ^{*3} For 45 Hz to 65 Hz and DC: ±(0.5 % of reading + 0.02 A / 0.02 A) For 40 Hz to 999.9 Hz: ±(0.7 % of reading + 0.04 A / 0.04 A)
	PEAK value	Resolution 0.01 A Accuracy ^{*4} For 45 Hz to 65 Hz and DC: ±(2 % of reading + 0.2 A / 0.1 A)

Power	Active (W)	Resolution	0.1 / 1 W	
		Accuracy* ⁵	±(2 % of reading + 0.5 W)	±(2 % of reading + 1 W)
	Apparent (VA)	Resolution	0.1 / 1 VA	
		Accuracy* ^{5*6}	±(2 % of reading + 0.5 VA)	±(2 % of reading + 1 VA)
	Reactive (VAR)	Resolution	0.1 / 1 VAR	
		Accuracy* ^{5*7}	±(2 % of reading + 0.5 VAR)	±(2 % of reading + 1 VAR)
Load power factor	Range	0.000 to 1.000		
	Resolution	0.001		
Load crest factor	Range	0.00 to 50.00		
	Resolution	0.01		
Harmonic voltage Effective value (rms)	Range	Up to 100th order of the fundamental wave		
	Full Scale	175 V / 350 V, 100%		
Percent (%) (AC-INT and 50/60 Hz only)	Resolution	0.1 V, 0.1%		
	Accuracy* ⁸	Up to 20th ±(0.2 % of reading + 0.5 V / 1 V) 20th to 100th ±(0.3 % of reading + 0.5 V / 1 V)		
Harmonic current Effective value (rms)	Range	Up to 100th order of the fundamental wave		
	Full Scale	5 A / 2.5 A, 100%	10 A / 5 A, 100%	
Percent (%) (AC-INT and 50/60 Hz only)	Resolution	0.01 A, 0.1%		
	Accuracy* ³	Up to 20th ±(1 % of reading + 0.1 A / 0.05 A) 20th to 100th ±(1.5 % of reading + 0.1 A / 0.05 A)	Up to 20th ±(1 % of reading + 0.2 A / 0.1 A) 20th to 100th ±(1.5 % of reading + 0.2 A / 0.1 A)	

*1 The voltage display is set to RMS in AC/AC+DC mode and AVG in DC mode.

*2 AC mode: For an output voltage of 17.5 V to 175 V / 35 V to 350 V and 23 °C ± 5 °C. DC mode: For an output voltage of 25 V to 250 V / 50 V to 500 V and 23 °C ± 5.

*3 An output current in the range of 5 % to 100 % of the maximum current, and 23 °C ± 5 °C.

*4 An output current in the range of 5 % to 100 % of the maximum peak current in AC mode, an output current in the range of 5 % to 100 % of the maximum instantaneous current in DC mode, and 23 °C ± 5 °C. The accuracy of the peak value is for a waveform of DC or sine wave

*5 For an output voltage of 50 V or greater, an output current in the range of 10 % to 100 % of the maximum current, DC or an output frequency of 45 Hz to 65 Hz, and 23 °C ± 5 °C.

*6 The apparent and reactive powers are not displayed in the DC mode.

*7 The reactive power is for the load with the power factor 0.5 or lower.

*8 An output voltage in the range of 17.5 V to 175 V / 35 V to 350 V and $23\text{ }^{\circ}\text{C} \pm 5\text{ }^{\circ}\text{C}$.



Note

- Product specifications are subject to change without notice.
- The spec aforementioned applies to when slew rate mode is the Time mode.

General Specifications

Interface	Standard	USB	Type A: Host, Type B: Device, Speed: 1.1/2.0, USB-CDC
		LAN	MAC Address, DNS IP Address, User Password, Gateway IP Address, Instrument IP Address, Subnet Mask
		EXT Control	External Signal Input External Control I/O
		RS232C	Complies with the EIA-RS232 specifications
	ASR-GPIB-2K	GPIB	SCPI-1993, IEEE 488.2 compliant interface
Insulation resistance	Between input and chassis, output and chassis, input and output		500 Vdc, 30 MΩ or more
Withstand voltage	Between input and chassis, output and chassis, input and output		1500 Vac, 1 minute
EMC			EN 61326-1 (Class A) EN 61326-2-1/-2-2 (Class A) EN 61000-3-2 (Class A, Group 1) EN 61000-3-3 (Class A, Group 1) EN 61000-4-2/-4-3/-4-4/-4-5/-4-6/-4-8/-4-11 (Class A, Group 1) EN 55011 (Class A, Group1)
Safety			EN 61010-1
Environment	Operating environment		Indoor use, Overvoltage Category II
	Operating temperature range		0 °C to 40 °C
	Storage temperature range		-10 °C to 70 °C
	Operating humidity range		20 % RH to 80 % RH (no condensation)
	Storage humidity range		90 % RH or less (no condensation)
	Altitude		Up to 2000 m
Dimensions (mm)		ASR-2000	ASR-2000R
		285(W)×124(H)×480(D) (not including protrusions)	213(W)×124(H)×480(D) (not including protrusions)
Weight		ASR-2000	ASR-2000R
		Approx. 11.5 kg	Approx. 10.5 kg

Others

Protections	OCP, OTP, OPP, FAN Fail
Display	TFT-LCD, 4.3 inch
Memory Function	Store and recall settings, Basic settings: 10
Arbitrary	16 (nonvolatile)
Wave	4096 words

A value with the accuracy is the guaranteed value of the specification. However, an accuracy noted as reference value shows the supplemental data for reference when the product is used, and is not under the guarantee. A value without the accuracy is the nominal value or representative value (shown as type).

External Signal Input (AC+DC-EXT, AC-EXT Mode)

	Specification	Factory Default
Gain setting range	100 V range: 0.0 to 250.0 times	100
	200 V range: 0.0 to 500.0 times	200
Input terminal	BNC connector	
Input impedance	1 M Ω	
Input voltage range	± 2.5 V (A/D resolution 12 bit)	
Nondestructive maximum input voltage	± 10 V	
Gain resolution	0.1 times	
Accuracy	± 5 % (DC, or 45Hz ~ 65 Hz, gain is at initial value, with rate voltage output, no load)	

EXT: Output voltage (V) = External signal input (V) x Gain (V/V)

Voltage Setting Signal Input (AC-VCA Mode)

	Specification	Factory Default
Gain setting range	100 V range: 0.0 to 250.0 times	100
	200 V range: 0.0 to 500.0 times	200
Input terminal	BNC connector	
Input impedance	1 M Ω	
Input voltage range	DC 0 ~ 2.5 V	
Nondestructive maximum input voltage	± 10 V	
Accuracy	± 5 %	

External Signal Input (AC+DC-ADD, AC-ADD Mode)

	Specification	Factory Default
Gain setting range	100 V range: 0.0 to 250.0 times	100
	200 V range: 0.0 to 500.0 times	200
Input terminal	BNC connector	
Input impedance	1 M Ω	
Input voltage range	± 2.5 V (A/D resolution 12 bit)	
Nondestructive maximum input voltage	± 10 V	
Input frequency range	DC to 999.9 Hz (sine wave)	
	DC to 100 Hz (other than sine wave)	
Gain resolution	0.1 times	
Accuracy	± 5 % (DC, or 45Hz ~ 65 Hz, gain is at initial value, with rate voltage output, no load)	

ADD: Output voltage (V) = External signal input (V) \times Gain (V/V) + Internal signal source setting (V)

External Synchronous Signal or Line (AC+DC-SYNC, AC-SYNC)

	Specification	Factory Default
Synchronization signal source	External synchronization signal (EXT) or Power input (LINE)	LINE
Synchronization frequency range	40.00 Hz to 999.9 Hz	
Input terminal	BNC connector	
Input impedance	1 M Ω	
Threshold of input voltage	TTL level	
Minimum pulse width	500 μ s	
Nondestructive maximum input voltage	± 10 V	
Resolution	0.01 / 0.1 Hz	
Accuracy	± 0.2 Hz	

Information of Name Order

The name order of ASR-2000 series has its rules in definition for each character by order. Refer to the following contents for details.

Background	The definitions below describe the meanings behind each group of alphanumeric characters, in varied colors, of naming code for ASR series models.	
Naming Definition	ASR	Switching Mode AC Power Source
	2	Series Name
	XX	Output Capacity 05 : 500VA 10 : 1000VA
	0	Fixed number
	X	Front Outlet (factory option) Blank : Desktop R : Rack Mount
Lineup of ASR Series Models	ASR-2050 ASR-2100 ASR-2050 R ASR-2100 R	

ASR-2000 Dimensions

ASR-2100/2050

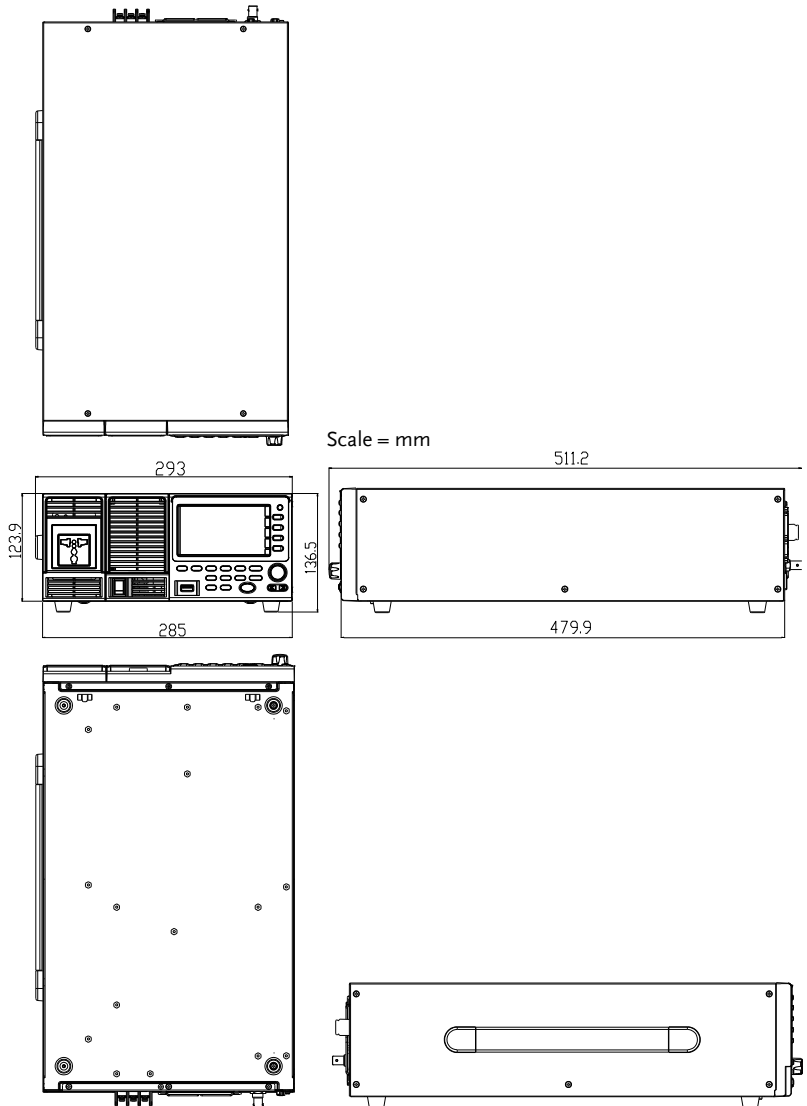

ASR-2100R/2050R

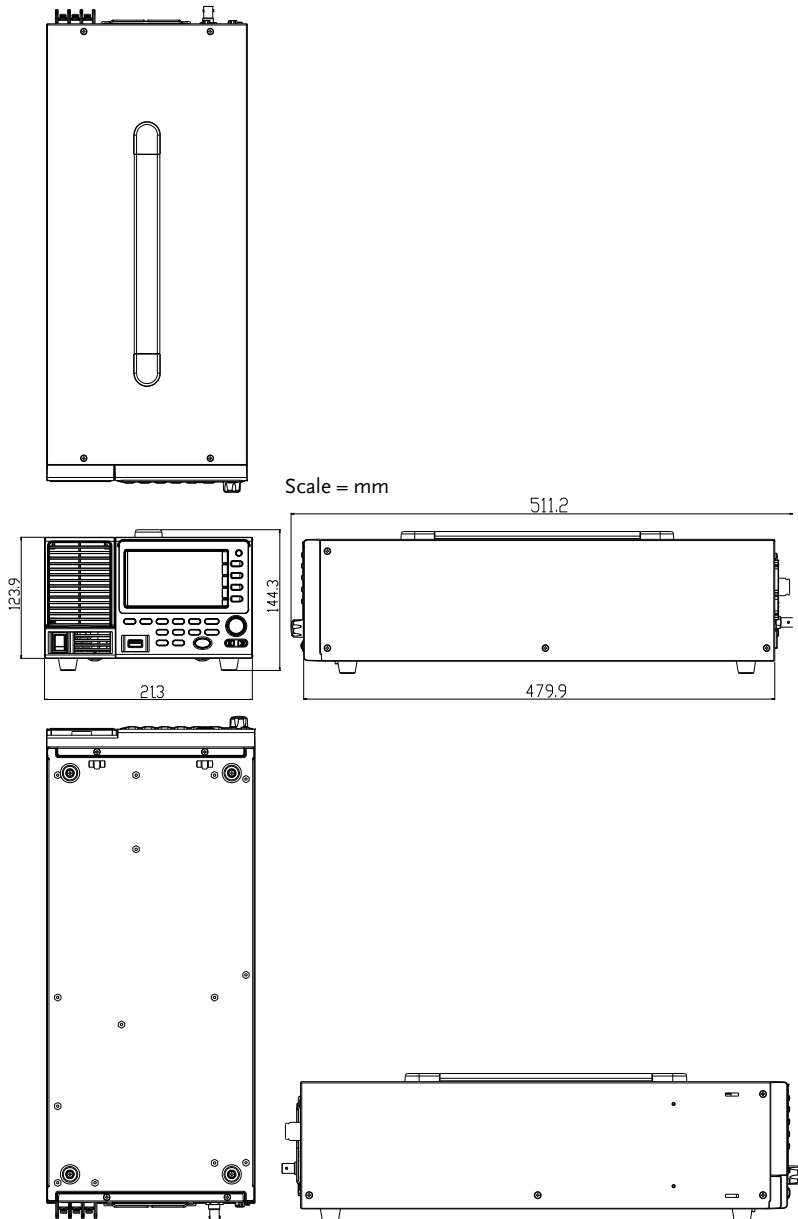

ASR-2100R/2050R with GET Series Box

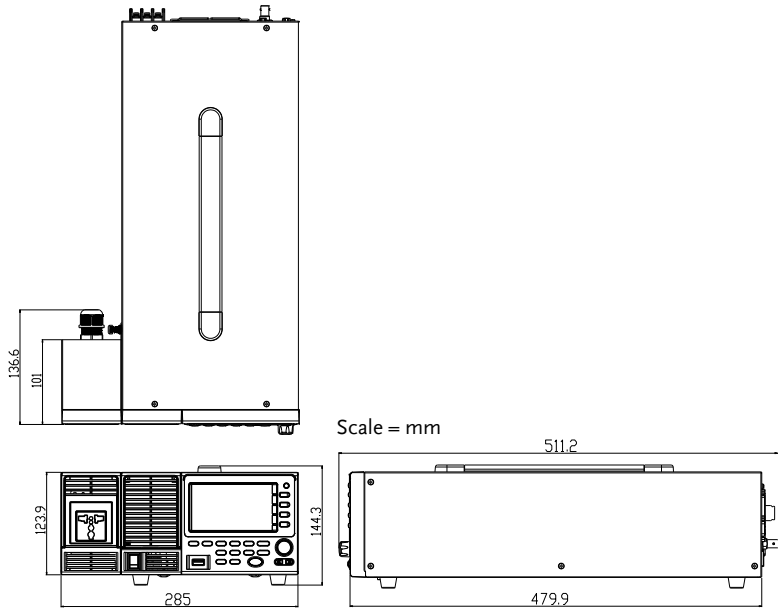

GET-003 Series Box

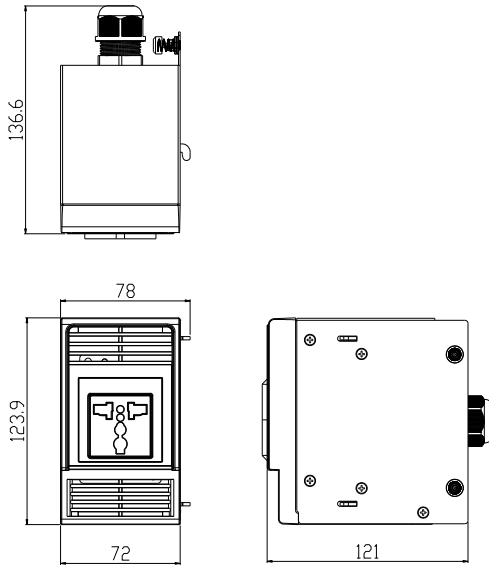
**GET-004 Series Box**

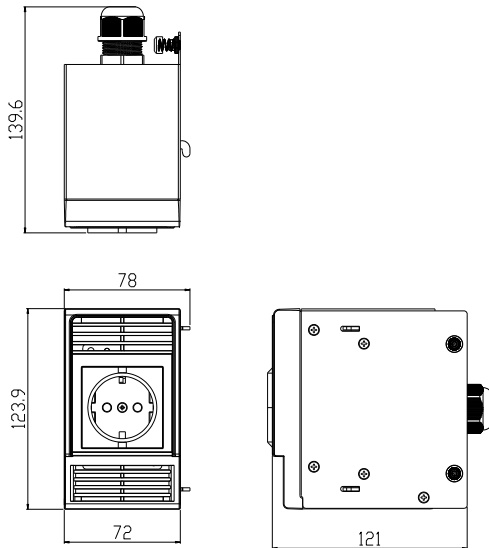

Declaration of Conformity

We

GOOD WILL INSTRUMENT CO., LTD.

declare that the below mentioned product

Type of Product: Programmable AC/DC Power Source

Model Number: ASR-2050, ASR-2100, ASR-2050R, ASR-2100R

satisfies all the technical relations application to the product within the scope of council:

Directive: 2014/30/EU; 2014/35/EU; 2011/65/EU; 2012/19/EU

The above product is in conformity with the following standards or other normative documents:

© **EMC**

EN 61326-1 : EN 61326-2-1: EN 61326-2-2:	Electrical equipment for measurement, control and laboratory use — EMC requirements (2013)
Conducted & Radiated Emission EN 55011: 2016+A1:2017 Class A	Electrical Fast Transients EN 61000-4-4: 2012
Current Harmonics EN 61000-3-2: 2014	Surge Immunity EN 61000-4-5: 2014+A1:2017
Voltage Fluctuations EN 61000-3-3: 2013	Conducted Susceptibility EN 61000-4-6: 2014
Electrostatic Discharge EN 61000-4-2: 2009	Power Frequency Magnetic Field EN 61000-4-8: 2010
Radiated Immunity EN 61000-4-3: 2006+A2:2010	Voltage Dip/ Interruption EN 61000-4-11: 2004+A1:2017

© **Safety**

Low Voltage Equipment Directive 2014/35/EU	
Safety Requirements	EN 61010-1:2010

GOODWILL INSTRUMENT CO., LTD.

No. 7-1, Jhongsing Road, Tucheng District, New Taipei City 236, Taiwan

Tel: [+886-2-2268-0389](tel:+886-2-2268-0389)

Fax: [+886-2-2268-0639](tel:+886-2-2268-0639)

Web: <http://www.gwinstek.com>

Email: marketing@goodwill.com.tw

GOODWILL INSTRUMENT (SUZHOU) CO., LTD.

No. 521, Zhujiang Road, Snd, Suzhou Jiangsu 215011, China

Tel: [+86-512-6661-7177](tel:+86-512-6661-7177)

Fax: [+86-512-6661-7277](tel:+86-512-6661-7277)

Web: <http://www.instek.com.cn>

Email: marketing@instek.com.cn

GOODWILL INSTRUMENT EURO B.V.

De Run 5427A, 5504DG Veldhoven, The Netherlands

Tel: [+31-\(0\)40-2557790](tel:+31-(0)40-2557790)

Fax: [+31-\(0\)40-2541194](tel:+31-(0)40-2541194)

Email: sales@gw-instek.eu

Maintenance & Regular Inspection

Background The potential malfunctions and faults may occur on ASR-2000 due to scores of reasons like humidity, temperature, dust, vibration as well as aging and wear of components. Consequently, to conduct regular maintenance and inspection on ASR-2000 is highly suggested on daily basis.



Note

The maintenance and inspection can only be performed by qualified and authorized technician or personnel.

Regular Inspection

Background To achieve a systematically regular inspection, the daily operating data, parameter-relevant records, among other critical information should be well taken down for the establishment of thorough application files for ASR-2000.

Object	Item	Method
Operating Environment Inspection	Temperature & Humidity	Use both thermometer and hygrometer to check if ambient temperature is lower than 40°C and if the requirement of humidity is well met at all times.
	Moisture, Dust & Leak	Observe and make sure no dust bunnies, nor water leak traces and condensation occur.
	Gas Leak	To sniff if there is any abnormal odor or color existed.
Equipment	Vibration	Check if the equipment is operating stably and free from any vibration.

Heating & Cooling	From the wind hole check if the fan runs adequately and make sure both wind speed and wind volume are in normal status.
Noise	Ensure that no abnormal noise does happen.

Maintenance

Calibration	Before shipping, we confirm that the proper calibration procedure was implemented in each unit. Nevertheless, in order to maintain the highest performance, we strongly suggest that the periodic calibration is necessary. Contact your dealer or local distributor for calibration.
-------------	---

Cleaning	Gently wipe the unit by a soft cloth dipped with neutral diluted detergent when the unit is in need of cleaning. Avoid using volatile chemicals, e.g., benzene, in that some irreversible results may occur as follows.
----------	---

Discolored surface

Printed characters erased

Clouded display



Note

Before maintenance jobs, it is imperative to turn Off the power switch and remove the power cord from the unit as possible electric shock, which leads to injury or death, may occur if not doing so.

INDEX

- Accessories 13
- Advanced settings
 - Buzzer134
 - Power output132
 - Program timer unit.....135
 - SCPI emulation137, 139, 140, 142, 143, 144, 149, 150
 - T Ipeak 46, 129, 131, 146
- Alarm
 - description.....24, 25, 27
- Alarm clear 101
- Analog control
 - overview112, 128, 151
- ARB
 - Overview46
- Buzzer 134
- Caution symbol..... 5
- Cleaning the instrument 7
- clear alarm 101
- Conventions 34
- Current RMS 83
- Declaration of conformity 230
- Default settings 205, 210
 - reset50
- Delete sequence memory 125, 163
- Delete simulation memory 177
- Display mode
 - operation.....92, 98
- Disposal instructions 8
- EN61010
 - measurement category.....6
 - pollution degree.....8
- Environment
 - safety instruction7
- Ethernet
 - interface183
- Filter installation..... 54
- Firmware update 203
- Frequency limit 76
- Frequency output.....79
- Front panel diagram 15
- Ground
 - symbol5
- I rms 83
- Ipk-Limit 81, 83, 84
- J1 connector
 - pin assignment 113
- List of features 12
- Load preset to local memory ..107
- Load preset to USB108
- Load sequence to USB125, 163
- Load simulation to USB 177
- Marketing
 - contact202
- Menu Tree58
- Model differences10
- Module installation..... 41
- On/off phase 85, 87
- Operation considerations.....29
 - inrush current.....29
- Output terminals..... 37
- Panel lock 95, 100
- Peak current limit..... 81, 83, 84
- Power on output 132
- Power on/off
 - safety instruction.....7
- Power up 34
- Program timer unit 135
- Rack mount
 - description 44
- Remote control 182
 - Ethernet 183
 - GPIB 192
 - LAN 183
 - RS232 186
 - USB 184

Remote control function check	view	51
GPIB	T Ipeak.....	46, 129, 131, 146
Realterm	Test	
RS-232	Sequence	
USB	Overview.....	152
Save preset to local memory ..	Recall.....	162
Save preset to USB.....	Run.....	167
Save sequence to USB	Save	162
Save simulation to USB.....	Settings	157
SCPI emulation.....	Simulation	
Serial number	Overview.....	169
view	Recall.....	176
Service operation	Run.....	180
about disassembly.....	Save	176
contact.....	Settings	172
Signal output	Updating the firmware	203
pin assignment	USB driver installation.....	52
Socket server function check..	Voltage limit	70
Start/stop phase	Voltage output level ..	73, 231, 232
SYNC output	Voltage range	64, 66, 67, 225
pin assignment	Warning symbol	5
System version	Web server function check	196
	Wire gauge chart.....	56