

3305F Mainframe Operation Manual



Material Contents Declaration

(材料含量宣称)

| (Part Name) 零件名称 | Hazardous Substance (有毒有害物质或元素) | | | | | |
|--|---------------------------------|-------|-------|---------------|---------------|-----------------|
| | 铅(Pb) | 汞(Hg) | 镉(Cd) | 六价铬 (Cr6+) | 多溴联 苯(PBB) | 多溴二苯醚 (PBDE) |
| PCBA (印刷电路装配件) | X | ○ | X | ○ | ○ | ○ |
| Electrical part not on PCBA's 未在PCBA上的电子零件 | X | ○ | X | ○ | ○ | ○ |
| Metal parts 金属零件 | ○ | ○ | ○ | X | ○ | ○ |
| Plastic parts 塑料零件 | ○ | ○ | ○ | ○ | X | X |
| Wiring 电线 | X | ○ | ○ | ○ | ○ | ○ |
| Package 封装 | X | ○ | ○ | ○ | ○ | ○ |

对销售之日的所售产品,本表显示, PRODIGIT 供应链的电子信息产品可能包含这些物质。注意:在所售产品中可能会也可能不会含有所有所列的部件。This table shows where these substances may be found in the supply chain of Prodigit electronic information products, as of the date of sale of the enclosed product. Note that some of the component types listed above may or may not be a part of the enclosed product. ○: 表示该有毒有害物质在该部件所有均质材料中的含量均在SJ/T 11363-2006 标准规定的限量要求以下。○: Indicates that the concentration of the hazardous substance in all homogeneous materials in the parts is below the relevant threshold of the SJ/T 113632006 standard. ×: 表示该有毒有害物质至少在该部件的某一均质材料中的含量超出SJ/T 11363-2006 标准规定的限量要求。×: Indicates that the concentration of the hazardous substance of at least one of all homogeneous materials in the parts is above the relevant threshold of the SJ/T 11363-2006 standard.

Note(注释):

1. Prodigit has not fully transitioned to lead-free solder assembly at this moment ; However, most of the components used are RoHS compliant.

(此刻, Prodigit 并非完全过渡到无铅焊料组装;但是大部份的元器件一至于RoHS的规定。)

2. The product is labeled with an environment-friendly usage period in years.

The marked period is assumed under the operating environment specified in the product specifications.

(产品标注了环境友好的使用期限(年)。所标注的环境使用期限假定是在此产品定义的使用环境之下。)



Example of a marking for a 10 year period:

(例如此标制环境使用期限为10年)

SAFETY SUMMARY

The following general safety precautions must be observed during all phases of operation, service, and repair of this instrument. Failure to comply with these precautions or with specific warnings elsewhere in this manual violates safety standards of design, manufacture, and intended use of the instrument. PRODIGIT assumes no liability for the *customer's failure to comply with these requirements*.

GENERAL

This product is a Safety Class 1 instrument (provided with a protective earth terminal). The protective features of this product may be impaired if it is used in a manner not specified in the operation instructions.

ENVIRONMENTAL CONDITIONS

This instrument is intended for indoor use in an installation category I, pollution degree 2 environments. It is designed to operate at a maximum relative humidity of 80% and at altitudes of up to 2000 meters. Refer to the specifications tables for the ac mains voltage requirements and ambient operating temperature range.

BEFORE APPLYING POWER

Verify that the product is set to match the available line voltage and the correct fuse is installed.

GROUND THE INSTRUMENT

This product is a Safety Class 1 instrument (provided with a protective earth terminal). To minimize shock hazard, the instrument chassis and cabinet must be connected to an electrical ground. The instrument must be connected to the ac power supply mains through a three conductor power cable, with the third wire firmly connected to an electrical ground (safety ground) at the power outlet. Any interruption of the protective (grounding) conductor or disconnection of the protective earth terminal will cause a potential shock hazard that could result in personal injury.

FUSES

Only fuses with the required rated current, voltage, and specified type (normal blow, time delay, etc.) should be used. Do not use repaired

Fuses or short circuited fuse holder. To do so could cause a shock or fire hazard.

DO NOT OPERATE IN AN EXPLOSIVE ATMOSPHERE.

Do not operate the instrument in the presence of flammable gases or fumes.

KEEP AWAY FROM LIVE CIRCUITS.

Operating personnel must not remove instrument covers. Component replacement and internal adjustments must be made by qualified service personnel. Do not replace components with power cable connected. Under certain conditions, dangerous voltages may exist even with the power cable removed. To avoid injuries, always disconnect power, discharge circuits and remove external voltage sources before touching components.

DO NOT SERVICE OR ADJUST ALONE.

Do not attempt internal service or adjustment unless another person, capable of rendering first aid and resuscitation, is present.

DO NOT EXCEED INPUT RATINGS.

This instrument may be equipped with a line filter to reduce electromagnetic interference and must be connected to a properly grounded receptacle to minimize electric shock hazard. Operation at line voltages or frequencies in excess of those stated on the data plate may cause leakage currents in excess of 5.0 mA peak.

DO NOT SUBSTITUTE PARTS OR MODIFY INSTRUMENT.

Because of the danger of introducing additional hazards, do not install substitute parts or perform any unauthorized modification to the instrument. Return the instrument to a PRODIGIT ELECTRONICS Sales and Service Office for service and repair to ensure that safety features are maintained.

Instruments which appear damaged or defective should be made inoperative and secured against unintended operation until they can be repaired by qualified service personnel.



EC DECLARATION OF CONFORMITY

We **Prodigit Electronics Co., Ltd.** declares under our own responsibility that the product

DC Electronic Load

(Model No.:

3310F, 3311F, 3312F, 3314F, 3315F, 3330F, 3332F, 3336F, 3340F, 3341F, 3342F,
33401F, 3300F, 3302F, 3305F)

satisfies all the technical relations application to the product within the scope of council:

Directive: 2014/30/EU; 2014/35/EU; 2015/863/EU; 2012/19/EU

The above product is in conformity with the following standards or other normative documents

Harmonized Standard :

EN 61010-1: 2010+A1:2019

EN IEC 61010-2-030:2021+A11:2021

EN 61326-1:2013

EN 61326-2-1:2013

Reference Basic Standards :

Emission:

EN 55011: 2016+A1: 2020 Class A

EN 55032: 2015+A1:2020

EN 61000-3-2: 2014

EN 61000-3-3: 2013

Immunity:

EN 61000-4-2: 2009

EN 61000-4-3: 2006+A2:2010

EN 61000-4-4: 2012

EN 61000-4-5: 2014+A1:2017

EN 61000-4-6: 2014

EN 61000-4-8: 2010

EN 61000-4-11: 2020

Company Name : Prodigit Electronics Co., Ltd.

**Company Address : 8F, No.88, Baojhong Rd., Sindian District, New Taipei City,
Taiwan.**

Person is responsible for marking this declaration:



Manufacturer/Importer

Signature:

Date: **2022/10/20** Name:

Dean Wang

Dean Wang
R&D Assistant Manager

UK CA UK Declaration of Conformity

We Prodigit Electronics Co., Ltd. declares under our own responsibility that the product

DC Electronic Load

(Model No.:

3310F, 3311F, 3312F, 3314F, 3315F, 3330F, 3332F, 3336F, 3340F, 3341F, 3342F,
33401F, 3300F, 3302F, 3305F)

satisfies all the technical relations application to the product within the scope of council:

Directive: Electromagnetic Compatibility Regulations 2016; Electrical Equipment (Safety) Regulations 2016; the Restriction of the Use of Certain Hazardous Substances in Electrical and Electronic Equipment Regulations 2012

The above product is in conformity with the following standards or other normative documents

Harmonized Standard :

BS EN 61010-1:2010+A1:2019 ; BS EN IEC 61010-2-030:2021+A11:2021
BS EN 61326-1: 2013 ; BS EN 61326-2-1: 2013

Reference Basic Standards :

Emission:

BS EN 55011: 2016+A1: 2020 Class A
BS EN 55032: 2015+A1:2020
BS EN 61000-3-2: 2014
BS EN 61000-3-3: 2013

Immunity:

BS EN 61000-4-2: 2009
BS EN 61000-4-3: 2006+A2:2010
BS EN 61000-4-4: 2012
BS EN 61000-4-5: 2014+A1:2017
BS EN 61000-4-6: 2014
BS EN 61000-4-8: 2010
BS EN 61000-4-11: 2020

Company Name : Prodigit Electronics Co., Ltd

**Company Address : 8F, No.88, Baojhong Rd., Sindian District, New Taipei City,
Taiwan**

Person is responsible for marking this declaration:



Manufacturer/Importer
Signature:

Dean Wang

Date: 2022/10/20

Name: Dean Wang
R&D Assistant Manager

SAFETY SYMBOLS

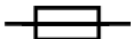
**Direct current (DC)****Alternating current (AC)****Both direct and alternating****Three-phase alternating current****Protective earth (ground)****On (Supply)****Off (Supply)****Fuse****Caution ! Refer to this manual before using the meter.****Caution, risk of electric shock**

CAT IV – Is for measurements performed at the source of the low-voltage installation.

CAT III – Is for measurements performed in the building installation.

CAT II – Is for measurements performed on circuits directly connected to the low-voltage installation.

CAT I – Is for measurements performed on circuits not directly connected to Mains.

This equipment is not for measurements performed for CAT II, III, and IV.

3305F Mainframe Operation Manual

Table of Contents

| | |
|---|-----------|
| CHAPTER 1 INTRODUCTION | 10 |
| 1.1 FEATURES | 11 |
| 1.2 STANDARD ACCESSORIES | 11 |
| 1.3 OPTION | 11 |
| 1.4 SPECIFICATIONS | 11 |
| CHAPTER 2 INSTALLATION | 12 |
| 2.1 INSPECTION | 12 |
| 2.2 CHECK LINE VOLTAGE..... | 12 |
| 2.3 INPUT FUSE..... | 13 |
| 2.4 GROUNDING REQUIREMENTS | 13 |
| 2.5 ENVIRONMENTAL REQUIREMENTS..... | 14 |
| 2.6 OBSERVE THE INTERNATIONAL ELECTRICAL SYMBOL LISTED BELOW | 14 |
| 2.7 CLEANING | 14 |
| 2.8 OBSERVE PRECAUTIONS FOR HANDLING ELECTROSTATIC SENSITIVE DEVICES..... | 15 |
| 2.9 POWER UP | 15 |
| 2.10 GPIB & RS232 CONNECTION OPTION | 15 |
| 2.11 RS232 INTERFACE OPTION | 16 |
| 2.12 GPIB CONNECTION OPTION..... | 17 |
| 2.13 USB CONNECTION OPTION..... | 17 |
| 2.14 LAN CONNECTION OPTION | 17 |
| 2.15 REMOTE CONTROLLER OPTION..... | 18 |
| 2.16 REMOTE CONTROLLER CONNECTION..... | 18 |
| 2.17 ANALOG PROGRAMMING INPUT..... | 19 |
| CHAPTER 3 MAINFRAME OPERATION | 20 |
| 3.1 POWER SWITCH | 22 |
| 3.2 LCD | 22 |
| 3.3 BUTTONS DESCRIPTION | 24 |
| 3.4 OPERATING INSTRUCTIONS | 25 |
| CHAPTER 4 REMOTE CONTROL PROGRAMMING OPERATION | 33 |
| 4.1 INTRODUCTION | 33 |
| 4.2 RS232 SET-UP..... | 33 |
| 4.3 PROGRAMMING SYNTAX, PARENTHESIS & TERMINATORS..... | 35 |
| 4.4 COMPUTER COMMANDS: SIMPLE TYPE FORMAT | 36 |
| 4.5 COMPUTER COMMANDS: COMPLEX TYPE FORMAT COMPLEX TYPE | 46 |
| FORMAT | 46 |
| 4.6 REMOTE CONTROL COMMAND DESCRIPTIONS..... | 54 |
| APPENDIX A GPIB PROGRAMMING EXAMPLE | 72 |
| APPENDIX B 3305F USB INSTRUCTION | 75 |
| APPENDIX C: 3305F LAN INSTALLATION | 77 |
| APPENDIX D: AUTO-SEQUENCE QUICK START WITH EXAMPLE | 79 |
| APPENDIX E: SHORT, OPP AND OCP TEST EXAMPLES | 82 |

Figures

FIG 2-1 SET OF SWITCH 12

FIG 2-2 FUSE RECEPTACLE 13

FIG 2-3 3305F REAR PANEL 16

FIG 2-4 3305F RS232 CONNECTION 16

FIG 2-5 3305F REAR PANEL 17

FIG 2-6 3305F USB CONNECTION 17

FIG 2-7 3305F LAN CONNECTION 18

FIG 2-8 3305F REMOTE CONTROLLER CONNECTION 18

FIG 2-9 MODEL 9933 REMOTE CONTROLLER CONNECTION 18

FIG 2-10 DIAGRAM OF ANALOG PROGRAMMING INPUT 19

FIG 2-11 ANALOG PROGRAMMING EXAMPLE 19

FIG 3-1 3305F FRONT PANEL 20

FIG 3-3 3305F REAR PANEL 21

FIG 3-4 EDIT MODE OPERATION FLOW CHART 30

FIG 3-5 TEST MODE OPERATION FLOW-CHART 32

FIG 4-1 RS232 INTERFACE CONNECTION OF REAR PANEL 33

FIG D2-1 77

Tables

| | |
|--|----|
| TABLE 1-1 3310F / 3330F / 3340F/G / 33401F/G SERIES SPECIFICATION LIST | 10 |
| TABLE 1-2 SPECIFICATIONS | 11 |
| TABLE 4-1 COMMAND TERMINATORS..... | 35 |
| TABLE 4-2 REMOTE CONTROL SETTING COMMAND SUMMARY | 37 |
| TABLE 4-3 REMOTE CONTROL QUERY COMMAND SUMMARY..... | 38 |
| TABLE 4-4 REMOTE CONTROL LIMIT COMMAND SUMMARY | 39 |
| TABLE 4-5 STAGE COMMAND SUMMARY | 40 |
| TABLE 4-6 SYSTEM COMMAND SUMMARY | 40 |
| TABLE 4-7 MEASURE COMMAND SUMMARY..... | 40 |
| TABLE 4-8 GLOBE COMMAND SUMMARY | 41 |
| TABLE 4-9 AUTO SEQUENCE COMMAND LIST | 46 |
| TABLE 4-2B REMOTE CONTROL SETTING COMMAND SUMMARY | 48 |
| TABLE 4-3B REMOTE CONTROL QUERY COMMAND SUMMARY | 50 |
| TABLE 4-4B REMOTE CONTROL LIMIT COMMAND SUMMARY | 50 |
| TABLE 4-5B STAGE COMMAND SUMMARY | 52 |
| TABLE 4-6B SYSTEM COMMAND SUMMARY..... | 52 |
| TABLE 4-7B MEASURE COMMAND SUMMARY | 52 |
| TABLE 4-8B GLOBE COMMAND SUMMARY | 52 |
| TABLE 4-9B AUTO SEQUENCE COMMAND LIST..... | 53 |
| TABLE 4-10 MODULES FOR EACH SERIES | 64 |
| TABLE 4-11 ERROR REGISTER | 66 |
| TABLE 4-12 REGISTER OF PROTECTION STATUS | 67 |
| TABLE 4-13 MODEL NUMBER | 69 |

Chapter 1 Introduction

The 3305F electronic load mainframe is required to provide the DC power conversion and optional computer communications to the 'F' series of Load Modules. The 3305F is designed to house any of the following models:



| Model | Max. current | | Max. voltage | | Max. power | |
|--------|--------------|-----------|--------------|-----------|------------|-----------|
| 3310F | 30A | | 60V | | 150W | |
| 3311F | 60A | | 60V | | 300W | |
| 3312F | 12A | | 250V | | 300W | |
| 3314F | 12A | | 500V | | 300W | |
| 3315F | 15A | | 60V | | 75W | |
| 3330F | 60A(CHA) | 6A(CHB) | 80V(CHA) | 80V(CHB) | 250W(CHA) | 50W(CHB) |
| 3332F | 24A(CHA) | 24A(CHB) | 80V(CHA) | 80V(CHB) | 120W(CHA) | 120W(CHB) |
| 3336F | 3A(CHA) | 3A(CHB) | 80V(CHA) | 80V(CHB) | 40W(CHA) | 40W(CHB) |
| 3340F | 2A | | 300V | | 150W | |
| 3341F | 20A | | 100V | | 300W | |
| 3342F | 2A | | 500V | | 300W | |
| 33401F | 2.4A(CHA) | 2.4A(CHB) | 500V(CHA) | 500V(CHB) | 120W(CHA) | 120W(CHB) |
| 3341G | 24A | | 300V | | 300W | |
| 3342G | 12A | | 500V | | 300W | |
| 3343G | 24A | | 500V | | 300W | |
| 33401G | 6A(CHA) | 6A(CHB) | 500V(CHA) | 33401G | 6A(CHA) | 6A(CHB) |

TABLE 1-1 3310F / 3330F / 3340F/G / 33401F/G SERIES SPECIFICATION LIST

1.1 Features

The 3305F has the following key features:

- 1.1.1. Flexible Configuration: The 3305F can be used to house a variety of 'F' Series load modules with different voltage and current sink ranges.
- 1.1.2. Plug in Design: It is quick and easy to take a load module out of the Mainframe and to replace it with another load module.
- 1.1.3. Computer Interfaces: GPIB, RS232, USB or LAN are optionally Available for remote control. The mechanical design of the interface cards.
- 1.1.4. Front panel memory: Common test settings can be stored and recalled.
- 1.1.5. Auto Sequence: Memory locations can be linked to form a sequence Against time.
- 1.1.6. Wake Up Function: The mainframe can be set to automatically revert to a Load set up on mains power on.
- 1.1.7. Intelligent Cooling: Temperature controlled fans are used to minimise

1.2 Standard Accessories

The following accessories are provided as standard:

- 1.2.1. Model 3305F
- 1.2.2. BNC-BNC cable 1m
- 1.2.3. Model 3305F Operation Manual 1PC
- 1.2.4. 3Pin Power cable 1PC

1.3 Option

- 1.3.1. GPIB+RS232 interface
- 1.3.2. RS232 interface
- 1.3.3. GPIB interface
- 1.3.4. USB interface + USB DRIVER CD
- 1.3.5. LAN interface + LAN DRIVER CD
- 1.3.6. 9933 Remote Controller 1 PC
- 1.3.7. GPIB cable 1 M
- 1.3.8. GPIB cable 2 M
- 1.3.9. USB TYPE A TO TYPE B cable 1.8 M

1.4 Specifications

The specification of 3305F mainframe is shown below in Table 1-2.

| | | | |
|--------------------|------------------------|----------------------|------------------------|
| AC INPUT | LINE | 100V/115V±10% | 200V/230V±10% |
| | FREQUENCY | 50/60 HZ | |
| | FUSE | T1A/250V (5*20mm) | T0.5A/250V (5*20mm) |
| | MAX. POWER CONSUMPTION | 60 W | |
| DIMENSIONS (W*H*D) | | 150 mm*177 mm*445 mm | |
| WEIGHT | | NET : 7.5 Kg | |

TABLE 1-2 SPECIFICATIONS

Chapter 2 Installation

2.1 Inspection

The 3305F mainframe was carefully inspected, tested and calibrated before shipment. If damage to the instrument has occurred during transport, please inform Prodigit's sales and service office or representative. Your 3305F mainframe was shipped with a power cord for the type of outlet used at your location. If the appropriated cord was not included, please contact your nearest sales office to obtain the correct cord. Refer to "check line voltage" to check the line voltage selection and fuse type.

2.2 Check line voltage

The 3305F mainframe can be operated from a 100/115 or 200/230Vac input as indicated on the label on the rear panel. The input is switchable so please make sure that the switch is set correctly for your nominal mains input before turning on the mains power. The procedure below details how to change the switch position:

- 2.2.1 With the 3305F mainframe power OFF, disconnect the power cord.
- 2.2.2 Refer the drawing on the rear panel in Fig 2-1, set the switches to the Proper voltage as described in the following:
 - a. Set Switch to 100V/115V for 115Vac line voltage
 - b. Set Switch to 200V/230V for 230VacNote: 100Vac and 200Vac is used for Japan only (Option)

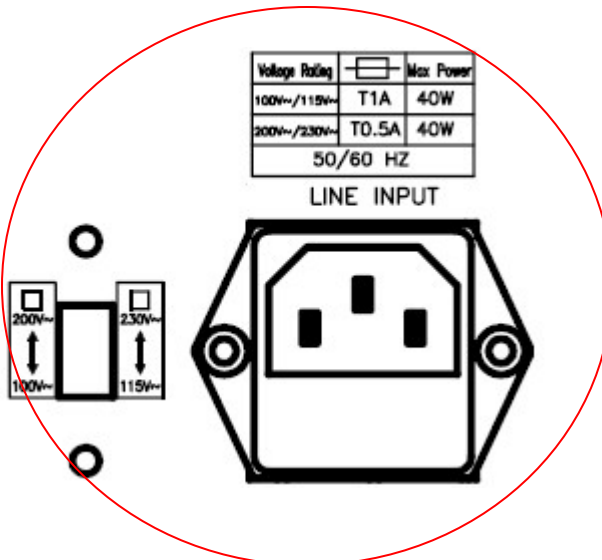

Fig 2-1 SET OF SWITCH

2.3 Input Fuse

This product is fitted with a mains input fuse. If it needs to be replaced please adhere to the Following procedure.



BEFORE replacing the fuse you must switch off the unit and mains power outlet and disconnect the plug of the AC Power cable from the input socket of the 3305F.



If prior to exchanging the fuse, there is any abnormal noise or odour do not use the unit. Please inform your local sales office to organise repair of the 3305F.

To avoid the risk of fire or electronic shock the fuse must only be replaced with same type and rating as the original. Any replacement fuse used should meet your national safety standards. Any use of improper fuse or shorting the Fuse holder would be extremely dangerous and would be strictly prohibited.

- 2.3.1 Check the rating of the mains input fuse. Replace only with the correct Type and rating.
For 100V/115Vac Input use T1A/250V (5*20mm),
For 200V/230Vac Input use T0.5A/250V (5*20mm)
- 2.3.2 The AC line fuse is located below the AC line socket (see Fig 2-2). Use A small screwdriver to remove the fuse holder. Replace the failed fuse With the appropriate type and rating according to your mains voltage. (See Table 1-2)
- 2.3.3 Refit the fuse holder and connect the power cord.

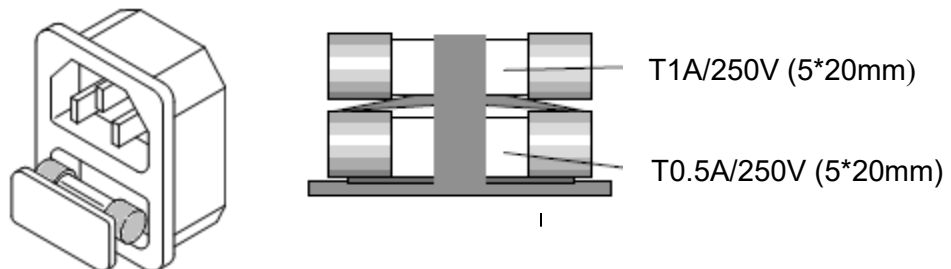

Fig 2-2 FUSE RECEPTACLE

2.4 Grounding requirements



SHOCK HAZARD

The unit is grounded via the AC Input. It must be ensured that the correct mains lead with earth pin is used. Correct grounding of your electrical system infrastructure according to national standards must also be observed.

2.5 Environmental Requirements

- Indoor use.
- Insulation Category I.
- Pollution Degree 2.
- Altitude up to 2000 meters
- Relative Humidity 80% Max (non-condensing).
- Ambient Temperature 0 to 40°C
- The ideal operating temperature is 25°C ± 5°C

2.6 Observe the International Electrical Symbol Listed Below

 Warning ! Risk of electric shock.

 Caution ! Refer to this manual before using the instrument.

2.7 Cleaning

To clean this product uses a soft or slightly damp cloth.



BEFORE you clean the unit, switch the mains power off and disconnect the input lead.

- Please do NOT use any organic solvent capable of changing the nature of the plastic such as benzene or acetone.
- Please ensure that no liquid is allowed to penetrate this product

2.8 Observe precautions for handling electrostatic sensitive devices

Analog Programming Input is ESD (electrostatic discharge) sensitive device. Electrostatic charges as high as 4000V readily accumulates on the human body and test equipment and can discharge without detection.

Although the features proprietary ESD protection circuitry, permanent damage may occur on devices subjected to high energy electrostatic discharges.

Therefore, proper ESD precautions are recommended to avoid performance degradation or loss of functionality.

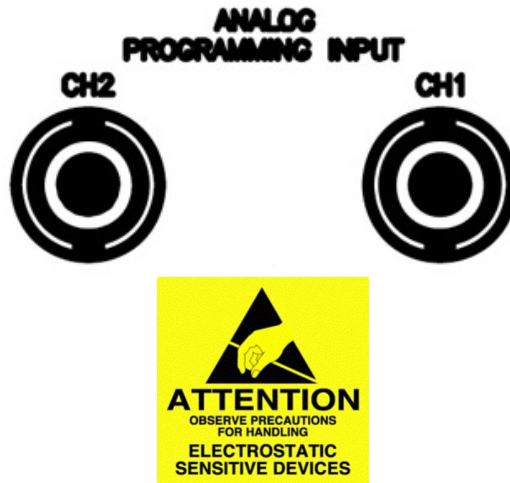

2.9 Power Up

The following procedure should be followed before applying mains power:

- Check that the POWER switch is in the off (O) position
- Check the rear panel voltage selector of the 3305F is correctly set.
- Check that nothing is connected to the DC INPUT (load input terminals) on The front and rear panels.
- Connect correct AC mains lead to the 3305F
- Turn on (I) the POWER switch.

2.10 GPIB & RS232 connection option

If your 3305F is fitted with GPIB + RS232 interface card then the rear panel will have the necessary interface sockets as shown in Fig 2-3. This connects the 3305F mainframe to RS232 or GPIB port of your computer.

GPIB and RS232 interface can only be used at the same time, to Change the interface must reboot unit.



Fig 2-3 3305F REAR PANEL

The RS232 BAUD-RATE can be set in the front panel of the 3305F. Press the “SYSTEM” button twice to enter the BAUD RATE adjustment.

A GPIB system can be connected in any configuration (star, linear, or both) as long as

- The maximum number of devices including the controller is no more than 15.
- The maximum length of the GPIB cable is no more than 2 meters.
- The total lead length of all devices connected together total <20 meters

2.11 RS232 Interface Option

Fig 2-4 shows the RS232 connector (Female) on the rear panel. This connects the 3305F mainframe to RS232 port of computer. The RS232 BAUD-RATE can be set in the front panel of the 3305F. Press the “SYSTEM” button twice to enter the BAUD RATE adjustment.



Fig 2-4 3305F RS232 Connection

2.12 GPIB connection option

The GPIB connector is located on the rear panel. This socket allows the 3305F to be connected to the controller and other GPIB devices. A GPIB system can be connected in any configuration (star, linear, or both) as long as

- The maximum number of devices including the controller is ≤ 15 .
- The maximum length of the GPIB cable is no more than 2 meters times.
- The total lead length of all devices connected together total < 20 meters.
- Please make sure the lock screws are firmly hand-tightened, use a Screwdriver only for the removal of screws. Fig 2-5 shows the rear Panel of 3305F mainframe, The GPIB address of the 3305F mainframe is set on Front panel.

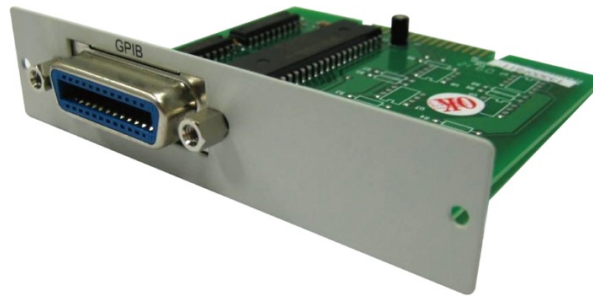

Fig 2-5 3305F REAR PANEL

2.13 USB Connection Option

Fig 2-6 shows the USB connector in the rear panel of 3305F mainframe. Please refer Appendix B.

The USB card chip PL2303TA only supports operating systems before Win10 (Including).

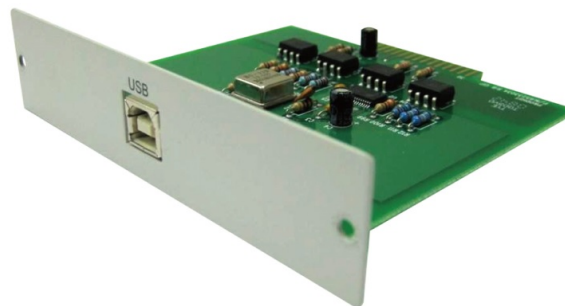

Fig 2-6 3305F USB Connection

2.14 LAN Connection Option

Fig 2-7 shows the LAN connector in the rear panel of 3305F mainframe. Please refer Appendix C.



Fig 2-7 3305F LAN Connection

2.15 Remote Controller Option

A wired remote controller (P/No: 9933) can be connected to the mainframe. Fig 2-8 shows the remote controller socket which is located on the rear panel.

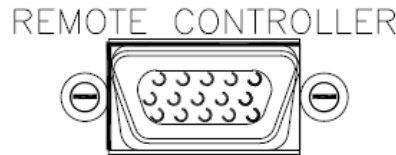

Fig 2-8 3305F Remote controller Connection

2.16 Remote Controller Connection

Fig 2-9 shows pin assignments for the DSUB-15 connector when the remote controller option is fitted to the 3305F mainframe. The remote controller allows the first 10 memory locations to be recalled. Set ups saved at these memory locations can include dynamic waveforms and the load ON state.

Note 1: O/P as a set of NG TTL High level signal output.

Note 2: The Load button on the remote controller does not operate for The 3302F/3305F mainframes, However the Load ON state can be saved as part of The set up stored in one of the memory locations.

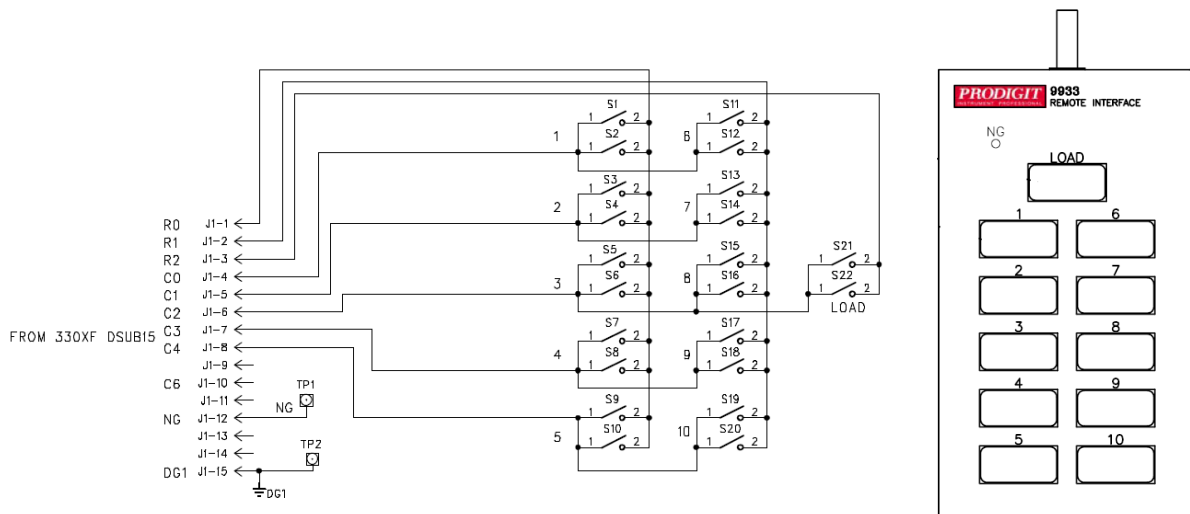

Fig 2-9 Model 9933 Remote controller Connection

2.17 Analog Programming Input

The 3305F mainframe has an analogue programming input. This feature allows an external waveform to be tracked as long as it is within the load's dynamic capabilities. The analogue programming input is configured as a BNC socket. It will accept a 0-10V signal. This signal is proportional to the load module's maximum current range. Please note that the analogue programming input will only operate with single channel load modules. It cannot be used for dual channel load modules from the 3330F series and 33401F/G.

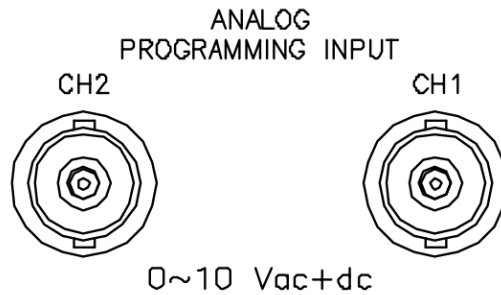

Fig 2-10 Diagram of analog programming input

The analogue programming input operates in CC or CP modes only. The Load Module will attempt to load proportionally according to the signal and the load module's maximum current or power range.

For example: 3311F: $I_{max} = 60A$ and $P_{max} = 300W$

So in CC mode if analogue programming input is 5V = 30A load setting
Or in CP mode if analogue programming input is 1V = 30W load setting

The analog programming signal can act alone or it can be summed with the programmed value set via the front panel or the optional computer interface (GPIB, RS232, USB, or LAN) or the front panel.

Example:

Fig 2-11 shows the result of an analog programming signal at 4Vac, 500Hz when it is summed with a 24A programmed setting in CC mode of 3311F Load module.

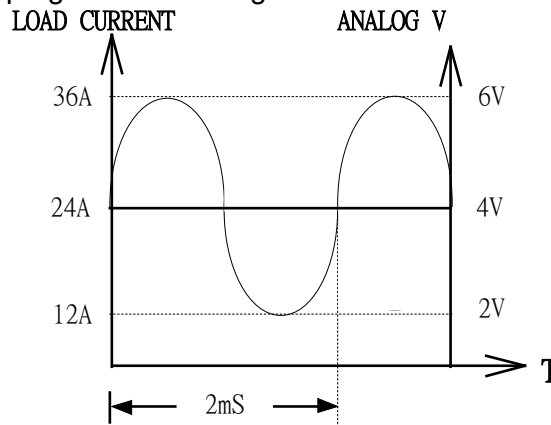

Fig 2-11 Analog Programming Example

Chapter 3 Mainframe Operation

The front panel of 3305F mainframe is shown in Fig 3-1.

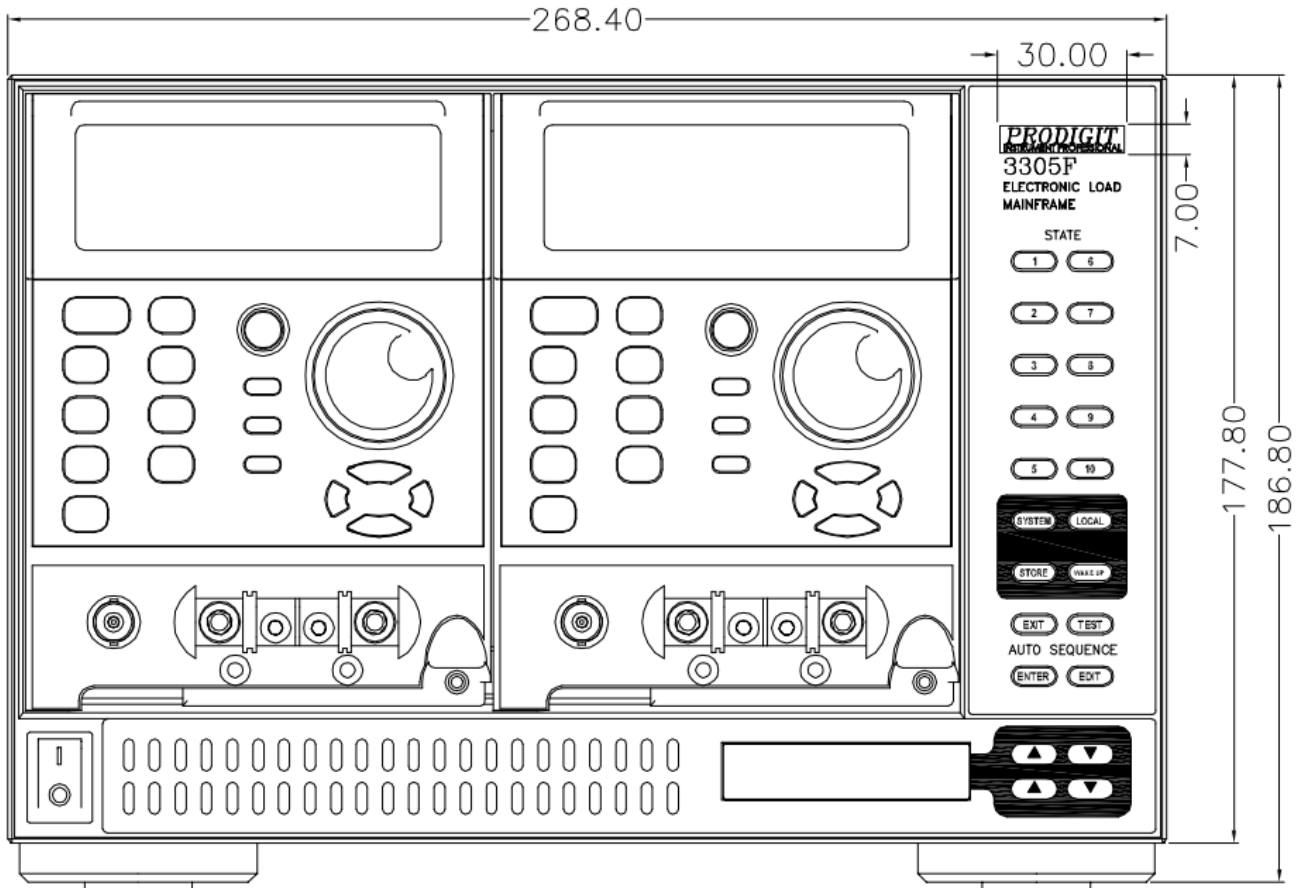

Fig 3-1 3305F FRONT PANEL

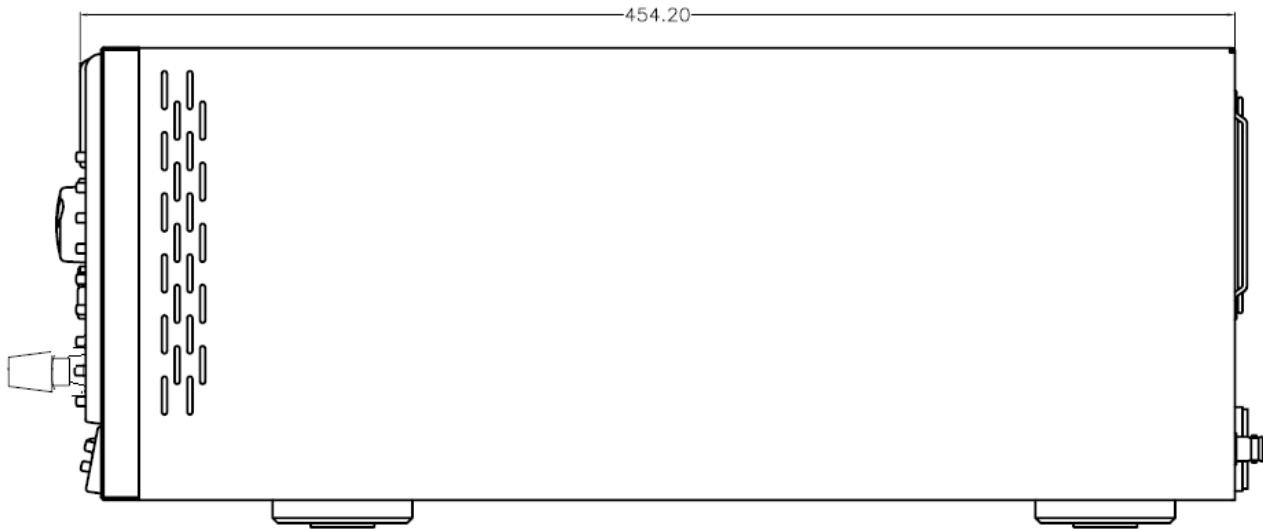

Fig 3-2 3305F SIDE PANEL

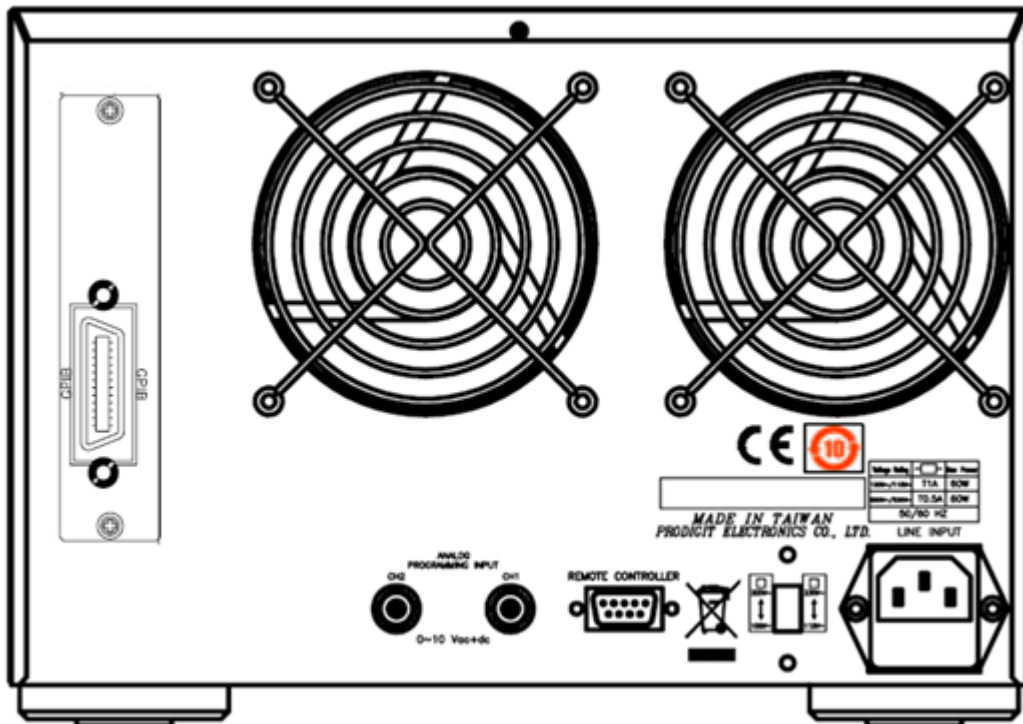

Fig 3-3 3305F REAR PANEL

3.1 Power Switch

Before switching on the unit please ensure the mains voltage matches the units setting (see Section 2.2 Check Line Voltage)

At mains power ON, the following should be apparent.

- 3.1.1. The mainframe and firmware version is displayed on its screen at the bottom right.
- 3.1.2. If a load module is fitted it's LCD will become lit and display its firmware version
- 3.1.3. If no load module is fitted the fan will not operate. If a load module has been installed The fan will turn slowly. The fan will speed up under load.

3.2 LCD

The mainframe's LCD will illuminate fully at mains power ON.

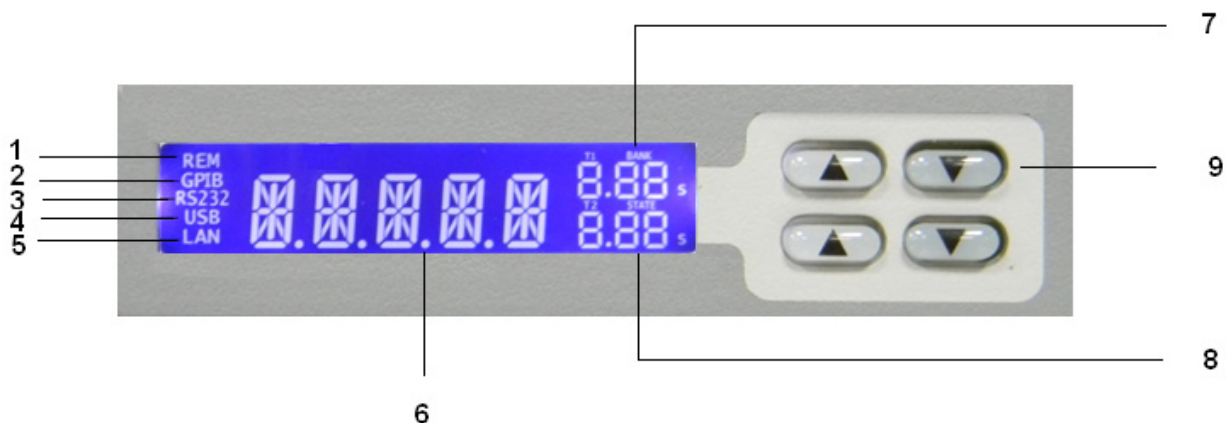

Please refer to the relevant section below as indicated by the number assigned to a front panel Function. For example the arrow buttons are labeled 9 so for more information please refer to 3.2.9 in the following section.

3.2.1 REMOTE mode

The REM will be lit when 3305F is being controlled via the GPIB/RS232/USB or LAN -Interface. To bring back the unit to front panel control the local button on the Right hand side of the mainframe can be pressed.

3.2.2 GPIB Card

The LCD will permanently show GPIB if this computer interface has been fitted.



3.2.3 RS232 Card

The LCD will permanently show RS232 if this computer interface has been fitted.



3.2.4 USB Card:

The LCD will permanently show USB if this computer interface has been fitted.



3.2.5 LAN Card

The LCD will permanently show LAN if this computer interface has been fitted.



3.2.6 3305F Main Display

At mains power on the LCD will display Nor. This means Normal. The message Will change if a setting function such as WAKE UP or AUTO-SEQUENCE has Been selected.



3.2.7 BANK/T1 Display

The upper digits on the right hand side of the screen relate to the memory BANK in normal mode. There are 15 BANKS which can be selected in turn by pressing the upper pair of arrow keys. Each BANK has 10 memory separate memory STATES (locations) which are selected with the lower pair of arrow keys.

When in auto-sequence mode T1 is displayed. T1 is the test time. The test time Can be adjusted using the upper arrow keys between 0.1sec and 9.9sec in 100ms Steps. Please note that during the T1 test time the mainframe LCD will not flag NG. The T2 setting is used for checking the NG function according to the voltage, Current or power limits set via the LIMIT menu.

3.2.8 STATE/T2 Display

The lower digits relate to the memory STATE (location) in normal mode. There are 10 memory STATES (locations) which can be selected in turn by pressing the Lower arrow keys. These memory STATES are supplemented by 15 memory BANKS giving the user 150 memory locations in total.

When in auto-sequence mode the T2 function is displayed. T2 is the time that NG/GO is checked according to the LIMITS that have been set for that test step.

So if the NG flag has been enabled and the load measures values outside the preset LIMIT values then the test will stop during T2. The mainframe's LCD will flash NG and the test will stop at that step in the auto-sequence. The user can then press ENTER to carry on to the next step or EXIT to leave the auto-sequence.

3.2.9 Arrow buttons

The ARROW key is used to increase or decrease the set values.

3.3 Buttons Description

This section briefly describes the buttons on the right hand side of the mainframe. Their functional use is further described in section 3.4.

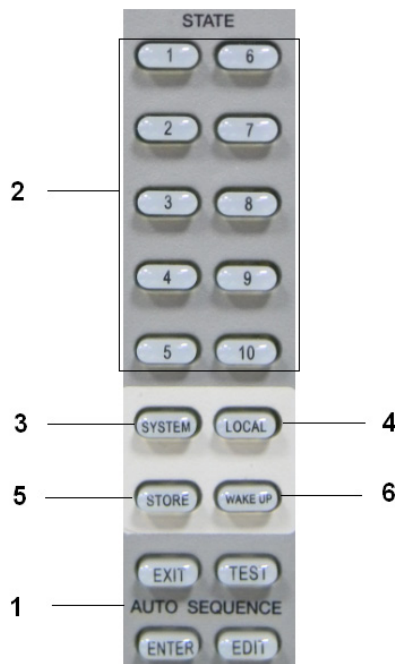

- 3.3.1 The 4 buttons marked exit, test, enter and edit are used to set an auto-sequence.
- 3.3.2 The numbered buttons 1~10 are the memory states (locations) for storing or Recalling a load set up. They are also used to select a previously saved Auto-sequence when in test mode
- 3.3.3 Pressing the system button once allows the GPIB address to be changed by using The arrow keys. Pressing the system button again allows the RS232 baud rate to Be adjusted. With the third press of the system button the buzzer can be switched On/off. Another press puts the LCD back to Normal state as shown below.

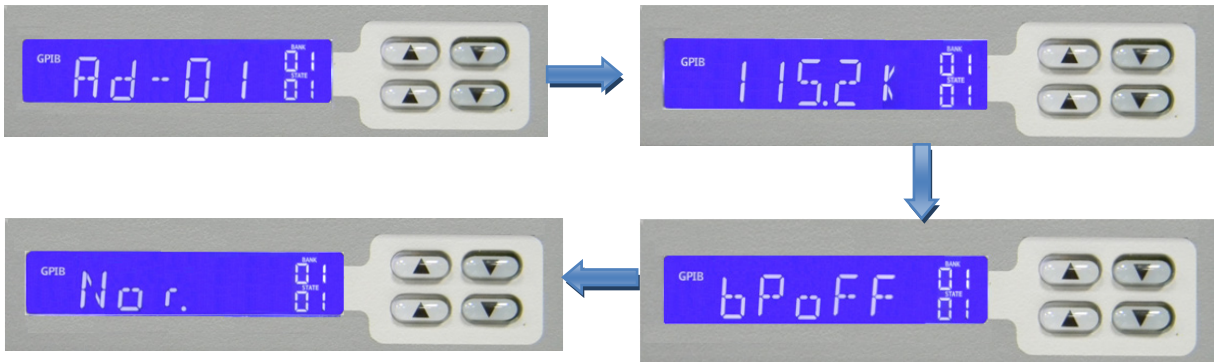

- 3.3.4 The local button is used to exit the remote mode and bring the unit back to front Panel control.
- 3.3.5 The store button is used to save the load configuration
- 3.3.6 The wake up button is used to recall the load configuration at mains power on.

3.4 Operating Instructions

3.4.1. Setting System Parameters

The system button allows the setting of:

- GPIB address
- RS232 BAUD RATE
- Buzzer ON/OFF

- 3.4.1.1. To set the GPIB address you must press the system key once. The LCD will Display the current address. The arrow keys are used to change the address. Once the required address is reached press enter or store button to save the New address. The exit key can be pressed to return to the normal screen.

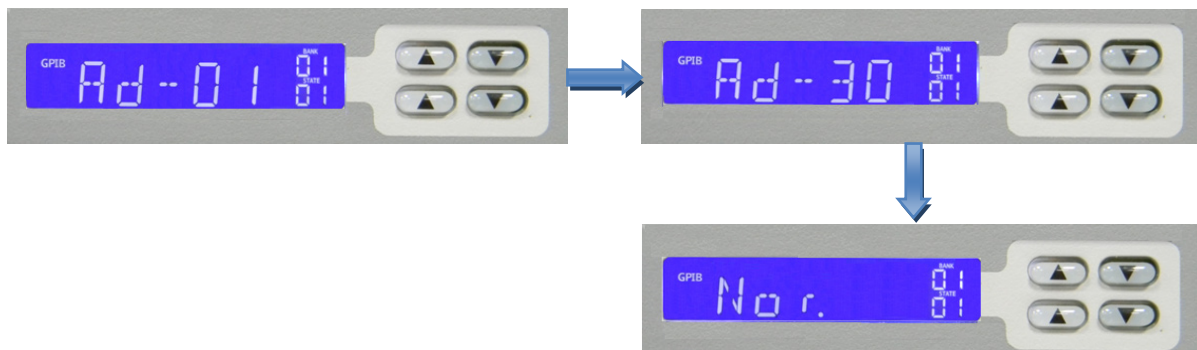

3.4.1.2. To set the RS232 baud rate you must press the system key twice. The LCD will Display the current baud rate. The upper arrow keys are used to change the baud rate. Once the required value is reached press enter or store button to save the new setting. The exit key can be pressed to return to the normal screen.

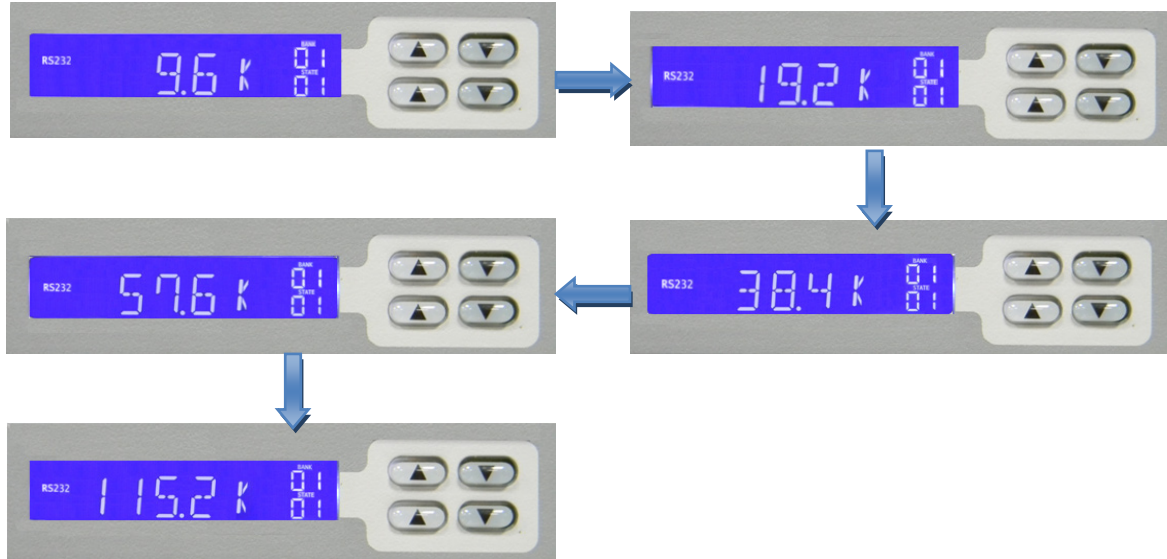

3.4.1.3. To set the buzzer on/off you need to press the system key 3 times. The arrow Key is used to change the buzzer state. The buzzer can be used to signal that An automatic sequence has ended or failed. To save the setting press enter or Store.



3.4.2. STORE/RECALL Operation

The function keys on the front panel of 3305F mainframe, 3310F / 3330F / 3340F/G / 33401F/G series electronic load modules 3305F STORE/RECALL Ten electronic load STATE Setting items and 15 BANK a total of 150 electronic load state set, each state can store a variety of electronic load status and settings.

| | 331XF | 333XF | 334XF/G | 33401F/G |
|--------------------------------------|-------|-------|---------|----------|
| BANK(n) | 15 | 15 | 15 | 15 |
| STATE(m) | 10 | 10 | 10 | 10 |
| TOTAL STATES ((Memory locations) | 150 | 150 | 150 | 150 |

3.4.2.1. How to STORE a load set up:

1. Adjust Electronic Load to desired status and settings.
2. With the UP and DOWN keys on the mainframe select the bank (1 to 15) in which you will store the set up
3. Press the store key on the mainframe. The store key starts flashing. (If you no longer wish to store a setting you can press the exit button or Wait about 20 seconds for the unit to automatically exit the store Operation).
4. While the store light is flashing press a one of the number keys (1 to10) Where the set-up is to be saved. The store light will go out and the Numbered key pressed will stay illuminated. This indicates the set-up Has been saved to that location.

3.4.2.2. How to RECALL a saved set up.

First select the memory bank by using the up and down arrow buttons. Pressing one of the numbered state buttons will recall the previously saved load configuration. The electronic load will immediately switch to the previously saved set-up changing the load values, operation mode and limits accordingly.

3.4.3. WAKE-UP Function

The wake up function is designed to automatically recall a setting at mains power on.

- Step 1 Press WAKE UP once or twice so that message SET is displayed on the 3305F LCD.

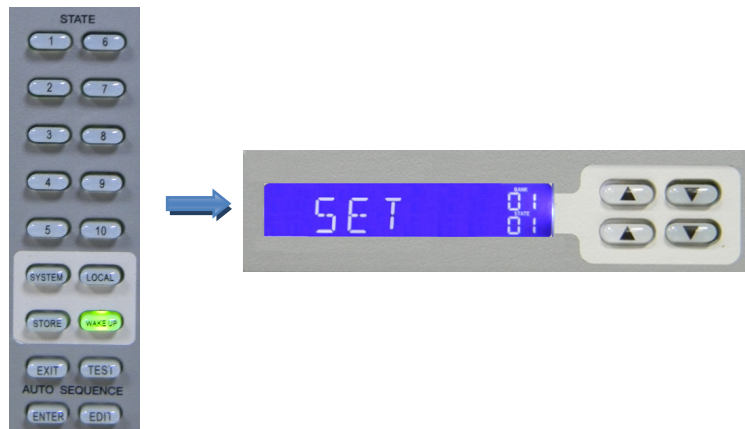

- Step 2 Select the memory location (bank and state) that is to be used. Once the Correct location has been selected press the STORE key. This example below Shows bank 01 state 01. After pressing store key the LCD will revert to the Normal message.

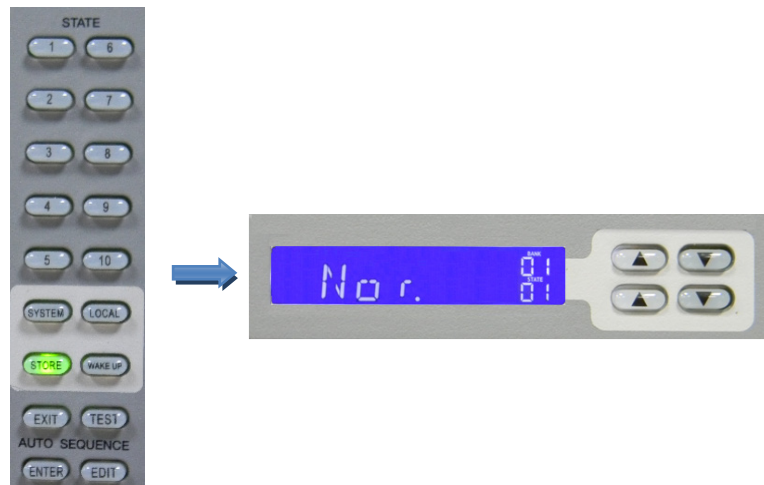

- Step 3 Use the mains switch on the front panel to power down the unit.
- Step 4 At mains power on the unit will automatically recall the previously saved Set-up from the nominated memory location.
- Step 5 To clear the settings, press the wake up key once or twice so that the LCD Shows clear. Now press them STORE key to cancel the previously set Wake up function.

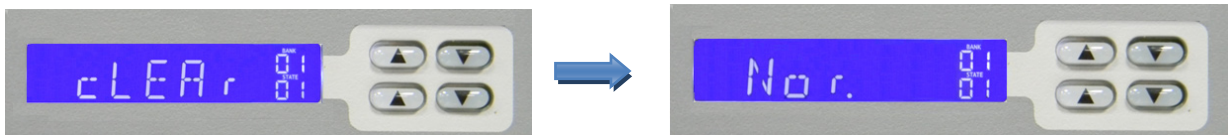

3.4.4. AUTO-SEQUENCE

An auto-sequence allows the user to step through previously saved set-ups stored in the mainframe's memory. Up to 9 auto-sequences can be saved. Each auto-sequence can consist of up to 16 steps. There are two modes in the auto-sequence function. These are edit mode and test mode.

3.4.4.1 Edit Mode

1. Press EDIT key, then EDIT button will become lit and the LCD will display "FX-XX". This is defined as follows:

The "FX" part indicates the auto-sequence number (F1 to F9 are possible). The numbered STATE keys are Used to select the auto-sequence number
The "XX" part is the test step (1 to 16 is possible).

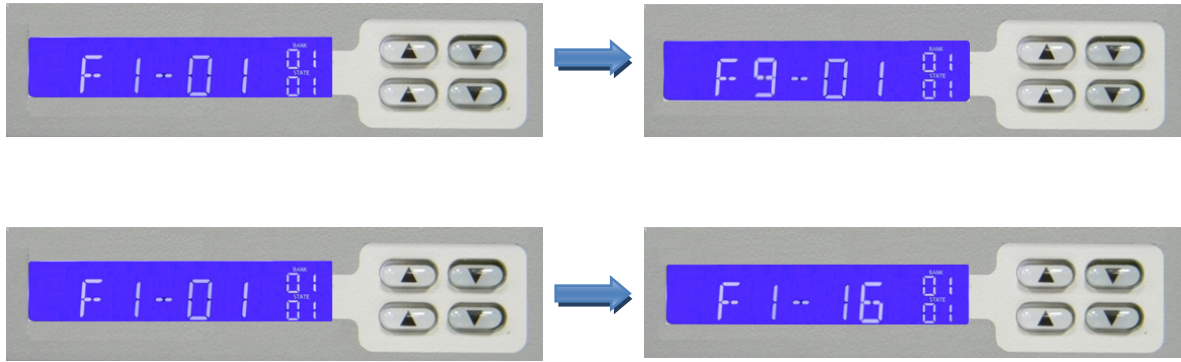

2. Once the auto-sequence number has been selected the Memory location of the first test step can be selected. The Arrow keys next to the 3305F LCD are used to select the Memory BANK and memory STATE.

Once the desired location has been selected press ENTER

Next the total test time for that step (T1+T2) can be entered. T1 is the test time without checking the NG/LIMIT settings. T2 is the test time where if NG is ON the LIMIT settings will be checked. The upper arrow keys are used to set T1 and the lower arrow keys are used to set T2. The time setting can be adjusted in the range of 0.1s to 9.9s in 100ms Increments. Please see sections 3.2.7 and 3.2.8 for a Definition of T1 and T2.



3. Press ENTER to set the next setting step. Repeat the same Process for each setting steps. Up to 16 steps can be Entered.

Once the T1 and T2 settings have been entered for the final Step press the STORE button. The LCD will now show REP.

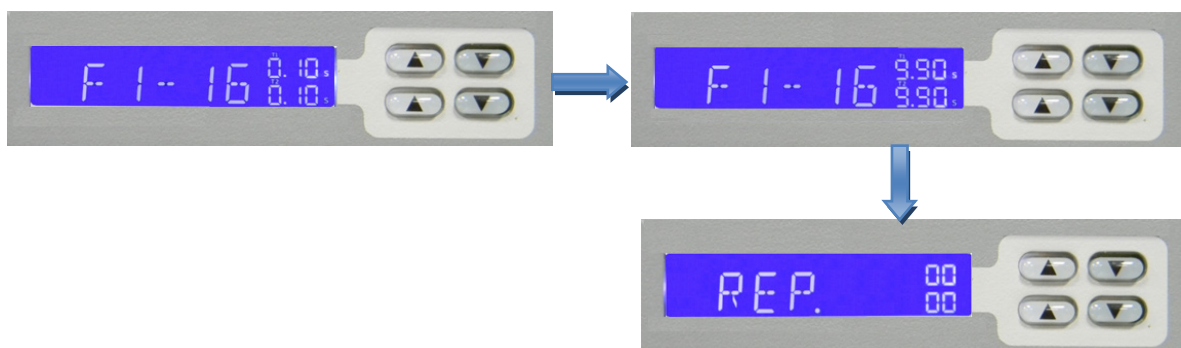

- The REP function allows the auto-sequence to be repeated a number of times. Both sets of arrow keys are used to set The number of repeats between 0 and 9999 times. Once the Number of repeats has been set press the STORE button to Save the auto-sequence.

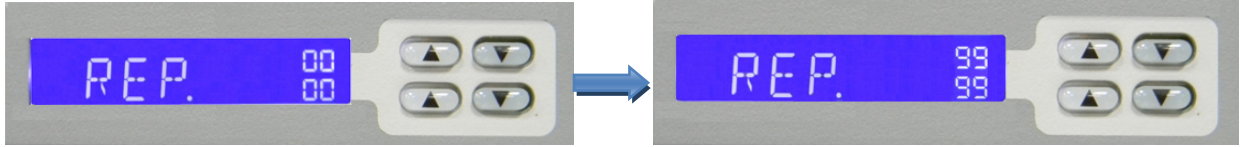

Example: The following screen shot shows the Number of repetitions has been set to 2023

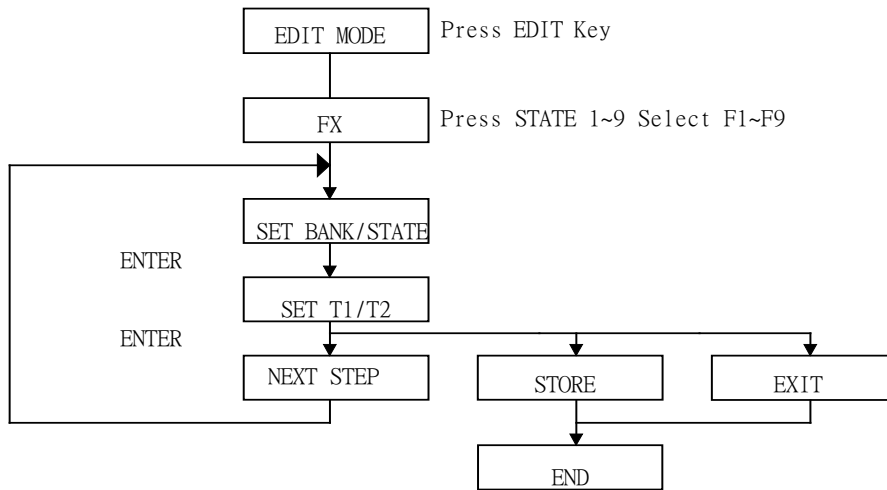
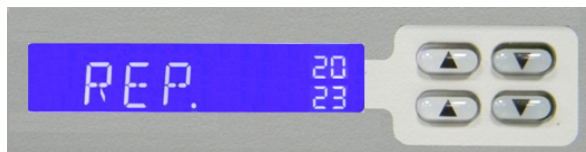
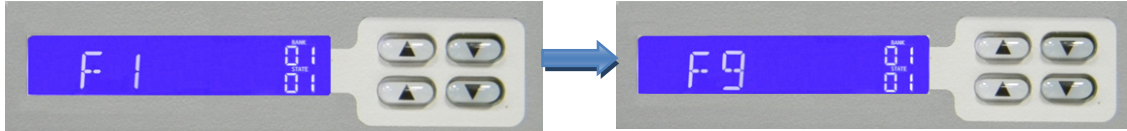

Fig 3-4 EDIT MODE OPERATION FLOW CHART

3.4.4.2 Test Mode

1. Pressing the TEST button will cause the TEST switch to illuminate and the LCD to show the last selected Auto-sequence number (F1 to F9).

The numbered STATE buttons (1-9) are used to change the Auto-sequence number (F1 ~ F9). Once the desired Auto-sequence has been selected press ENTER to start the Test.



2. The LCD will display "SXX", where "XX" is the actual STEP being Presently tested. If during a given test step the values measured Are outside the preset limits (and the NG Function has been enabled) then the LCD will flash "NG" And the test is suspended.

The user can press the ENTER button to continue the Remaining test steps. Alternatively the EXIT button can be Used to leave the test mode.

3. If all the test steps are OK, the LCD displays "PASS". If the Unit under test fails any of the test steps the mainframe's LCD will show "FAIL".

If the buzzer is set to ON, the PASS result is also Accompanied by a single buzzer call out. If the test shows FAIL the buzzer will sound twice.

4. When the test is completed, the user can press the ENTER Key again to start the test again. Alternatively the EXIT Button can be used to leave the test mode.

Example 1: Once the editing of the 16 step test is completed, press the TEST key. The unit Will then automatically run through the test steps S01 to S16 in order. If all tests Steps have been completed then the LCD will show PASS.

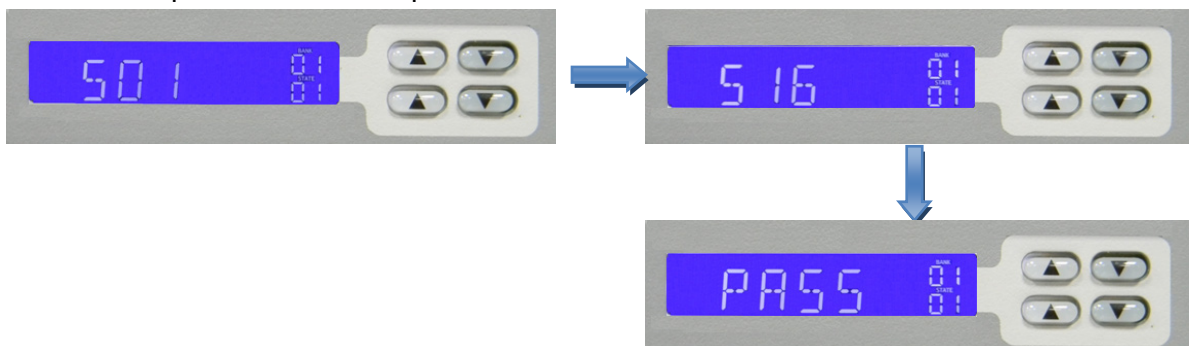

Example 2: Once the edit mode has been used to set the 16 step auto-sequence the user Can press the TEST key. If the test fails at one of the test steps the LCD will flash “NG” and the test will stop. The user can then press ENTER key to continue the Test or press the EXIT button to leave the test mode.

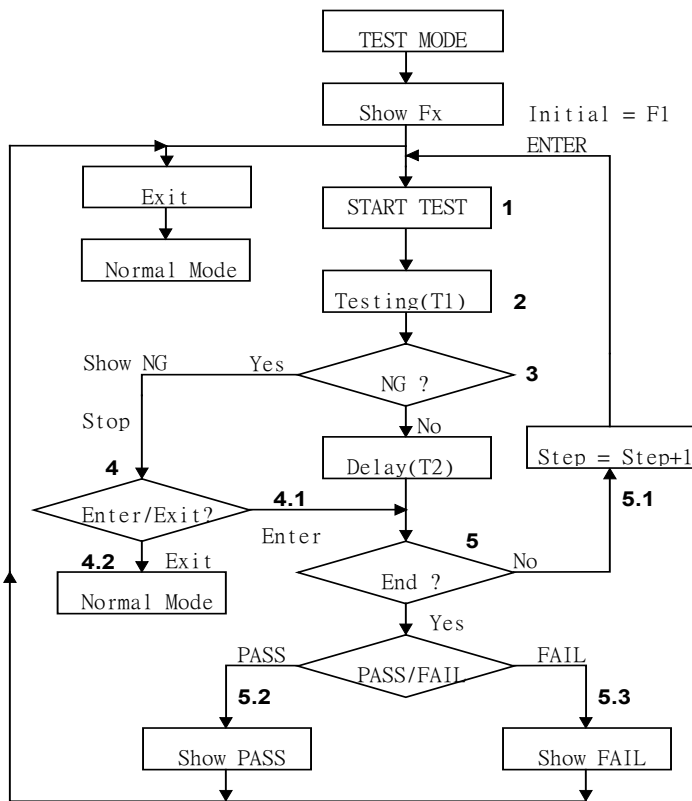
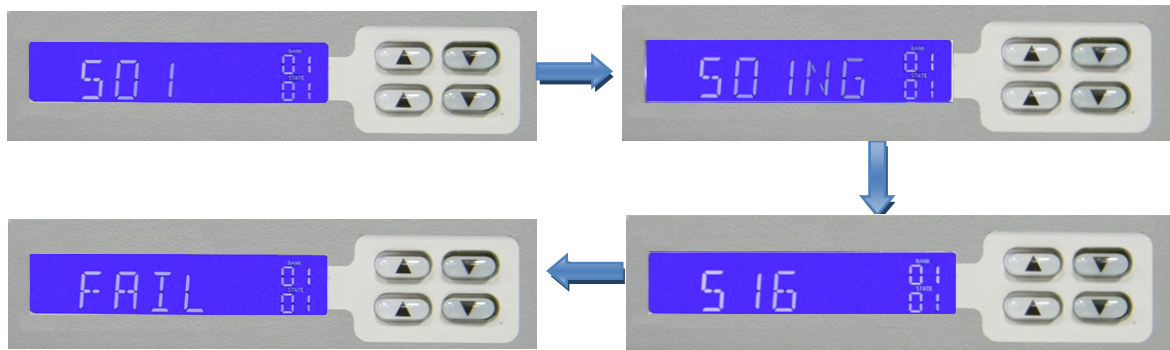

1. Press TEST key
 2. Press STATE 1-9 Select F1-F9
 3. Press ENTER
1. Recall correspond memory which had been stored in F1-F9 memory
 2. Check the GO/NG indicator
 3. Stop testing if the result was NG.
 - 3.1 Press ENTER to be continued.
 - 3.2 Press EXIT to end the test, and back to normal mode.
 4. If test is GO, than step is last?
 - 4.1 If no than Step+1, continue another step
 - 4.2 If "Yes", than if all the test in all module is pass, show GO
 - 4.3 If "Yes", thanif there is at least one failure during the test, show NG

Fig 3-5 TEST MODE OPERATION FLOW-CHART

Chapter 4 Remote control programming operation

4.1. Introduction

If your unit is fitted with a computer interface option then a GPIB, RS232, USB or LAN socket will be present on the rear panel according to what was ordered. The interface allows the load settings to be configured remotely and measurements read back.

There are two sets of programming terms for the 3305F. One is referred to as the SIMPLE format and the other is COMPLEX format.

4.2. RS232 Set-up

The RS232 interface of the 3305F mainframe is set up as follows.

Baud-rate : 9600~115200bps
 Parity : None
 Data bit : 8 bits
 Stop bit : 1 bit
 Handshaking : Hardware (RTS/CTS).

The RS232 Interface connector of 3305F rear panel, RS232 is shown in Fig4-1.

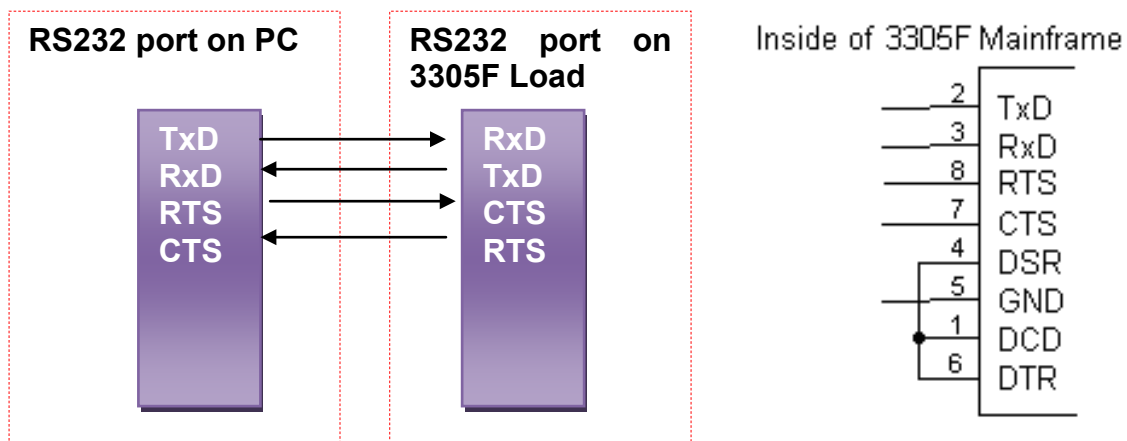
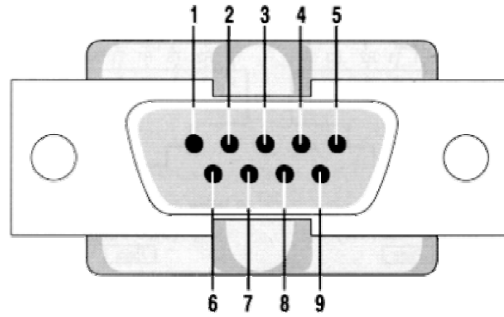

Fig 4-1 RS232 INTERFACE CONNECTION OF REAR PANEL



| PIN | Abbreviation | Description |
|------|--------------|---------------------|
| Pin1 | CD | Carrier Detect |
| Pin2 | RXD | Receive |
| Pin3 | TXD | Transmit |
| Pin4 | DTR | Data Terminal Ready |
| Pin5 | GND | Ground |
| Pin6 | DSR | Data Set Ready |
| Pin7 | RTS | Request To Send |
| Pin8 | CTS | Clear To Send |
| Pin9 | RI | Ring Indicator |

PC RS232 Port

4.3. Programming Syntax, Parenthesis & Terminators

A variety of indicators are used in the description of the computer commands and in the Summary tables. The syntax used is defined as follows:

- **SP** : Space, the ASCII code is 20 Hexadecimal.
- **;** : Semicolon, Program line terminator, the ASCII code is 0A Hexadecimal.
- **NL** : New line, Program line terminator, the ASCII code is 0A Hexadecimal.
- **NR2** : Digits with decimal point. It can be accepted in the range and format of **###.#####** For example: 30.12345. In this instance the Load will read up to Five significant figures after the decimal point. The decimal point can be Omitted If not required.

4.3.1. Parenthesis

The following parenthesis are used in the command descriptions to indicate whether a Command is necessary or optional and whether a choice has to be made. The symbols { }, [], | or ? are not actually used in the programming script. The symbols { }, [] and | are Merely used to illustrate the nature of the contents.

{ } is Necessary : The contents of the { } symbol must be used as part of the Computer command, it cannot be omitted.

[] is Optional : The contents of the [] symbol indicates that the command is Optional. The use of the contents depends on the testing Application.

| is Necessary Choice: This symbol means a choice must be made between the stated commands. For example "LOW|HIGH" Means a LOW or HIGH choice needs to be made as part of the command.

? is Necessary Choice : Where a question mark is present it indicates that a choice Needs to be made. This maybe entering a numerical value That needs to be set

4.3.2. Terminators

You have to send the program line terminator character after sending a computer Command, the available command terminator characters that are accepted by the 3305F mainframe is listed in Table 4-1.

| |
|------------------|
| LF |
| LF WITH EOI |
| CR , LF |
| CR , LF WITH EOI |

TABLE 4-1 COMMAND Terminators

Semicolon ` ; ` The semicolon ` ; ` is a back-up command, the semicolon allows you To combine command statements on one line to create a command sequence.

4.4. Computer Commands: Simple Type Format

The setting and query commands for the 3310F / 3330F / 3340F/G / 33401F/G series of load modules when operated within the 3305F mainframe are listed below in table 4-1 and 4-2.

| SETTING PRESET NUMERIC COMMAND | MODEL | | | | REMARK |
|--|-------|-------|---------|----------|---|
| | 331XF | 333XF | 334XF/G | 33401F/G | |
| RISE{SP} {NR2} { ; NL} | V | V | V | | A/us(3310F,11F,12F), mA/us(3314F,15F,333XF 334XF/G) |
| FALL{SP}{ ; NL} | V | V | V | | A/us(3310F,11F,12F), mA/us(3314F,15F,333XF 334XF/G) |
| PERD : {HIGH LOW} {SP} {NR2} { ; NL} | V | V | V | | |
| LDONV{SP} {NR2} { ; NL} | V | V | V | V | |
| LDOFFV{SP} {NR2} { ; NL} | V | V | V | V | |
| CC CURR : {HIGH LOW} {SP} {NR2}{ ; NL} | V | V | V | | |
| CC CURR : {SP} {NR2}{ ; NL} | | | | V | |
| CP : {HIGH LOW} {SP} {NR2}{ ; NL} | V | V | V | | |
| CR RES : {HIGH LOW} {SP} {NR2}{ ; NL} | V | V | V | | |
| CR RES : {SP} {NR2}{ ; NL} | | | | V | |
| CV VOLT : {HIGH LOW} {SP} {NR2}{ ; NL} | V | V | V | | |
| CV VOLT : {SP} {NR2}{ ; NL} | | | | V | |
| TCONFIG {SP} {NORMAL OCP OPP SHORT }{ ; NL} | V | V | V | V | 33401F/G NO OPP |
| OCP:START {SP} {NR2}{ ; NL} | V | V | V | V | |
| OCP:STEP {SP} {NR2}{ ; NL} | V | V | V | V | |
| OCP:STOP {SP} {NR2}{ ; NL} | V | V | V | V | |
| VTH {SP} {NR2}{ ; NL} | V | V | V | V | |
| OPP:START {SP} {NR2}{ ; NL} | V | V | V | | |
| OPP:STEP {SP} {NR2}{ ; NL} | V | V | V | | |
| OPP:STOP {SP} {NR2}{ ; NL} | V | V | V | | |
| STIME {SP} {NR2}{ ; NL} | V | V | V | V | |
| | | | | | |
| | | | | | |

| SETTING PRESET NUMERIC COMMAND | MODEL | | | | REMARK |
|--------------------------------|-------|-------|---------|----------|----------------------------|
| | 331XF | 333XF | 334XF/G | 33401F/G | |
| VO{SP} {NR2} { ; NL } | | | V | V | |
| VD{SP} {NR2} { ; NL } | | | V | V | |
| RD{SP} {NR2} { ; NL } | | | V | V | |
| IO{SP} {NR2} { ; NL } | | | V | V | |
| RR{SP} {OFF NR2} { ; NL } | | | V | | |
| FREQ {NR1} ; ; NL } | | | V | V | 10-1000=10-1000Hz 0=DC |
| DIM:LEV {NR2} { ; NL } | | | V | V | DIM LEVEL,0-10V |
| DUTY {NR1} { ; NL } | | | V | V | 0.01-0.99=1-99% DUTY CYCLE |
| DIM {OFF ON} { ; NL } | | | V | V | 0 : OFF 1 : ON |

TABLE 4-2 REMOTE CONTROL SETTING COMMAND SUMMARY

| QUERY PRESET NUMERIC COMMAND | MODEL | | | | RETURN |
|---|-------|-------|---------|----------|--|
| | 331XF | 333XF | 334XF/G | 33401F/G | |
| RISE{?} { ; NL } | V | V | V | | ###.#### |
| FALL{?} { ; NL } | V | V | V | | ###.#### |
| PERD : {HIGH LOW} {?} { ; NL } | V | V | V | | ###.#### |
| LDONV {?} { ; NL } | V | V | V | V | ###.#### |
| LDOFFV {?} { ; NL } | V | V | V | V | ###.#### |
| CC CURR : {HIGH LOW} {?} { ; NL } | V | V | V | | ###.#### |
| CC CURR : {?} { ; NL } | | | | V | ###.#### |
| CP : {HIGH LOW} {?} { ; NL } | V | V | V | | ###.#### |
| CR RES : {HIGH LOW} {?} { ; NL } | V | V | V | | ###.#### |
| CR RES : {?} { ; NL } | | | | V | ###.#### |
| CV VOLT : {HIGH LOW} {?} { ; NL } | V | V | V | | ###.#### |
| CV VOLT : {?} { ; NL } | | | | V | ###.#### |
| TCONFIG {?} { ; NL } | V | V | V | V | 1:NORMAL 2:OCP 3:OPP 4:SHORT 33401F/G NO OPP |
| OCP: START {?} { ; NL } | V | V | V | V | ###.#### |

| QUERY PRESET NUMERIC COMMAND | MODEL | | | | RETURN |
|---------------------------------|-------|-------|---------|----------|-----------------|
| | 331XF | 333XF | 334XF/G | 33401F/G | |
| OCP: STEP {?}; NL} | V | V | V | V | ###.#### |
| OCP: STOP {?}; NL} | V | V | V | V | ###.#### |
| VTH {?}; NL} | V | V | V | V | ###.#### |
| OPP: START {?} ; NL} | V | V | V | | ###.#### |
| OPP: STEP {?}; NL} | V | V | V | | ###.#### |
| OPP: STOP {?}; NL} | V | V | V | | ###.#### |
| STIME {?}; NL} | V | V | V | | ###.#### |
| OCP {?} { ; NL} | V | V | V | V | ###.#### |
| OPP {?} { ; NL} | V | V | V | | ###.#### |
| VO {?} { ; NL} | | | V | V | ###.#### |
| VD {?} { ; NL} | | | V | V | ###.#### |
| RD {?} { ; NL} | | | V | V | ###.#### |
| IO {?} { ; NL} | | | V | V | ###.#### |
| RR {?} { ; NL} | | | V | | OFF or ###.#### |
| FREQ {?} { ; NL} | | | V | V | |
| DIM: LEV {?} { ; NL} | | | V | V | ##.## |
| DUTY {?} { ; NL} | | | V | V | ## |
| DIM {?} { ; NL} | | | V | V | 0 : OFF 1 : ON |
| BW {?} { ; NL} | | | V | V | 0:LO 1:HI |
| AVG {?} { ; NL} | | | V | V | |
| LEDNO {?} { ; NL} | | | V | V | |

TABLE 4-3 REMOTE CONTROL QUERY COMMAND SUMMARY

| LIMIT COMMAND | MODEL | | | | RETURN |
|-----------------------------|-------|-------|---------|----------|----------|
| | 331XF | 333XF | 334XF/G | 33401F/G | |
| IH IL{SP}{NR2}{ ; NL} | V | V | V | V | |
| IH IL {?}{ ; NL} | V | V | V | V | |
| WH WL{SP}{NR2}{ ; NL} | V | V | V | V | |
| WH WL {?}{ ; NL} | V | V | V | V | ###.#### |
| VH VL{SP}{NR2}{ ; NL} | V | V | V | V | |
| VH VL {?}{ ; NL} | V | V | V | V | ###.#### |
| SVH SVL{SP}{NR2}{ ; NL} | V | V | V | V | |
| SVH SVL {?}{ ; NL} | V | V | V | V | ###.#### |

TABLE 4-4 REMOTE CONTROL LIMIT COMMAND SUMMARY

| STAGE COMMAND | MODEL | | | | REMARK |
|---------------------------------------|-------|-------|---------|----------|---|
| | 331XF | 333XF | 334XF/G | 33401F/G | |
| LOAD {SP}{ON OFF 1 0}{ ; NL} | V | V | V | V | |
| LOAD {?}{ ; NL} | V | V | V | V | 0 : OFF 1 : ON |
| MODE {SP}{CC CR CV CP}{ ; NL} | V | V | V | | |
| MODE {SP}{CC CR CV }{ ; NL} | V | V | V | V | |
| MODE {SP}{LED}{ ; NL} | | | V | V | |
| MODE {?}{ ; NL} | V | V | V | V | 0 : CC 1 : CR 2 : CV 3 : CP 4 : LED NOTE:331XF & 333XF NO LED MODE NOTE:33401F/G NO CP MODE |
| SHOR {SP}{ON OFF 1 0}{ ; NL} | V | V | V | V | |
| SHOR {?}{ ; NL} | V | V | V | V | 0 : OFF 1 : ON |
| PRES {SP}{ON OFF 1 0}{ ; NL} | V | V | V | V | |
| PRES {?}{ ; NL} | V | V | V | V | 0 : OFF 1 : ON |
| SENS {SP}{ON AUTO 1 0}{ ; NL} | V | V | | | |
| SENSe {SP}{ON OFF}{ ; NL} | | | V | V | |
| SENS {?}{ ; NL} | V | V | V | V | 0 : OFF/AUTO 1 : ON 334XXF/G NO AUTO |
| LEV {SP}{LOW HIGH 0 1}{ ; NL} | V | V | | | |
| LEV {?}{ ; NL} | V | V | V | | 0 : LOW 1 : HIGH |

| STAGE COMMAND | MODEL | | | | REMARK |
|---------------------------------|-------|-------|---------|----------|-----------------------------|
| | 331XF | 333XF | 334XF/G | 33401F/G | |
| DYN {SP} {ON OFF 1 0} { ; NL} | V | V | V | | |
| DYN {?} { ; NL} | V | V | V | | 0 : OFF 1 : ON |
| CLR { ; NL} | V | V | V | V | |
| ERR {?} { ; NL} | V | V | V | V | |
| NG {?} { ; NL} | V | V | V | V | 0 : GO 1 : NG |
| PROT {?} { ; NL} | V | V | V | V | |
| CCR{SP}{AUTO R2}{ ; NL} | V | V | V | V | |
| NGENABLE{SP}{ON OFF}{ ; NL} | V | V | V | V | |
| POLAR{SP}{POS NEG}{ ; NL} | V | V | V | V | |
| START { ; NL} | V | V | V | V | |
| STOP { ; NL} | V | V | V | V | |
| TESTING {?} { ; NL} | V | V | V | V | 0 : TEST END 1 : TESTING |

TABLE 4-5 STAGE COMMAND SUMMARY

SYSTEM COMMAND : AVAILABLE FOR ALL MODULE.

| COMMAND | NOTE | RETURN |
|-------------------------------------|-----------------------------------|------------|
| CHAN {SP} {1 2}[A B] { ; NL} | "A B " for 333XF and 33401F/G | |
| CHAN {?} { ; NL} | "A B " for 333XF and 33401F/G | {1 2}[A B] |
| RECALL {SP} {m [,n]} { ; NL} | m=1~10 n=1~15 m:STATE , n:BANK | |
| STORE {SP} {m [,n]} { ; NL} | m=1~10 n=1~15 m:STATE , n:BANK | |
| REMOTE { ; NL} | RS232/USB/LAN command | |
| LOCAL { ; NL} | RS232/USB/LAN command | |
| NAME {?} { ; NL} | | "XXXXX" |
| *RST { ; NL} | | |
| SYNC : LOAD {SP} {ON OFF} { ; NL} | | |

TABLE 4-6 SYSTEM COMMAND SUMMARY

MEASURE COMMAND

| COMMAND | 331XF | 333XF | 334XF/G | 33401F/G | RETURN |
|-------------------------|-------|-------|---------|----------|-------------------|
| MEAS : CURR{?}{ ; NL} | V | V | V | V | ###.#### |
| MEAS : VOLT{?}{ ; NL} | V | V | V | V | ###.#### |
| MEAS : POW{?}{ ; NL} | V | V | V | V | ###.#### |
| MEAS : VC{?}{ ; NL} | V | V | V | V | ###.####,###.#### |

TABLE 4-7 MEASURE COMMAND SUMMARY

| COMMAND | 331XF | 333XF | 334XF/G | 33401F/G | RETURN |
|---|-------|-------|---------|----------|--------|
| GLOB : PRES{SP}{ON OFF}{ ; NL} | V | | V | | |
| GLOB : LOAD{SP}{ON OFF}{ ; NL} | V | V | V | V | |
| GLOB : MODE{SP}{CC CR CV CP}{ ; NL} | V | V | V | | (*9) |
| GLOB : MODE{SP}{CC CR CV CP LED}{ ; NL} | | | V | | (*9) |
| GLOB : MODE{SP}{CC CR CV LED}{ ; NL} | | | V | V | (*9) |
| GLOB : SHOR{SP}{ ON OFF}{ ; NL} | V | | V | V | (*9) |
| GLOB : DYN{SP}{ON OFF}{ ; NL} | V | V | V | | (*9) |
| GLOB : LEV{SP}{HIGH LOW}{ ; NL} | V | V | V | | (*9) |
| GLOB : RANG{SP}{1 2}{ ; NL} | V | V | V | V | (*9) |
| GLOB : MEAS : CURR{?}{ ; NL} | V | V | V | V | ###.## |
| GLOB : MEAS : VOLT{?}{ ; NL} | V | V | V | V | ###.## |

TABLE 4-8 GLOBE COMMAND SUMMARY

REMARK:

1. Frequency engineering unit: Hz
2. GLOB: GLOBAL (all channels active in same time).
3. Current engineering unit: A
4. Voltage engineering unit: V
5. Resistance engineering unit: Ω
6. Period engineering unit: ms
7. Slew-rate engineering unit: A/us or mA/us
8. Power engineering unit: W
9. *9 CR DYN function version of the following
 - a. 3305F at r2.15 version above is enabled
 - b. 3310F at r1.11 version above is enabled
 - c. 3311F at r1.11 version above is enabled.
 - d. 3312F at r1.11 version above is enabled.
 - e. 3314F at r1.11 version above is enabled.
 - f. 3315F at r1.11 version above is enabled.

MPPT CC/CR/CV TEST algorithm : Case in CC MODE, It is divided into two steps , The first step on the basis of an input conditions scanning CCstart => CCstop identify the MPP point , The second steps in accordance with MPP point perturbation (P & O) to find out the true value of MPP , At the end of P&O time, recording an MPP value, and then repeat steps 1 & 2.

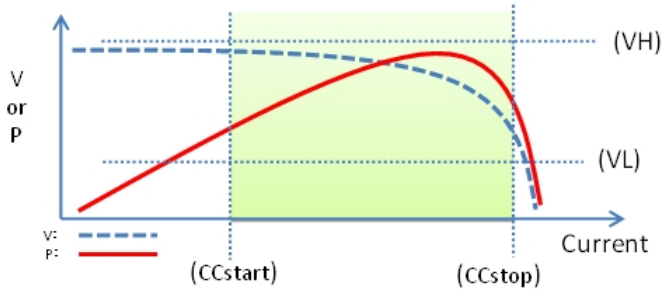

1. Enter CCstop (max value) and CCstart (minimum value)for the range where max power to be searched.
(Note: This does not search out of the range)
Next, set VH (Upper limit) and VL (Low limit).
The scan will stop when exceeded this value.
(*V limit is effective while P&O method is functioning. When exceeded this value while in P&O method, MPPT will restart.)

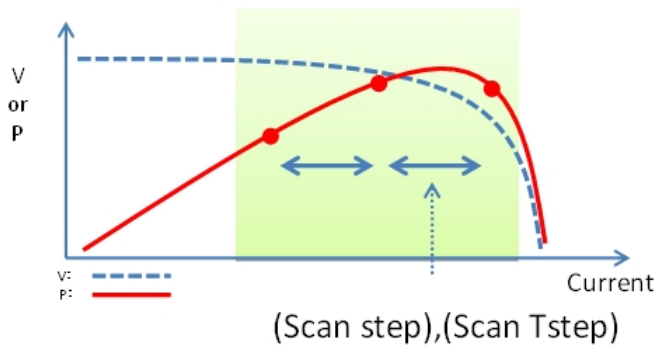

2. Enter Scan step (current step width) and Scan Tstep (step time) when searching max power)

Fig 4-2

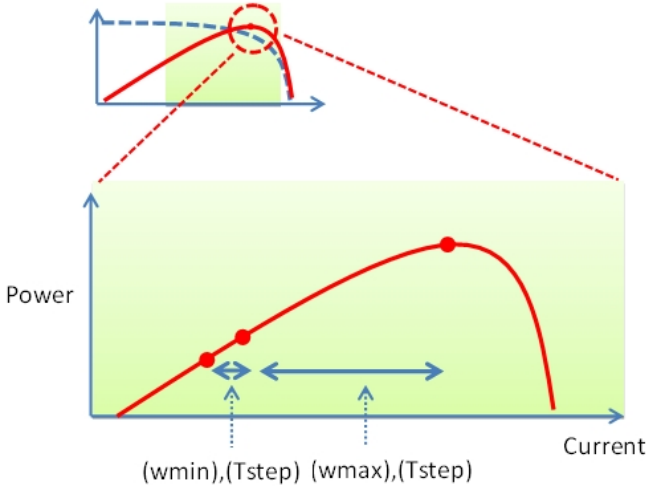

1. Set wmin (Minimum step width(of first)) and wmax (Max step width) and set PO Tstep (step time)

2. Set the step width of P&O Method)
The following two settings are made.

(1) Scount : When the load changes in one direction, and the power is increased (or decreased) , change the step width in accordance to the number of occurrence seriously.

(2) Srate (change rate) when changing the step width.

Change the step width in accordance to the (SCount) and (Srate).

Fig 4-3a

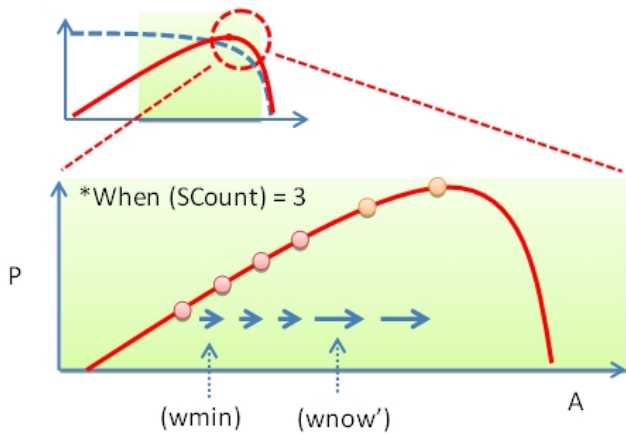

Procedure-2:: (MPPT operation by P&O Method)

After finding the starting point, it will start to increase the current at minimum step width (w_{min}) and step time (PO Tstep). As the power increased, it will increase the current.

The initial condition is seen in the follow when the present step width is given as (w_{now}):
 $(w_{now}) = (w_{min})$

When the power is increased continuously, the step width is increased in accordance to the number of continuous frequency.

The step width is increased if number of step width change frequency (Scount) and continuous frequency are met.

The increase of the load step width is changed at the specified change rate (Srate).

It is shown as follow when the step width is given in (w_{now}')

$$w_{now}' = w_{now} + w_{now} * SRate$$

This value is the present step width.

$$w_{now} = w_{now}'$$

Change width (w_{now}) increases up to maximum change width (w_{max}).

Fig 4-3b

MPPT CC/CR/CV command : 331XF at r2.08 version above is enabled

| Command | Description | Specification |
|-----------------------------|--|---|
| MPPT:MODE{SP}{CC CR CV}{NL} | Select MPPT mode (CC、CR、CV) | |
| MPPT:CC:START{SP}{NR2}{NL} | Set CC mode starting current of whole scan, unit: A | same as CC range 2 |
| MPPT:CC:STOP{SP}{NR2}{NL} | Set CC mode end current value at the end of whole scan, unit: A | same as CC range 2 |
| MPPT:CC:VL{SP}{NR2}{NL} | Set CC mode stop whole scan lower limit voltage to P&O, unit: V | same as DVM range |
| MPPT:CC:VH{SP}{NR2}{NL} | Set CC mode stop whole scan upper limit voltage to P&O, unit: V | same as DVM range |
| MPPT:CC:Wmin{SP}{NR1}{NL} | Set CC mode minimum current change width at MPPT, unit: A | same as CC range 2 |
| MPPT:CC:Wmax{SP}{NR1}{NL} | Set CC mode maximum current change width at MPPT, unit: A | same as CC range 2 |
| MPPT:CR:START{SP}{NR2}{NL} | Set CR mode starting resistance of whole scan, unit: Ω | same as CR range 1 |
| MPPT:CR:STOP{SP}{NR2}{NL} | Set CR mode end resistance value at the end of whole scan, unit: Ω | same as CR range 1 |
| MPPT:CR:VL{SP}{NR2}{NL} | Set CR mode stop whole scan lower voltage to P&O, unit: V | same as DVM range |
| MPPT:CR:VH{SP}{NR2}{NL} | Set CR mode stop whole scan upper voltage to P&O, unit: V | same as DVM range |
| MPPT:CR:Wmin{SP}{NR1}{NL} | Set CR mode minimum conductance change width at MPPT, unit: Ω | same as CR range 1 ex: 20 Ω=50mSiemens |

| | | |
|------------------------------|---|--|
| MPPT:CR:Wmax{SP}{NR1}{NL} | Set CR mode maximum conductance change width at MPPT, unit: Ω | same as CR range 1 ex: $20\Omega=50\text{mSiemens}$ |
| MPPT:CV:START{SP}{NR2}{NL} | Set CV mode starting voltage of whole scan, unit: V | same as CV range 2 |
| MPPT:CV:STOP{SP}{NR2}{NL} | Set CV mode end voltage value at the end of whole scan, unit: V | same as CV range 2 |
| MPPT:CV:IL{SP}{NR2}{NL} | Set CV mode stop whole scan lower limit current to P&O, unit: A | same as DAM range |
| MPPT:CV:IH{SP}{NR2}{NL} | Set CC mode stop whole scan upper limit current to P&O, unit: A | same as DAM range |
| MPPT:CV:Wmin{SP}{NR1}{NL} | Set CV mode minimum voltage change width at MPPT, unit: V | same as CV range 2 |
| MPPT:CV:Wmax{SP}{NR1}{NL} | Set CV mode maximum voltage change width at MPPT, unit: V | same as CV range 2 |
| MPPT:SCAN:STEP{SP}{NR1}{NL} | Set step value in whole scan, 1~2000count | 60000 or 62500 count=Full scale |
| MPPT:SCAN:Tstep{SP}{NR1}{NL} | Set time step value in whole scan, unit: ms | 10~2000ms |
| MPPT:PO:Tstep{SP}{NR1}{NL} | Set time step value in P&O, unit: ms | 10~2000ms |
| MPPT:PO:TIME{SP}{NR1}{NL} | Set P&O time, unit: sec | 10~3600000sec |
| MPPT:SRATE{SP}{NR2}{NL} | Set step width change rate | 0.01~1.00=1%~100% |
| MPPT:SCOUNT{SP}{NR1}{NL} | Set step width change judgment step no | 2~100 |
| MPPT{SP}{ON OFF}{NL} | Set MPPT start or stop test | |
| MPP?{NL} | Read MPP value, format: "V, I, P" (voltage, current, power), If electronic load echo "END" mean no new MPP value on memory | |

EXAMPLE 1: MPPT CC MODE

```

REM
MPPT:MODE CC
MPPT:CC:START 0.5
MPPT:CC:STOP 1.0
MPPT:CC:VH 13.0
MPPT:CC:VL 0.0
MPPT:CC:Wmin 0.01
MPPT:CC:Wmax 0.1
MPPT:SRATE 0.5
MPPT:SCAN:STEP 10
MPPT:SCAN:Tstep 10
MPPT:PO:Tstep 10
MPPT:PO:TIME 10
MPPT:SCOUNT 3
MPPT ON
MPP? = 12.418, 1.0010, 12.430
MPP? = 12.417, 1.0020, 12.441
MPP? = 12.418, 1.0020, 12.442
MPPT OFF
MPP? = 12.416, 1.0020, 12.440
MPP? = END

```

EXAMPLE 2: MPPT CR MODE

```
REM
MPPT:MODE CR
MPPT:CR:START 24.0
MPPT:CR:STOP 12.0
MPPT:CR:VH 13.0
MPPT:CR:VL 0.0
MPPT:CR:Wmin 3000
MPPT:CR:Wmax 60
MPPT:SRATE 0.5
MPPT:SCAN:STEP 10
MPPT:SCAN:Tstep 10
MPPT:PO:Tstep 10
MPPT:PO:TIME 10
MPPT:SCOUNT 3
MPPT ON
MPP? = 12.411, 1.0140, 12.584
MPP? = 12.326, 1.0110, 12.461
MPP? = END
MPPT OFF
```

EXAMPLE 3: MPPT CV MODE

```
REM
MPPT:MODE CV
MPPT:CV:START 8
MPPT:CV:STOP 12.2
MPPT:CV:IH 1.1
MPPT:CV:IL 0.0
MPPT:CV:Wmin 0.01
MPPT:SRATE 0.5
MPPT:SCAN:STEP 10
MPPT:SCAN:Tstep 10
MPPT:PO:Tstep 10
MPPT:PO:TIME 10
MPPT ON
MPP? = 12.201, 1.0020, 12.225
MPP? = 12.201, 1.0020, 12.225
MPP? = 12.202, 1.0020, 12.226
MPP? = 12.190, 1.0030, 12.226
MPP? = 12.201, 1.0020, 12.225
MPP? = 12.201, 1.0020, 12.225
MPP? = 12.191, 1.0030, 12.227
MPP? = END
MPPT OFF
```

AUTO SEQUENCE: Available for all modules.

| AUTO SEQUENCE COMMAND | NOTE | RETURN |
|----------------------------|-----------------------------------|---|
| FILE {SP} {n}{ ; NL} | n=1~9 | 1~9 |
| STEP {SP} {n} { ; NL} | n=1~16 | 1~16 |
| TOTSTEP {SP} {n}{ ; NL} | Total step n=1~16 | 1~16 |
| SB {SP} {m,n} { ; NL} | m=1~10 n=1~15 m:STATE , n:BANK | |
| T1 {SP} {NR2} { ; NL} | 0.1~9.9(s) | 0.1~9.9(sec) |
| T2 {SP} {NR2} { ; NL} | 0.1~9.9(s) | 0.1~9.9(sec) |
| SAVE { ; NL} | Save "File n" data | |
| REPEAT {SP} {n} { ; NL} | n=0~9999 | 0~9999 |
| RUN {SP} {F} {n} { ; NL} | n=1~9 | AUTO REPLY "PASS" or "FAIL:XX" (XX=NG STEP) |

TABLE 4-9 AUTO SEQUENCE COMMAND LIST

4.5. Computer Commands: Complex Type Format COMPLEX TYPE FORMAT

| SETTING COMMAND SUMMARY | MODEL | | | | REMARK |
|--|-------|-------|---------|----------|---|
| | 331XF | 333XF | 334XF/G | 33401F/G | |
| [PRESet :] RISE{SP} {NR2} { ; NL} | V | V | V | | A/us(3310F,11F,12F), mA/us(3314F,15F,333 XF 334XF/G) |
| [PRESet :] FALL{SP} { ; NL} | V | V | V | | A/us(3310F,11F,12F), mA/us(3314F,15F,333 XF 334XF/G) |
| [PRESet :] PERI PERD : HIGH LOW {SP} {NR2} { ; NL} | V | V | V | V | |
| [PRESet :] LDONv{SP} {NR2} { ; NL} | V | V | V | V | |
| [PRESet :] LDOFv{SP} {NR2} { ; NL} | V | V | V | V | |
| [PRESet :] CC CURR : {HIGH LOW} {SP} {NR2} { ; NL} | V | V | V | | |
| [PRESet :] CC CURR : {SP} {NR2} { ; NL} | | | | V | |
| [PRESet :] CP : {HIGH LOW} {SP} {NR2} { ; NL} | V | V | V | | |
| [PRESet :] CR RES : {HIGH LOW} {SP} {NR2} { ; NL} | V | V | V | | |
| [PRESet :] CR RES : {SP} {NR2} { ; NL} | | | | V | |
| [PRESet :] CV VOLT : {HIGH LOW} {SP} {NR2} { ; NL} | V | V | V | | |

| | | | | | |
|---|---|---|---|---|-----------------|
| [PRESet :] CV VOLT : {SP} {NR2}{; NL} | | | | V | |
| [PRESet :] TCONFIG {SP} {NORMAL OCP OPP SHORT}{; NL} | V | V | V | V | 33401F/G NO OPP |
| [PRESet :] OCP:START {SP} {NR2}{; NL} | V | V | V | V | |
| [PRESet :] OCP:STEP {SP} {NR2}{; NL} | V | V | V | V | |
| [PRESet :] OCP:STOP {SP} {NR2}{; NL} | V | V | V | V | |
| [PRESet :] VTH {SP} {NR2}{; NL} | V | V | V | V | |
| [PRESet :] OPP:START {SP} {NR2}{; NL} | V | V | V | | |
| [PRESet :] OPP:STEP {SP} {NR2}{; NL} | V | V | V | | |
| [PRESet :] OPP:STOP {SP} {NR2}{; NL} | V | V | V | | |
| [PRESet :] STIME {SP} {NR2}{; NL} | V | V | V | V | |

| SETTING COMMAND SUMMARY | MODEL | | | | REMARK |
|---|-------|-------|---------|----------|-------------------------------|
| | 331XF | 333XF | 334XF/G | 33401F/G | |
| [PRESet :] VO{SP} {NR2} { ; NL } | | | V | V | |
| [PRESet :] VD{SP} {NR2} { ; NL } | | | V | V | |
| [PRESet :] RD{SP} {NR2} { ; NL } | | | V | V | |
| [PRESet :] IO{SP} {NR2} { ; NL } | | | V | V | |
| [PRESet :] RR{SP} {OFF NR2} { ; NL } | | | V | | |
| [PRESet :] FREQ {NR1} { ; NL } | | | V | V | 10-1000=10-1000 Hz 0=DC |
| [PRESet :] DIM:LEV {NR2} | | | V | V | DIM LEVEL,0-10V |
| [PRESet :] DUTY {NR1} { ; NL } | | | V | V | 0.01-0.99=1-99% DUTY CYCLE |
| [PRESet :] BW{SP} {LO HI} { ; NL } | | | V | V | |
| [PRESet :] AVG{SP}{n}{ ; NL } | | | V | V | n=1/2/4/8/16/32/64 |
| [PRESet :] LEDNO{SP}{n}{ ; NL } | | | V | V | n=1-99 ,SET LED NUMBER |

TABLE 4-2B REMOTE CONTROL SETTING COMMAND SUMMARY

| QUERY COMMAND SUMMARY | MODEL | | | | RETURN |
|--|-------|-------|---------|----------|---|
| | 331XF | 333XF | 334XF/G | 33401F/G | |
| [PRESet :] RISE{?} { ; NL } | V | V | V | | ###.#### |
| [PRESet :] FALL{?} { ; NL } | V | V | V | | ###.#### |
| [PRESet :] PERI PERD : {HIGH LOW}{?} { ; NL } | V | V | V | | ###.#### |
| [PRESet :] LDONv {?}{ ; NL } | V | V | V | V | ###.#### |
| [PRESet :] LDOFv {?}{ ; NL } | V | V | V | V | ###.#### |
| [PRESet :] CC CURR : {HIGH LOW} {?} { ; NL } | V | V | V | | ###.#### |
| [PRESet :] CC CURR : {?} { ; NL } | | | | V | ###.#### |
| [PRESet :] CP : {HIGH LOW} {?} { ; NL } | V | V | V | | ###.#### |
| [PRESet :] CR RES : {HIGH LOW} {?} { ; NL } | V | V | V | | ###.#### |
| [PRESet :] CR RES : {?} { ; NL } | | | | V | |
| [PRESet :] CV VOLT : {HIGH LOW} {?} { ; NL } | V | V | V | | ###.#### |
| [PRESet :] CV VOLT : {?} { ; NL } | | | | V | |
| [PRESet :] TCONFIG {?}{; NL} | V | V | V | V | 1:NORMAL 2:OCP 3:OPP 4:SHORT 33401F/G NO OPP |
| [PRESet :] OCP: START {?} {; NL} | V | V | V | V | ###.#### |
| [PRESet :] OCP: STEP {?}{; NL} | V | V | V | V | ###.#### |
| [PRESet :] OCP: STOP {?}{; NL} | V | V | V | V | ###.#### |
| [PRESet :] VTH {?}{; NL} | V | V | V | V | ###.#### |
| [PRESet :] OPP: START {?} {; NL} | V | V | V | | ###.#### |
| [PRESet :] OPP: STEP {?}{; NL} | V | V | V | | ###.#### |
| [PRESet :] OPP: STOP {?}{; NL} | V | V | V | | ###.#### |
| [PRESet :] STIME {?}{; NL} | V | V | V | V | ###.#### |
| [PRESet :] VO {?}{; NL} | | | V | V | ###.#### |
| [PRESet :] VD {?}{; NL} | | | V | V | ###.#### |
| [PRESet :] RD {?}{; NL} | | | V | V | ###.#### |
| [PRESet :] IO {?}{; NL} | | | V | V | ###.#### |
| [PRESet :] RR {?}{; NL} | | | V | | OFF or ###.#### |
| [PRESet :] FREQ {?}{; NL} | | | V | V | |

| QUERY COMMAND SUMMARY | MODEL | | | | RETURN |
|---------------------------------|-------|-------|---------|----------|----------------|
| | 331XF | 333XF | 334XF/G | 33401F/G | |
| [PRESet :] DIM: LEV {?}; NL} | | | V | V | ##.## |
| [PRESet :] DUTY {?}; NL} | | | V | V | ## |
| [PRESet :] DIM {?}; NL} | | | V | V | 0 : OFF 1 : ON |
| [PRESet :] BW {?} { ; NL} | | | V | V | 0:LO 1:HI |
| [PRESet :] AVG {?} { ; NL} | | | V | V | |
| [PRESet :] LEDNO {?} { ; NL} | | | V | V | |

TABLE 4-3B REMOTE CONTROL QUERY COMMAND SUMMARY

| LIMIT COMMAND | MODEL | | | | RETURN |
|--|-------|-------|---------|----------|----------|
| | 331XF | 333XF | 334XF/G | 33401F/G | |
| LIMit : CURRent : {HIGH LOW}{SP}{NR2}{ ; NL} | V | V | V | V | |
| LIMit : CURRent : {HIGH LOW }{?}{ ; NL} | V | V | V | V | ###.#### |
| IH IL{SP}{NR2}{ ; NL} | V | V | V | V | |
| IH IL {?}{ ; NL} | V | V | V | V | |
| LIMit : POWer : {HIGH LOW}{SP}{NR2}{ ; NL} | V | V | V | V | |
| LIMit : POWer : {HIGH LOW }{?}{ ; NL} | V | V | V | V | ###.#### |
| WH WL{SP}{NR2}{ ; NL} | V | V | V | V | |
| WH WL {?}{ ; NL} | V | V | V | V | ###.#### |
| LIMit : VOLTage : {HIGH LOW}{SP}{NR2}{ ; NL} | V | V | V | V | |
| LIMit : VOLTage : {HIGH LOW }{?}{ ; NL} | V | V | V | V | ###.#### |
| VH VL{SP}{NR2}{ ; NL} | V | V | V | V | |
| VH VL {?}{ ; NL} | V | V | V | V | ###.#### |
| SVH SVL{SP}{NR2}{ ; NL} | V | V | V | V | |
| SVH SVL {?}{ ; NL} | V | V | V | V | ###.#### |

TABLE 4-4B REMOTE CONTROL LIMIT COMMAND SUMMARY

| STAGE COMMAND | MODEL | | | | REMARK |
|---|-------|-------|---------|----------|--|
| | 331XF | 333XF | 334XF/G | 33401F/G | |
| [STaTe :] LOAD {SP}{ON OFF} { ; NL} | V | V | V | V | |
| [STaTe :] LOAD {?} { ; NL} | V | V | V | V | 0 : OFF 1 : ON |
| [STaTe :] MODE {SP} {CC CR CV CP} { ; NL} | V | V | V | | |
| [STaTe :] MODE {SP} {CC CR CV } { ; NL} | V | V | V | V | |
| [STaTe :] MODE {LED} { ; NL} | | | V | V | |
| [STaTe :] MODE {?} { ; NL} | V | V | V | V | 0:CC 1:CR 2: CV 3:CP 4:LED 331XF & 333XF no LED Mode 33401F/G no CP Mode |
| [STaTe :] SHORt {SP} {ON OFF} { ; NL} | V | V | V | V | |
| [STaTe :] SHORt {?} { ; NL} | V | V | V | V | 0 : OFF 1 : ON |
| [STaTe :] PRESet {SP} {ON OFF} { ; NL} | V | V | V | V | |
| [STaTe :] PRESet {?} { ; NL} | V | V | V | V | 0 : OFF 1 : ON |
| [STaTe :] SENSE {SP} {ON AUTO} { ; NL} | V | V | | | |
| [STaTe :] SENSE {SP} {ON OFF} { ; NL} | | | V | V | |
| [STaTe :] SENSE {?} { ; NL} | V | V | V | V | 0 : OFF/AUTO 1 : ON 334XXF/G Not AUTO |
| [STaTe :] LEVEl {SP} { LOW HIGH} { ; NL} | V | V | V | | |
| [STaTe :] LEVEl {?} { ; NL} | V | V | V | | 0 : LOW 1 : HIGH |
| [STaTe :] DYNAmic {SP} {ON OFF} { ; NL} | V | V | V | | |
| [STaTe :] DYNAmic {?} { ; NL} | V | V | V | | 0 : OFF 1 : ON |
| [STaTe :] CLR{ ; NL} | V | V | V | V | |
| [STaTe :] ERRor {?} { ; NL} | V | V | V | V | |
| [STaTe :] NG {?} { ; NL} | V | V | V | V | 0 : GO 1 : NG |
| [STaTe :] PROTEct {?} { ; NL} | V | V | V | V | |
| [STaTe :] CCR{SP}{AUTO R2}{ ; NL} (NOTE 1) | V | V | V | V | |
| [STaTe :] NGENABLE{SP}{ON OFF}{ ; NL} | V | V | V | V | |

| STAGE COMMAND | MODEL | | | | REMARK |
|---|-------|-------|---------|----------|-------------------------------|
| | 331XF | 333XF | 334XF/G | 33401F/G | |
| [STaTe :]POLAR{SP}{POS NEG}{ ; NL} | V | V | V | V | |
| [STaTe :]START{ ; NL} | V | V | V | V | |
| [STaTe :]STOP{ ; NL} | V | V | V | V | |
| [STaTe :]TESTING {?}{ ; NL} | V | V | V | V | 0 : TEST END , 1 : TESTING |

TABLE 4-5B STAGE COMMAND SUMMARY

SYSTEM COMMAND: available for all module

| COMMAND | NOTE | RETURN |
|---|--------------------------------|----------------|
| [SYStem :] CHANnel {SP} {1 2}[A B] { ; NL} | A B “ for 333XF and 33401F/G | |
| [SYStem :] CHANnel {?}{ ; NL} | A B “ for 333XF and 33401F/G | {1 2}[A B] |
| [SYStem :] RECall {SP} {m [,n] } { ; NL} | m=1~10 n=1~15 | |
| [SYStem :] STORe {SP} {m [,n] } { ; NL} | m=1~10 n=1~15 | |
| [SYStem :] REMOTE { ; NL} | RS232/USB/LAN command | |
| [SYStem :] LOCAL{ ; NL} | RS232/USB/LAN command | |
| [SYStem :] NAME {?} { ; NL} | | “XXXXX” |
| [SYStem :] *RST { ; NL} | | |
| SYNC : LOAD {SP} {ON OFF} { ; NL} | | |

TABLE 4-6B SYSTEM COMMAND SUMMARY

MEASURE COMMAND: AVAILABLE FOR ALL MODULE

| COMMAND | 331XF | 333XF | 334XF/G | 33401F/G | RETURN |
|-------------------------------|-------|-------|---------|----------|-------------------|
| MEASure : CURRent{?}{ ; NL} | V | V | V | V | ###.#### |
| MEASure : VOLTage{?}{ ; NL} | V | V | V | V | ###.#### |
| MEASure : POW{?}{ ; NL} | V | V | V | V | ###.#### |
| MEAS : VC{?}{ ; NL} | V | V | V | V | ###.####,###.#### |

TABLE 4-7B MEASURE COMMAND SUMMARY

| COMMAND | 331XF | 333XF | 334XF/G | 33401F/G | NOTE |
|--|-------|-------|---------|----------|------|
| GLOBE : [STaTe :] PRESet{SP}{ON OFF}{ ; NL} | V | | V | | |
| GLOBE : [STaTe :] LOAD{SP}{ON OFF}{ ; NL} | V | V | V | V | |
| GLOBE : [STaTe :] MODE {SP}{CC CR CV CP}{ ; NL} | V | V | V | | *9 |
| GLOBE : [STaTe :] MODE {SP}{CC CR CV}{ ; NL} | V | V | V | V | |
| GLOBE : [STaTe :] MODE {SP}{LED } { ; NL} | | | V | V | *9 |
| GLOBE : [STaTe :] SHORt{SP}{ ON OFF}{ ; NL} | V | | V | | *9 |
| GLOBE : [STaTe :] DYNAmic{SP}{ON OFF}{ ; NL} | V | V | V | | *9 |
| GLOBE : [STaTe :] LEVe{SP}{HIGH LOW}{ ; NL} | V | V | V | | *9 |
| GLOBE : MEASure : CURRent{?}{ ; NL} | V | V | V | V | |
| GLOBE : MEASure : VOLTage{?}{ ; NL} | V | V | V | V | |

TABLE 4-8B GLOBE COMMAND SUMMARY

REMARK:

1. Frequency engineering unit: Hz
2. GLOB: GLOBAL (all channels active in same time) .
3. Current engineering unit: A
4. Voltage engineering unit: V
5. Resistance engineering unit: Ω
6. Period engineering unit: ms
7. Slew-rate engineering unit: A/us or mA/us
8. Power engineering unit: W
9. *9 CR DYN function version of the following
 - a. 3305F at r2.15 version above is enabled.
 - b. 3310F at r1.11 version above is enabled.
 - c. 3311F at r1.11 version above is enabled.
 - d. 3312F at r1.11 version above is enabled.
 - e. 3314F at r1.11 version above is enabled.
 - f. 3315F at r1.11 version above is enabled.

AUTO SEQUENCE: AVAILABLE FOR ALL MODULES

| AUTO SEQUENCE COMMAND | NOTE | RETURN |
|---------------------------|-----------------------------------|---|
| FILE {SP} {n}{ ; NL} | n=1~9 | 1~9 |
| STEP {SP} {n}{ ; NL} | n=1~16 | 1~16 |
| TOTSTEP {SP} {n}{ ; NL} | Total step n=1~16 | 1~16 |
| SB {SP} {m,n}{ ; NL} | m=1~10 n=1~15 m:STATE , n:BANK | |
| T1 {SP} {NR2}{ ; NL} | 0.1~9.9(s) | 0.1~9.9(sec) |
| T2 {SP} {NR2}{ ; NL} | 0.1~9.9(s) | 0.1~9.9(sec) |
| SAVE { ; NL} | Save "File n" data | |
| REPEAT {SP} {n}{ ; NL} | n=0~9999 | 0~9999 |
| RUN {SP} {F} {n}{ ; NL} | n=1~9 | AUTO REPLY "PASS" or "FAIL:XX" (XX=NG STEP) |

TABLE 4-9B AUTO SEQUENCE COMMAND LIST

4.6. Remote Control Command Descriptions

- 4.6.1. **SETTING functions are used to program sink values along with the operating Mode.** The user can also preset dynamic waveforms and set up OCP, OPP, OVP & SHORT tests. The special parameters used for the 3340F/G series of LED Simulators are also described in this section.

RISE

Command Syntax:

```
[ PRESet : ] RISE {SP}{NR2}{ ; |NL}
```

```
[ PRESet : ] RISE ? { ; |NL}
```

Purpose: Set and read the RISE SLEW-RATE

Description:

1. The definition of the RISE SLEW-RATE is the rate of current change from a LOW level to a HIGH level when operating in dynamic mode. The settings of RISE and FALL are completely independent.
2. The RISE command must include a number value otherwise the command will not be valid.
3. The least significant number is the 4th digit after the decimal point.
4. Should a value be entered that is higher than what is possible then the 3305F will automatically set its maximum value according the load module fitted.
5. The engineering unit is A/us for load modules 3310F, 3311F & 3312F.
The engineering unit is mA/us for load modules 3314F, 3315F, 333XF & 3340F/G

FALL

Command Syntax:

```
[ PRESet : ] FALL {SP}{ ; |NL}
```

```
[ PRESet : ] FALL? { ; |NL}
```

Purpose: Set and read the FALL SLEW-RATE

Description:

1. The definition of the FALL SLEW-RATE is the rate of current change from a HIGH level to a LOW level when operating in dynamic mode. The settings of RISE and FALL are completely independent.
2. Should a value be entered that is higher than what is possible then the 3305F will automatically set its maximum value according the load module fitted.
3. The engineering unit is A/us for load modules 3310F, 3311F & 3312F.
The engineering unit is mA/us for load modules 3314F, 3315F, & 333XF

PERI or PERD**Command Syntax:**

```
[ PRESet : ] PERI | PERD : HIGH | LOW {SP} {NR2} { ; | NL }
```

```
[ PRESet : ] PERI | PERD : HIGH | LOW ? { ; | NL }
```

Purpose: Set and read the combined TLOW and THIGH of a DYNAMIC waveform

Description:

1. The time period combines TLOW (time low) and THIGH (time high) sections of a DYNAMIC waveform.
2. The value of TLOW and THIGH has to be included the number of the decimal point; otherwise the command will not be available.
3. The least significant number is the 5th after the decimal point.
4. Should a value be entered that is higher than what is possible then the 3305F will automatically set its maximum value according the load module fitted
5. The engineering unit is ms.

LDONv**Command Syntax:**

```
[ PRESet : ] LDONv {SP} {NR2} { ; | NL }
```

```
[ PRESet : ] LDONv ? { ; | NL }
```

Purpose: Set and Read the voltage level which the LOAD will switch ON

Description: This command is for setting the voltage value at which the LOAD Will automatically switch ON. The engineering unit is V.

LDOFv**Command Syntax:**

```
[ PRESet : ] LDOFv {SP} {NR2} { ; | NL }
```

```
[ PRESet : ] LDOFv ? { ; | NL }
```

Purpose: Set and Read the voltage level which the LOAD will switch OFF

Description: This command is for setting the voltage value at which the LOAD will automatically switch OFF. The engineering unit is V.

CURR : HIGH | LOW**Command Syntax:**

```
[ PRESet : ] CC | CURR : HIGH | LOW {SP} {NR2} { ; | NL }
```

```
[ PRESet : ] CC | CURR : HIGH | LOW ? { ; | NL }
```

Purpose: Set and read the HIGH | LOW current levels.

Description: This command is used for setting the HIGH and LOW levels of Load current. These 2 current levels need to be used should a dynamic load Waveform is desired. It also allow the user to switch between 2 preset current Levels.

1. The least significant number is the 5th digit after the decimal point.
2. The LOW level current value cannot be higher than the HIGH level.
3. Should a value be entered that is higher than what is possible then the 3305F will automatically set its maximum value according the load module fitted.
4. The engineering unit is A.

CURR**Command Syntax:**

```
[ PRESet : ] CC | CURR { SP } { NR2 } { ; | NL }
```

```
[ PRESet : ] CC | CURR ? { ; | NL }
```

Purpose: Set and read the current.

Description: This command is used for setting of load current.

1. The least significant number is the 5th digit after the decimal point.
2. Should a value be entered that is higher than what is possible then the 3305F will automatically set its maximum value according the load module fitted.
3. The engineering unit is A.

CP : { HIGH | LOW }**Command Syntax:**

```
[ PRESet : ] CP : { HIGH | LOW } { SP } { NR2 } { ; | NL }
```

```
[ PRESet : ] CP : { HIGH | LOW } ? { ; | NL }
```

Purpose: Set and read the operating power value in Watts

Description: This command is used for setting the HIGH and LOW setting Levels of load power. These 2 power levels need to be used should a dynamic Load waveform be desired. It also allow the user to switch between 2 preset power levels.

1. The least significant number is the 5th digit after the decimal point.
2. The LOW level power value cannot be higher than the HIGH level.
3. Should a value be entered that is higher than what is possible then The 3305F will automatically set its maximum value according the load module fitted.
4. The engineering unit is W.

CR | RES : { HIGH | LOW }**Command Syntax:**

```
[ PRESet : ] CR | RES : { HIGH | LOW } { SP } { NR2 } { ; | NL }
```

```
[ PRESet : ] CR | RES : { HIGH | LOW } ? { ; | NL }
```

Purpose: Set and read the HIGH | LOW resistance levels.

Description: This command is used for setting the HIGH and LOW levels of Load resistance. It allows the user to switch between 2 resistance levels.

1. The least significant number is the 5th digit after the decimal point.
2. The LOW level resistance value cannot be higher than the HIGH level.
3. Should a value be entered that is higher than what is possible then The 3305F will automatically set its maximum value according the load module fitted.
4. The engineering unit is Ω .

CR|RES**Command Syntax:**

```
[ PRESet : ] CR|RES{SP}{ NR2}{ ; |NL}
```

```
[ PRESet : ] CR|RES ? { ; |NL}
```

Purpose: Set and read the resistance.

Description: This command is used for setting of load resistance.

1. The least significant number is the 5th digit after the decimal point.
2. Should a value be entered that is higher than what is possible then The 3305F will automatically set its maximum value according the load module fitted.
3. The engineering unit is Ω .

CV : {HIGH|LOW}**Command Syntax:**

```
[ PRESet : ] CV : { HIGH|LOW}{SP}{ NR2}{ ; |NL}
```

```
[ PRESet : ] CV : { HIGH|LOW}? { ; |NL}
```

Purpose: Set and Read the value of AC Load Voltage

Description: This command is used for setting the HIGH and LOW levels of Load voltage. It allows the user to switch between 2 voltage levels.

1. The least significant number is the 5th digit after the decimal point.
2. The LOW level resistance value cannot be below the HIGH level.
3. Should a value be entered that is higher than what is possible then The 3305F will automatically set its maximum value according the load Module fitted.
4. The engineering unit is V.

CV**Command Syntax:**

```
[ PRESet : ] CV{SP}{ NR2}{ ; |NL}
```

```
[ PRESet : ] CV ? { ; |NL}
```

Purpose: Set and Read the value of DC Load Voltage

Description: This command is used for setting the of load voltage.

1. The least significant number is the 5th digit after the decimal point.
2. Should a value be entered that is higher than what is possible then The 3305F will automatically set its maximum value according the load Module fitted.
3. The engineering unit is V.

OCP: START**Command Syntax:**

```
[PRESet : ] OCP:START {SP}{NR2}{ ; |NL}
```

```
[PRESet : ] OCP:START ? { ; |NL}
```

Purpose: Set and read the initial value of OCP test

Description: This command is used for setting the required initial value (I-START) of OCP test.

OCp: STEP**Command Syntax:**

```
[PRESet : ] OCP:STEP {SP}{NR2}{ ; |NL}
```

```
[PRESet : ] OCP:STEP ? { ; |NL}
```

Purpose: Set and read the increasing value of OCP Test

Description: This command is used for setting the increasing value (I-STEP) of OCP Test.

OCp: STOP**Command Syntax:**

```
[PRESet : ] OCP:STOP {SP}{NR2}{ ; |NL}
```

```
[PRESet : ] OCP: STOP? { ; |NL}
```

Purpose: Set and read the maximum value of OCP Test

Description: This command is used for setting the maximum value (I-STOP) of OCP Test.

VTH**Command Syntax:**

```
[PRESet : ] VTH {SP}{NR2}{ ; |NL}
```

```
[PRESet : ] VTH ? { ; |NL}
```

Purpose: Set and read the value of the Threshold Voltage

Description: This command is used for setting a minimum Threshold Voltage for the OCP/OPP tests. If the measured voltage is below the threshold voltage And the OCP/OPP test started the test will not run and an error will be Flagged.

OPP: START**Command Syntax:**

```
[PRESet : ] OPP:START {SP}{NR2}{ ; |NL}
```

```
[PRESet : ] OPP:START ? { ; |NL}
```

Purpose: Set and read the initial value of OPP Test

Description: This command is used for setting the initial value (P-START) of the OPP Test.

OPP: STEP**Command Syntax:**

```
[PRESet : ] OPP:STEP {SP}{NR2}{ ; |NL}
```

```
[PRESet : ] OPP:STEP ? { ; |NL}
```

Purpose: Set and read the increasing value of OPP Test

Description: This command is used for setting the power increments which the OPP test will follow between the P-START and P-STOP values.

OPP: STOP**Command Syntax:**

```
[PRESet : ] OPP:STOP {SP}{NR2}{ ; |NL}
```

```
[PRESet : ] OPP:STOP ? { ; |NL}
```

Purpose: Set and read the maximum value of OPP Test

Description: This command is used to set the maximum power value (P-STOP) of The OPP test.

TCONFIG**Command Syntax:**

```
[PRESet : ] TONFIG {NORMAL|OCP|OVP|OPP|SHORT}{ ; |NL}
```

```
[PRESet : ] TONFIG ? { ; |NL}
```

Purpose: Set and read the function of Dynamic Test

Description: There are four options of this command. Those are NORMAL mode, OCP Test, OVP Test, OPP Test and SHORT Mode Test.

STIME**Command Syntax:**

```
[PRESet : ] STIME {SP}{NR2}{ ; |NL}
```

```
[PRESet : ] STIME ? { ; |NL}
```

Purpose: Set and read time of the short-circuit test

Description: This command is used for setting the short-circuit test time. If the time is set to 0 then there is no time limit. In other words a continuous short circuit test will be implemented. If a number is entered then this is the Test time in milliseconds (ms).

OCP**Command Syntax:**

```
OCP?
```

Purpose: read OCP testing current.

Description: This command is used for reading the OCP current measured in the OCP test.

OPP**Command Syntax:**

```
OPP?
```

Purpose: read OPP testing watt.

Description: This command is used for reading the OPP power for the OPP test.

MPPT**Command Syntax:**

```
[PRESet : ] MPPT {SP} ON|OFF{ ; |NL}
```

Purpose: MPPT (maximum power point tracking) test ON/OFF

Description:

This command is set MPPT test ON / OFF.

MPP**Command Syntax:**

```
[PRESet : ] MPP? { ; |NL}
```

Purpose: read MPP (maximum power point) data, Read form: Voltmeter/Ammeter/Power Meter.

Description:

MPP read form: Voltmeter / Ammeter/ Power Meter.

BW**Command Syntax:**

```
[PRESet : ]BW{SP} {LO | HI} { ; | NL}
```

```
[PRESet : ] BW{?}
```

Purpose: Set and read the BW level to LO or HI.

Description: The BW command allows the user to changes the bandwidth of the 33401F/G / 3340F/G series load when operating in LED mode. The BW Function can be Used when in CC Mode, CV Mode and CR Mode Range I. The initial Value of the bandwidth is HI.

Please note that when operating in CR Mode Range II there is only one bandwidth,

AVG**Command Syntax**

```
[PRESet : ] AVG{SP}{n}
```

```
[PRESet : ] AVG{?}
```

Purpose: set and read VI Measuring Average

Description: A number of voltage and current measurements can be taken and their Values averaged. The average function can be set in the range of 1 to 64. The default value is 1.

LEDNO**Command Syntax**

```
[PRESet : ] LEDNO{SP}{n}
```

```
[PRESet : ] LEDNO {?}
```

Purpose: Set and read quantity of LEDs to be simulated

Description: This command allows the user to enter the total number of LEDs the 33401F/G / 3340F/G series is to simulate.

- For models 3340F/G and 3342F/G the LEDNO setting range is 1 to 90
- For the 3341F/G model the LEDNO setting range is 1 to 30
- For the 33401F/G model the LEDNO setting range is 1 to 90

VO**Command Syntax**

```
[PRESet : ]VO{SP} {NR2} { ; | NL}
```

```
[PRESet : ]VO {?}{;|NL}
```

Purpose: Set and read Vo Voltage in LED mode.

Description: This command is used to set and read back the output voltage VO for The 3340F/G series of LED simulators. The engineering unit is V

VD**Command Syntax**

```
[PRESet : ]VD{SP} {NR2} { ; | NL}
```

```
[PRESet : ] VD {?}{;|NL}
```

Purpose: Set and read Vd Voltage in LED mode.

Description: This command is used to set and read back the forward bias voltage (Vd) Of the 3340F/G units when operating in LED mode. The engineering unit is V.

RD**Command Syntax**

```
[PRESet : ] RD{SP} {NR2} { ; | NL}
```

```
[PRESet : ] RD {?};|NL}
```

Purpose: Set and read RD Impedance in LED mode.

Description: This command is used to set and read the Impedance (Rd) value
When the 33401F/G and 3340F/G units are operated in LED mode. The engineering unit is Ω .

IO**Command Syntax**

```
[PRESet : ] IO{SP} {NR2} { ; | NL}
```

```
[PRESet : ] IO {?};|NL}
```

Purpose: Set and read IO current in LED mode.

Description: This command is used to set and read the LED current (IO) value
When the 33401F/G and 3340F/G units are operated in LED mode. The engineering unit is A.

RR**Command Syntax**

```
[PRESet : ] RR{SP} {OFF | NR2} { ; | NL}
```

```
[PRESet : ] RR {?};|NL}
```

Purpose: Set and read Rr Impedance in LED mode.

Description: This command is used to set the Rr Impedance of 3340F/G when it is
Used to simulate LEDs. The Rr is used to simulate the high frequency
Impedance and high frequency ripple of an LED string. The engineering
Unit is Ω .

DIM LEV**Command Syntax**

```
[PRESet : ] DIM:LEV {NR2}
```

```
[PRESet : ] DIM: LEV {?};|NL}
```

Purpose: Set and read dimming control level.

Description: This command is used to set the dimming control level for the
33401F/G and 3340F/G series when used to simulate LEDs. The
dimming Range is 0-10V. The Engineering unit is V.

FREQ**Command Syntax**

```
[PRESet : ] FREQ {NR1} ; { ; | NL}
```

```
[PRESet : ] FREQ {?};|NL}
```

Purpose: Set and read FREQ.

Description: This command is necessary to set the frequency rate of the dimming
Control. A range of 10Hz to 1000Hz is possible. The engineering unit is
Hz.

DIM**Command Syntax**

```
[PRESet : ] DIM {OFF|ON}
```

```
[PRESet : ] DIM {?};|NL}
```

Purpose: This command is set and read dim ON/OFF.

Description: This command is required to turn the dimming control function ON/OFF.

0 = off and 1 = ON.

DUTY

Command Syntax

[PRESet :] DUTY {NR1}

[PRESet :] DUTY {?};|NL}

Purpose: Set and read DUTY cycle.

Description: This command is for setting the duty cycle when the 33401F/G and 3340F/G Series is used in LED mode. If the FREQ is set to DC then a duty cycle Command will not be valid the setting range for the duty cycle is 0.01 to 0.99. This corresponds to a duty cycle of 1% to 99% as illustrated below.

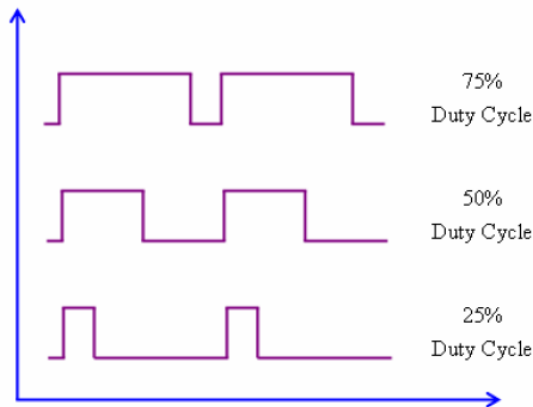

- 4.6.2. LIMIT functions can be used to set higher and lower operating limits that can be Used in conjunction with the NG function to signal that the load is sinking outside The expected parameters.

[LIMit :]CURRent : {HIGH | LOW} or IH | IL

Command Syntax:

[LIMit] : CURRent : { HIGH | LOW}{SP}{ NR2 }{ ; | NL}

[LIMit] : CURRent : { HIGH | LOW} ? { ; | NL}

[IH | IL]{SP}{ NR2 }{ ; | NL}

[IH | IL]?{ ; | NL}

Purpose: Set & read the HIGH / LOW load current limits when operating in CC or CR modes.

Description: This command is used to set 2 current LIMIT values. Operation Outside these LIMIT values will cause a NG signal.

1. The LOW level cannot be higher than the HIGH level.
2. If the current taken by the load falls below the LOW limit then a No Good (NG) signal is available
3. If the current rises above the HIGH limit then the NG signal is available
4. If the current stays between HIGH and LOW LIMIT levels the NG Signal will not be sent.

[LIMit :]POWER : {HIGH | LOW} or WH | WL

Command Syntax:

[LIMit] : POWER : { HIGH | LOW}{SP}{ NR2 }{ ; | NL}

[LIMit] : POWER : { HIGH | LOW} ? { ; | NL}

[WH | WL]{SP}{ NR2 }{ ; | NL}

[WH|WL]?{ ; |NL}

Purpose: Set & read the HIGH / LOW load power limits when operating in CP or CR modes.

Description: This command is used to set 2 power LIMIT values. Operation Outside these LIMIT values will cause a NG signal.

1. The LOW level cannot be higher than the HIGH level.
2. If the power taken by the load falls below the LOW limit then a No Good (NG) signal is available
3. If the power rises above the HIGH limit then the NG signal is available
4. If the power stays between HIGH and LOW LIMIT levels the NG Signal will not be sent.

[LIMit :] VOLTage : {HIGH | LOW} or VH | VL

Command Syntax:

[LIMit] VOLTage : { HIGH | LOW}{SP}{ NR2 }{ ; |NL}

[LIMit] VOLTage : { HIGH | LOW} ? { ; |NL}

[VH | VL]{SP}{ NR2 }{ ; |NL}

[VH | VL]?{ ; |NL}

Purpose: Set & read the HIGH / LOW limits of voltage present at the load terminals.

Description: This command is used to set 2 voltage LIMIT values. Operation Outside these LIMIT values will cause a NG signal.

1. The LOW level cannot be higher than the HIGH level.
2. If the voltage at the load input falls below the LOW limit then a No Good (NG) signal is available
3. If the voltage rises above the HIGH limit then the NG signal is Available.
4. If the current stays between HIGH and LOW LIMIT levels the NG Signal will not be sent.

[LIMit :] SVH | SVL

Command Syntax:

[LIMit :] {SVH | SVL}{SP}{ NR2 }{ ; |NL}

[LIMit :] {SVH | SVL}?{ ; |NL}

Purpose: Set & read the upper and lower voltage levels during for short test.

Description: This command is used to set 2 voltage LIMIT values. If during the Short test the voltage is outside these LIMIT values a NG signal will be Given.

1. The LOW level cannot be higher than the HIGH level.
2. If the voltage at the load input falls below the LOW limit then a No Good (NG) signal is available
3. If the voltage rises above the HIGH limit then the NG signal is given.
4. If the current stays between HIGH and LOW LIMIT levels the NG signal Will not be sent.

- 4.6.3. STATE functions can be used to see the actual operating status of the electronic Load at that time.

[STATE :] LOAD {SP}{ON | OFF}

Command Syntax:

[STATE :] LOAD{SP}{ON | OFF}{ ; | NL}

[STATE :] LOAD ? { ; | NL}

Purpose: Read LOAD ON/OFF status

Description: This command is used to see if the Load is ON or OFF

0 = Load OFF

1 = Load ON

[STATE :] MODE {SP}{CC | CR | CV | CP | LED}

Command Syntax:

[STATE :] MODE {SP}{CC | CR | CV | CP | LED}{ ; | NL}

[STATE :] MODE ? { ; | NL}

Purpose: Set and read the operating mode of LOAD

Description: The return value is 0 | 1 | 2 | 3 | 4 which corresponds to the operating mode that the load is in. i.e. CC | CR | CV | CP | LED

| Mode (value) | CC (0) | CR (1) | CV (2) | CP (3) | LED (4) |
|-----------------|-----------|-----------|-----------|-----------|------------|
| 331XF | V | V | V | V | |
| 333XF | V | V | V | V | |
| 334XF/G | V | V | V | V | V |
| 33401F/G | V | V | V | | V |

TABLE 4-10 MODULES FOR EACH SERIES

[STATE :] SHORT {SP}{ON | OFF}

Command Syntax:

[STATE :] SHORT {SP}{ON | OFF}{ ; | NL}

[STATE :] SHORT ? { ; | NL}

Purpose: Reads back whether the short circuit test is active or not

Description: 0 = short circuit test active

1 = short circuit test inactive

[STATE :] PRESet {SP}{ON | OFF}

Command Syntax:

[STATE :] PRESet {SP}{ON | OFF} ; |NL}

[STATE :] PRESet ? { ; |NL}

Purpose: Reads back whether load is in preset mode.

Description: This command is used to check if the load is in preset mode.

0 = Preset mode OFF

1 = Preset mode ON

[STATE :] SENSE{SP}{ON | OFF | AUTO}

Command Syntax:

[STATE :] SENSE{SP}{ON | OFF | AUTO} ; |NL}

[STATE :] SENSE ? { ; |NL}

Purpose: Reads back whether the sense function is ON or OFF

Description: 0 = Sense OFF or Sense AUTO

1 = Sense ON

[STATE :] LEVel {SP}{HIGH | LOW} or LEV {SP}{HIGH | LOW}

Command Syntax:

[STATE :] LEVel {SP}{HIGH | LOW} ; |NL}

[STATE :] LEVel ? { ; |NL}

[STATE :] LEV{SP}{HIGH | LOW} ; |NL}

[STATE :] LEV? { ; |NL}

Purpose: Reads back whether the load is operating at its LOW or HIGH LEVEL

Description: In CC, CR, CV or CP operating modes the user can set 2 LEVELS of Load current, resistance, voltage or power. The load will read back which level it is At:

0 = Load operating at low level

1 = Load operating at high level

[STATE :] DYNamic{SP}{ON | OFF}

Command Syntax:

[STATE :] DYNamic{SP}{ON | OFF} ; |NL}

[STATE :] DYNamic ? { ; |NL}

Purpose: Reads back whether the load is operating in STATIC or DYNAMIC mode

Description: 0 = Dynamic operation

1 = Static Operation

[STATE :] CLR

Command Syntax:

[STATE :] CLR { ; |NL}

Purpose: Clears the error flag

Description: This command is used for clearing the contents of the PROT and ERR registers. After execution, the contents of these two registers will be "0".

[STATE :] ERRor**Command Syntax:**

[STATE :] ERRor ?{ ; |NL}

Purpose: Query if there are any errors flagged in the module.**Description:**

1. ERR? : Read the register of ERR status. TABLE 4-11 shows the Corresponding number of ERR status
2. Use command CLR to clear the register of ERR status to be "0"

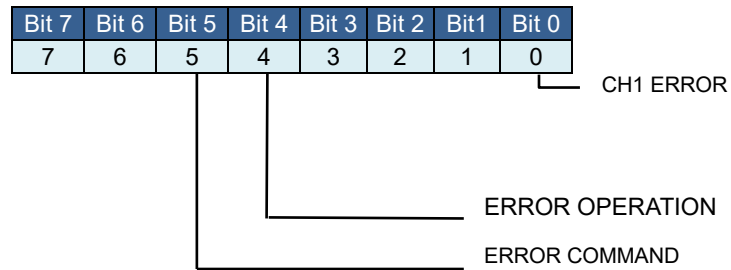

| BIT ID | BIT VALUE | REMARK |
|---------|------------------------|-----------------------------------|
| bit 0~3 | 0 = Off, 1 = Triggered | CH1 error |
| bit 4 | 0 = Off, 1 = Triggered | Operation error |
| bit 5 | 0 = Off, 1 = Triggered | Command error (e.g. syntax error) |

TABLE 4-11 ERROR register

[STATE :] NG ?**Command Syntax:**

[STATE :] NG?{ ; |NL}

Purpose: Query if the NG flag is displayed on this module

Description: Set command NG ? to show the NG status. If the response is "0" the LED of NG (NO GOOD) will be off. If the response is "1" the LED will be lit, showing that the NG flag is present.

[STATe :] PROTeCt ?

Command Syntax:

[STATe :] PROTeCt?{ ; | NL}

Purpose: Query the state of the protection register on this module

Description: 1. PROT? requests the status of the units protection register.
2. Use the command "CLR" to clear the register of PROT status to "0"

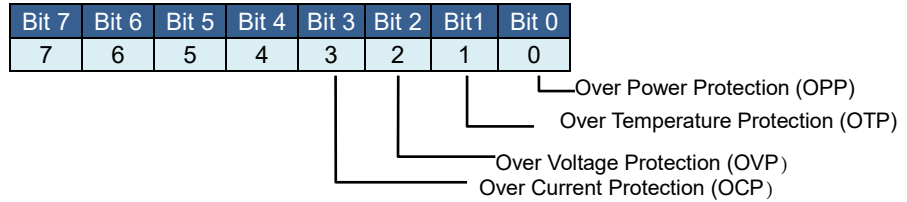

| BIT ID | BIT VALUE | REMARK |
|--------|------------------------|-----------------------------------|
| bit 0 | 0 = Off, 1 = Triggered | Over Power Protection (OPP) |
| bit 1 | 0 = Off, 1 = Triggered | Over Temperature Protection (OTP) |
| bit 2 | 0 = Off, 1 = Triggered | Over Voltage Protection (OVP) |
| bit 3 | 0 = Off, 1 = Triggered | Over Current Protection (OCP) |

TABLE 4-12 REGISTER of Protection Status

[STATe :] CCR {AUTO | R2}

Command Syntax:

[STATe :] CCR {AUTO | R2} { ; | NL}

Purpose: Set the CC MODE RANGE, forcing RANGE II operation if required.

Description: Swaps the unit between AUTO RANGE and RANGE II. AUTO RANGE Will allow the unit to move to the more precise range at low currents, While forcing the unit to remain in RANGE II keeps the range consistent Regardless of the current.

[STATe :] POLAR {POS | NEG}

Command Syntax:

[STATe :] POLAR {POS | NEG} { ; | NL}

Purpose: Sets the polarity displayed by the voltage meter.

Description: The voltage read-out can be set to POS for positive, and NEG for Negative polarity display.

[STATe :] START

Command Syntax:

[STATe :] START { ; | NL}

Purpose: Set for Load to begin the test.

Description: Begins the test, according to the TEST CONFIG (TCONFIG), the load Module will start to test the items and parameters as stored.

[STAtE :] STOP**Command Syntax:**

[STAtE :]STOP { ; | NL }

Purpose: Stops the test, if one is in progress.

- 4.6.4. **SYSTEM** functions allows the user to read the part number of the Load modules and turn RS232 control ON and OFF. Commands are also Available for storing and retrieving load set-ups saved in the memory of the Mainframe. The mainframe has 150 separate memory locations. This is Comprised of 15 memory BANKS with each bank having 10 STATES.

| | 331XF | 333XF | 334XF/G | 33401F/G |
|-------------|-------|-------|---------|----------|
| BANK(n) | 15 | 15 | 15 | 15 |
| STATE(m) | 10 | 10 | 10 | 10 |
| TOTAL STATE | 150 | 150 | 150 | 150 |

[SYStem :] RECall{SP}{m}[,n]**Command Syntax:**

[SYStem :] RECall{SP}{m}[,n] { ; | NL }

Purpose: Recalls the load set-up which has been previously saved in the Memory.**Description:** This command is for recalling the procedure stored in a specified Memory location where:

m = STATE = 1~10

n = BANK = 1~15

If the memory STATE to be used is from the currently selected BANK as shown on the mainframe's display then the BANK [n] can be omitted.

For example:

| | |
|-------------|--|
| RECALL 2,15 | Recalls the load set up saved in the 2 nd STATE and 15 th BANK of the memory. |
| REC 3 | Recalls the load set up from the 3 rd memory STATE from the current BANK as shown on the units front panel display. |

[SYStem :] STORe{SP}{m}{n}

Command Syntax:

[SYStem :] STORe{SP}{m}{n}{ ; |NL}

Purpose: Saves the Load's status to the unit's memory.

Description: This command is for saving the current set up to a specified memory Location where:

m = STATE = 1~10

n = BANK = 1~15

If the memory STATE to be saved to the currently selected BANK then the BANK [n] Part of the command can be omitted.

For example:-

| | |
|-------------|---|
| STORE 2, 15 | Saves the status of the Load to the 2 nd STATE of the 15 th memory BANK. |
| STOR 3 | Saves the load setup to the 3 rd memory STATE of the current BANK as shown on the units front panel display. |

[SYStem :] CHANnel {SP} {1 | 2} [A | B]

Command Syntax:

[SYStem:]CHANnel{ SP }{1 | 2} [A | B] { ; |NL}

[SYStem:]CHANnel? { ; |NL}

Purpose: Select the required Load module or query what the module is selected of 3305F.

Description:

Select the required Load module.

For Example :

CHAN 1→ Choose the 1rd Load module.

CHAN 2B→ Choose the 2rd CHB Load module (For 333XF and 33401F/G).

[SYStem :] NAME?

Command Syntax:

[SYStem :] NAME? { ; |NL}

Purpose: Return the model number of unit

Description: This command is for reading the model number of the Load. If no Module is operating; the display will display "NULL". The model number will be Returned as per TABLE 4-13:

| MODEL | | | |
|-------|-------|---------|--------|
| 3310F | 3330F | 3340F/G | 33401F |
| 3311F | 3332F | 3341F/G | |
| 3312F | 3336F | 3342F/G | |
| 3314F | | 3343G | |
| 3315F | | | |

TABLE 4-13 MODEL NUMBER

[SYStem :] *RST

Command Syntax:

[SYStem :] *RST { ; |NL}

Purpose: 330XF Mainframe reset.

Description: This command is 330XF Mainframe reset.

[SYStem :] REMOTE

Command Syntax:

[SYStem :] REMOTE { ; |NL}

Purpose: Command to enter REMOTE status (only for RS232)

Description: This command is for enabling control of the unit via RS232.

[SYStem :] LOCAL

Command Syntax:

[SYStem :] LOCAL { ; |NL}

Purpose: Command to exit the REMOTE status (only for RS232)

Description: This command closes the RS232 control interface.

SYNC : LOAD {SP}{ON|OFF}

Command Syntax:

SYNC : LOAD{SP}{ON|OFF} { ; |NL}

Purpose: Command to make all electronics loads of machine real LOAD ON or OFF in Same time.

Example : SYNC : LOAD ON

.....

SYNC : LOAD OFF

- 4.6.5. **MEASUREMENTS** – This set of commands allows the programmer to measure The actual voltage at the load terminals and the current being taken.

MEASure : CURRent ?

Command Syntax:

MEASure : CURRent ? { ; |NL}

Purpose: Measures the load current.

Description: Reads the current meter. The engineering unit is Ampere (A)

MEASure : VOLTage ?

Command Syntax:

MEASure : VOLTage ? { ; |NL}

Purpose: Measures the load voltage.

Description: Reads the voltmeter. The engineering unit is Voltage (V)

MEASure : POWER ?

Command Syntax:

MEASure : POWER? { ; |NL}

Purpose: Read the power being taken by the load.

Description: Reads the power meter. The engineering unit is Watt (W)

MEAS : VC ?

Command Syntax:

MEAS : VC?{ ; |NL}

Purpose: Read the voltage and current being taken by the load.

Description: Reads the voltage and current meter, Echo format : "###.####,###.####",
The first number is Voltage (V),the second number is Current(A).

Appendix A GPIB programming Example

C Example Program

```
/* Link this program with appropriate *cib*.obj. */

/* This application program is written in TURBO C 2.0 for the IBM PC-AT compatible. The
National Instruments Cooperation (NIC) Model PC-2A board provides the interface between
the PC-AT and a PRODIGIT MPAL ELECTRONIC LOAD. The appropriate *cib*.obj file is
required in each program to properly link the NIC board to C LANGUAGE. and include the
<decl.h.> HEADER FILE to C LANGUAGE. */

#include <stdio.h>
#include <dos.h>
#include <math.h>
#include "decl.h" /* NI GPIB CARD HEADER FILE */

main()
{
    char ouster[20],rdbuf[15],spec[10];
    int i,ch,load;
    /* Assign unique identifier to the device "dev5" and store in variable load. check for error. ibfind
error = negative value returned. */
    if((load = ibfind("dev5")) < 0)/* Device variable name is load */
    {
        /* GPIB address is 5 */
        printf("\r*** INTERFACE ERROR ! ***\a\n");
        printf("\r\nError routine to notify that ibfind failed.\n");
        printf("\r\nCheck software configuration.\n");
        exit(1);
    }
    /* Clear the device */
    if((ibclr(load)) & ERR);
    {
        printf("INTERFACE ERROR ! \a");
        exit(1);
    }
    clrscr();
    /* Clear load error register */

    ibwrt(load,"CLR",3);

    ibwrt( load,"NAME?",5); /* Get the 3310F series module load specification */
    delay(100);
    strset(rdbuf,'\0'); /* Clear rdbuf string buffer */
    strset(spec,'\0'); /* Clear spec string buffer */
    ibrd(load,spec,20);
    if (spec[3] == '9')
        printf("\n 3305F series specification error !");
}
```



```
/* Set the channel 1, preset off, current sink 1.0 amps and load on commands to the load. */
ibwrt( load,"pres off;curr:low 0.0;curr:high 1.0;load on ",43);
ibwrt( load,"meas:curr ?",10);
delay(100);
/* Get the load actually sink current from the load */
ibrd( load,rdbuf,20);
/* go to local. */
ibloc(load);
```

BASICA Example Program

LOAD DECL.BAS using BASICA MERGE command.

```
100 REM You must merge this code with DECL.BAS
105 REM
110 REM Assign a unique identifier to the device "dev5" and store it in variable load%.
125 REM
130   udname$ = "dev5"
140   CALL ibfind (udname$,load%)
145 REM
150 REM Check for error on ibfind call
155 REM
160   IF load% < 0 THEN GOTO 2000
165 REM
170 REM Clear the device
175 REM
180   CALL ibclr (load%)
185 REM
190 REM Get the 3310 series module load specification
195 REM
200   wrt$ = "NAME?" : CALL ibwrt(load%,wrt$)
210   rd$ = space$(20) : CALL ibrd(load%,rd$)
215 REM
220 REM Set the channel 1, preset off, current sink 1.0 amps and load on commands to the load.
225 REM
230   wrt$ = "pres off;curr:low 0.0;curr:high 1.0;load on"
240   CALL ibwrt(load%,wrt$)
245 REM
250 REM Get the load actually sink current from the load
255 REM
260   wrt$ = "meas:curr?" : CALL ibwrt(load%,wrt$)
270   rd$ = space$(20) : CALL ibrd(load%,rd$)
275 REM
280 REM Go to local
285 REM
290 CALL ibloc(load%)

2000 REM Error routine to notify that ibfind failed.
2010 REM Check software configuration.
2020 PRINT "ibfind error !" : STOP
```

Appendix B 3305F USB Instruction

1. Install the USB DRIVER, select USB\SETUP\PL-2303 Driver Installer.exe.

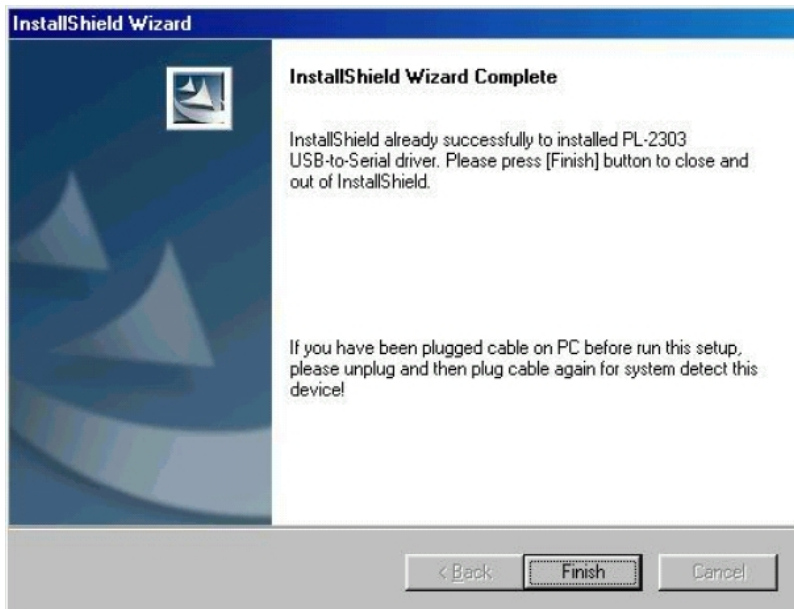
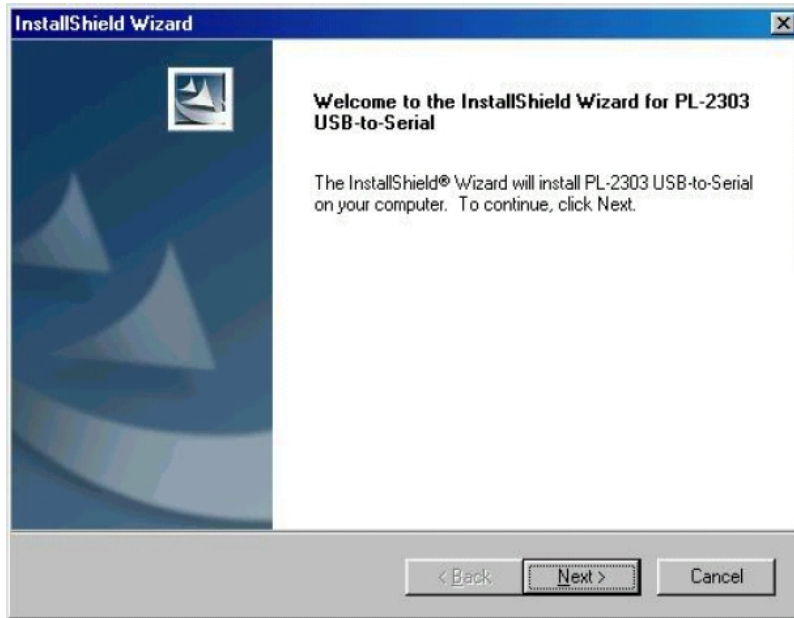

2. After the installation, connect the 3305F and PC with USB. Then select the item USB to Serial Port (COM3), set the BAUD-RATE to 115200bps and the Flow control to Hardware. You should then be able to control the 3305F via USB on COM3.

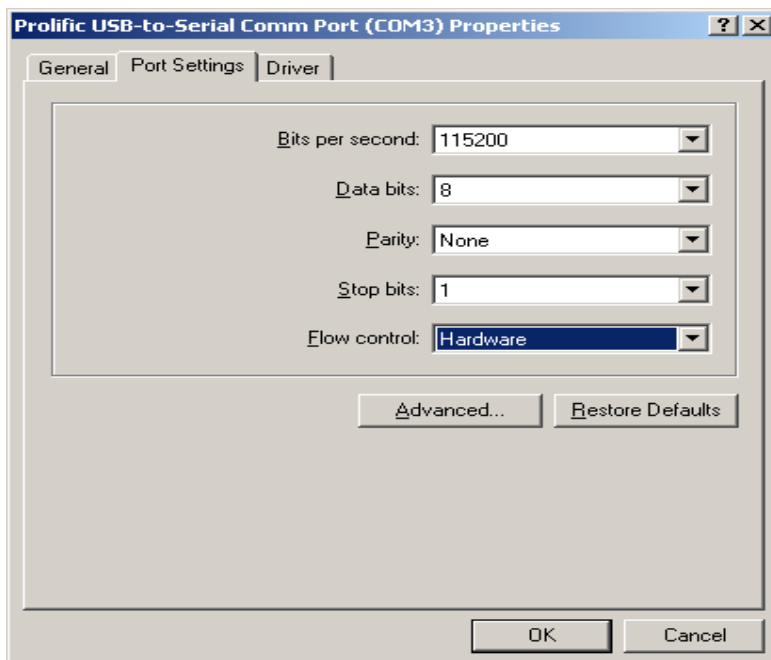
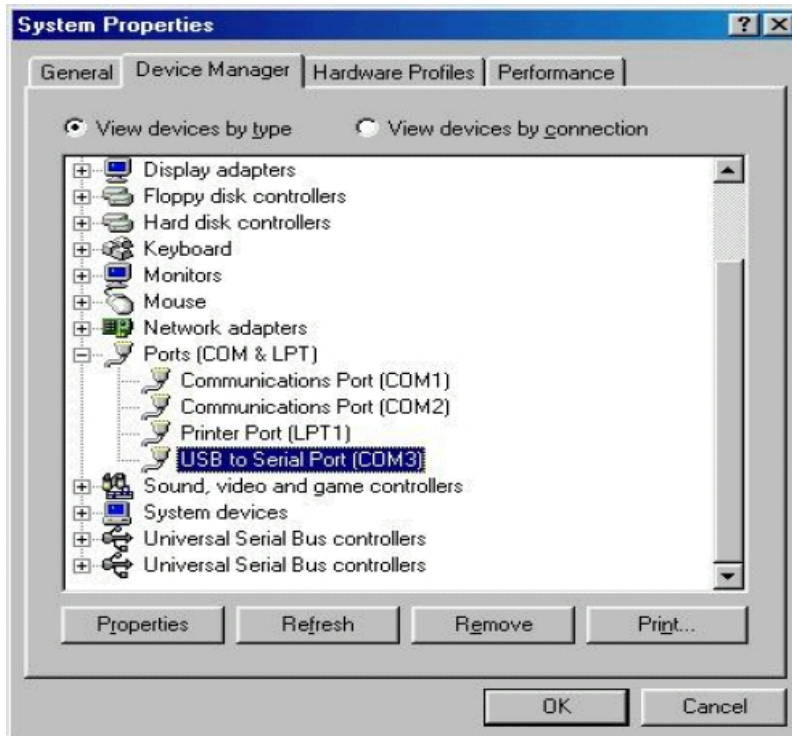

Appendix C: 3305F LAN Installation

1. Connect AC power and the network (LAN) cable to the 3305F mainframe. Connect the other side of the network cable to the existing network.
2. After inserting the driver CD-ROM, run LAN\ETM.EXE from the CD. The Ethernet Manager screen will be displayed as shown in Fig C1-1. If the Ethernet Manager window does not appear then, press F5 to search again (refresh), and check the connections if necessary.

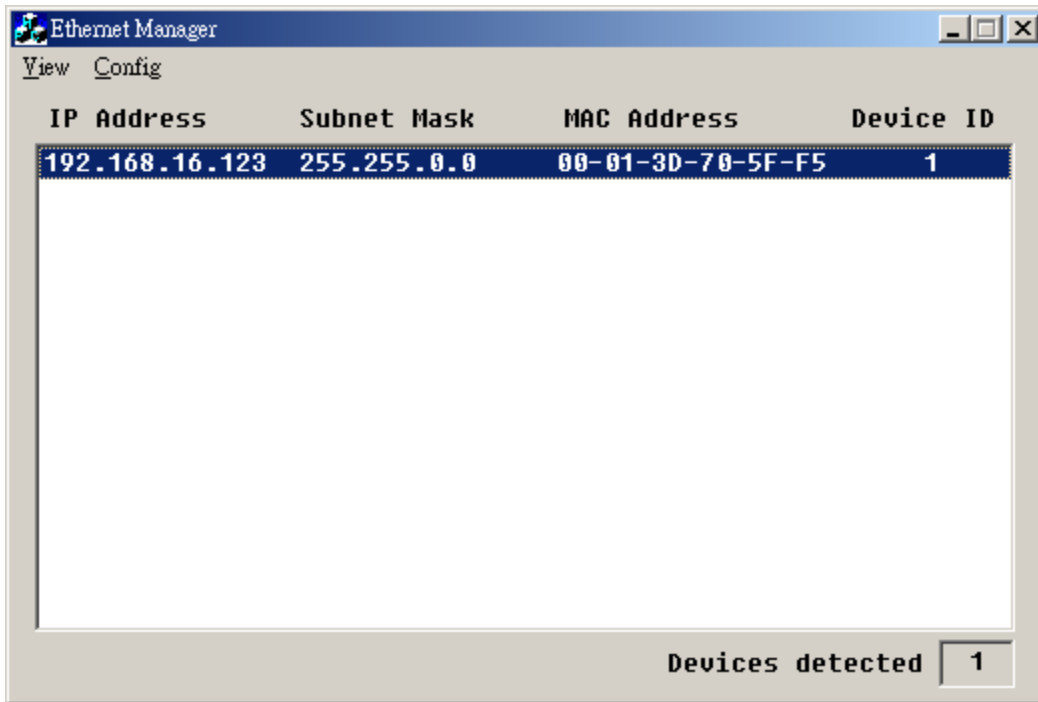

Fig D2-1

3. The connected unit will appear on the list, click it to set the IP Address and Subnet Mask as shown on the following figure.



4. The Controller Setup page should be accessible, once everything is set correctly. This allows greater control over the communications interface.

| Controller Setup | |
|--|------------------|
| IP address | 192.168.16.128 |
| Subnet mask | 255.255.255.0 |
| Gateway address | 0.0.0.0 |
| Network link speed | Auto |
| DHCP client | Enable |
| Socket port of HTTP setup | 80 |
| Socket port of serial I/O | 4001 TCP Server |
| Socket port of digital I/O | 5001 TCP Server |
| Destination IP address / socket port (TCP client and UDP) Connection | 0.0.0.0 0 Auto |
| TCP socket inactive timeout (minutes) | 0 |
| Serial I/O settings (baud rate, parity, data bits, stop bits) | 115200 N 8 1 |
| Interface of serial I/O | RS 232 (RTS/CTS) |
| Packet mode of serial input | Disable |
| Device ID | 1 |
| Report device ID when connected | Disable |
| Setup password | |
| Update | |

5. Insert the following into the controller set up screen:

- a) IP Address: **as recommended according to your network**
- b) Subnet Mask: **as recommended according to your network**
- c) Gateway Address: **as recommended according to your network**
- d) Network link speed: **Auto**
- e) DHCP client: **Enable**
- f) Socket port of HTTP setup: **80**
- g) Socket port of serial I/O: **4001 , TCP Server**
- h) Socket port of digital I/O: **5001 , TCP Server**
- i) Destination IP address / socket port (TCP client and UDP) Connection: **Auto**
- j) TCP socket inactive timeout(minutes) : **Set the network disconnection after N minutes, set 0 minutes will work forever.**
- k) Serial I/O settings (baud rate, parity, data, bits, stop bits): **115200, N, 8, 1**
- l) Interface of serial I/O: **RS 232 (RTS/CTS)**
- m) Packet mode of serial input: **Disable**
- n) Device ID : **5**
- o) Report device ID when connected : **Auto**
- p) Setup password: **Not required**

Appendix D: Auto-Sequence Quick Start with Example

An auto-sequence allows the user to step through previously saved set-ups stored in the mainframe's memory. Up to 9 auto-sequences can be saved. Each auto-sequence can consist of up to 16 steps. There are two modes in the auto-sequence function. These are edit mode to set up an auto-sequence and test mode to recall and start an auto-sequence.

Edit mode

1. Set-up all load parameters such as the operating mode, along with sink values and the LOAD ON/OFF status. Configuration and limit settings can also be set and the NG ON function selected.
2. Press the STORE key and one of the numbered STATE keys to store the set up in one of the memory locations. The BANK can also be changed to provide additional memory locations.
3. Additional load set-ups can then be made and saved to separate memory locations using the STORE, BANK and STATE buttons.
4. Once the required number of load set ups has been saved enter the EDIT mode by pressing the EDIT button.
5. With EDIT button lit the auto-sequence identity (F1 to F9) can be selected using the numbered STATE buttons.
6. Now select the first memory location by pressing the up/down arrow keys to select the BANK and STATE. This will become the first step of the AUTO-SEQUENCE.
7. Press ENTER to set the chosen BANK and STATE memory location
8. Using the arrow keys set the test time (T1) and NG/LIMIT checking time (T2) for that step of the auto-sequence.
9. Press ENTER to save the time setting and move onto the next step of the auto-sequence.
10. Repeat points 6-9 to enter up to 16 steps to form the auto-sequence
11. Once the desired number of steps have been set press the STORE button
12. The LCD will show REP.
13. Use the arrow keys to set the number of auto-sequence repetitions.
14. Press STORE to confirm the sequence edit.

Test mode

1. Press the TEST key on the mainframe to enter the TEST mode
2. Use the numbered STATE keys (1-9) to select the previously saved auto-sequence
3. Press ENTER to start the auto-sequence
4. The LCD shows "PASS" or "FAIL" after testing. (If limits and the NG functions have been set and a test step fails then the LCD will flash NG. The user must then press ENTER to carry on the auto-sequence or EXIT to leave the auto-sequence).

Auto-Sequence Example

In this example, we will create a program based on following Figure. The program executes steps 1 to 8 in sequence.

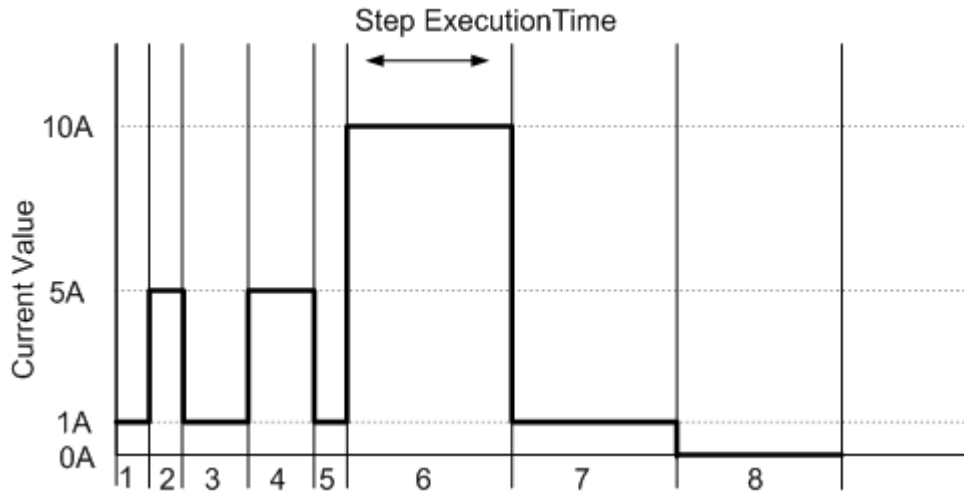

| Auto-sequence Step number | Memory BANK | Memory STATE | Current Value | Execution Time (T1+T2) |
|---------------------------|-------------|--------------|---------------|------------------------|
| 1 | 3 | 1 | 1A | 200mS |
| 2 | 3 | 2 | 5A | 200mS |
| 3 | 3 | 3 | 1A | 400mS |
| 4 | 3 | 4 | 5A | 400mS |
| 5 | 3 | 5 | 1A | 200mS |
| 6 | 3 | 6 | 10A | 200mS |
| 7 | 3 | 7 | 1A | 200mS |
| 8 | 3 | 8 | 0A | 200mS |

Creating the Auto-Sequence

1. Set the operation mode: Press the mode key to CC mode.
2. Set the range: Press RANGE key to force range 2
3. Set LOAD ON/OFF Status: Press Load ON
4. Set the current values steps 1~8 and store to memory BANK 3 STATES 1~8
5. Press EDIT key of 3305F mainframe
6. Press the number 2 key to select F2 as the auto sequence location
7. Press up/down key to memory bank 3 and state 1
8. Press ENTER key to confirm the sequence memory
9. Press up/down key to set the test time for that step (T1+ T2)
10. Press ENTER key to confirm the sequence step
11. Repeat 7~10 to set auto-sequence steps 1~8
12. After setting final step press the STORE key
13. Press up/down key to 1 to repeat the auto-sequence one time
14. Press STORE key to confirm the number of repetitions.
15. Press TEST key to enter TEST mode
16. Press number 2 to select auto-sequence F2
17. Press ENTER to confirm selection and start TEST
18. The load will then step through the auto-sequence.
The testing waveforms on the right will be apparent assuming that the DC Source can supply the set load current

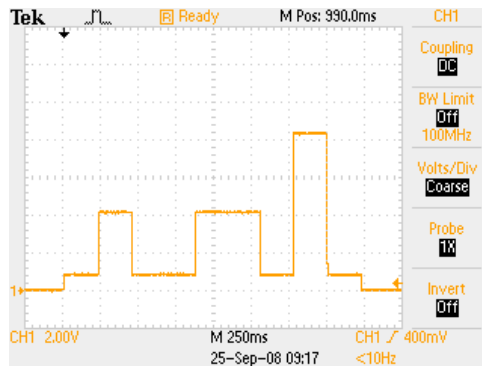

Testing Waveform

Appendix E: Short, OPP and OCP test examples

The parameters for the Short, Over Power Protection and Over Current Protection tests can be programmed over the optional computer interfaces. The following examples may prove useful.

SHORT Test

This example sets a short test for 500ms until the STOP command is received.

```
REMOTE          ( Set Remote )
TCONFIG SHORT   ( Set SHORT test function )
STIME 500       ( Sets short time to 500ms time)*
START           ( Start SHORT testing )
TESTING?       ( Ask Testing? 1 : Testing , 0 : Testing End )
STOP           ( Stop SHORT testing )
```

* if 500 is replaced with 0 the short test is continuous until STOP command

OPP Test

In this example threshold limits are set and the NG signal enabled.

```
REMOTE          ( Set Remote )
TCONFIG OPP     ( Set OCP test )
OPP:START 3     ( Set start load watt 3W )
OPP:STEP 1     ( Set step load watt 1W )
OPP:STOP 5     ( Set stop load watt 5W )
VTH 0.6        ( Set OPP VTH 0.6V )
WL 0           ( Set watt low limit 0W )
WH 5           ( Set watt high limit 5W )
NGENABLE ON    ( Set NG Enable ON )
START          ( Start OPP testing )
TESTING?       ( Ask Testing? 1 : Testing , 0 : Testing End )
NG?           ( Ask PASS/FAIL? , 0 : PASS , 1 : FAIL )
OPP?          ( Ask OPP watt value )
STOP          ( Stop OPP testing )
```

OCP Test

This test will start sink at 3A and increase towards 5A in 1A steps.

```
REMOTE          ( Set Remote )
TCONFIG OCP     ( Set OCP test )
OCP:START 3     ( Set start load current 3A )
OCP:STEP 1     ( Set step load current 1A )
OCP:STOP 5     ( Set stop load current 5A )
VTH 0.6        ( Set OCP VTH 0.6V )
IL 0           ( Set current low limit 0A )
IH 5           ( Set current high limit 5A )
NGENABLE ON    ( Set NG Enable ON )
START          ( Start OCP testing )
TESTING?       ( Ask Testing? 1 : Testing , 0 : Testing End )
NG?           ( Ask PASS/FAIL? , 0 : PASS , 1 : FAIL )
OCP?          ( Ask OCP current value )
STOP          ( Stop OCP testing )
```

