

3330F Series Plug-In Electronic Load module Operation manual

Material Contents Declaration

(材料含量宣称)

(Part Name) 零件名称	Hazardous Substance (有毒有害物质或元素)					
	铅(Pb)	汞(Hg)	镉(Cd)	六价铬 (Cr6+)	多溴联 苯(PBB)	多溴二苯醚 (PBDE)
PCBA (印刷电路装配件)	X	○	X	○	○	○
Electrical part not on PCBA's 未在PCBA上的电子零件	X	○	X	○	○	○
Metal parts 金属零件	○	○	○	X	○	○
Plastic parts 塑料零件	○	○	○	○	X	X
Wiring 电线	X	○	○	○	○	○
Package 封装	X	○	○	○	○	○

对销售之日的所售产品,本表显示, PRODIGIT 供应链的电子信息产品可能包含这些物质。注意:在所售产品中可能会也可能不会含有所有所列的部件。This table shows where these substances may be found in the supply chain of Prodigit electronic information products, as of the date of sale of the enclosed product. Note that some of the component types listed above may or may not be a part of the enclosed product. ○: 表示该有毒有害物质在该部件所有均质材料中的含量均在SJ/T 11363-2006 标准规定的限量要求以下。○: Indicates that the concentration of the hazardous substance in all homogeneous materials in the parts is below the relevant threshold of the SJ/T 113632006 standard. ×: 表示该有毒有害物质至少在该部件的某一均质材料中的含量超出SJ/T 11363-2006 标准规定的限量要求。×: Indicates that the concentration of the hazardous substance of at least one of all homogeneous materials in the parts is above the relevant threshold of the SJ/T 11363-2006 standard.

Note(注释):

1. Prodigit has not fully transitioned to lead-free solder assembly at this moment ; However, most of the components used are RoHS compliant.

(此刻, Prodigit 并非完全过渡到无铅焊料组装;但是大部份的元器件一至于RoHS的规定。)

2. The product is labeled with an environment-friendly usage period in years.

The marked period is assumed under the operating environment specified in the product specifications.

(产品标注了环境友好的使用期限(年)。所标注的环境使用期限假定是在此产品定义的使用环境之下。)



Example of a marking for a 10 year period:

(例如此标制环境使用期限为10年)

SAFETY SUMMARY

The following general safety precautions must be observed during all phases of operation, service, and repair of this instrument. Failure to comply with these precautions or with specific warnings elsewhere in this manual violates safety standards of design, manufacture, and intended use of the instrument. PRODIGIT assumes no liability for the *customer's failure to comply with these requirements.*

GENERAL

This product is a Safety Class 1 instrument (provided with a protective earth terminal). The protective features of this product may be impaired if it is used in a manner not specified in the operation instructions.

ENVIRONMENTAL CONDITIONS

This instrument is intended for indoor use in an installation category I, pollution degree 2 environments. It is designed to operate at a maximum relative humidity of 80% and at altitudes of up to 2000 meters. Refer to the specifications tables for the ac mains voltage requirements and ambient operating temperature range.

BEFORE APPLYING POWER

Verify that the product is set to match the available line voltage and the correct fuse is installed.

GROUND THE INSTRUMENT

This product is a Safety Class 1 instrument (provided with a protective earth terminal). To minimize shock hazard, the instrument chassis and cabinet must be connected to an electrical ground. The instrument must be connected to the ac power supply mains through a three conductor power cable, with the third wire firmly connected to an electrical ground (safety ground) at the power outlet. Any interruption of the protective (grounding) conductor or disconnection of the protective earth terminal will cause a potential shock hazard that could result in personal injury.

FUSES

Only fuses with the required rated current, voltage, and specified type (normal blow, time delay, etc.) should be used. Do not use repaired

fuses or short circuited fuse holder. To do so could cause a shock or fire hazard.

DO NOT OPERATE IN AN EXPLOSIVE ATMOSPHERE.

Do not operate the instrument in the presence of flammable gases or fumes.

KEEP AWAY FROM LIVE CIRCUITS.

Operating personnel must not remove instrument covers. Component replacement and internal adjustments must be made by qualified service personnel. Do not replace components with power cable connected. Under certain conditions, dangerous voltages may exist even with the power cable removed. To avoid injuries, always disconnect power, discharge circuits and remove external voltage sources before touching components.

DO NOT SERVICE OR ADJUST ALONE.

Do not attempt internal service or adjustment unless another person, capable of rendering first aid and resuscitation, is present.

DO NOT EXCEED INPUT RATINGS.

This instrument may be equipped with a line filter to reduce electromagnetic interference and must be connected to a properly grounded receptacle to minimize electric shock hazard. Operation at line voltages or frequencies in excess of those stated on the data plate may cause leakage currents in excess of 5.0 mA peak.

DO NOT SUBSTITUTE PARTS OR MODIFY INSTRUMENT.

Because of the danger of introducing additional hazards, do not install substitute parts or perform any unauthorized modification to the instrument. Return the instrument to a PRODIGIT ELECTRONICS Sales and Service Office for service and repair to ensure that safety features are maintained.

Instruments which appear damaged or defective should be made inoperative and secured against unintended operation until they can be repaired by qualified service personnel.



EC DECLARATION OF CONFORMITY

We **Prodigit Electronics Co., Ltd.** declares under our own responsibility that the product

DC Electronic Load

(Model No.: 3330F, 3332F, 3336F, 3300F, 3337F)

satisfies all the technical relations application to the product within the scope of council:

Directive: 2014/30/EU; 2014/35/EU; 2015/863/EU; 2012/19/EU

The above product is in conformity with the following standards or other normative documents

Harmonized Standard :

- EN 61010-1: 2010+A1:2019
- EN IEC 61010-2-030:2021+A11:2021
- EN 61326-1:2013
- EN 61326-2-1:2013

Reference Basic Standards :

Emission:

- EN 55011: 2016+A1: 2020 Class A
- EN 55032: 2015+A1: 2020
- EN 61000-3-2: 2014
- EN 61000-3-3: 2013

Immunity:

- EN 61000-4-2: 2009
- EN 61000-4-3: 2006+A2:2010
- EN 61000-4-4: 2012
- EN 61000-4-5: 2014+A1:2017
- EN 61000-4-6: 2014
- EN 61000-4-8: 2010
- EN 61000-4-11: 2020

Company Name : Prodigit Electronics Co., Ltd.

Company Address : 8F, No.88, Baojhong Rd., Sindian District, New Taipei City, Taiwan.

Person is responsible for marking this declaration:



Manufacturer/Importer

Signature:

Date: **2022/10/20** Name:

Dean Wang

Dean Wang
R&D Assistant Manager



UK Declaration of Conformity

We Prodigit Electronics Co., Ltd. declares under our own responsibility that the product

DC Electronic Load

(Model No.: 3330F, 3332F, 3336F, 3300F, 3337F)

satisfies all the technical relations application to the product within the scope of council:

Directive: **Electromagnetic Compatibility Regulations 2016; Electrical Equipment (Safety) Regulations 2016; the Restriction of the Use of Certain Hazardous Substances in Electrical and Electronic Equipment Regulations 2012**

The above product is in conformity with the following standards or other normative documents

Harmonized Standard :

BS EN 61010-1:2010+A1:2019 ; BS EN IEC 61010-2-030:2021+A11:2021
BS EN 61326-1: 2013 ; BS EN 61326-2-1: 2013

Reference Basic Standards :

Emission:

BS EN 55011: 2016+A1: 2020 Class A
BS EN 55032: 2015+A1: 2020
BS EN 61000-3-2: 2014
BS EN 61000-3-3: 2013

Immunity:

BS EN 61000-4-2: 2009
BS EN 61000-4-3: 2006+A2:2010
BS EN 61000-4-4: 2012
BS EN 61000-4-5: 2014+A1:2017
BS EN 61000-4-6: 2014
BS EN 61000-4-8: 2010
BS EN 61000-4-11: 2020

Company Name : Prodigit Electronics Co., Ltd

Company Address : 8F, No.88, Baojhong Rd., Sindian District, New Taipei City,
Taiwan

Person is responsible for marking this declaration:



Manufacturer/Importer
Signature:

Date: **2022/10/20** Name:

Dean Wang

Dean Wang
R&D Assistant Manager

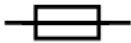
SAFETY SYMBOLS**Direct current (DC)****Alternating current (AC)****Both direct and alternating****Three-phase alternating current****Protective earth (ground)****On (Supply)****Off (Supply)****Fuse****Caution ! Refer to this manual before using the meter.****Caution, risk of electric shock**

CAT IV – Is for measurements performed at the source of the low-voltage installation.

CAT III – Is for measurements performed in the building installation.

CAT II – Is for measurements performed on circuits directly connected to the low-voltage installation.

CAT I – Is for measurements performed on circuits not directly connected to Mains.

3330F series module load operation manual

Table of Contents

Chapter 1 Introduction	9
1-1. GENERAL DESCRIPTION	9
1-2. FEATURES	15
1-3. ACCESSORIES	15
1-4. SPECIFICATIONS	17
Chapter 2 Installation	21
2-1. INSTALLATION AND REMOVAL OF 3330F SERIES PLUG IN MODULE	22
2-2. ENVIRONMENTAL REQUIREMENTS	23
2-3. OBSERVE THE INTERNATIONAL ELECTRICAL SYMBOL LISTED BELOW.	23
2-4. CLEANING	23
2-5. POWER UP	23
2-6. CONNECTION TO THE LOAD INPUT TERMINAL ON THE FRONT PANEL	23
2-7. OPERATING FLOW CHART FOR EACH LOAD MODULE OPERATION	24
Chapter 3 Operation	25
3-1 . INSTRUCTIONS	26
3-2 INITIAL SETTING OF 3330F SERIES LOAD MODULE	41
3-3 INPUT TERMINAL AND WIRE CONSIDERATION	43
3-4 . PROTECTION FEATURES	45
Chapter 4 Applications	46
4-1 LOCAL SENSE CONNECTIONS	46
4-2 REMOTE SENSE CONNECTIONS	46
4-3 CONSTANT CURRENT MODE APPLICATION	48
4-4 CONSTANT VOLTAGE MODE APPLICATION	50
4-5 CONSTANT RESISTANCE MODE APPLICATION	51
4-6 CONSTANT POWER MODE APPLICATION	52
4-7 CONNECTION OF A MULTIPLE OUTPUT POWER SUPPLY	53
4-8 PARALLEL OPERATION	54
4-9 ZERO-VOLT LOADING APPLICATION	55
4-10 3330F SERIES ELECTRONIC LOAD OCP, OPP, SHORT OPERATION FLOW	56
CHART	56
4-11 POWER SUPPLY OCP TESTING	57
4-12 POWER SUPPLY OPP TESTING	62
4-13 POWER SUPPLY SHORT TESTING	67

Figures

Fig 1-1 3330FCHA 80V/60A/250W power contour	9
Fig 1-2 3330F CHB 80V/6A/50W power contour.....	9
Fig 1-3 3332F CHA & CHB 80V/24A/120W power contour	10
Fig 1-4 3336F CHA & CHB 80V/3A/40W power contour.....	10
Fig 1-5 3337F CHA & CHB 80V/30A/150W power contour	10
Fig 1-6 Constant Current mode	11
Fig 1-7 Constant Resistance mode	11
Fig 1-8 Constant Voltage mode.....	12
Fig 1-9 Constant Power mode	12
Fig 1-10 Dynamic Wave form	13
Fig 1-11 Rise Time Transition Limitation	14
Fig 2-1 Binding post and withdraw handle on the front panel of 3330F series Plug-in load module	21
Fig 2-2 Plug-in installation and removal	22
Fig 2-3 3330F series electronic load module load condition setting flow chart.....	24
Fig 3-1 Front panel of 3330F plug-in module.....	25
Fig 3-2 typical connection of 3330F series load module	40
Fig 3-3 Hook Terminal Y type large size terminal connections	43
Fig 4-1 Local voltage sense connections.....	46
Fig 4-2 Remote voltage sense connections	47
Fig 4-3 constant CURRENT mode application	48
Fig 4-4 Dynamic load current with independent programmed Rise/Fall slew rate	49
Fig 4-5 Constant Voltage mode application	50
Fig 4-6 Constant Resistance mode Application	51
Fig 4-7 CONSTANT POWER MODE APPLICATION.....	52
Fig 4-8 Connection between 3330F series plug-in load and multiple output power supply.....	53
Fig 4-9 3330F series plug-in module parallel operation	54
Fig 4-10 Zero-Volt loading connection	55

Tables

Table 1-1 3330F Series Specification	20
Table 3-1 3330F CHA initialize.....	41
Table 3-2 3330F CHB initialize.....	41
Table 3-3 3332F CHA & CHB initialize	42
Table 3-4 3336F CHA & CHB initialize	42
Table 3-5 3337F CHA & CHB initialize	42
Table 3-6 Stranded Copper Wire Ampere Capacity.....	44

Chapter 1 Introduction

1-1. General description

3330F series electronic load is designed to test the evaluation of the DC power supply specifications of features, battery life characteristics of electronic components and specifications for such purposes.

3330F series electronic load modules can be operated on the 3300F, 3302F, 3305F Electronic Load mainframe, work in the 3300F, 3302F, 3305F, 150 sets store/recall memory of mainframe, GPIB/RS232/USB/LAN interface and panel can be manually operated action, on the 3300F, 3302F, 3305F, please refer to the machine frame of the operating manual.

The power contour of 3330F CHA 250 watts Electronic Load is shown in Fig 1-1; it has an input from 0-60A, and 0-80V current and voltage operating range respectively. The power contour of 3330F CHB (80V, 6A, 50W), 3332F CHA and CHB (80V, 24A 120W), 3336F CHA and CHB (80V, 3A, 40W), 3337F CHA and CHB (80V, 30A 150W) Electronic Load are shown in Fig 1-2, 1-3 and 1-5 respectively.

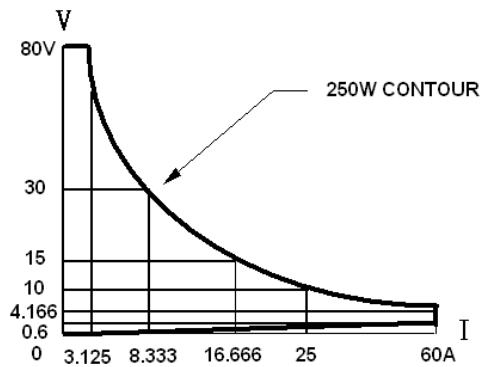

Fig 1-1 3330FCHA 80V/60A/250W power contour

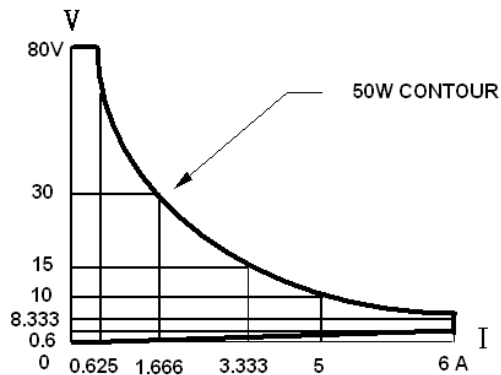

Fig 1-2 3330F CHB 80V/6A/50W power contour

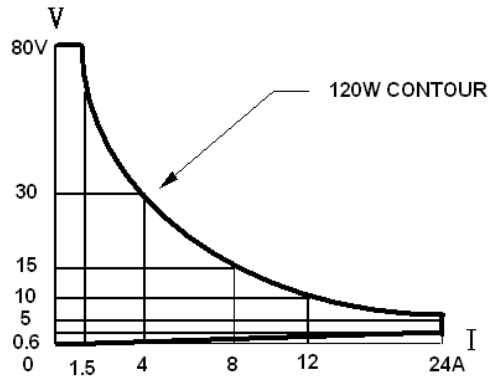

Fig 1-3 3332F CHA & CHB 80V/24A/120W power contour

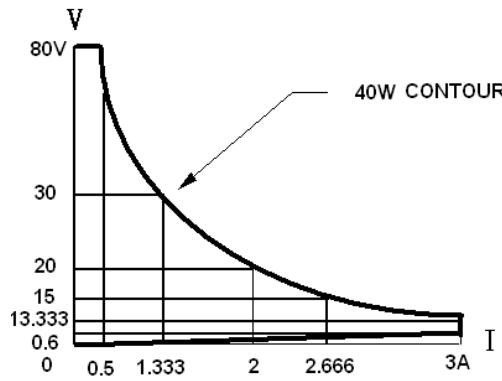

Fig 1-4 3336F CHA & CHB 80V/3A/40W power contour

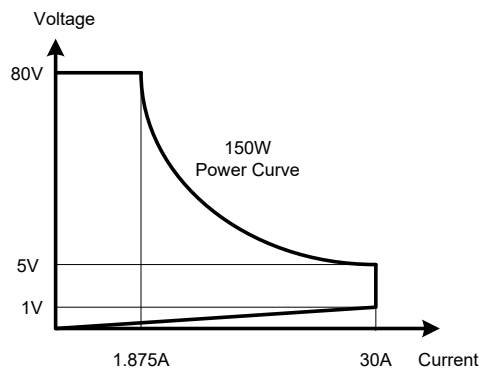

Fig 1-5 3337F CHA & CHB 80V/30A/150W power contour

The operating mode of 3330F series Electronic Load includes Constant Current (CC) mode, Constant Resistance (CR) mode, Constant Voltage (CV) mode, and Constant Power (CP) mode. The wide-range dynamic load with independent rise/fall current slew rate and analog programming input with arbitrary waveform input is available in Constant Current and Constant Power mode, this feature enable 3330F series electronic load to simulate real world load.

CC Mode:

With the operating mode of Constant Current, the 3330F series electronic load will sink a current in accordance with the programmed value regardless of the input voltage (see Fig.1-6).

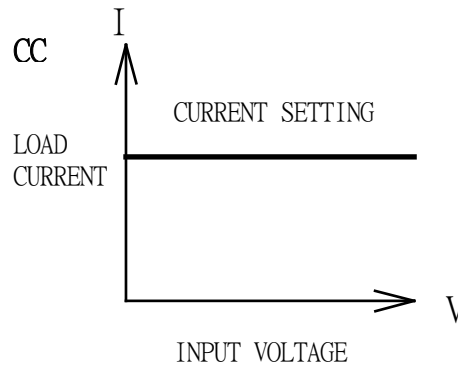

Fig 1-6 Constant Current mode

CR Mode:

At Constant Resistance mode, the 3330F series Electronic Load will sink a current linearly proportional to the load input voltage in accordance with the programmed resistance setting (see Fig 1-7).

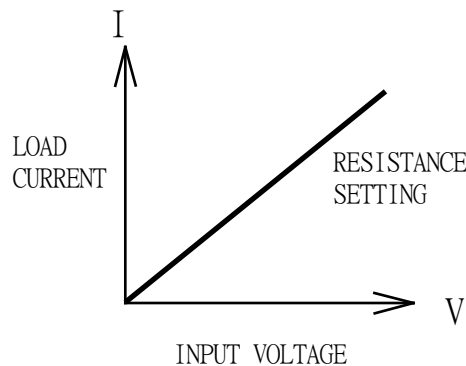

Fig 1-7 Constant Resistance mode

CV Mode:

At Constant Voltage mode, the 3330F series Electronic Load will attempt to sink enough current until the load input voltage is equaled to the programmed value (see Fig 1-8).

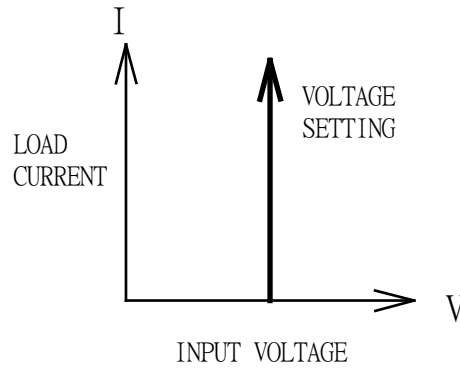

Fig 1-8 Constant Voltage mode

CP Mode:

At Constant Power mode, the 3330F series Electronic Load will attempt to sink load power (load voltage x load current) in accordance with the programmed power. (see Fig 1-9).

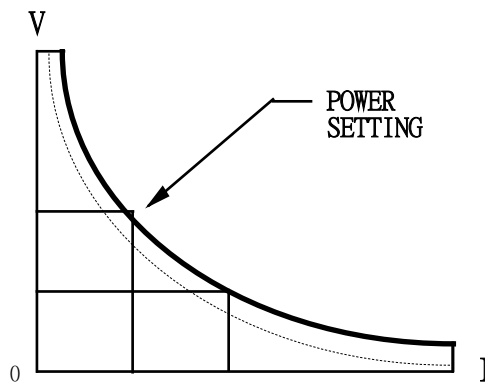

Fig 1-9 Constant Power mode

Dynamic wave form definition:

There are six parameters to generate dynamic wave form or pulse wave form, the 3330F series Electronic Load will sink current from power source proportional to the dynamic wave form, the dynamic wave form definition is shown in Fig 1-10. The period of dynamic wave form is $T_{high} + T_{low}$, dynamic frequency = $1 / (T_{high} + T_{low})$, the Duty cycle = $T_{high} / (T_{high} + T_{low})$

The Dynamic load can simulate real world load condition, it provides a better testing and evaluation for the power source products, the dynamic loading is available for CC (Constant Current) and CP (Constant Power) mode.

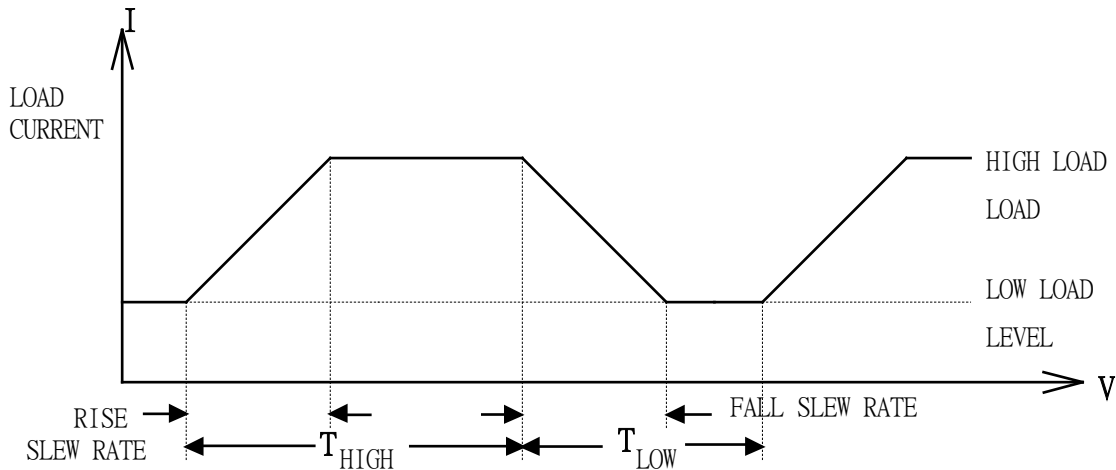

Fig 1-10 Dynamic Wave form

The load current level and load status can be set on Front panel of each load module, mainframe store/recall memory, or GPIB/RS-232 command through mainframe interface, it is called module operation, mainframe store/recall operation, and GPIB/RS-232 remote operation respectively, the load input voltage and load current can be read back to computer through GPIB or RS-232 bus.

The mainframe store/recall and GPIB/RS-232 remote operation is described in 3300F/3302F/3305F mainframe's operation manual.

Slew Rate:

Slew rate is defined as the change in current or voltage over time. A programmable slew rate allows a controlled transition from one load setting to another to minimize induced voltage drops on inductive power wiring, or to control induced transients on a test device (such as would occur during power supply transient response testing).

In cases where the transition from one setting to another is large, the actual transition time can be calculated by dividing the voltage or current transition by the slew rate. The actual transition time is defined as the time required for the input to change from 10% to 90% or from 90% to 10% of the programmed excursion. In cases where the transition from one setting to another is small, the small signal bandwidth of the load limits the minimum transition time for all programmable slew rates. Because of this limitation, the actual transition time is longer than the expected time based on the slew rate, as shown in Figure 1-11

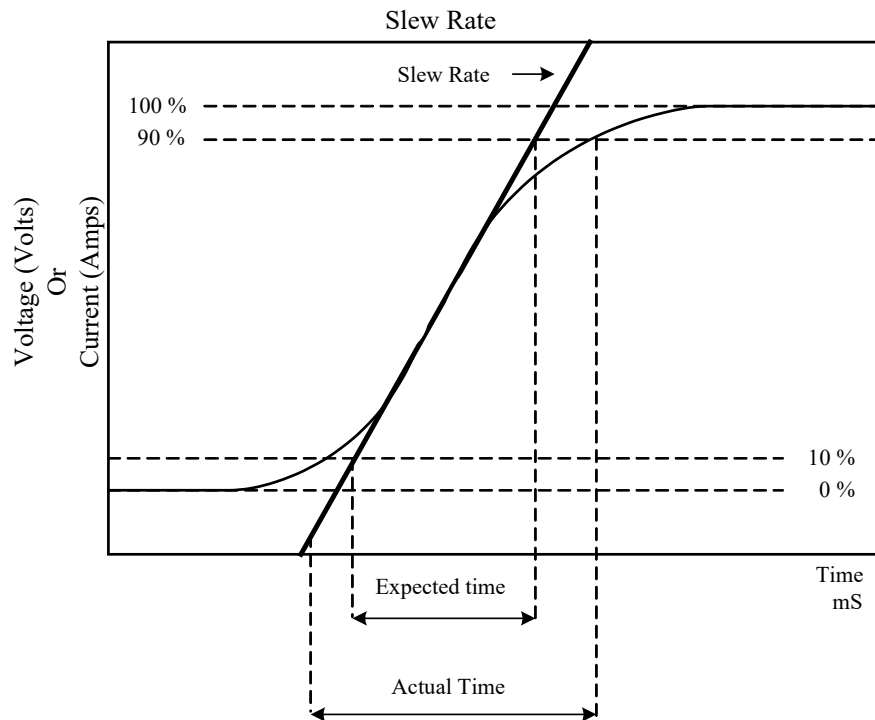

Fig 1-11 Rise Time Transition Limitation

Therefore, both minimum transition time and slew rate must be considered when determining the actual transition time.

Following detail description is exclude in operation manual.

The minimum transition time for a given slew rate as about a 30% or greater load change, The slew rate increases from the minimum transition time to the Maximum transition time at a 100% load change. The actual transition time will be either the minimum transition time, Or the total slew time (transition divided by slew rate), whichever is longer.

Use the following formula to calculate the minimum transition time for a given slew rate

Min transition time = $18 / \text{slew rate (in amps/second)}$.

$$7.2\mu\text{S} (18\text{A} / 2.5) \times 0.8 (10\% \sim 90\%) = 5.76\mu\text{S}$$

Use the following formula to calculate the maximum transition time for a given slew rate

Max transition time = $60 / \text{slew rate (in amps/second)}$.

$$24\mu\text{S} (60\text{A} / 2.5) \times 0.8 (10\% \sim 90\%) = 19.2\mu\text{S}$$

EX. CCH=12A, CCL=0A Slew Rate = 2.5A, the expected time is 3.84 μS but the actual transition Time will be limited to 5.76 μS

$$4.8\mu\text{S} (12 / 2.5) \times 0.8 (10\% \sim 90\%) = 3.84\mu\text{S}$$

1-2. Features

- 1.2.1 Flexible configuration of plug-in Electronic Load module and mainframe.
- 1.2.2 CC, CR, CV, CP, Dynamic, and Short Operating Mode.
- 1.2.3 RS-232 / GPIB / USB / LAN control interface features, including the setting of the Load condition and voltage current meter read back.
- 1.2.4 Dual -high precision / high-resolution 16-bit voltage, current meter and power meter, And with GO / NG discrimination capability.
- 1.2.5 Built-in pulse generator includes wide Thigh/Tlow dynamic load range, independent Rise/Fall load current slew rate control, and High/Low Load level.
- 1.2.6 Controllable load current slew rate of load level change, load ON/OFF switch Change and power supply turn ON.
- 1.2.7 Short circuit test and current measure capability
- 1.2.8 Automatic Voltage Detecting capabilities and programmable Vsense on / off the set Function.
- 1.2.9 Protection features include over voltage, over current, over power, over Temperature and reverse polarity protection.
- 1.2.10 Digital Calibration
- 1.2.11 Advance Fan speed control
- 1.2.12 Up to 150 Sets Store/Recall EEROM memory

1-3. Accessories

- | | | |
|---|--|------|
| a | 4mm Banana Plug (Red) | 2PC |
| b | 4mm Banana Plug (Black) | 2PC |
| c | 2mm Banana Plug (Red) | 2PC |
| d | 2mm Banana Plug (Black) | 2PC |
| e | Hook Terminal Y type Large size terminal | 4PCS |
| f | 3330F series operation manual | 1PC |

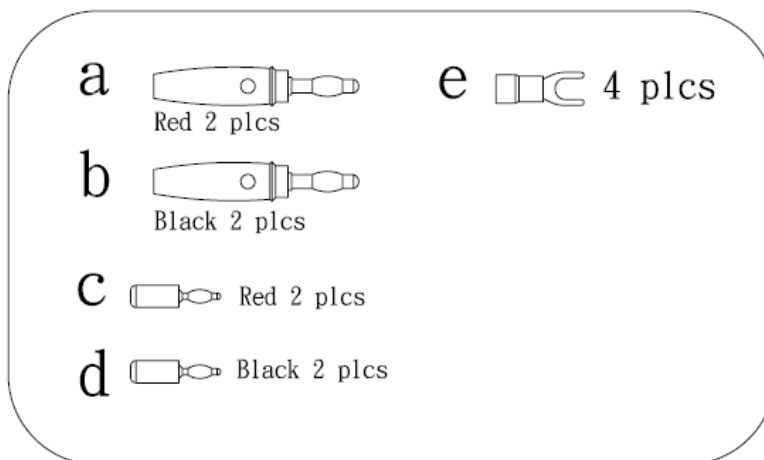

1.3.1 Accessories Installation Description

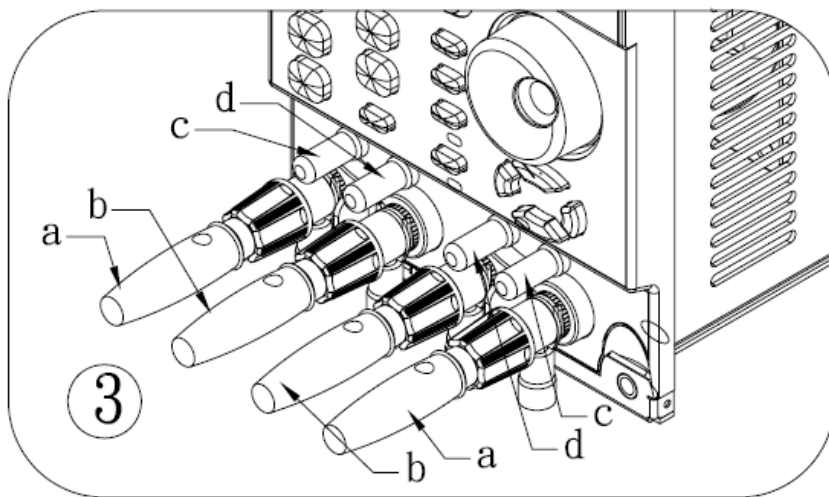
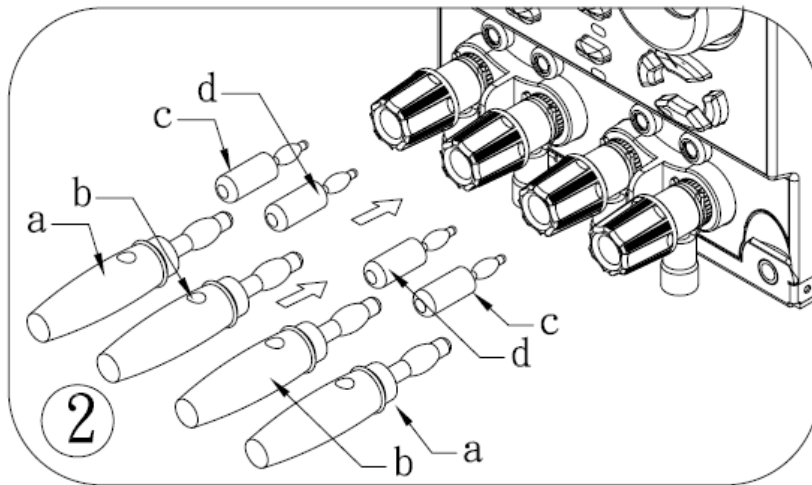
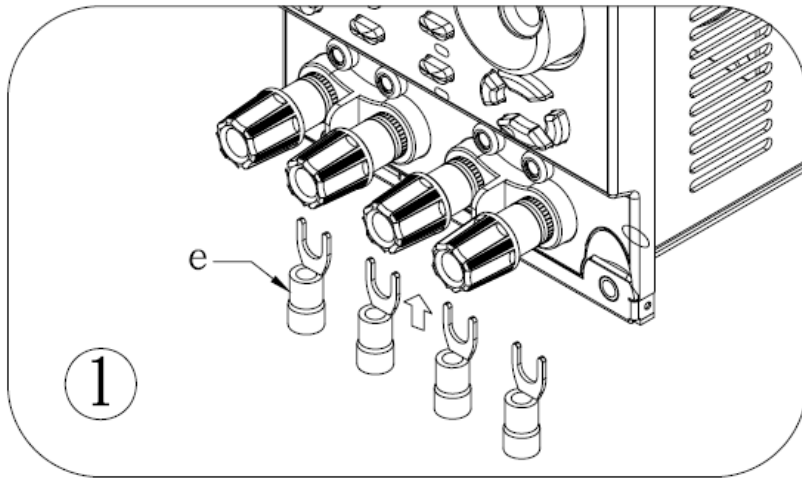

1-4. Specifications

Model	3330F		3332F		3336F	
Power	250W	50W	120Wx2		40Wx2	
Current	0-60A	0-6A	0-24A	0-24A	0-3A	0-3A
Voltage	0-80V	0-80V	0-80V	0-80V	0-80V	0-80V
Min. Operating Voltage	0.8V @ 60A	0.8V @ 6A	0.8V @ 24A	0.8V @ 24A	0.4V @ 3A	0.4V @ 3A
Constant Current Mode						
Range *1	0-6A/60A	0-0.6A/6A	0-2.4A/24A	0-2.4A/24A	0-0.3A/3A	0-0.3A/3A
Resolution	0.1mA/1mA	0.01mA/0.1mA	0.04mA/0.4mA		0.005mA/0.05mA	
Accuracy	± 0.1% (Setting + Range)		± 0.1% (Setting + Range)		± 0.1% (Setting + Range)	
Constant Resistance Mode						
Range	0.01335-1.335-80.1KΩ	0.1335-13.35-801KΩ	0.0333-3.33-199.8KΩ	0.0333-3.33-199.8KΩ	0.267-26.7-1602KΩ	0.267-26.7-1602KΩ
Resolution	22.25μ Ω /12.484μ S	222.5μ Ω /1.2484μ S	55.55μ Ω /5μ S		445μ Ω /0.6242μ S	
Accuracy	0.2% OF (Setting + Range)		0.2% OF (Setting + Range)		0.2% OF (Setting + Range)	
Constant Voltage Mode						
Range	6V/80V	6V/80V	6V/80V	6V/80V	6V/80V	6V/80V
Resolution	0.135mV/1.35mV		0.135mV/1.35mV		0.135mV/1.35mV	
Accuracy	± 0.05% (Setting + Range)		± 0.05% (Setting + Range)		± 0.05% (Setting + Range)	
Constant Power Mode						
Range	25W(I _{max} =6A)/250W	5W(I _{max} =0.6A)/50W	12W(I _{max} =2.4A)/120W	12W(I _{max} =2.4A)/120W	4W(I _{max} =0.3A)/40W	4W(I _{max} =0.3A)/40W
Resolution	0.417mW/4.17mW	0.084mW/0.84mW	0.2mW/2mW	0.2mW/2mW	0.067mW/0.67mW	0.067mW/0.67mW
Accuracy	± 0.5% (Setting + Range)		± 0.5% (Setting + Range)		± 0.5% (Setting + Range)	
Dynamic Mode -CC						
Timing						
Thigh & Tlow	0.050-9.999 / 99.99 / 999.9 / 9999mS		0.050-9.999 / 99.99 / 999.9 / 9999mS		0.050-9.999 / 99.99 / 999.9 / 9999mS	
Resolution	0.001 / 0.01 / 0.1 / 1mS		0.001 / 0.01 / 0.1 / 1mS		0.001 / 0.01 / 0.1 / 1mS	
Accuracy	1uS/10uS/100uS/1mS + 50ppm		1uS/10uS/100uS/1mS + 50ppm		1uS/10uS/100uS/1mS + 50ppm	
Slew rate	4mA-250mA/uS	0.4mA-25mA/uS	1.6mA-100mA/uS	1.6mA-100mA/uS	0.2mA-12.5mA/uS	0.2mA-12.5mA/uS
	40mA-2500mA/uS	4mA-250mA/uS	16mA-1000mA/uS	16mA-1000mA/uS	2mA-125mA/uS	2mA-125mA/uS
Resolution	1mA/10mA	0.1mA/1mA	0.4mA/4mA		0.05mA/0.5mA	
Accuracy	(5% of setting) ± 10 uS					
Min. Rise Time	24uS(typical)		24uS(typical)		24uS(typical)	
Current						
Range	6/60A	0.6A/6A	2.4/24A	2.4/24A	0.3/3A	0.3A/3A
Resolution	0.1mA/1mA	0.01mA/0.1mA	0.04mA/0.4mA		0.005mA/0.05mA	
Accuracy	± 0.1% (Setting + Range)		± 0.1% (Setting + Range)		± 0.1% (Setting + Range)	
Measurement						
Voltage Read Back						
Range (5 Digital)	0-6V/81V	0-6V/81V	0-6V/81V	0-6V/81V	0-6V/81V	0-6V/81V
Resolution	0.1mV/1.35mV		0.1mV/1.35mV		0.1mV/1.35mV	
Accuracy	± 0.025% (Reading + Range)		± 0.025% (Reading + Range)		± 0.025% (Reading + Range)	
Current Read Back						
Range (5 Digital)	0-6A/60A	0-0.6A/6A	0-2.4A/24A	0-2.4A/24A	0-0.3A/3A	0-0.3A/3A
Resolution	0.1mA/1mA	0.01mA/0.1mA	0.04mA/0.4mA		0.005mA/0.05mA	
Accuracy	± 0.1% (Reading + Range)		± 0.1% (Reading + Range)		± 0.1% (Reading + Range)	
Power Read Back						
Range (5 Digital)	0-250W	0-50W	0-120W	0-120W	0-40W	0-40W
Accuracy	± 0.125% (Reading + Range)		± 0.125% (Reading + Range)		± 0.125% (Reading + Range)	
Program mode(Mainframe)						
Sequence No.	F1-9/16 Steps					
T1/T2 (Dwell)	0.1S-9.9S/Repeat 9999					
GO/NG Check	Voltage/Current/Power					
Protections						
Over Power	105% of Rated Power		105% of Rated Power		105% of Rated Power	
Over Current	105% of Rated Current		105% of Rated Current		105% of Rated Current	
Over Voltage	105% of Rated Voltage		105% of Rated Voltage		105% of Rated Voltage	
Over Temp.	Yes		Yes		Yes	
Reverse polarity	Yes		Yes		Yes	

18 PRODIGIT

Interface(Mainframe)			
RS-232	Optional	Optional	Optional
GPIB	Optional	Optional	Optional
USB	Optional	Optional	Optional
Ethernet	Optional	Optional	Optional
Remote Controller	Optional	Optional	Optional
Others			
Load ON Voltage			
Range	0.1-25.0V		
Resolution	0.1V		
Accuracy	1% of Setting + 0.25V		
Load OFF Voltage			
Range	0-25V		
Resolution	0.1mV/1.35mV		
Temperature Coefficient	100ppm/°C(typical)	100ppm/°C(typical)	100ppm/°C(typical)
Power	Supply from Mainframe	Supply from Mainframe	Supply from Mainframe
Operating Temperature ³	0-40°C	0-40°C	0-40°C
Dimension(HxWxD)	143 x 108 x 405 mm/5.6x4.3x15.9 inch	143 x 108 x 405 mm/5.6x4.3x15.9 inch	143 x 108 x 405 mm/5.6x4.3x15.9 inch
Weight	3.5 kg / 7.7 lbs	3.5 kg / 7.7 lbs	3.5 kg / 7.7 lbs
Safety & EMC	CE	CE	CE
Dimension(HxWxD)	143 x 108 x 405 mm/5.6x4.3x15.9 inch	143 x 108 x 405 mm/5.6x4.3x15.9 inch	143 x 108 x 405 mm/5.6x4.3x15.9 inch
Weight	3.5 kg / 7.7 lbs		
Safety & EMC	CE	CE	CE

Model		3337F	
Power	150Wx2		
Current	0~30A	0~30A	
Voltage	0~80V	0~80V	
Min. Operating Voltage	1V @ 30A	1V @ 30A	
Constant Current Mode			
Range *1	0~3A/30A	0~3A/30A	
Resolution	0.05mA/0.5mA		
Accuracy	0.1% + 0.1% F.S.		
Constant Resistance Mode			
Range	0.0443~2.66~159.6KΩ	0.0443~2.66~159.6KΩ	
Resolution	16 bits		
Accuracy	0.2% OF (Setting + Range)		
Constant Voltage Mode			
Range	6V/80V	6V/80V	
Resolution	0.135mV/1.35mV		
Accuracy	0.05% + 0.05% F.S.		
Constant Power Mode			
Range	15W/150W	15W/150W	
Resolution	0.25mW/2.5mW	0.25mW/2.5mW	
Accuracy	0.5% + 0.5% F.S.		
Dynamic Mode -CC			
Timing			
Thigh & Tlow	0.010~9.999 / 99.99 / 999.9 / 9999mS		
Resolution	0.001 / 0.01 / 0.1 / 1mS		
Accuracy	1uS/10uS/100uS/1mS + 50ppm		
Slew rate	2mA~125mA/uS	2mA~125mA/uS	
	20mA~1250mA/uS	20mA~1250mA/uS	
Resolution	8 bits		
Accuracy	(5% of setting) ± 10 uS		
Min. Rise Time	24uS(typical)		
Current			
Range	3/30A	3/30A	
Resolution	0.05mA/0.5mA		
Accuracy	0.1% + 0.1% F.S.		
Measurement			
Voltage Read Back			
Range (5 Digital)	0~6V/80V	0~6V/80V	
Resolution	0.1mV/1mV		
Accuracy	0.025% + 0.025% F.S.		
Current Read Back			
Range (5 Digital)	0~3A/30A	0~3A/30A	
Resolution	0.05mA/0.5mA		
Accuracy	0.1% + 0.1% F.S.		
Power Read Back			
Range (5 Digital)	0~150W	0~150W	
Accuracy	0.125% + 0.125% F.S.		
Program mode(Mainframe)			
Sequence No.	F1~9/16 Steps		
T1/T2 (Dwell)	0.1S~9.9S/Repeat 9999		
GO/NG Check	Voltage/Current/Power		
Protections			
Over Power	105% of Rated Power		
Over Current	105% of Rated Current		
Over Voltage	105% of Rated Voltage		
Over Temp.	YES		
Reverse polarity	No		

Model	3337F	
Interface(Mainframe)		
RS-232	Optional	
GPIB	Optional	
USB	Optional	
Ethernet	Optional	
Remote Controller	Optional	
Others		
Load ON Voltage		
Range	0.1~25.0V	
Resolution	0.1V	
Accuracy	1% of Setting + 0.25V	
Load OFF Voltage		
Range	0~25V	
Resolution	1.35mV	
Accuracy		
General		
Short Circuit		
Current	30A	30A
Typical Short Resistance	0.0443Ω	
Temperature Coefficient	100ppm/°C(typical)	
Power	Supply from Mainframe	
Operating Temperature ^{*3}	0~40°C	
Dimension(HxWxD)	143 x 108 x 405 mm/5.6x4.3x15.9 inch	
Weight	3.5 kg / 7.7 lbs	
Safety & EMC	CE	

Table 1-1 3330F Series Specification

Note *1: The range is automatically or forcing to range II only in CC mode.

Note *2: Power F.S. = Vrange F.S. x Irange F.S.

Note *3 : Operating temperature range is 0~40°C , All specifications apply for 25°C±5°C .

Chapter 2 Installation

This chapter discusses the installation and removal procedure of 3330F series load module and 3300F quad module mainframe; the 3330F series load module does not need any adjustment after plug in the 3330F series load module to any channel of the 3300F mainframe.

It is the same procedures for installation and removal when 3302F single module mainframe is used.

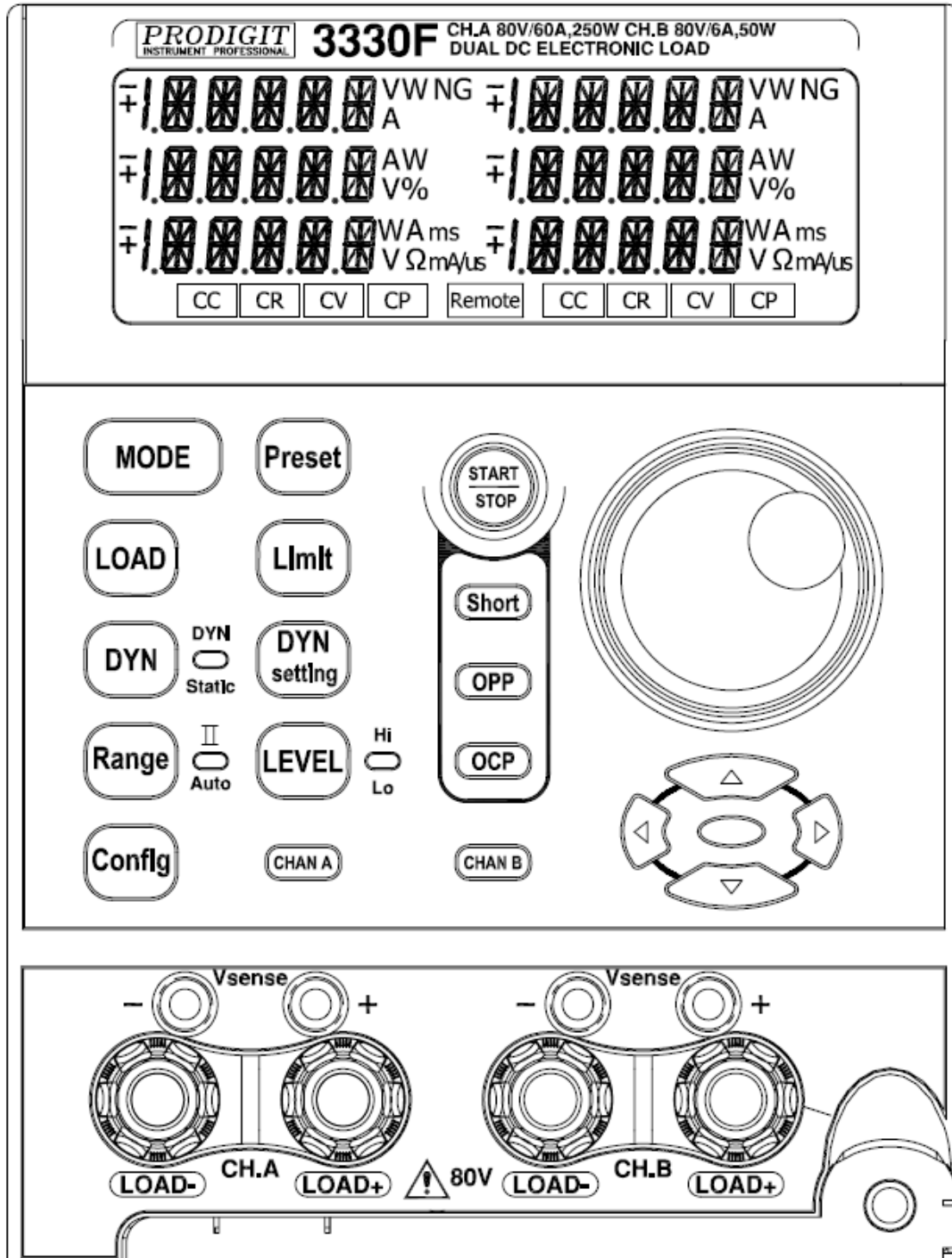

Fig 2-1 Binding post and withdraw handle on the front panel of 3330F series Plug-in load module

2-1. Installation and Removal of 3330F series plug in module

Unless the 3300F/3302F/3305F mainframe and 3330F series Electronic load module were purchased separately, the 3330F series Electronic load module should be installed in the 3300F mainframe before shipment from Prodigit.

The 3330F series Electronic load module operates in 3300F/3302F/3305F mainframe for front panel, Can GPIB, RS232, LAN, USB remote control interface to software programs from the external computer to control, mainframe's 150 sets store/recall and remote control feature.

When you want to install or remove the 3330F series load module in or out from the 3300F /3302F/3305F mainframe for configuration reconfiguration purpose, please follow the procedures which are listed below.

2.1.1. Installation of 3330F series plug-in load:

- 2.1.1.1 Turn the 3300F/3302F/3305F mainframe power OFF before inserting the 3330F series load module, or damage may occur to the plug-in module circuitry.
- 2.1.1.2 Align the upper and lower grooves of the 3300F mainframe with the Upper and lower guides of the selected compartment.
- 2.1.1.3 Push the 3330F series load module in and press firmly on the binding Posts of the front panel to seat the circuit board in the interconnecting Jack.
- 2.1.1.4 Fasten the screw on the lower and right hand side corner of the 3330F Series front panel with screw driver, the screw location is shown on Fig 2-1.
- 2.1.1.5 Turn the 3300F/3302F/3305F mainframe power ON until all of the Electronic modules are completely installed.

2.1.2. Removal of 3330F series plug-in load:

- 2.1.2.1 Turn the 3300F/3302F/3305F mainframe power OFF first; otherwise, Damage may occur to the plug-in circuitry.
- 2.1.2.2 Removal the module by withdraw handle which on the lower and right Hand side of 3330F series front panel.

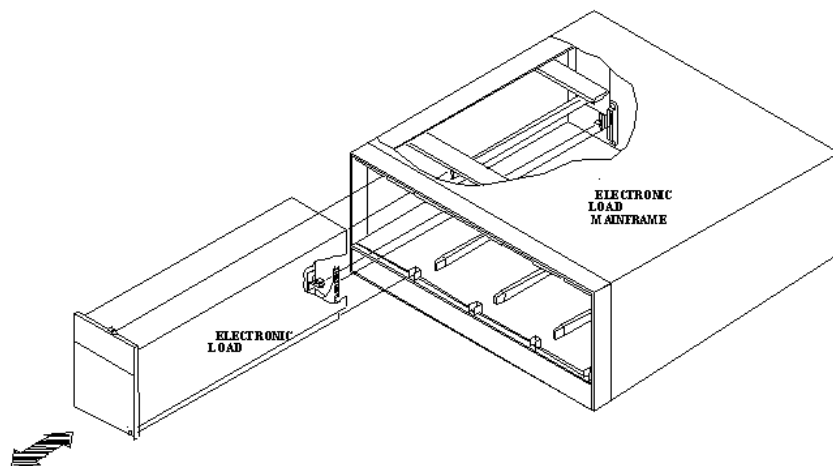



Fig 2-2 Plug-in installation and removal

2-2. Environmental requirements

- 2.2.1. Indoor use
- 2.2.2. Measurement Category I
- 2.2.3. Pollution Degree 2
- 2.2.4. Relative Humidity 80% Max
- 2.2.5. Ambient Temperature 0 ~ 40°C
- 2.2.6. Altitude up to 2000m
- 2.2.7. The equipment is not for measurements performed for CAT II, III and IV.
- 2.2.8. Transient Overvoltage on the mains supply is 2500V.

2-3. Observe the International Electrical Symbol listed below.

 Warning ! Risk of electric shock

 Caution ! Refer to this manual before using the load.

2-4. Cleaning

To clean this product, use a soft or wet cloth.



Before you clean this product, power this product off and disconnect the power plug.

- Please do Not use any organic solvent capable of changing the nature of the plastic such as benzene or acetone.
- Please pay attention that any liquid should not be penetrated into this product.

2-5. Power Up

Operation check

- 2.5.1 Turn off (O) the POWER switch
- 2.5.2 Check that the power cord is corrected.
- 2.5.3 Check that nothing is connected to the DC INPUT (load input terminal) on the Front and rear panels.
- 2.5.4 Turn on the POWER switch.

2-6. Connection to the load Input Terminal on the front Panel

Connection procedure of the load input terminal on the front panel

- 2.6.1 Turn off POWER switch.
- 2.6.2 Check that the output of the equipment under test is off.
- 2.6.3 Connect the load wire to the load input terminal on the front panel.
- 2.6.4 Check the polarity of the connection and connect the load wire to the output Terminal of the equipment under test.

2-7. Operating flow chart for each load module operation

The following flow chart shows the typical load current level and status setting procedures of each load module within 3300F mainframe, the load channel number 1 to 4 is from left to right compartment on 3300F mainframe respectively, please skip Channel setting if single load mainframe 3302F is used.

The string between "____" in the flow chart is a RS-232C or GPIB programming commends.

Please follow the flow chart sequence to have proper and effective load settings.

The load mode (CC, CR, CV, or CP) should be set first, where only Static mode is available for CR and CV mode, both Static and Dynamic modes are available for CC and CP mode, then choose high or Low load level and programming the load level for Static mode, or programming the six parameters for Dynamic mode.

The Limit key set the GO/NG check upper and lower limit for DVM, DAM, and DWM respectively, the system configure setting of V-sense control, Load ON voltage, and load OFF voltage is within the Limit key setting.

Others key (Load ON/OFF, Short ON/OFF) can be controlled independently.

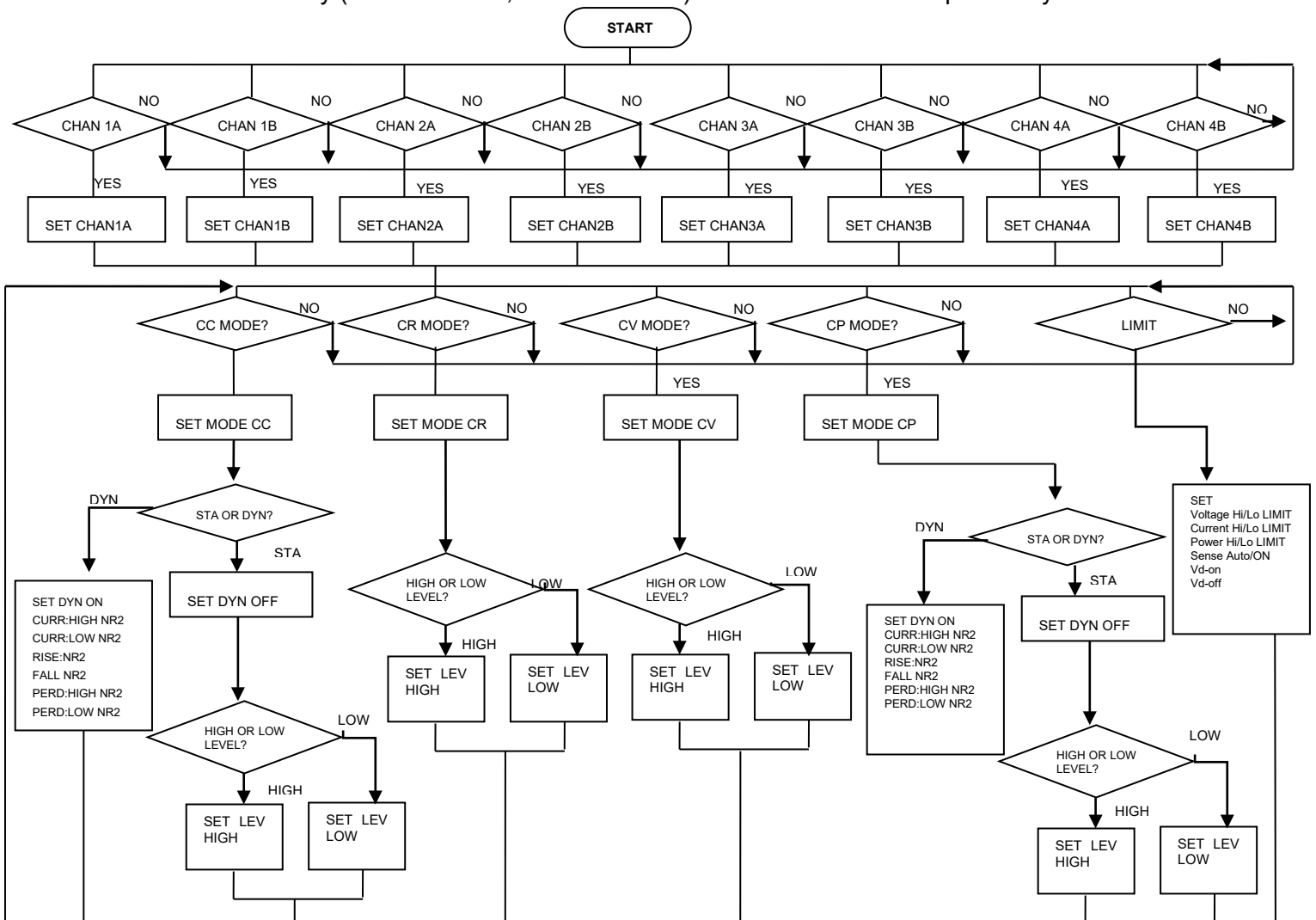

Fig 2-3 3330F series electronic load module load condition setting flow chart

Chapter 3 Operation

This chapter describes the front panel function and operation of each 3330F series load module, the memory Store/Recall, GPIB/RS-232C/USB/LAN remote programming are described in the 3300F/3302F/3305F mainframe operation manual. Please refer to the mainframe's operation manual for mainframe store/recall and GPIB/RS-232C/USB/LAN programming.

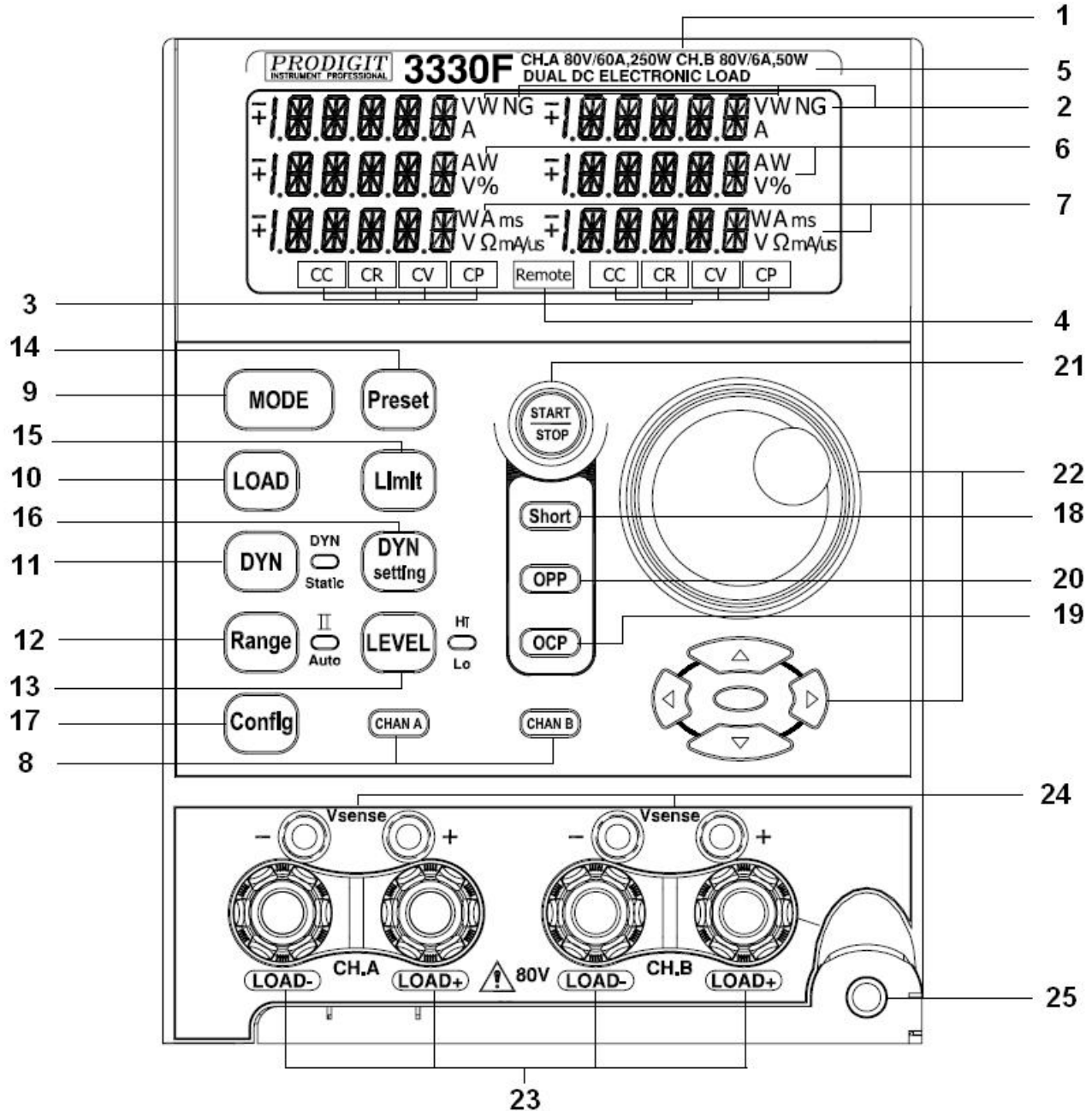

Fig 3-1 Front panel of 3330F plug-in module

3-1 . Instructions

- 3.1.1. 3330F CHA 80V/60A/250W, CHB 80V/6A/50W DC ELECTRONIC LOAD
It indicates the model number and specifications of 3330F series electronic load.



- 3.1.2. 3330F CHA & CHB NG Indicator
3330F CHA indicator when the voltage, current, or power readings exceed the Upper or lower limit setting, this indicator will display NGA, when the voltage, Current or power readings did not exceed the Limit set of upper or lower, namely NGA OFF.

- 3.1.3. MODE and

CC	CR	CV	CP
----	----	----	----

 Indicator
There are four operating modes can be selected by press the " MODE " key on the 3330F series Electronic Load module.

The sequence is Constant Current (CC), Constant Resistance (CR), Constant Voltage (CV), Constant Power (CP) and then repeat while press the" MODE " key, the CC, CR, CV, CP mode LCD will be lit respectively when the appropriate operating mode is selected.

The operating theorem of CC, CR, CV and CP mode is described in Chapter 1-1, and the application information is described in Chapter 4-3, 4-4, 4-5 and 4-6 respectively.

Constant current (CC) mode provides a force Range 2 functions.

- 3.1.4.

Remote

 LCD Indicator
The Remote LCD Indicator is used to indicate the status of remote operation, all of the front panel operation cannot be operated while Remote LCD is ON, in case of Local mode or manual operation, and the Remote LCD is OFF.

- 3.1.5. 3330F CHA and CHB Upper 5 digit LCD display
The 5 digit LCD display is a multi-function display, the functions are described below:

Normal mode:

There is a 5 digit DVM display, display measuring data of the DC input terminal or V-sense input terminal if V-sense AUTO is programmed, or the 5 digit voltage meter displays the voltage of V-sense input terminal if V-sense ON is programmed.

When the auto-sense of V-sense function is programmed, the auto-sense circuit of 3330F series electronic load can check the V-sense cable is connected or not, the V-sense input is detected if it is greater than 0.7V, if yes then the 5 digit DVM measures the sense input, otherwise, the 5 digit DVM measures the DC input terminals of the load module.

Short : Short test Enable and Short Setting programming : Display will show 「 Short 」 .

OPP : OPP test Enable and OPP Setting programming : Display will show 「 OPP 」 .

OCP : OCP test Enable and OCP Setting programming : Display will show 「 OCP 」 .

Short testing、OCP testing and OPP testing programming, will show Vsense's voltage or load Input voltage.

When over voltage protected (The input terminus of electronic load, the voltage exceeds specified value) Display will show 「OVP」.

3.1.6. 3330F CHA and CHB Middle 5 digit LCD display

Normal mode:

There is a 5 digit DAM display. The 5 digit DAM displays the measuring current of the DC load When Load ON programming.

- Limit ON programming : Display will individually show "「V_Hi」, 「V_Lo」, 「I_Hi」, 「I_Lo」, "W_Hi", "W_Lo" and "NG".
- DYN setting ON programming : Display will individually show "「T-Hi」, 「T-Lo」, 「RISE」 and 「FALL」".
- Config ON programming: Display will individually show "「SENSE」, 「LDon」, 「LDoff」 and 「POLAR」".
- Short test Enable、OCP test Enable and OPP test Enable programming: Display will individually show "「PRESS」".
- Short setting programming Display will individually show "「TIME」, 「V-Hi」 and 「V-Lo」".
- OPP setting programming : Display will individually show "「PSTAR」, 「PSTEP」, 「PSTOP」 and 「Vth」".
- OCP setting programming : Display will individually show "「ISTAR」, 「ISTEP」, 「ISTOP」 and 「Vth」".
- Short testing programming, the current of actual load current, the unit is "A".
- OCP testing programming, the setting current, the unit is "A".
- OPP testing programming, the setting watt, the unit is "W"
- When Over current protect(The input terminus of electronic load, the current exceeds specified value) : Display will show "「OCP」".

3.1.7. 3330F CHA and CHB Lower 5 digit LCD display

Normal mode : The Lower 5 digit LCD display is show load Consumption duty.

Setting Mode: Setting value is by rotating knob switch.

- PRESET ON mode display will individually show :
- CC mode's current programming value display, the unit is "A".
- CR mode's resistor programming value display, the unit is "Ω"
- CV mode's voltage programming value display, the unit is "V".
- CP mode's power programming value display, the unit is "W".
- LIMIT ON mode display will individually show :
- V_Hi(upper limit voltage) & V_Lo (lower limit voltage) value display, the unit is "V".
- I_Hi (upper limit current) & I_Lo (lower limit current) value display, the unit is "A".
- W_Hi(upper limit power) & W_Lo (lower limit power) value display, the unit is "W"
- NG programming display will show "「ON」 or 「OFF」".
- DYN setting ON mode display will individually show:
- T-Hi(level high time)& T-Lo(level low time) programming value display, the unit is "ms".
- Rise/Fall current slew rate programming value display, the unit is "A/us" or

- "A/mS".
- Config ON mode display will individually show:
 - SENSE programming display will show 「ON」 or 「AUTO」.
 - LDon & LDoFF value display; the unit are "V".
 - Load polarity value display will show 「+LOAD」 or 「-LOAD」.
 - Short test Enable、OCP test Enable and OPP test Enable mode will show 「START」.
 - Short Setting mode
 - Short setting display will show "CONTI", Short time setting; the unit is "mS".
 - V-Hi & V-Lo value display, the unit is "V".
 - OCP Setting mode
 - OCP ISTAR, OCP ISTEP and OCP ISTOP value display, the unit is "A".
 - OCP Vth value display, the unit is "V".
 - OCP test & OPP test mode display will show 「RUN」
 - OPP Setting mode
 - OPP PSTAR、OPP PSTEP and OPP PSTOP value display, the unit is "W".
 - OPP Vth value display, the unit is "V".
 - When Over power protect : Display will show 「OPP」.
 - When Over temperature protect : Display will show 「OTP」.

- 3.1.8. **CHAN A** Key and LED, **CHAN B** Key and LED
3330F series Electronic Load change CHA mode and CHB mode.

- 3.1.9. **MODE** and **CC** **CR** **CV** **CP** Indicator
There are four operating modes can be selected by press the "MODE" key on the 3330F series Electronic Load module.

The sequence is Constant Current (CC), Constant Resistance (CR), Constant Voltage (CV), Constant Power (CP) and then repeat while press the "MODE" key, the CC, CR, CV, CP mode indicator will be lit respectively when the appropriate operating mode is selected.

- 3.1.10. **LOAD** key and LED

The 3330F series Electronic Load input can be toggled ON/OFF at the front panel's LOAD ON/OFF key. The load current slew rate change uses the slew rate setting, so the load current slew rate will change at the programmed Rise/Fall slew rate setting respectively.

Turning the LOAD OFF does not affect the programmed settings. The LED is OFF to indicate LOAD OFF status. The LOAD will return to the previously programmed values when the LOAD key is turned to ON again.

The Load ON LED indicates the 3330F series electronic load is ready to sink current from DC input.

- Load ON/OFF key: Switch load ON to load OFF in the load module, the fall slew rate is according to the slew rate setting on the front panel.
- DC input voltage: There is a load ON and load OFF voltage control circuit in 3330F series electronic load.
When the Device under Test turns ON, the output voltage of D.U.T will increase up from 0 to rated output voltage. The 3330F series electronic load will start to sink current after load voltage is higher than load ON

voltage setting within the Config key.

- The programmed load ON voltage for model 3330F series load module is from 0 to 25V.
- When the Device under Test turns OFF, the output voltage of D.U.T will decrease down to 0 volt. The 3330F series electronic load will stop to sink current after load voltage is lower than load OFF voltage setting within the Config key.

The programmed load OFF voltage for model 3330F series load module is from 0 to load ON voltage.

- 3.1.11. **DYN** /STA key and LED
This Key is available in Constant Current and Constant Power mode only. In Constant Resistance and Constant Voltage mode, there is no any function in this key and the LED is OFF, the 3330F series load module will automatically adjust to static mode. In Constant Current and Constant Power mode, the Static or Dynamic mode is toggled by this key; the LED will be lit at Dynamic mode.

- 3.1.12. **Range** key and LED
Range AUTO / II Key is for range setting, if Range AUTO LED is OFF, load will setting to Range I or II in accordance with the actual current value. When Range II, LED will ON, the current programming will setting to Range II.

Note1: Coercion Range II only in CC Mode.

Note 2 : CV or CP Mode fixed RANGE II work the way is as follows:

CV (CP) HIGH LEVEL is setting to RANGE II; use LOW LEVEL setting load on from front panel setting.

- 3.1.13. **LEVEL** key and LED
In Static mode, the LEVEL key is used to program the High or Low level load current in Constant Current mode, the High or Low load resistance value in Constant Resistance mode, the High or Low voltage value in Constant Voltage mode, and the High or Low power value in Constant Power mode.

- 3.1.14. **Preset** key and LED
At Preset OFF state, the load input voltage is shown on the upper 5 digit Meter, and load input current is shown on the middle 5 digit Meter, the load input power is shown on the lower 5 digit Meter, the engineering unit "V", "A" and "W" LED will be lit respectively.
At Preset ON state, the PRES. LED is ON, the lower 5 digit Meter will be affected by the CC, Dynamic, CR, CV, and CP operating mode.

In Preset ON condition, the 5 digit DCM indicates the setting load current which cab be from front panel setting or remote system setting.

- In Constant Current mode:
The High/Low level load current value can be preset at lower 5 digit LCD display, the unit is "A", the "A" LED will be lit as well.
- In Dynamic load mode:
The Thigh/Tlow parameters value of High/Low load current duration and Rise/Fall setting can be displayed on the lower 5 digit LCD display, the unit

- is "mS", the "mS" LED will be lit as well.
- In Constant Resistance mode:
The High/Low level load resistance value can be preset on the lower 5 digit LCD display, the engineering unit is "Ω", the "Ω" LED will be lit as well.
- In Constant Voltage mode:
The High/Low level load voltage value can be preset on the upper 5 digit LCD display, the unit is "V", the "V" LED will be lit as well.
- In Constant Power mode:
The High/Low level load power value can be preset on the upper 5 digit LCD display, the unit is "W", the "W" LED will be lit as well.

3.1.15. key and LED

LIMIT key function as follows:

Setting Upper limit voltage and lower limit voltage and upper limit current, and Lower Limit current and upper limit power, and lower limit power and NG ON/OFF. Setting LIMIT key, if press another key to exit the setting, and then jump to press Setting key.

Press LIMIT key to enter setting mode, the indicator LED is lit on, the setting sequence Follows:

- Setting Upper limit voltage VH , Middle 5 digit LCD display 「V-Hi」 ,lower 5 digit LCD display the unit is "V".
- Setting lower limit voltage VL, Middle 5 digit LCD display 「V-Lo」 ,lower 5 digit LCD display the unit is "V".
- Setting Upper limit current AH , Middle 5 digit LCD display 「I-Hi」 ,lower 5 digit LCD display the unit is "A".
- Setting lower limit current AL , Middle 5 digit LCD display 「I-Lo」 ,lower 5 digit LCD display the unit is "A".
- Setting Upper limit power PH, Middle 5 digit LCD display 「W-Hi」 lower 5 digit LCD display the unit is "W".
- Setting lower limit power PL, Middle 5 digit LCD display 「W-Lo」 lower 5 digit LCD display the unit is "W".
- Setting NG ON/OFF, When exceed VH、VL、AH、AL、PH、PH One of these Whether NG on LCD display.

3.1.16. and LED

DYN setting key is setting Dynamic Mode parameter, There are rise, fall, Thigh and Tlow parameters, Setting the parameter is rotating the knob switch. Press any key to escape the DYN parameters setting mode.

- Press DYN setting key, LED will ON
- Setting level High Period, Middle 5 digit LCD display will show 「T-Hi」 Lower 5 digit LCD display will show setting value , the unit is "ms".
- Setting level Low period, Middle 5 digit LCD display will show 「T-Lo」 , Lower 5 digit LCD display will show setting value , the unit is "ms".
- Setting rise time , Middle 5 digit LCD display will show 「RISE」 , Lower 5 digit LCD display will show setting value , the unit is "mA/μs" or "A/uS".
- Setting fall time , Middle 5 digit LCD display will show 「FALL」 , Lower 5 digit LCD display will show setting value , the unit is "mA/μs" or "A/uS".

- 3.1.17. **Config** key and LED
 The Config key setting includes the Sense AUTO/ON, Load ON/OFF voltage and Load Polarity. The setting sequence is shown below.

OFF → SENSE AUTO/ON → Load ON/OFF Voltage → Polarity setting → OFF → Repeat

NOTE1: CC/CR/CP MODE is controlled by Load ON voltage, CV MODE is not Controlled by Load ON voltage

NOTE2: If Load ON voltage Setting 0V, load OFF voltage has to setting to 0V first.

- 3.1.18. **Short** key and LED
- Short test function Enable/Disable Key.
 Press **Short** key to enable the short test function and the indicator LED is lit on. The LCD display show 「SHORT」 on upper 5 digits LCD display, shows 「PRESS」 on middle 5 digits LCD display and shows 「START」 on lower 5 digits LCD display.



- Short test function parameter setting key.
 There are 3 parameter for the SHORT test function. The parameter as TIME, V-Hi and V-Lo.
 Press "SHORT" key again to set short test time when SHORT test function is enabled. Press SHORT key again to next parameter by the sequence of TIME, V-Hi, V-Lo and disable, press another key to exit the setting and save the setting. The short test parameter description as following.

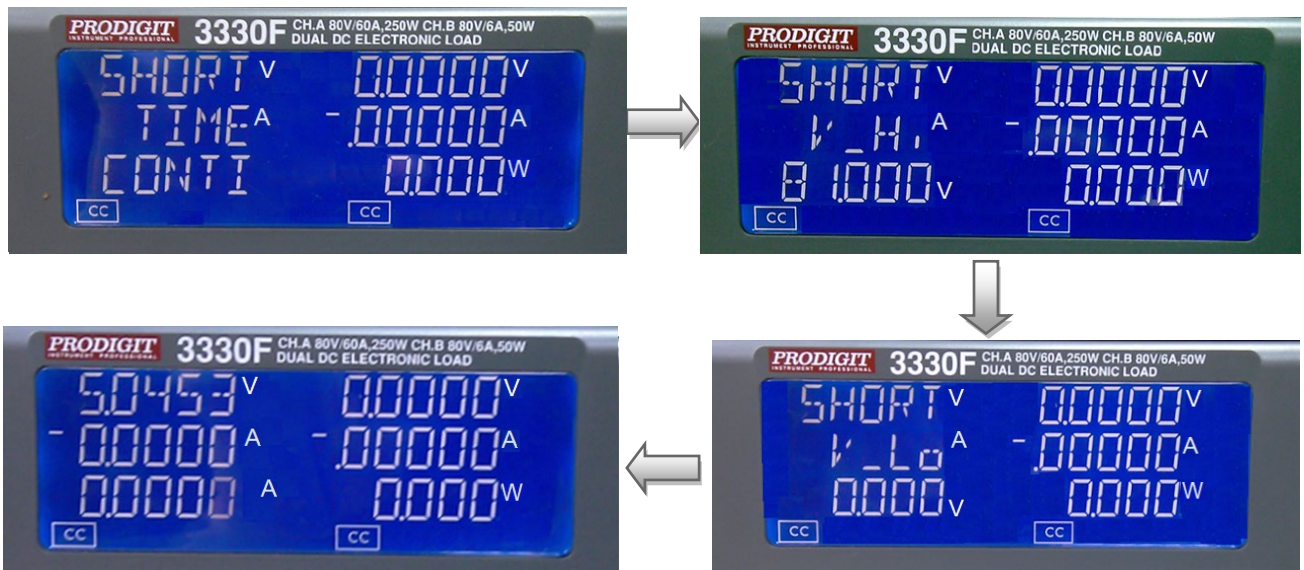

- setting the short test time , The LCD display show 「SHORT」 on upper 5 digits LCD display , shows 「TIME」 on middle 5 digits LCD display , lower 5 digit LCD display 「CONTI」 , the unit is "ms",



- TIME: setting the short test time, The LCD display show 「SHORT」 on upper 5 digits LCD display, shows 「TIME」 on middle 5 digits LCD display the unit is "ms" ,and shows 「CONTI」 on lower 5 digits LCD display, the Setting range is "CONTI" means continue, 100mS to 10000mS step 100mS by clockwise rotate the setting knob. The short test will be no time limitation when setting to CONTI until press "START/STOP" key to stop the short test.

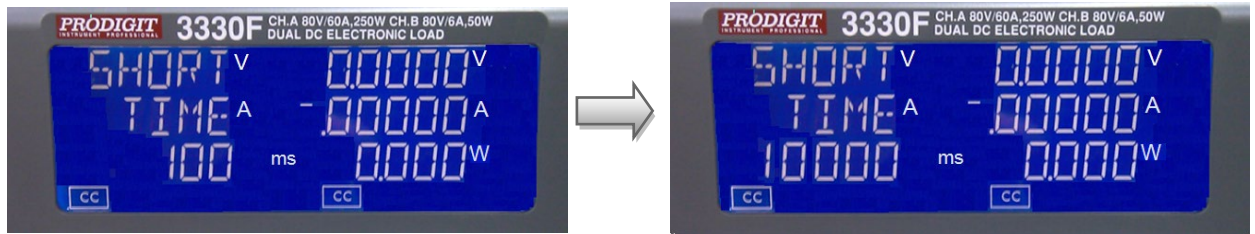

- V-Hi : Short test voltage check upper limitation setting, The LCD display shows 「SHORT」 on upper 5 digit LCD display, Middle 5 digit LCD display 「V-Hi」 ,lower 5 digit LCD display setting value, the unit is "V", The V-Hi setting range from 0.000V to 81.000V step 0.00135V by rotating the setting knob.

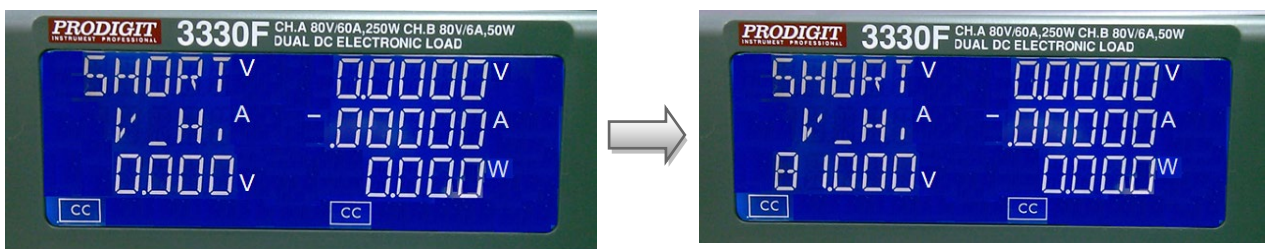

- V-Lo : Short test voltage check lower limitation setting, The LCD display shows 「SHORT」 on upper 5 digit LCD display, Middle 5 digit LCD display 「V-Lo」 ,lower 5 digit LCD display setting value, the unit is "V", the V-Hi setting range from 0.000V to 81.000V step 0.00135V by rotating the setting knob.

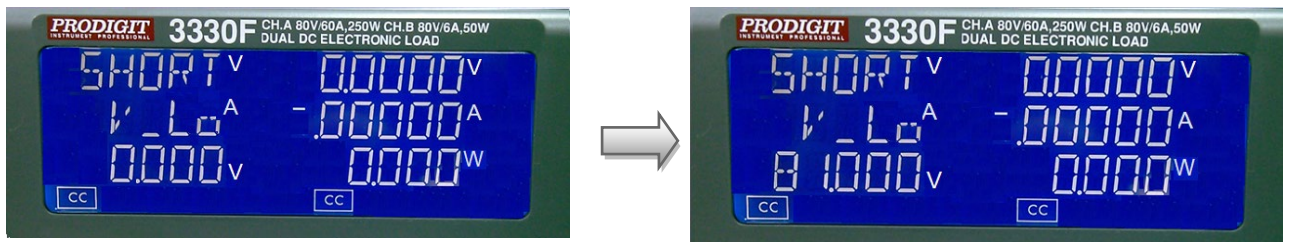

Note. The V-Hi and V-Lo parameter is difference with the V-Hi and V-Lo in the LIMIT function.

3.1.19. **OCP** key and LED

- OCP test function Enable/Disable Key.
Press **OCP** key to enable the OCP test function and the indicator LED is lit on. The LCD display show 「OCP」 on upper 5 digits LCD display, shows 「PRESS」 on middle 5 digits LCD display and shows 「START」 on lower 5 digits LCD display.



- OCP test function parameter setting key.
There are 4 parameter for the OCP test function. The parameter as Istar, Istep, Istop and Vth.

Press “OCP” key again to set OCP test parameter ISTAR (start Current point) When OCP test function is enabled. Press OCP key again to next parameter by the sequence of ISTEP, ISTOP, Vth and disable, press another key also can to exit the setting and save the setting. The OCP test parameter description as following.

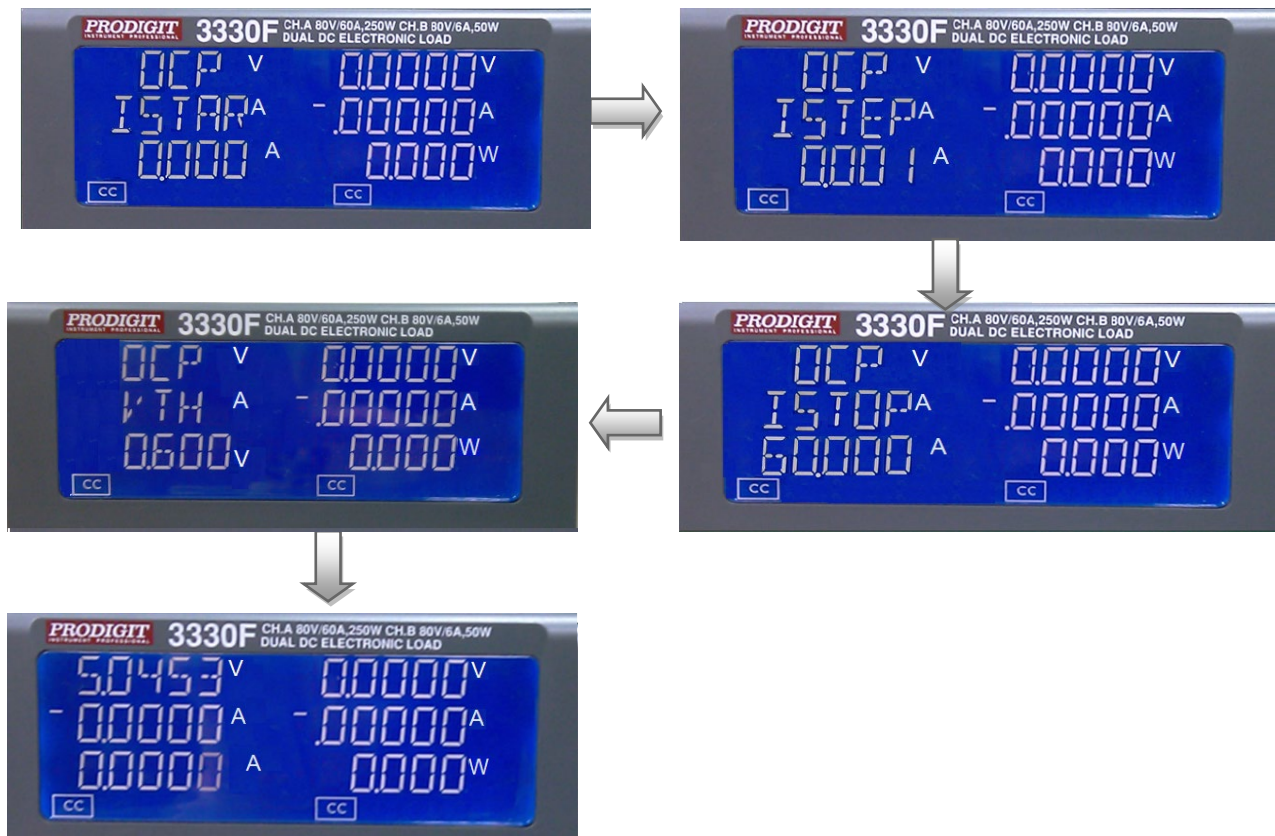

- ISTAR: setting the start current point, The LCD display shows 「OCP」 on upper 5 digit LCD display, Middle 5 digit LCD display 「ISTAR」, lower 5 digit LCD display setting value, the unit is "A".
The setting range is 0.000A to the full scale of the CC mode specification.
The setting is by rotating the setting knob.

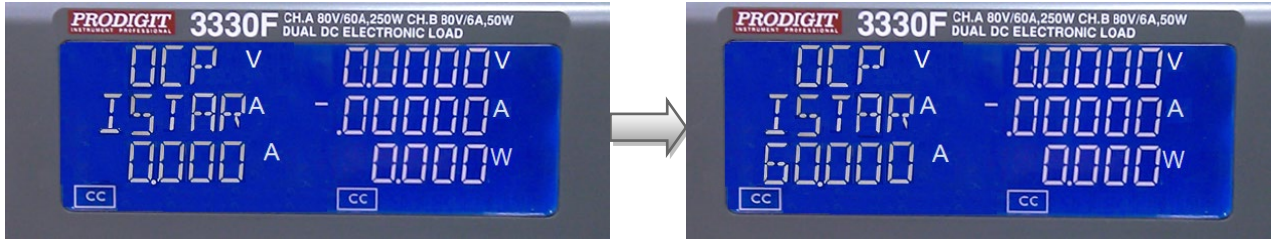

- ISTEP: setting the increment step current point, The LCD display shows 「OCP」 on upper 5 digit LCD display, Middle 5 digit LCD display 「ISTEP」, lower 5 digit LCD display setting value, the unit is "A".
The setting range is 0.000A to the full scale of the CC mode specification.
The setting is by rotating the setting knob.

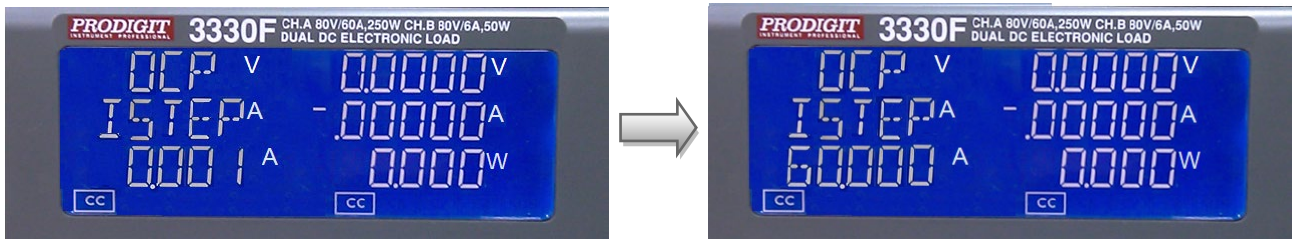

- ISTOP: setting the stop current point, The LCD display shows 「OCP」 on upper 5 digit LCD display, Middle 5 digit LCD display 「ISTOP」, lower 5 digit LCD display setting value, the unit is "A", the setting range is 0.000A to the full scale of the CC mode specification. The setting is by rotating the setting knob.

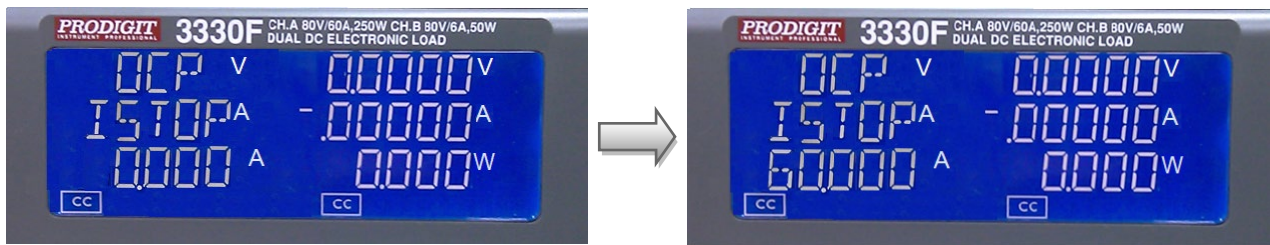

- Vth: Setting threshold voltage; The LCD display shows 「OCP」 on upper 5 digit LCD display, Middle 5 digit LCD display 「Vth」, lower 5 digit LCD display setting value, the unit is "V", the setting range is 0.000V to the full scale of the Voltage specification. The setting is by rotating the setting knob.

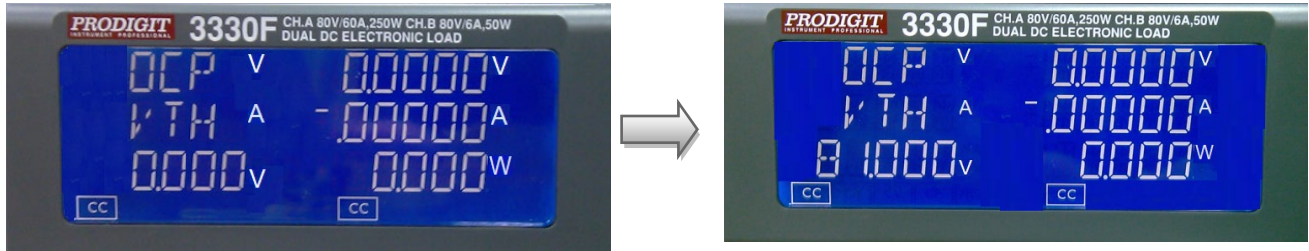

The OCP test function for test the UUT's over current protection, The OCP test will start sink current from I-START to increase ISTEP current until the UUT's output voltage drop-out lower than the threshold voltage (V-th setting), and the OCP trip point is between I_Hi and I_Lo limitation, then lower 5 digits LCD display will shows "PASS", otherwise shows "FAIL".

Press any key to goes to normal mode of LCD display.

3.1.20. **OPP** key and LED

- OPP test function Enable/Disable Key.
Press **OPP** key to enable the OPP test function and the indicator LED is lit on. The LCD display show 「OPP」 on upper 5 digits LCD display, shows 「PRESS」 on middle 5 digits LCD display and shows "START" on lower 5 digits LCD display.



- OPP test function parameter setting key.
There are 4 parameter for the OPP test function. The parameter as Pstar, Pstep, Pstop and Vth.

Press "OPP" key again to set OPP test parameter PSTAR(start power point) When OPP test function is enabled. Press OPP key again to next parameter by the sequence of PSTEP, PSTOP, Vth and disable, press another key also can to exit the setting and save the setting. The OPP test parameter description as following.

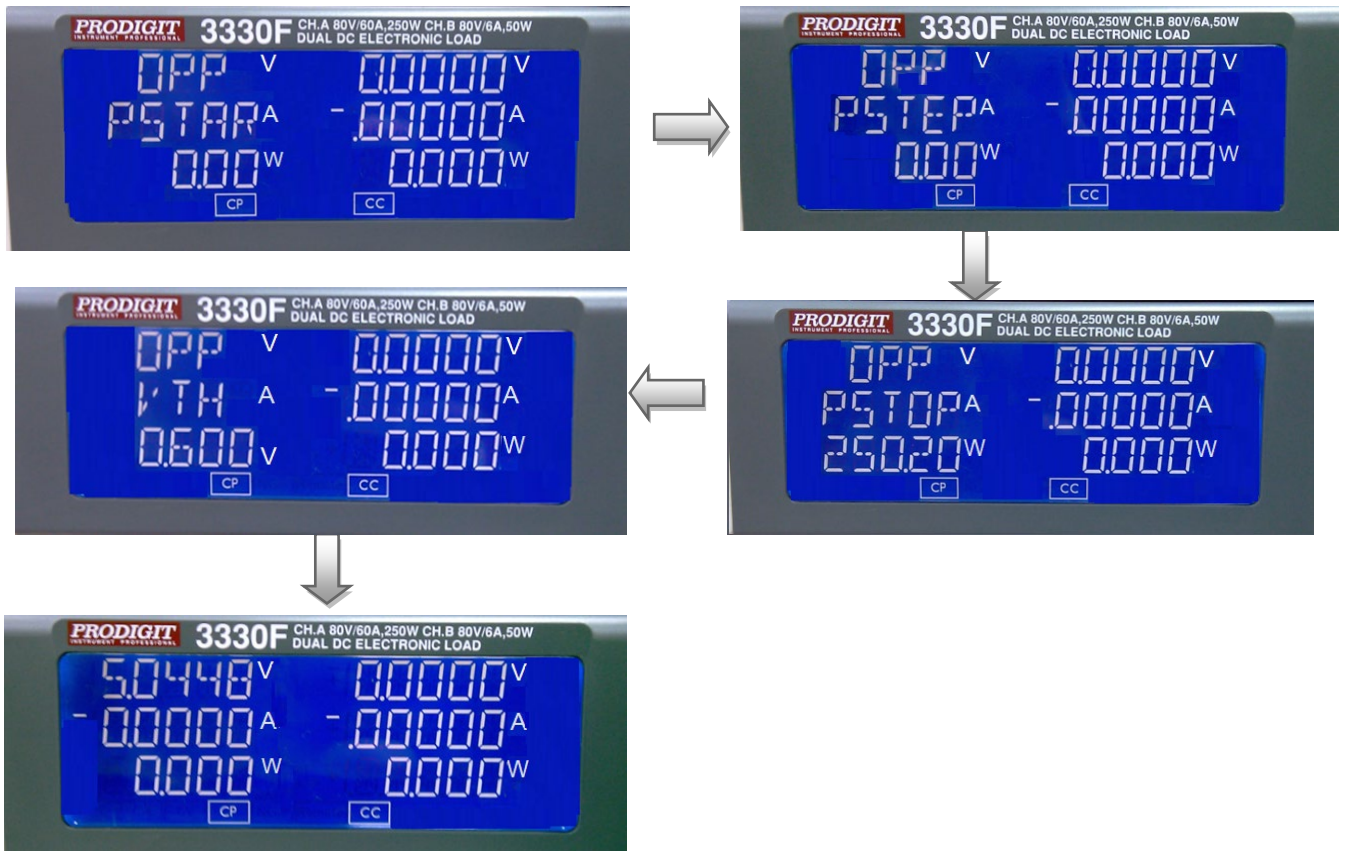

- **PSTAR**: setting the start power, The LCD display shows 「OPP」 on upper 5 digit LCD display, Middle 5 digit LCD display 「PSTAR」, lower 5 digit LCD display setting value, the unit is "W", the setting range is 0.00W to the full scale of the CP mode specification. The setting is by rotating the setting knob.

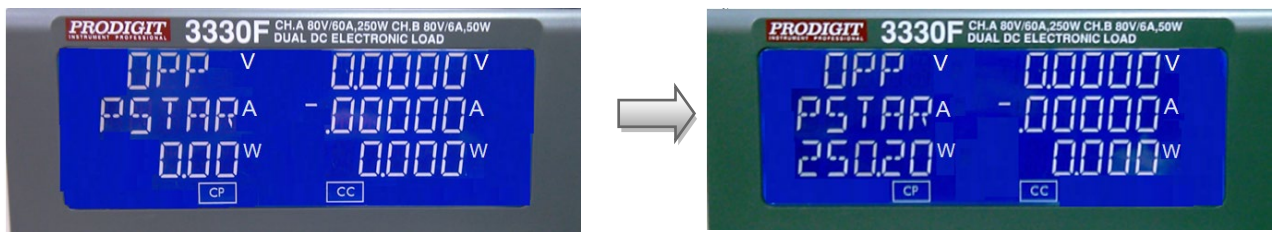

- **PSTEP**: setting the increment step power, The LCD display shows 「OPP」 on upper 5 digit LCD display, Middle 5 digit LCD display 「PSTEP」, lower 5 digit LCD display setting value, the unit is "W", the setting range is 0.00W to the full scale of the CP mode specification. The setting is by rotating the setting knob.

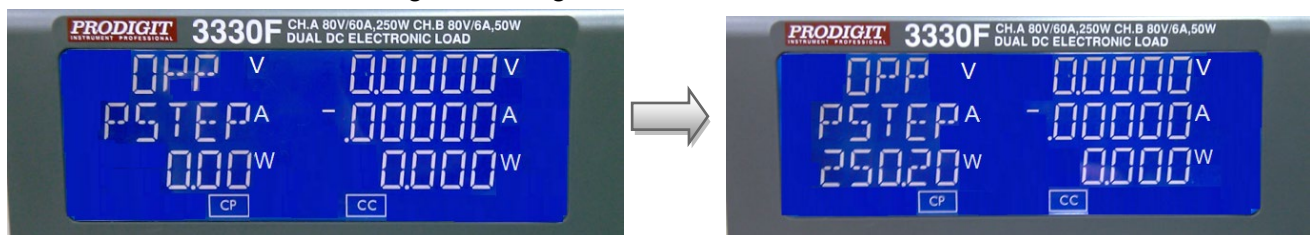

- PSTOP: setting the stop power, The LCD display shows 「OPP」 on upper 5 digit LCD display, Middle 5 digit LCD display 「PSTOP」, lower 5 digit LCD display setting value, the unit is "W", the setting range is 0.00W to the full scale of the CP mode specification. The setting is by rotating the setting knob.

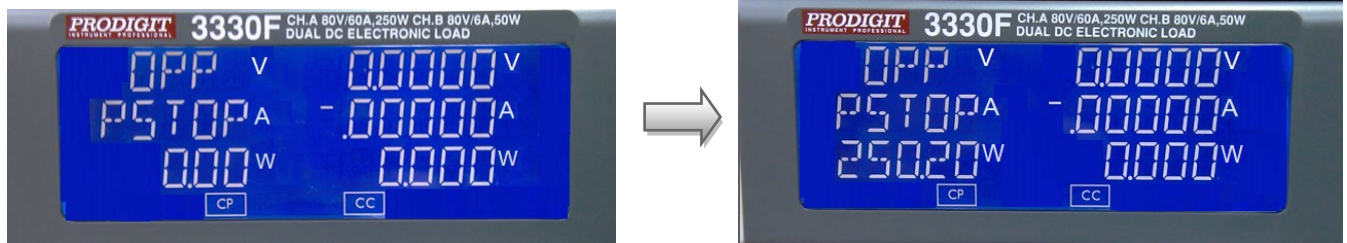

- Vth : Setting threshold voltage; The LCD display shows 「OPP」 on upper 5 digit LCD display, Middle 5 digit LCD display 「Vth」, lower 5 digit LCD display setting value, the unit is "V", the setting range is 0.000V to the full scale of the Voltage specification. The setting is by rotating the setting knob.

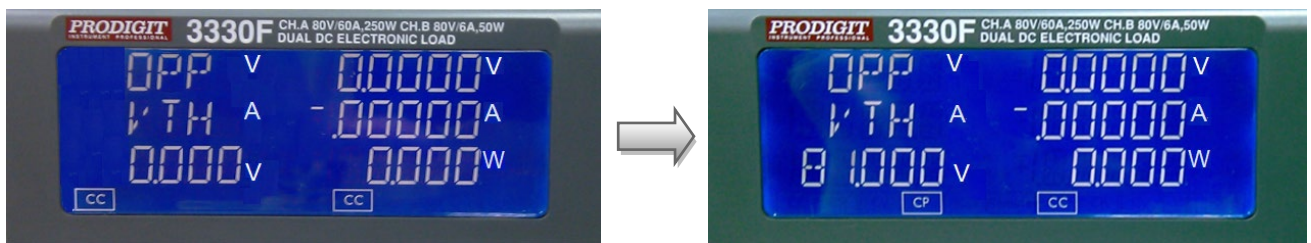

- START/STOP Test key.
Press START/STOP key to start or stop the OPP test by OPP test setting parameter when OPP test function is enabled.

The Load will goes to "ON" automatically when press START/STOP key to start the OPP test and the Load will goes to "OFF" automatically when press START/STOP key to stop the OPP test. The Load will stay to "ON" If load was "ON" before OPP test.

The OPP test function for test the UUT's over power protection, The OPP test will start sink current from PSTART to increase PSTEP current until the UUT's output voltage drop-out lower than the threshold voltage (V-th setting), and the OPP trip point is between W_Hi and W_Lo limitation, then lower 5 digits LCD display will shows "PASS", otherwise shows "FAIL".

Press any key to goes to normal mode of LCD display.

3.1.21. key

- Press START/STOP key to start or stop the short test by SHORT · OCP & OPP test setting parameter when SHORT · OCP & OPP test function is enabled.
- The Load will goes to "ON" automatically when press START/STOP key to Start the short test and the Load will goes to "OFF" automatically when press START/STOP key to stop the short test. The Load will stay to "ON" If load was "ON" before short test.
- The SHORT · OCP & OPP test function for test the UUT's short protection,

The SHORT · OCP & OPP test will sink load's full scale current(3330F 60A) until to fit in with the test condition, and the UUT's drop voltage is between V_{Hi} and V_{Lo} limitation, then lower 5 digits LCD display will shows "PASS", otherwise shows "FAIL".

NOTE: That will be goes to OFF automatically when press any key in the OCP,OPP,SHORT test process."

3.1.22. Knob and Knob key

- Right Knob: Setting digit can flash clockwise add setting value.

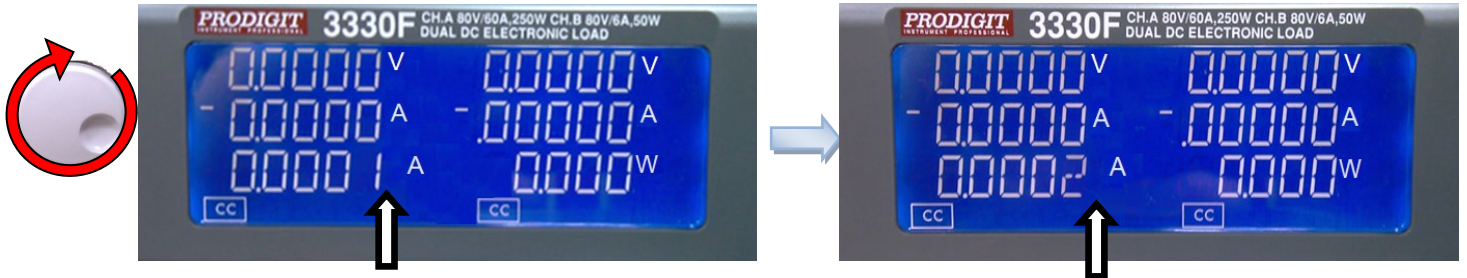

- Left Knob: Setting digit can flash Anti-clockwise to decrease setting value.

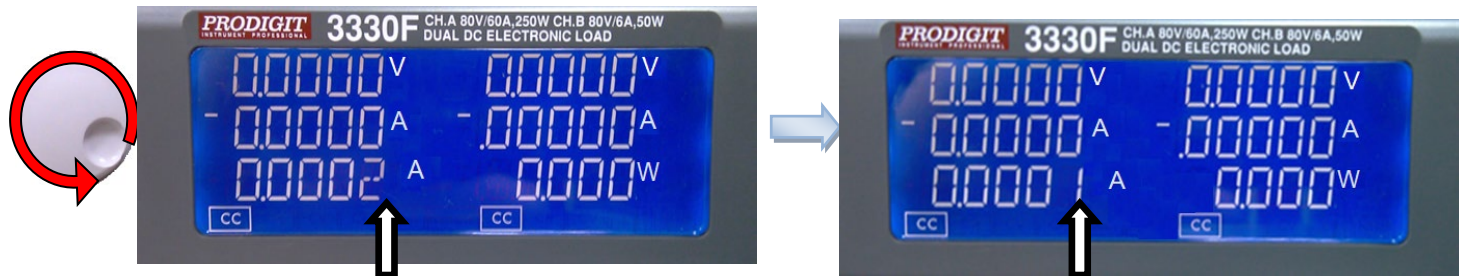

- Knob Left key: Setting digit can flash Left Knob key to push down setting value move left one-digit.



- Knob Right key: Setting digit can flash Knob Right key to push down setting value move Right one-digit.

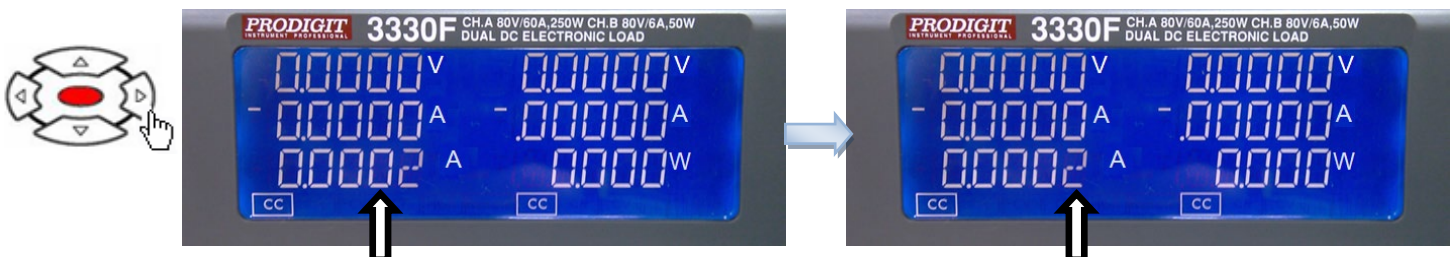

- Knob up key: Setting digit can flash Knob UP KEY to push down add setting

value.

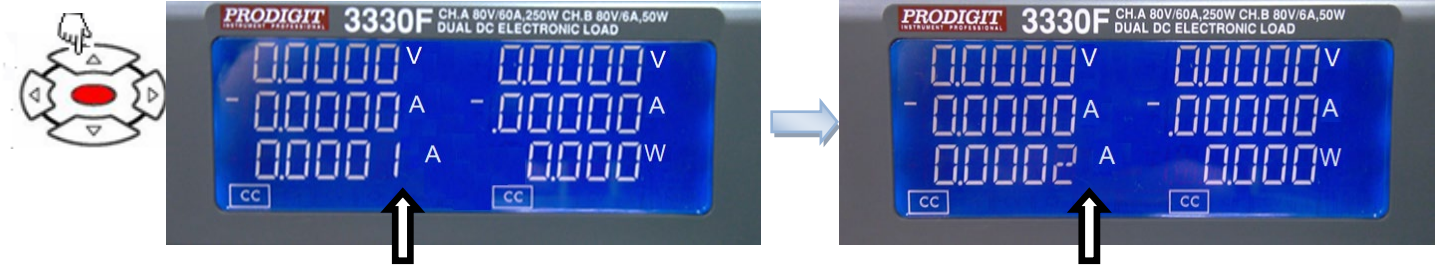

- Knob down key: Setting digit can flash Knob down key to push down to decrease setting value.

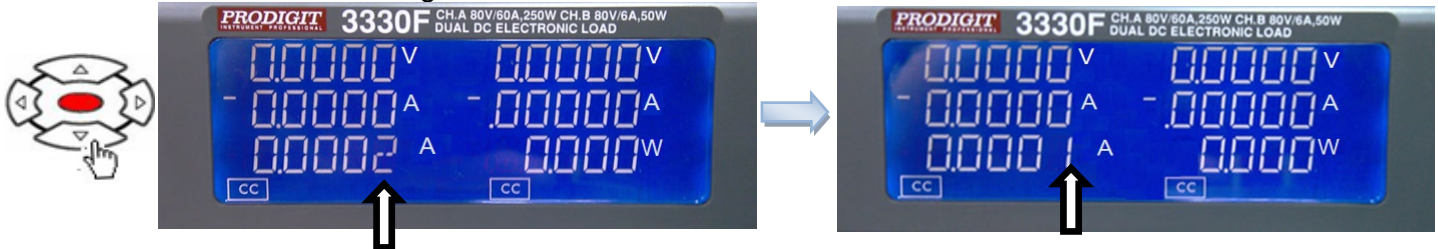

NOTE: ON CR MODE Right Knob and Knob UP KEY to push down decrease setting value.

ON CR MODE LEFT Knob DOWN KEY to push down add setting value.

3.1.23. +/- DC INPUT Terminal.

The positive and negative terminal of load input connector, it should connect to the positive and ground output for a positive output power supply, or the ground and negative output for a negative output power supply respectively.

Please take care of the voltage and current rating not to exceed the maximum rating of each 3330F series load module. Please check the polarity of DC input connection also before testing.

3.1.24. V-sense input terminal

To measure the specific voltage points through the V-sense input terminal, refer Fig 3-2 for detail application information.

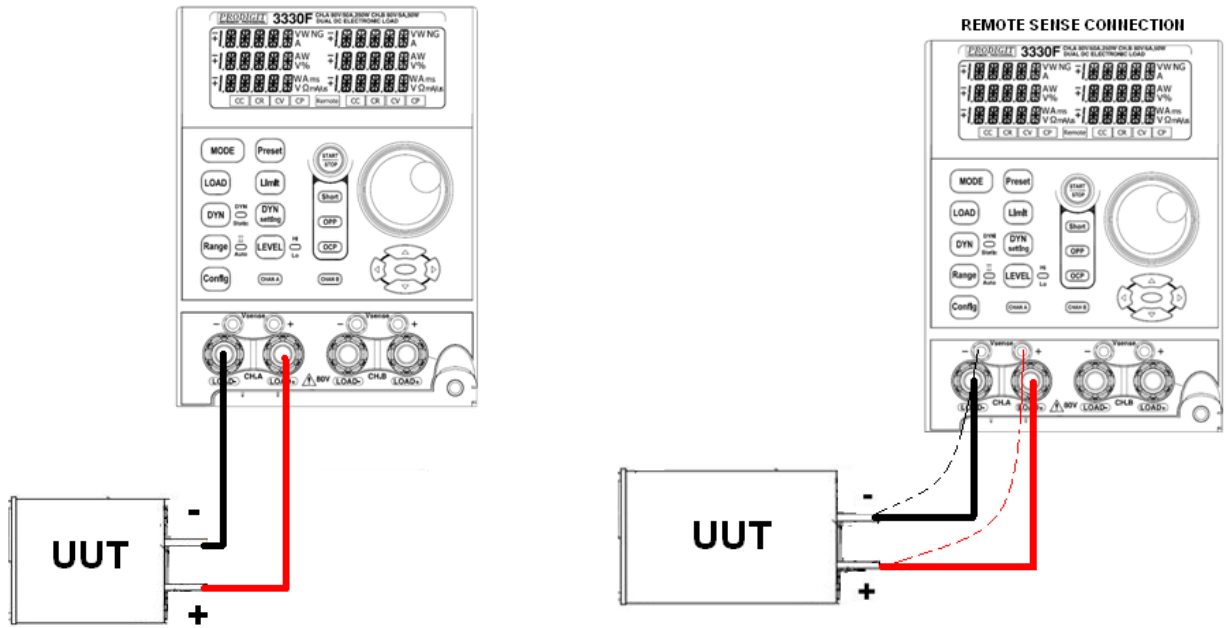
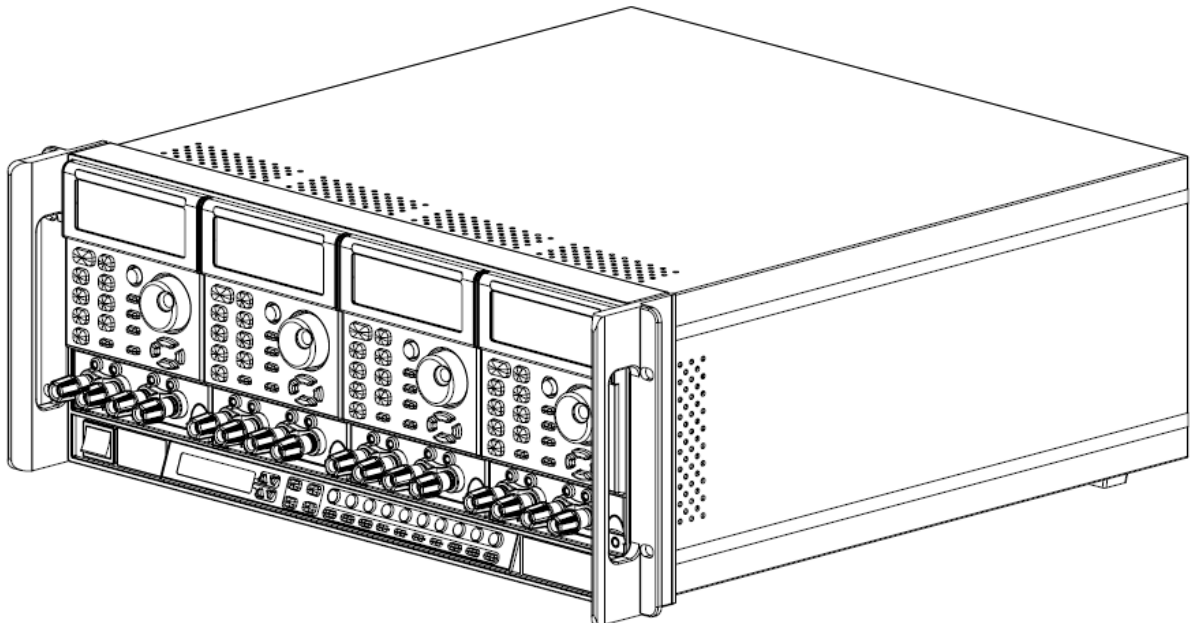
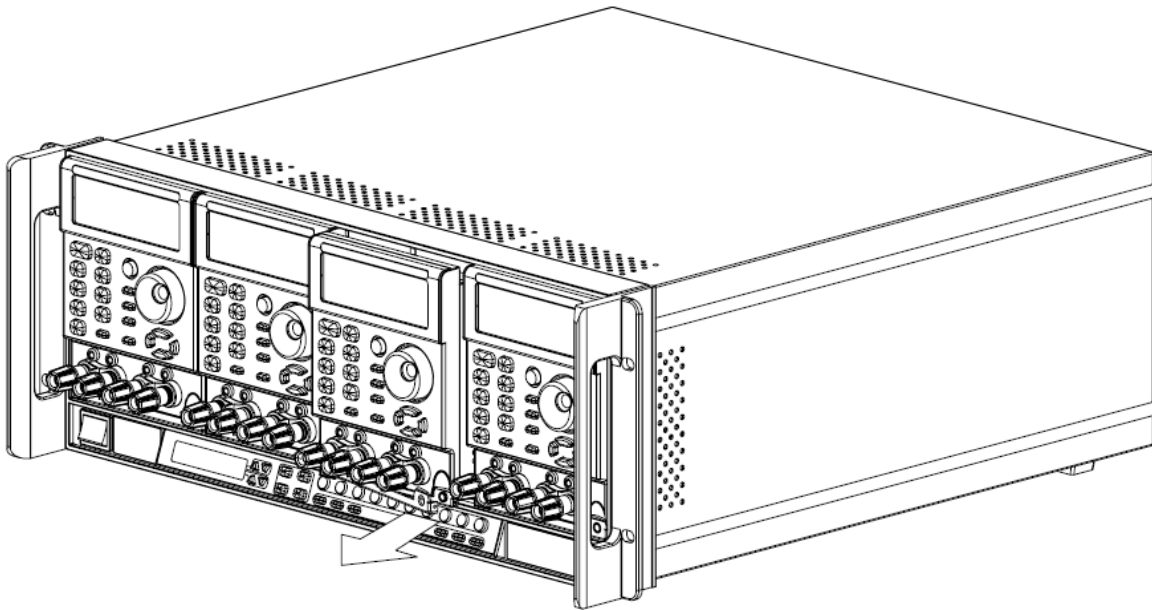

Fig 3-2 typical connection of 3330F series load module

3.1.25. The withdraw handle

When you want to remove the 3330F series load module out from the 3300F/3302F/3305F mainframe for configuration reconfiguration purpose, please follow the procedures which are listed below.





3-2 Initial setting of 3330F series load module

Tables 3-1 to 3-4 were described 3330F series electronic load module's initialization parameters.

Item	Initial value	Item	Initial value
CC L+Preset	0.0000 A	LIMIT	V_Hi 81.000 V
CC H+Preset	0.0000 A		V_Lo 0.000 V
CR H+Preset	80100 Ω		I_Hi 60.000 A
CR L+Preset	80100 Ω		I_Lo 0.000 A
CV H+Preset	81.000 V		W_Hi 250.20 W
CV L+Preset	81.000 V		W_Lo 0.00 W
CP L+Preset	0.000W		CONFIG
CP H+Preset	0.000W	LD-ON 1.0 V	
DYN	T HI 0.050 mS	LD-OFF 0.500 V	
	T LO 0.050 mS	POLAR+LOAD	
	RISE 250mA/uS	SHORT Disable	
	FALL 250mA/uS	OPP Disable	
		OCP	Disable

Table 3-1 3330F CHA initialize

Item	Initial value	Item	Initial value
CC L+Preset	0.0000 A	LIMIT	V_Hi 81.000 V
CC H+Preset	0.0000 A		V_Lo 0.000 V
CR H+Preset	801000 Ω		I_Hi 6.000 A
CR L+Preset	801000Ω		I_Lo 0.000 A
CV H+Preset	81.000 V		W_Hi 50.40 W
CV L+Preset	81.000 V		W_Lo 0.00 W
CP L+Preset	0.000W		CONFIG
CP H+Preset	0.000W	LD-ON 1.0 V	
DYN	T HI 0.050ms	LD-OFF 0.500 V	
	T LO 0.050ms	POLAR+LOAD	
	RISE 25mA/us	SHORT Disable	
	FALL 25mA/us	OPP Disable	
		OCP	Disable

Table 3-2 3330F CHB initialize

Item	Initial value	Item	Initial value		
CC L+Preset	0.0000 A	LIMIT	V_Hi	81.000 V	
CC H+Preset	0.0000 A		V_Lo	0.000 V	
CR H+Preset	199980 Ω		I_Hi	60.000 A	
CR L+Preset	199980Ω		I_Lo	0.000 A	
CV H+Preset	81.000 V		W_Hi	120.00 W	
CV L+Preset	81.000 V		W_Lo	0.00 W	
CP L+Preset	0.000W	CONFIG	SENSE	Auto	
CP H+Preset	0.000W		LD-ON	1.0 V	
DYN	T HI		0.050ms	LD-OFF	0.500 V
	T LO		0.050ms	POLAR+LOAD	
	RISE	100mA/us	SHORT	Disable	
	FALL	100mA/us	OPP	Disable	
			OCP	Disable	

Table 3-3 3332F CHA & CHB initialize

Item	Initial value	Item	Initial value		
CC L+Preset	0.0000 A	LIMIT	V_Hi	81.000 V	
CC H+Preset	0.0000 A		V_Lo	0.000 V	
CR H+Preset	1602000 Ω		I_Hi	3.000 A	
CR L+Preset	1602000Ω		I_Lo	0.000 A	
CV H+Preset	81.000 V		W_Hi	40.20 W	
CV L+Preset	81.000 V		W_Lo	0.00 W	
CP L+Preset	0.000W	CONFIG	SENSE	Auto	
CP H+Preset	0.000W		LD-ON	1.0 V	
DYN	T HI		0.050ms	LD-OFF	0.500 V
	T LO		0.050ms	POLAR+LOAD	
	RISE	12.5mA/us	SHORT	Disable	
	FALL	12.5mA/us	OPP	Disable	
			OCP	Disable	

Table 3-4 3336F CHA & CHB initialize

Item	Initial value	Item	Initial value		
CC L+Preset	0.0000 A	LIMIT	V_Hi	81.000 V	
CC H+Preset	0.0000 A		V_Lo	0.000 V	
CR H+Preset	159600Ω		I_Hi	30.000 A	
CR L+Preset	159600Ω		I_Lo	0.000 A	
CV H+Preset	81.000V		W_Hi	150.000 W	
CV L+Preset	81.000V		W_Lo	0.000 W	
CP L+Preset	0.000W	CONFIG	SENSE	Auto	
CP H+Preset	0.000W		LD-ON	1.0 V	
DYN	T HI		0.050ms	LD-OFF	0.500 V
	T LO		0.050ms	POLAR+LOAD	
	RISE	125.0mA/us	SHORT	Disable	
	FALL	125.0mA/us	OPP	Disable	
			OCP	Disable	

Table 3-5 3337F CHA & CHB initialize

3-3 Input terminal and wire consideration

The five ways connect the input wires to the Electronic load the connection methods are made as follow:

- 3.3.1 Plug connectors: This is the most popular way to connect the input of electronic Load to the device under test. It is recommended the load current is less than 20A in this connection for the current rating of the plug is rated to 20A. The maximum wire gage AWG14 can be used in this application.
- 3.3.2 Spade terminals: The spade terminal provides a good contact to the binding post, It is recommended to use anytime. The maximum wire gage 10 can be used in this Application as show Fig3-3 and Table 3-6.
- 3.3.3 Insert the wire into the input terminal: This is the most convenient way to connect The load input and D.U.T. The maximum wire gage AWG14 can be used in this application.
- 3.3.4 Both plug connectors and spade terminals: It is recommended to use when input current is greater than 20A or long lead wires.
- 3.3.5 Both plug connectors and Insert the wire into the input terminal. It is recommended to use when input current is greater than 20A or long lead wires. A major consideration in making input connection is the wire size. The minimum wire size is required to prevent overheating and to maintain good regulation. It is recommended that the wires should be large enough to limit the voltage drop to less than 0.5V per lead.

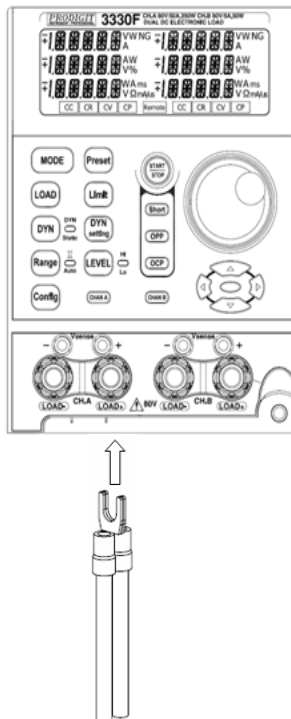

Fig 3-3 Hook Terminal Y type large size terminal connections

Wire Size AWG	Cross Section Area in mm²	Ampacity	Notes: Ratings for AWG-sized wires derived from MIL-W-5088B. Ratings for metric-sized wires derived from IEC Publication
22	0.75	5.0	Ampacity of aluminum wire is approximately 84% of that listed for copper wire.
20		8.33	
18	1	10	When two or more wires are bundled together, ampacity for each wire must be reduced to the following percentages:
16		15.4	
14	1.5	13.5	2 conductors 94% 3 conductors 89% 4 conductors 83% 5 conductors 76%
12		16	
10	2.5	31.2	4. Maximum temperatures: Ambient = 50° C Conductor = 105° C
8		25	
6	4	40	
4		32	
	6	55	
		40	
	10	75	
		63	
		100	
		135	

Table 3-6 Stranded Copper Wire Ampere Capacity

3-4 . Protection features

The 3330F series Electronic load modules include the following protection features:

- 3.4.1. Voltage
- 3.4.2. Over current
- 3.4.3. Over power
- 3.4.4. Over temperature
- 3.4.5. Reverse Polarity

The Over voltage protection circuit is set at a predetermined voltage (84V for 3330F, 3332F, 3336F) which cannot be changed. If the Over voltage circuit has tripped, it Electronic load input turns OFF immediately to protect the abnormal condition.

When the Over voltage condition is occurred, the Digital Current Meter's seven segment LED display will indicate " oVP ".

CAUTION : Never apply the AC line voltage or input voltage excised than 80V, or it may cause damage of the electronic load module.

The 3330F series Electronic load can monitor the power dissipation of the load module, when the power dissipation is greater than 105% of rate power input, the load module will turn load to OFF state internally.

When the Over power condition is occurred, the Digital Current Meter's seven segment LED display will indicate " oPP ".

As soon as the temperature of 3330F series module's heat sink greater than 85 degree, the Over temperature protection is occurred, the Digital Current Meter's seven segment LED display will indicate " otP " at same time, the 3330F series Electronic Load will turn load to OFF state internally.

Please check the environment condition such as the ambient temperature and distance between the rear panel of Electronic load mainframe and wall is greater than 15cm.

The 3330F series Electronic load can reset the Over voltage, Over correct, Overpower and over temperature protection if the protection condition is removed and press the " LOAD " key to " ON " state.

The 3330F series electronic load conducts reverse current when the polarity of the DC source connection is incorrect. The maximum reverse current is 60A for 3330F CHA, 6A for 3330F CHB, 24A for 3332F CHA and CHB, 3A for 3336F CHA and CHB. If the reverse current excess the maximum reverse current, it may cause damage of the 3330F series Electronic Load.

When the reverse condition , the reverse current is displayed on the 5 digit Current Meter on the front panel, and the 5 digit DCM indicates negative current reading, whenever the reverse current is displayed on the current meter, turn OFF power to the DC source and make the correct connections.

Chapter 4 Applications

This chapter describes the application information of 3330F series Electronic Load module.

4-1 Local sense connections

Fig 4-1 illustrates a typical set up with the electronic load connected to the DC power supply.

Local sensing is used in application where lead lengths are relatively short, or where load regulation is not critical.

The 5 digit voltage Meter of 3330F series Electronic load measures the voltage of DC INPUT Terminal automatically; load leads should be bundled or tie-wrapped together to minimize inductance.

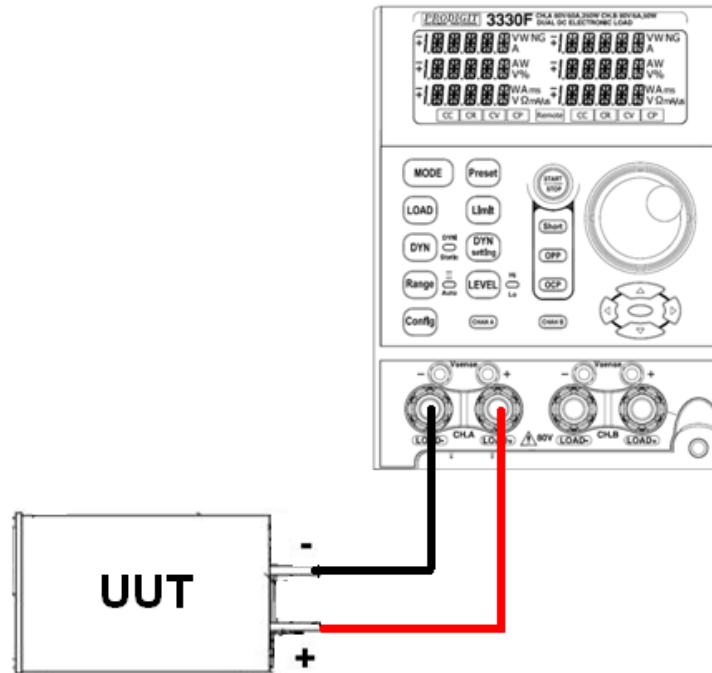

Fig 4-1 Local voltage sense connections

4-2 Remote sense connections

Fig 4-2 illustrates a typical set up with the electronic load connected for remote sense operation. The remote V-sense cables of the electronic load are connected to the output of the power supply. Remote sensing compensates for the voltage drop in applications that require long lead lengths.

The 5 digit voltage Meter of 3330F series Electronic load measures the voltage of V-sense input Terminal automatically, so the high accuracy 5 digit voltage Meter can measure the specific points voltage of the power supply's output voltage.

Load leads should be bundled or tie wrapped together to minimize inductance.

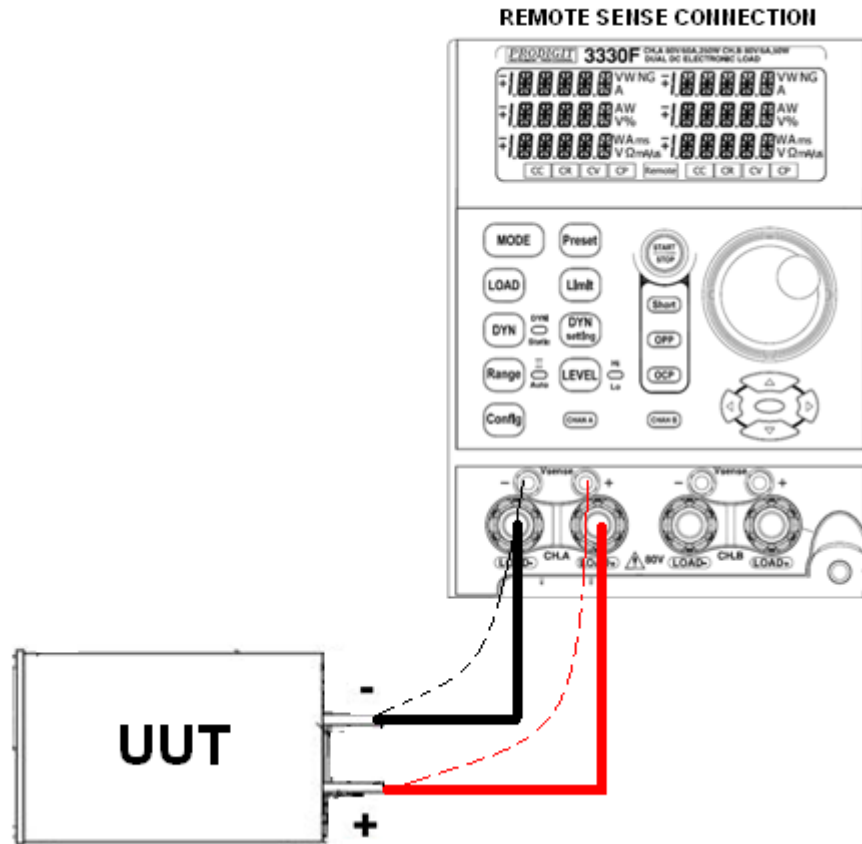

Fig 4-2 Remote voltage sense connections

4-3 Constant Current mode application

The Constant Current mode is very suitable to test the Load Regulation, Cross Regulation, Output Voltage and Dynamic Regulation of the power supply testing, and test the Discharge Characteristic and Life cycle of the Battery testing.

4.3.1 Static mode: (Fig 4-3)

Major application:

4.3.1.1 Source testing

4.3.1.2 Power supply load regulation testing

4.3.1.3 Battery discharge testing

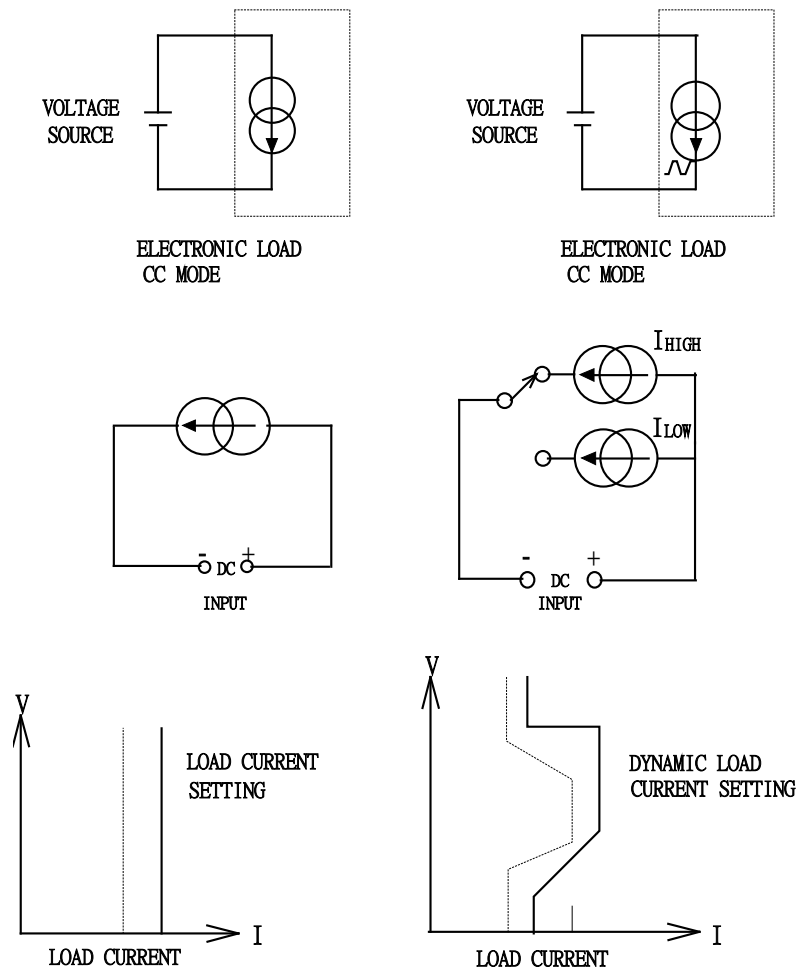

Fig 4-3 constant CURRENT mode application

4.3.2 Dynamic mode:

4.3.2.1 Built-in Pulse generator: (Fig 4-4)

Major application:

- 4.3.2.1.1 Power supply load transient response testing
- 4.3.2.1.2 Power recovery time testing
- 4.3.2.1.3 Pulse load simulation
- 4.3.2.1.4 Power component testing

Description:

The maximum Rise/Fall current slew rate or minimum Rise/fall time is the time required for the load input to change from 10% to 90% or from 90% to 10% of the programmed High to Low load level.

$$\text{Rise slew rate} = |I_{\text{low}} - I_{\text{high}}| / T_a \text{ (A/us)}$$

$$\text{Fall slew rate} = (I_{\text{high}} - I_{\text{low}}) / T_b \text{ (A/us)}$$

$$\text{Rise time} = T_a = |I_{\text{low}} - I_{\text{high}}| / \text{Rise slew rate}$$

$$\text{Fall time} = T_b = (I_{\text{high}} - I_{\text{low}}) / \text{Fall slew rate}$$

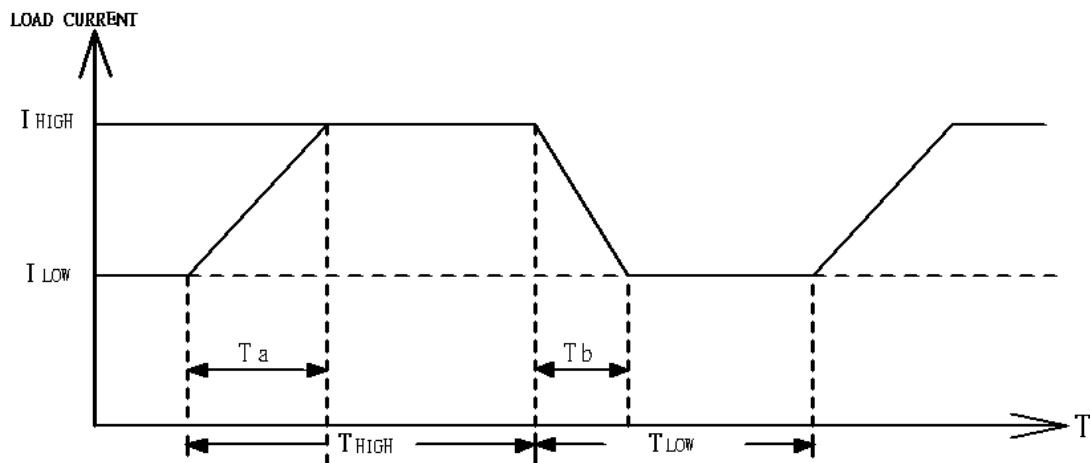

Fig 4-4 Dynamic load current with independent programmed Rise/Fall slew rate

4-4 Constant Voltage mode application

Major application:

4.4.1 Current source testing

The battery charger is a current source to charge current into a re-chargeable battery, the CV mode of electronic load can be used to simulate the terminal voltage of re-chargeable battery, it is designed to test the charge current from battery charger.

The Battery charger of notebook PC and Mobile phone is the most popular products for the current source in the real world, user can use CV mode to set voltage say 6.0V (example), then read charge current from the current meter on the load, next then set CV voltage to 5V (example), then read the charge current again, this method is used to test the load regulation of a current source.

4.4.2 Power supply current limit characteristic testing

The current limit is a necessary function for a power supply; the Fold-back current limit curve is very common for a switching power supply, where the constant current limit curve is very popular for a lab power supply.

It is very difficult or impossible to find out the above current limit curve by CC or CR mode, however, it becomes easy by using CV mode. User can set CV voltage, record the output current, then makes a series voltage and current to result a output current limit curve (Figure 4-5) of a power supply.

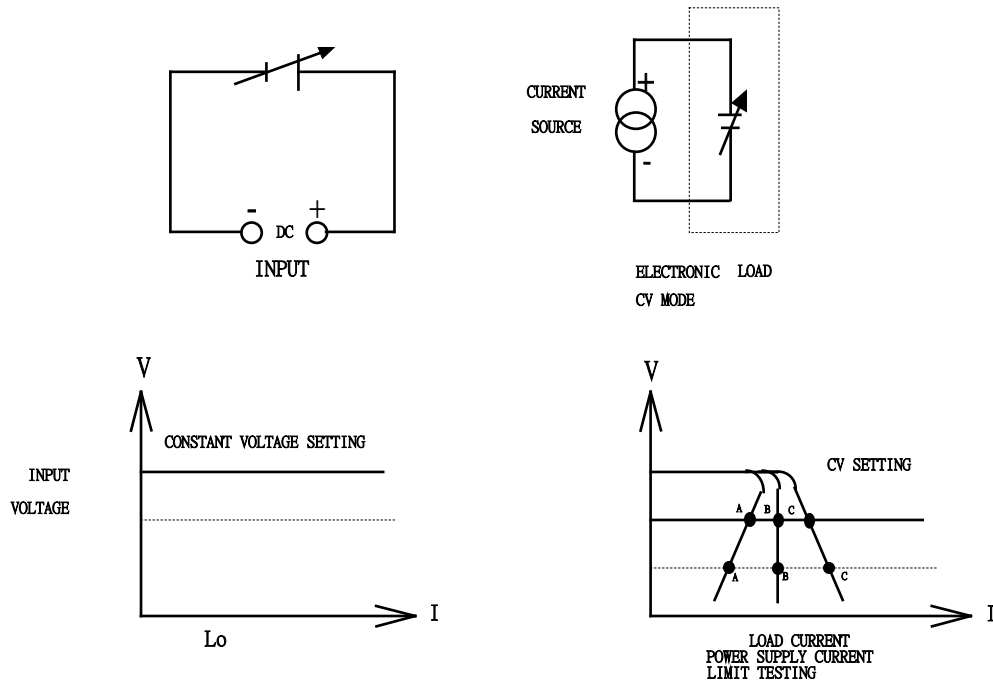

Fig 4-5 Constant Voltage mode application

4-5 Constant Resistance mode application

Major application:

4.5.1 Voltage source or Current source testing

4.5.2 Power supply power-up sequence

The constant current and constant resistance modes are used in conjunction for testing switching power supplies.

Caution must be exercised when using the CC mode in test set up, for example: A 5V/50A output power supply cannot deliver 50A over its start up range 0-5 volts. In many cases the power supply short circuit or over current protection circuit will shut the power supply down. What is occurring is that the power supply is trying to deliver 50A at 2V because the load tester is in the CC mode. The power supply is designed not to do this.

As a result, when testing a power supply, the CR mode should be used to allow the power supply voltage and current to ramp up together. After this has occurred the CC mode should be used to complete testing.

It has eliminated the need for manually switching from the CR to the CC mode with 3330F series Electronic Loads. They can be programmed with proper current and slew rate in the CC mode which allows a power supply to reach its specified output condition in the CC load mode.

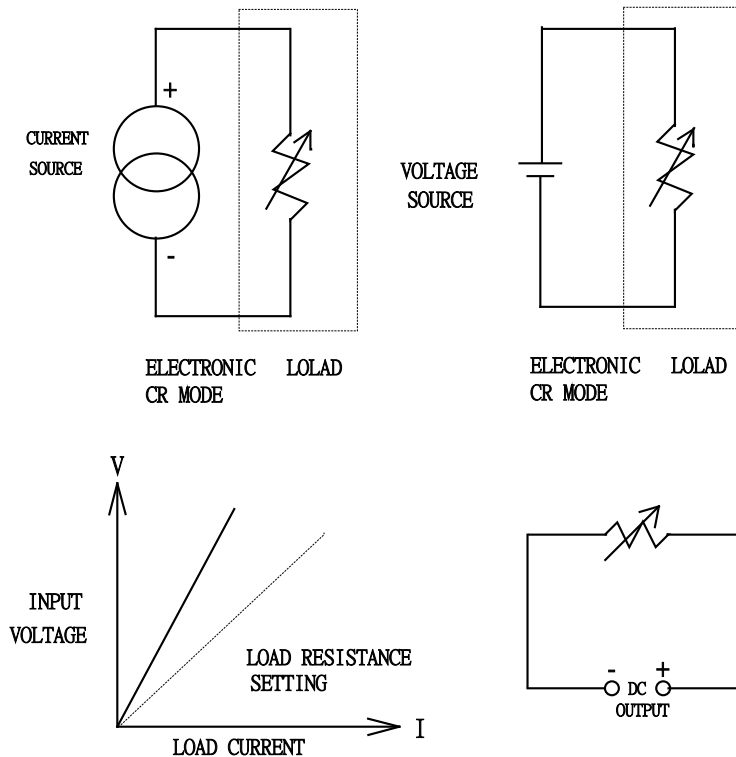

Fig 4-6 Constant Resistance mode Application

4-6 Constant Power mode application

The Constant Power mode is designed for Battery's energy capacity evaluation and testing.

Primary or secondary battery is the power source for every portable electronics products, such as notebook computer, video camera, etc. The output voltage of battery will start to drop (Fig 4-7a) according to the output current and usage duration time (Fig 4-7b), however, it should provide a stable power output regardless of output voltage (Fig 4-7c), therefore, the energy capacity (output power x time) is one of the most important factor to evaluate a battery.

The CP mode of 3330F series electronic load is designed to test the above characteristics of a battery, it can sink constant power load for a battery, the load current will increase automatically in accordance to the output voltage drop of battery, the load power will be the same to the load power setting of CP mode (Fig 4-7d), the 3330F series CP mode electronic load with time record can be used to evaluate the energy capacity or discharge life time of a battery.

Moreover, the real power could be a dynamic loading condition, the 3330F series CP mode can be operated in Dynamic power load as well, setting the STA/DYN to DYN on the front panel or remote programming, 3330F series can sink dynamic power waveform to test the dynamic characteristics of battery (Fig 4-7e).

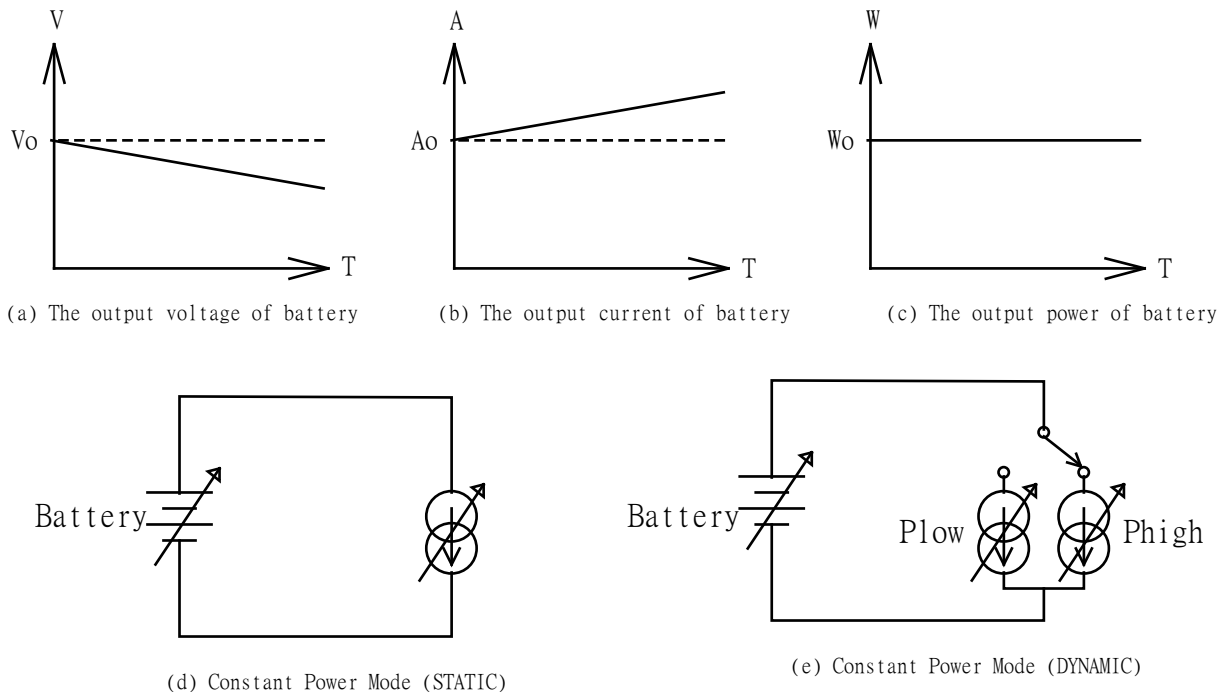

Fig 4-7 CONSTANT POWER MODE APPLICATION

4-7 Connection of a multiple output power supply

The following is a rule for a multiple output power supply connects to the 3330F series Electronic Loads.

Rule: The potential of positive input (Red binding post) must be higher than the potential of negative input (Black binding post) of 3330F series Electronic load.

Here is an example of +5V, -5V, +12V and -12V four outputs power supply connected to a 3330F series electronic load

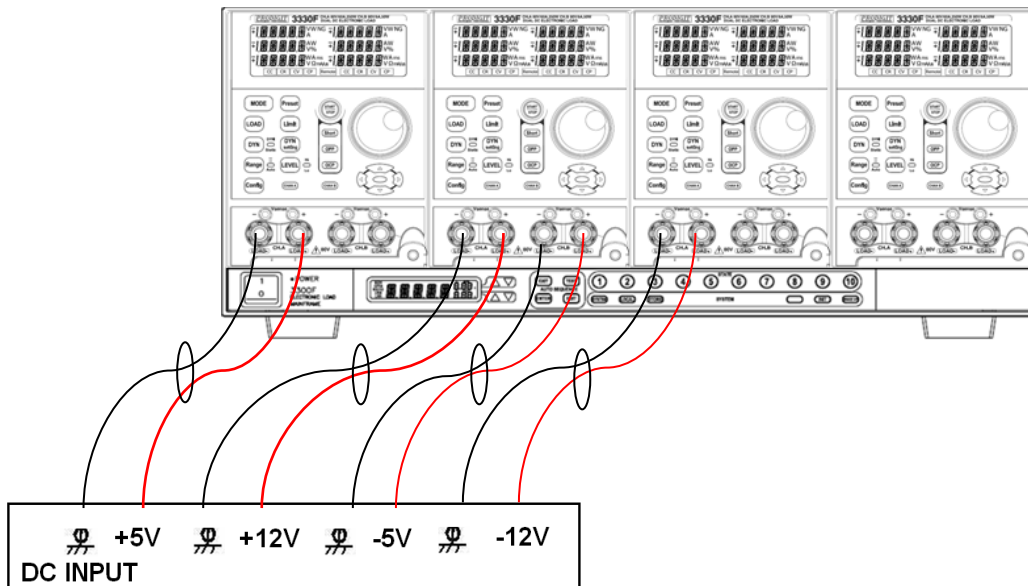

Fig 4-8 Connection between 3330F series plug-in load and multiple output power supply

4-8 Parallel operation

When the power or current rating is not enough on the electronic load module, up to eight modules in one mainframe can be directly paralleled in CC or in CR or in CP mode, modules cannot be paralleled in CV mode. At this time, the total load current and power is the sum of the two or more load modules also. This connection can extend the electronic load module to a higher power and current rating.

- Note: 1. the electronic load only may carry on the parallel operation under the fixed electric current pattern.
2. The electronic load do not use under series connection.

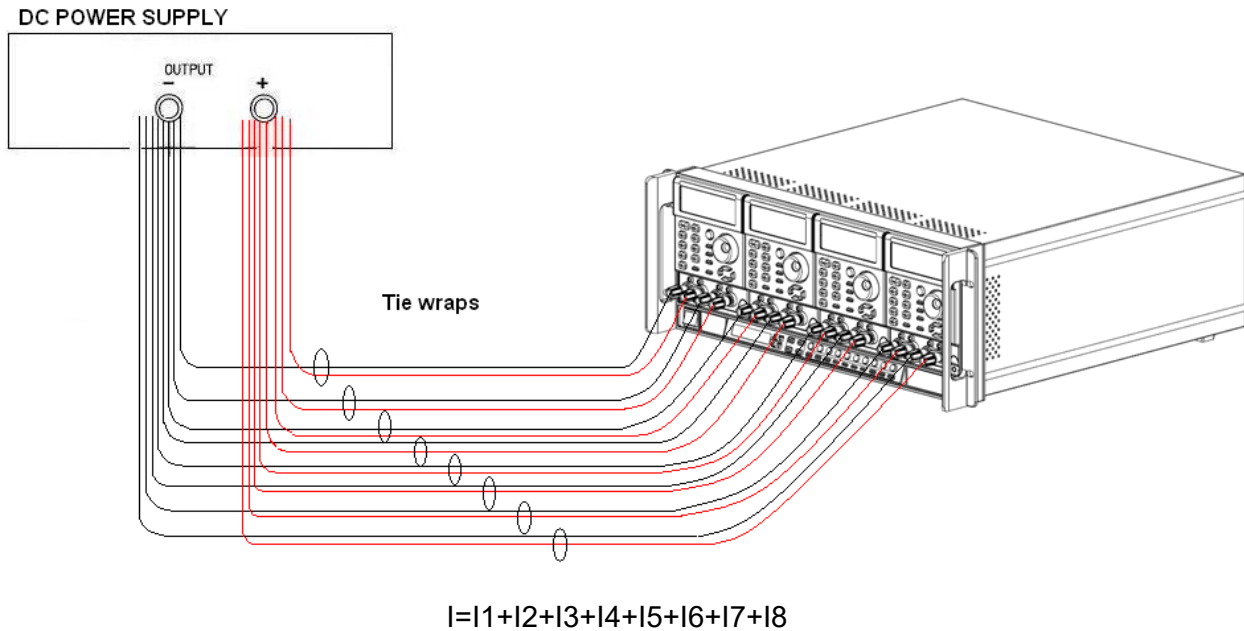

Fig 4-9 3330F series plug-in module parallel operation

4-9 Zero-Volt loading application

As shown in Fig 4-10, the Electronic load can be connected in series with a DC voltage source which output voltage greater than 2V-3V so that the device under test that are connected to the Electronic load can be operated down to a Zero- Volt condition, the DC voltage source provides the minimum 2V-3V operating voltage required by the Electronic load. This application is suitable for low voltage Battery cell with high discharge current testing.

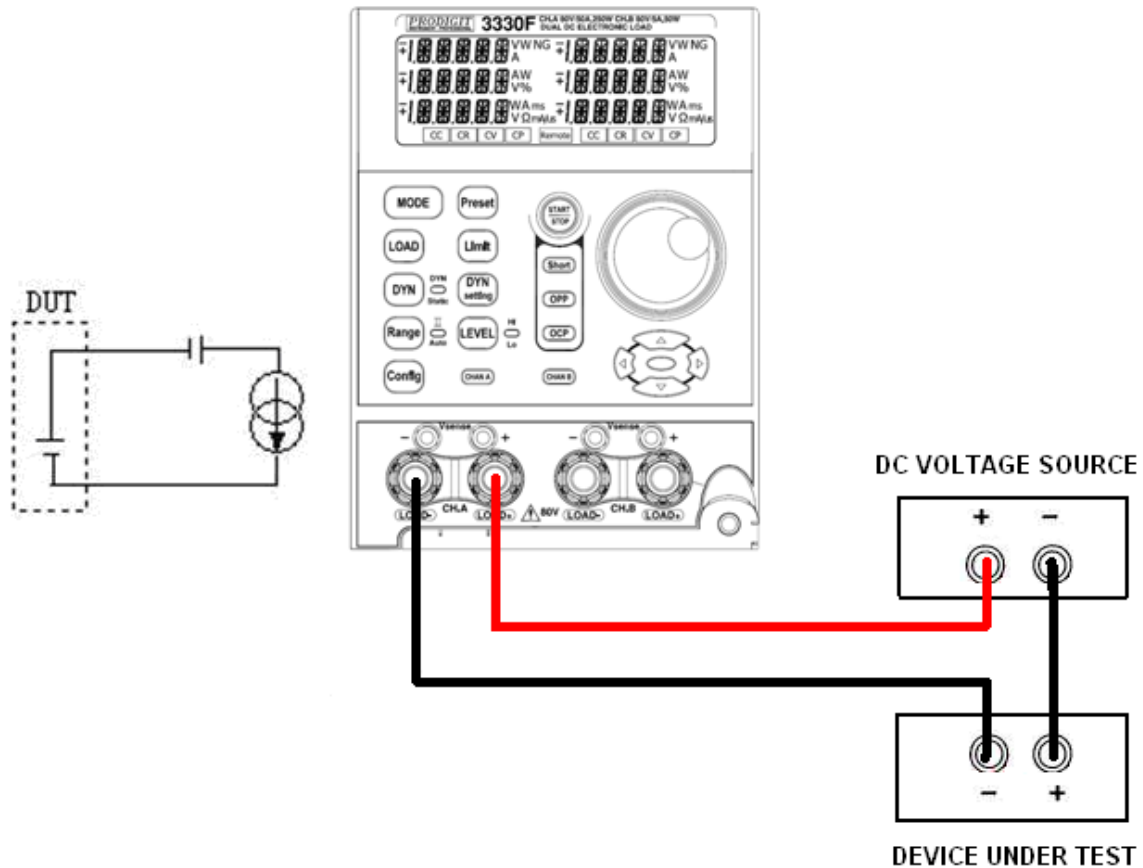
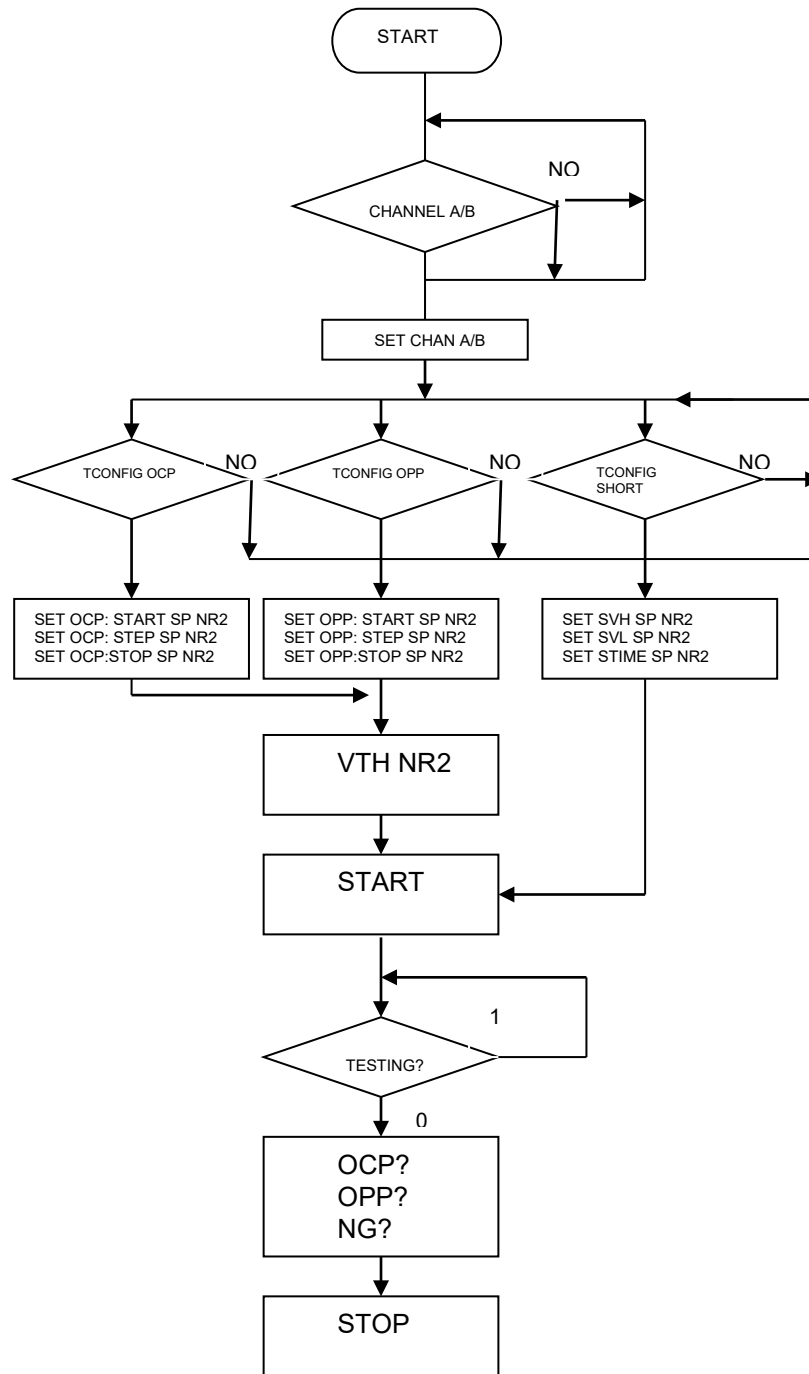

Fig 4-10 Zero-Volt loading connection

4-10 3330F series electronic load OCP, OPP, SHORT operation flow Chart



4-11 Power Supply OCP testing

- 4.11.1 There is a method for power supply Over Current Protection (OCP) testing: Power Supply OCP testing using CC mode method (active by memory recall operation only).
- 4.11.2 OCP test function Enable/Disable Key.
Press **OCP** key to enable the OCP test function and the indicator LED is lit on. The LCD display show "OCP" on upper 5 digits LCD display, shows "PRESS" on middle 5 digits LCD display and shows "START" on lower 5 digits LCD display.



- 4.11.3 There are 4 parameter for the OCP test function. The parameter as ISTAR, ISTEP, ISTOP and Vth.

Press "OCP" key again to set OCP test parameter **ISTAR**(start current point) When OCP test function is enabled. Press OCP key again to next parameter by the sequence of **ISTEP**, **ISTOP**, **Vth** and disable, press another key also can to exit the setting and save the setting. The OCP test parameter description as following.

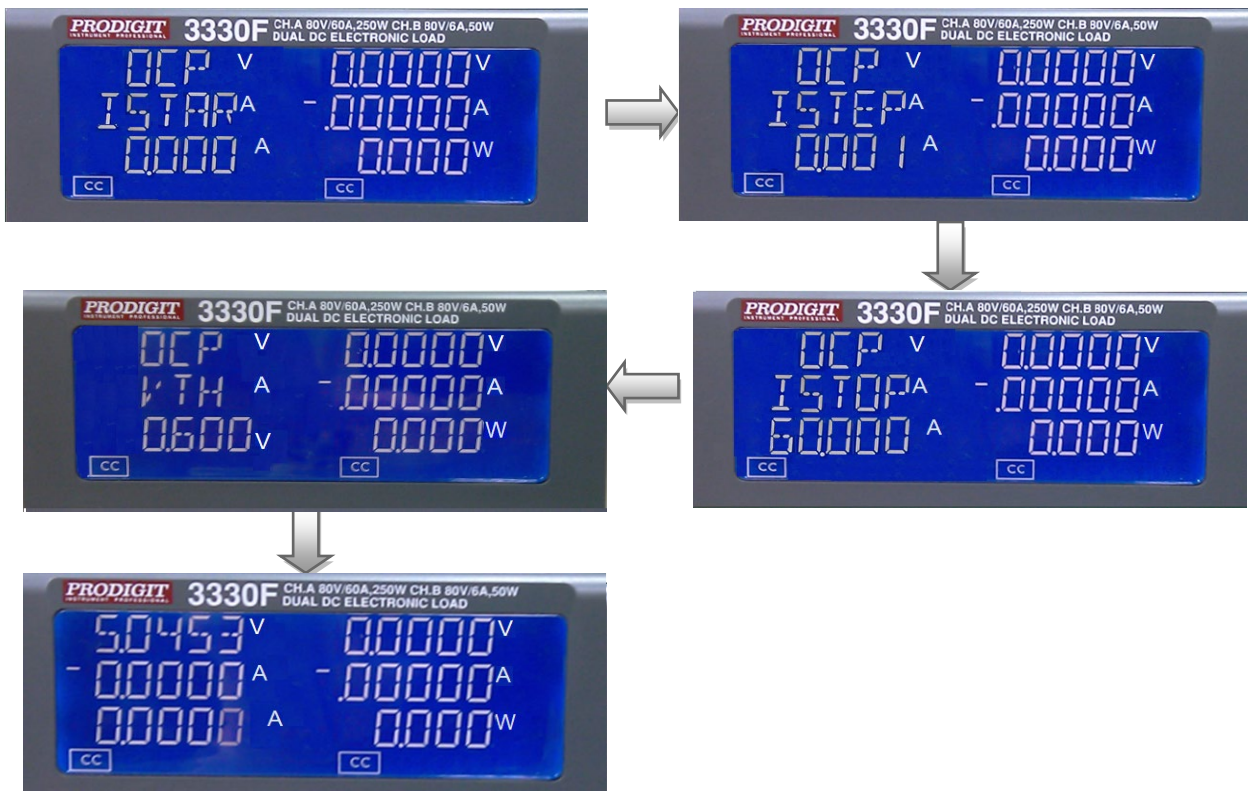

- 4.11.3.1 Istar : setting the start current point, The LCD display shows “OCP”, “ISTAR” and 0.000A (initial) from upper to lower 5 digits LCD display, the setting range is 0.000A to the full scale of the CC mode specification. The setting is by rotating the setting knob.

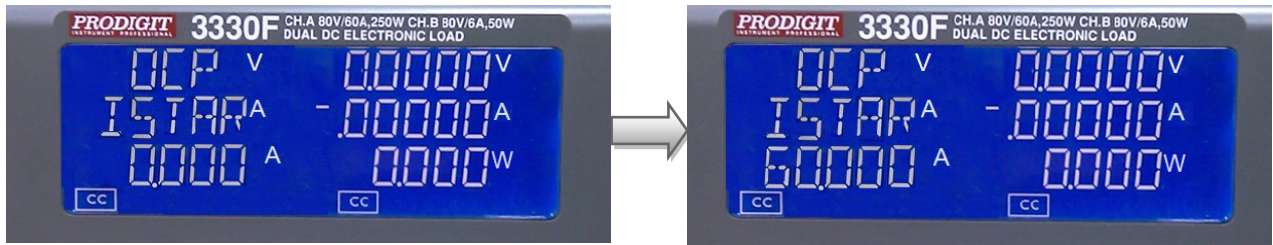

- 4.11.3.2 Istep : setting the increment step current point, The LCD display shows “OCP”, “ISTEP” and 0.000A (initial) from upper to lower 5 digits LCD display, the setting range is 0.000A to the full scale of the CC mode specification. The setting is by rotating the setting knob.

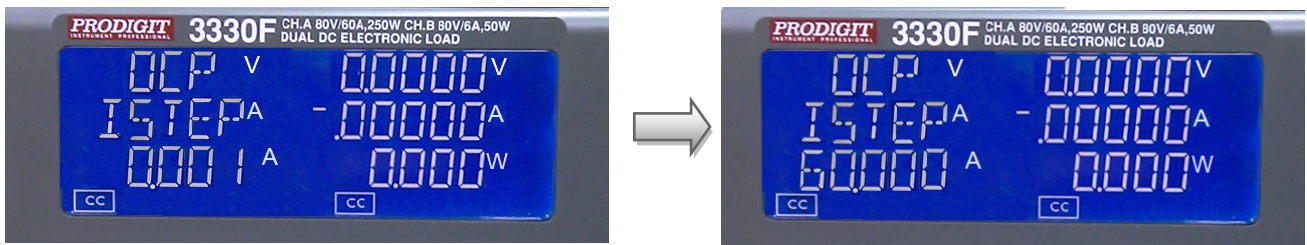

- 4.11.3.3 Istop : setting the stop current point, The LCD display shows “OCP”, “ISTOP” and 60.000A (3330F CHA initial) from upper to lower 5 digits LCD display, the setting range is 0.000A to the full scale of the CC mode specification. The setting is by rotating the setting knob.

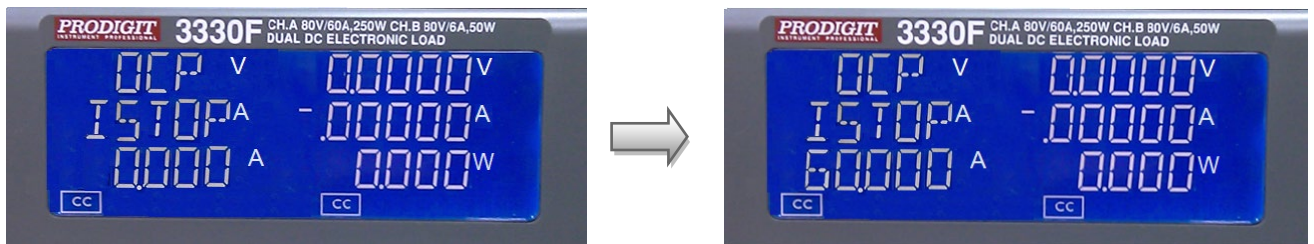

- 4.11.3.4 Vth : Setting threshold voltage; The LCD display shows “OCP”, “Vth” and 0.600V (3330F CHA initial) from upper to lower 5 digits LCD display, the setting range is 0.000V to the full scale of the Voltage specification. The setting is by rotating the setting knob.

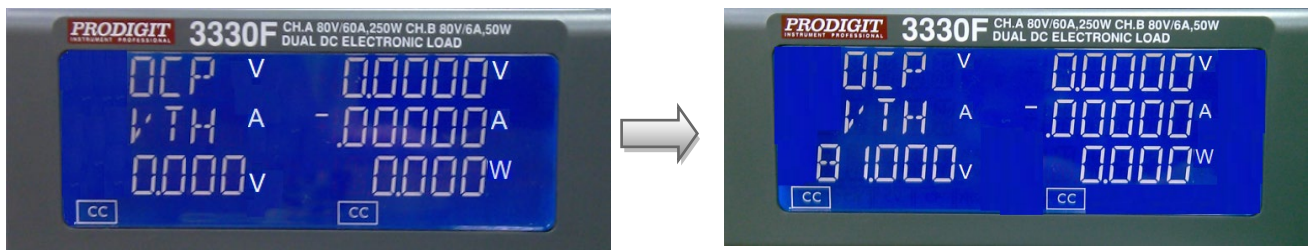

4.11.4 START/STOP Test key.

Press START/STOP key to start or stop the OCP test by OCP test setting Parameter when OCP test function is enabled.

The Load will go to "ON" automatically when press START/STOP key to start the OCP test and the Load will go to "OFF" automatically when press START/STOP key to stop the OCP test. The Load will stay to "ON" if load was "ON" before OCP test.

The OCP test function for test the UUT's over current protection, The OCP test will start sink current from I-START to increase I-STEP current until the UUT's output voltage drop-out lower than the threshold voltage (V-th setting), and the OCP trip point is between I_Hi and I_Lo limitation, then middle 5 digits LCD display will show "PASS", otherwise shows "FAIL".

Press any key to go to normal mode of LCD display.

4.11.5 OCP Manual control

Example:

4.11.5.1. Setting OCP test, press OPP key to the next step.



4.11.5.2. Setting start load current 0A, press OPP key to the next step.



4.11.5.3. Setting step load current 0.001A, press OPP key to the next step.



4.11.5.4. Setting stop load current 0.65A, press OPP key to the next step.



4.11.5.5. Setting OCP VTH 0.6V, press OPP key to the next step.



4.11.5.6. Press START/STOP test key.

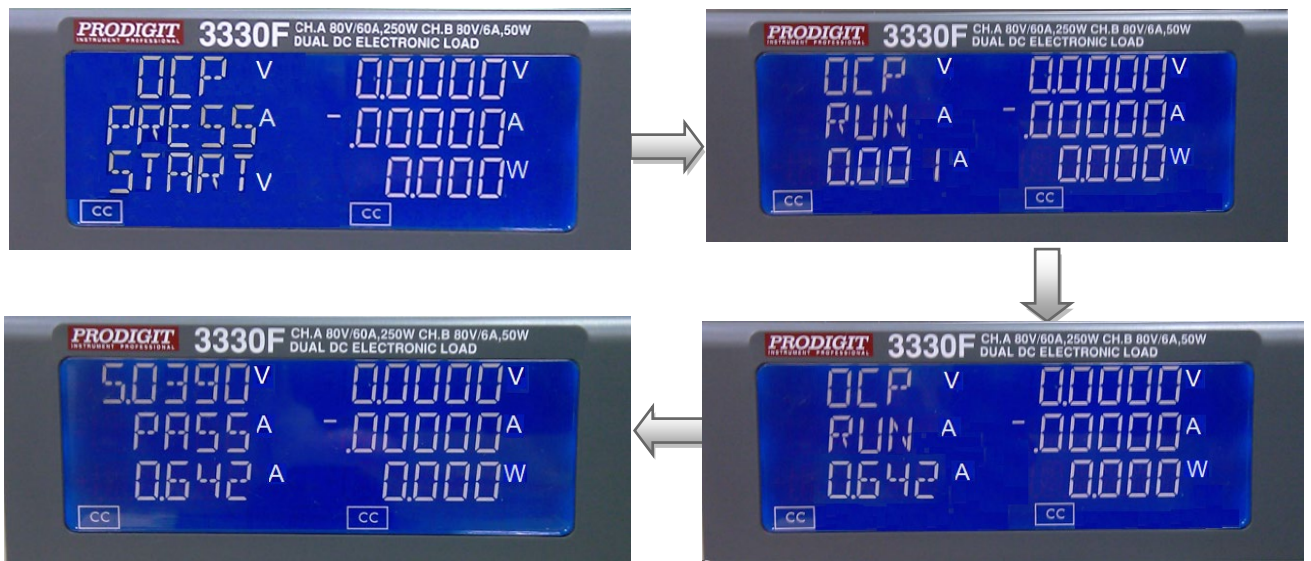

- 4.11.5.7. the UUT's output voltage drop-out lower than the threshold voltage(V_{th} setting), and the OCP trip point is between I_{Hi} and I_{Lo} limitation, then middle 5 digits LCD display will shows "PASS", otherwise shows "FAIL".



4.11.6 Remote control OCP

EX :

REMOTE	(Set Remote)
TCONFIG OCP	(Set OCP test)
OCP:START 3	(Set start load current 3A)
OCP:STEP 1	(Set step load current 1A)
OCP:STOP 5	(Set stop load current 5A)
VTH 0.6	(Set OCP VTH 0.6V)
IL 0	(Set current low limit 0A)
IH 5	(Set current high limit 5A)
NGENABLE ON	(Set NG Enable ON)
START	(Start OCP testing)
TESTING?	(Ask Testing? 1 : Testing , 0 : Testing End)
NG?	(Ask PASS/FAIL? , 0 : PASS , 1 : FAIL)
OCP?	(Ask OCP current value)
STOP	(Stop OCP testing)

4-12 Power Supply OPP testing

- 4.12.1 There is a method for power supply Over Power Protection (OPP) testing:
Power Supply OPP testing using CC mode method (active by memory recall operation only)
- 4.12.2 OPP test function Enable/Disable Key.
Press “OPP” key to enable the OPP test function and the indicator LED is lit on. The LCD display show “OPP” on upper 5 digits LCD display, shows “PRESS” on middle 5 digits LCD display and shows “START” on lower 5 digits LCD display.



- 4.12.3 OPP test function parameter setting key.
There are 4 parameter for the OPP test function. The parameter as **Pstar**, **Pstep**, **Pstop** and **Vth**.

Press “OPP” key again to set OPP test parameter PSTAR(start power point) When OPP test function is enabled. Press OPP key again to next parameter by the sequence of PSTEP, PSTOP, Vth and disable, press another key also can to exit the setting and save the setting. The OPP test parameter description as following.

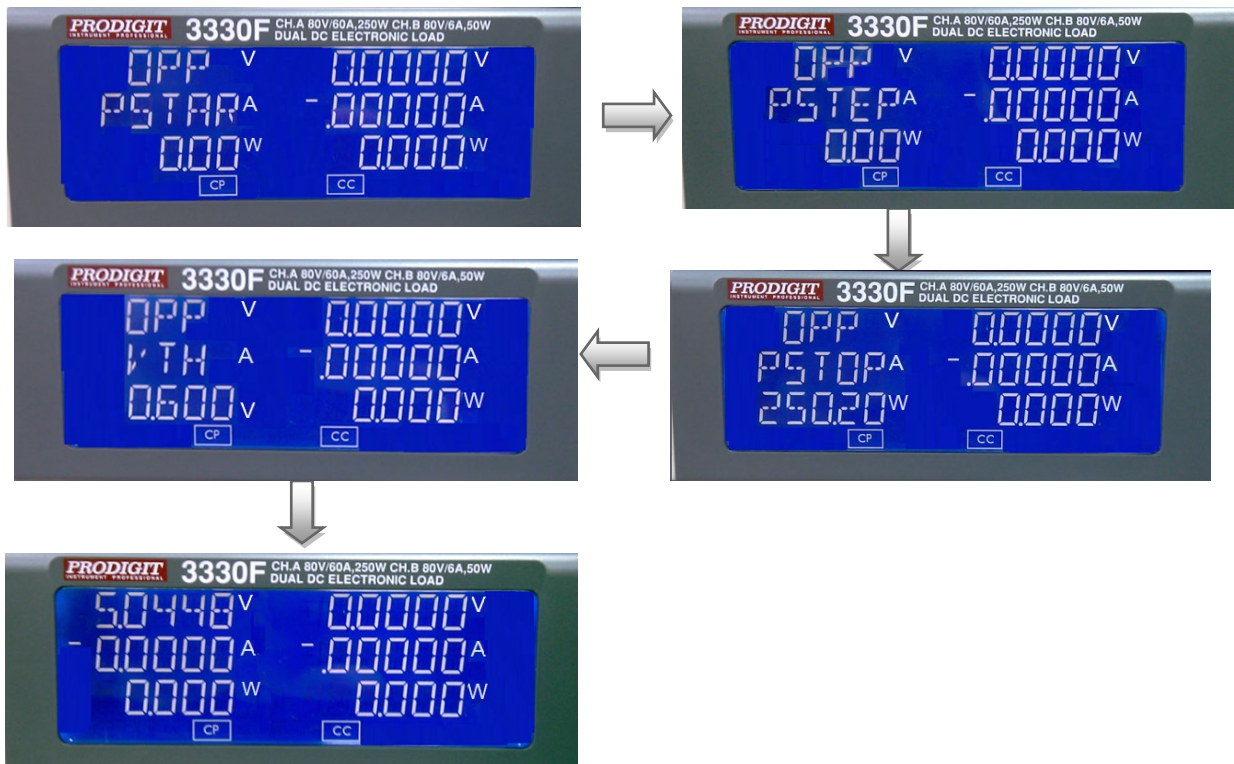

- 4.12.3.1 Pstar : setting the start power point, The LCD display shows “OPP”, “PSTAR” and 0.00W (initial) from upper to lower 5 digits LCD display, the setting range is 0.00W to the full scale of the CP mode specification. The setting is by rotating the setting knob.

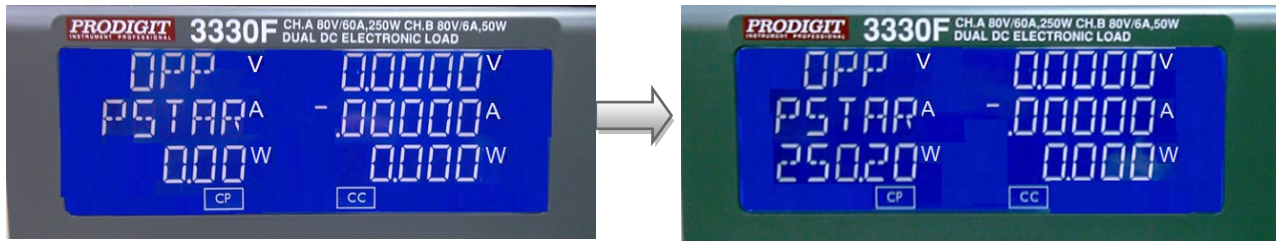

- 4.12.3.2 Pstep : setting the increment step power, The LCD display shows “OPP”, “PSTEP” and 0.00W (initial) from upper to lower 5 digits LCD display, the setting range is 0.00W to the full scale of the CP mode specification. The setting is by rotating the setting knob.

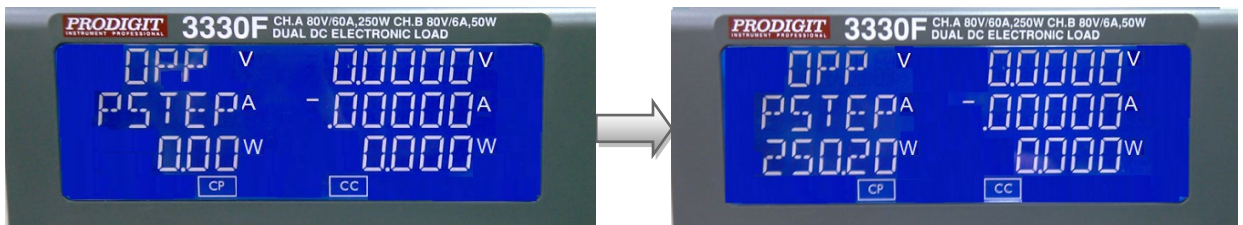

- 4.12.3.3 Pstop : setting the stop power point, The LCD display shows “OPP”, “PSTOP” and 250.00W (3330F CHA initial) from upper to lower 5 digits LCD display, the setting range is 0.00W to the full scale of the CP mode specification. The setting is by rotating the setting knob.

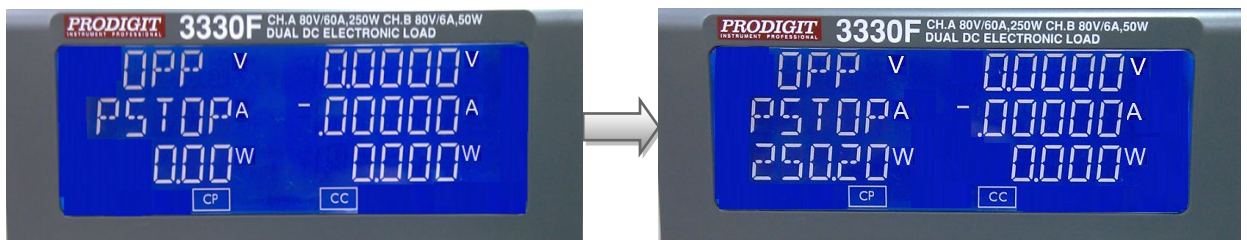

- 4.12.3.4 Vth : Setting threshold voltage; The LCD display shows “OPP”, “Vth” and 0.600V (3330F initial) from upper to lower 5 digits LCD display, the setting range is 0.00V to the full scale of the Voltage specification. The setting is by rotating the setting knob.

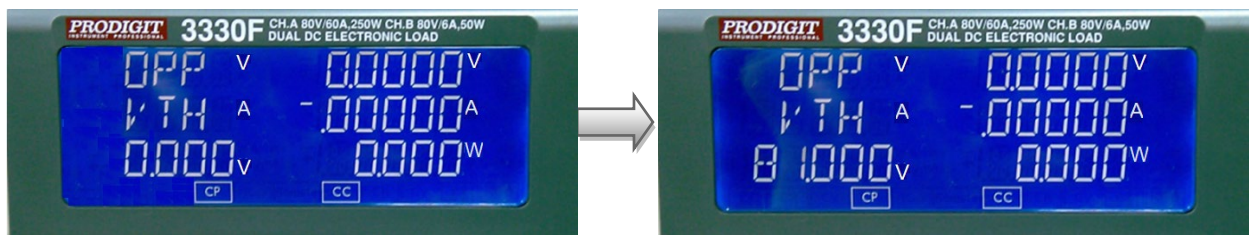

4.12.4 START/STOP Test key.

Press START/STOP key to start or stop the OPP test by OPP test setting parameter when OPP test function is enabled.

The Load will go to "ON" automatically when press START/STOP key to start the OPP test and the Load will go to "OFF" automatically when press START/STOP key to stop the OPP test. The Load will stay to "ON" if load was "ON" before OPP test.

The OPP test function for test the UUT's over power protection, The OPP test will start sink current from PSTART to increase PSTEP current until the UUT's output voltage drop-out lower than the threshold voltage (V-th setting), and the OPP trip point is between W_Hi and W_Lo limitation, then lower 5 digits LCD display will show "PASS", otherwise shows "FAIL".

Press any key to go to normal mode of LCD display.

4.12.5 OPP Manual control

Example:

4.12.5.1. Setting OPP test, press OPP key to the next step.



4.12.5.2. Setting start load watt 0W, press OPP key to the next step.



4.12.5.3. Press up key, set step load watt 0.02W, press OPP key to the next step.



4.12.5.4. Press up key, set stop load watt 3.25W, press OPP key to the next step.



4.12.5.5. Setting OPP VTH 0.6V, press OPP key to the next step.



4.12.5.6. Press START/STOP Test key.

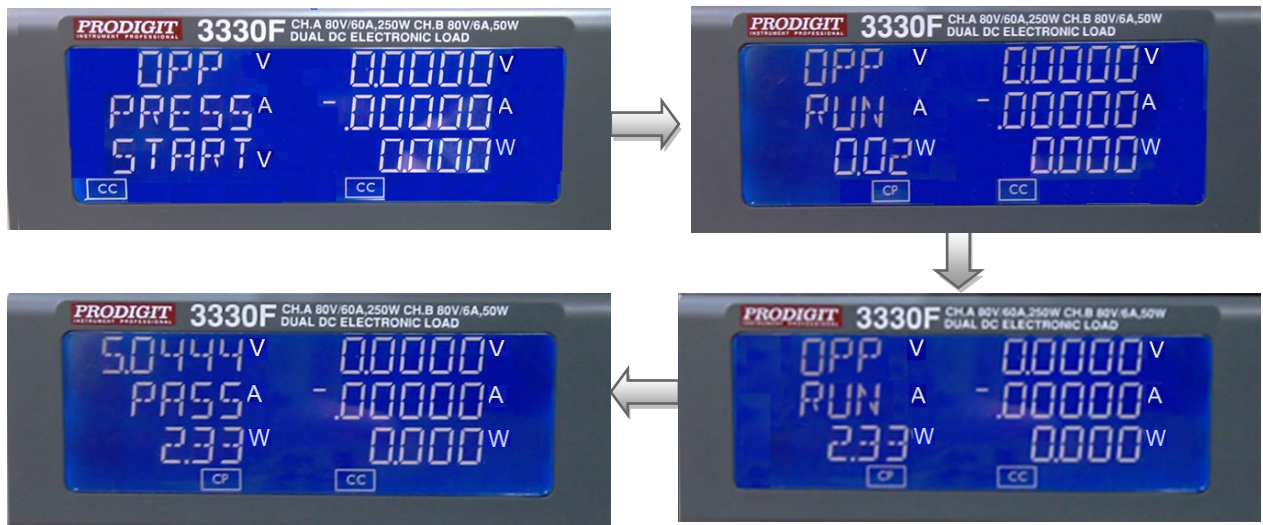

- 4.12.5.7. the UUT's output voltage drop-out lower than the threshold voltage (V-th setting), and the OPP trip point is between W_Hi and W_Lo limitation, then lower 5 digits LCD display will shows "PASS", otherwise shows "FAIL".



4.12.6 Remote control OPP

EX :

REMOTE	(Set Remote)
TCONFIG OPP	(Set OCP test)
OPP:START 3	(Set start load watt 3W)
OPP:STEP 1	(Set step load watt 1W)
OPP:STOP 5	(Set stop load watt 5W)
VTH 0.6	(Set OPP VTH 0.6V)
WL 0	(Set watt low limit 0W)
WH 5	(Set watt high limit 5W)
NGENABLE ON	(Set NG Enable ON)
START	(Start OPP testing)
TESTING?	(Ask Testing? 1 : Testing , 0 : Testing End)
NG?	(Ask PASS/FAIL? , 0 : PASS , 1 : FAIL)
OPP?	(Ask OPP watt value)
STOP	(Stop OPP testing)

4-13 Power Supply SHORT testing

- 4.13.1 The low short resistance is implemented by drives the Power MOSFET to the Maximum rated load current at SHORT ON mode and Load ON status.
- 4.13.2 Short test function Enable/Disable Key.
Press “SHORT” key to enable the short test function and the indicator LED is lit on. The LCD display show “SHORT” on upper 5 digits LCD display, shows “PRESS” on middle 5 digits LCD display and shows “START” on lower 5 digits LCD display.



- 4.13.3 Short test function parameter setting key.
There are 3 parameter for the SHORT test function. The parameter as TIME, V-Hi and V-Lo.
Press “SHORT” key again to set short test time when SHORT test function is enabled. Press SHORT key again to next parameter by the sequence of **TIME**, **V-Hi**, **V-Lo** and disable, press another key to exit the setting and save the setting. The short test parameter description as following.



- 4.12.3.1 **TIME**: setting the short test time, The LCD display shows “SHORT”, “TIME” and CONTI (initial) from upper to lower 5 digits LCD display, the Setting range is “CONTI” means continue, 100mS to 10000mS step 100mS by clockwise rotate the setting knob.
The short test will be no time limitation when setting to CONTI until press “START/STOP” key to stop the short test.

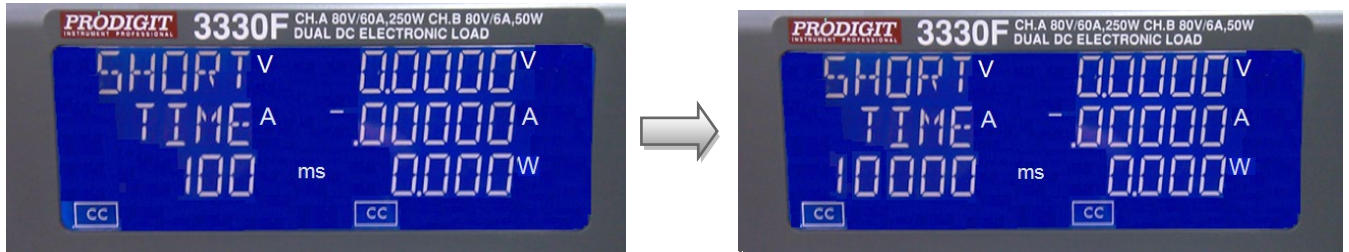

- 4.12.3.2 **V-Hi**: Short test voltage check upper limitation setting, The LCD display Shows “SHORT”, “V-Hi” and 0.00V (initial) from upper to lower 5 digits, the V-Hi setting range from 0.000V to 81.000V step 0.00135V by rotating the setting knob.

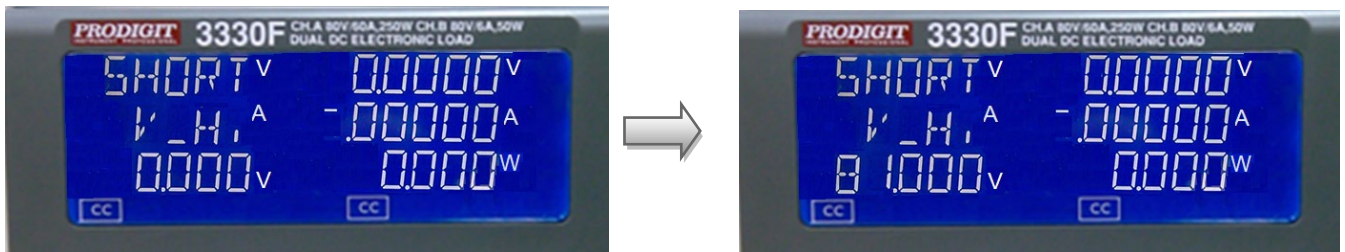

- **V-Lo** : Short test voltage check lower limitation setting, The LCD display shows “SHORT”, “V-Lo” and 0.00V(initial) from upper to lower 5 digits, the V-Hi setting range from 0.000V to 81.000V step 0.00135V by rotating the setting knob.

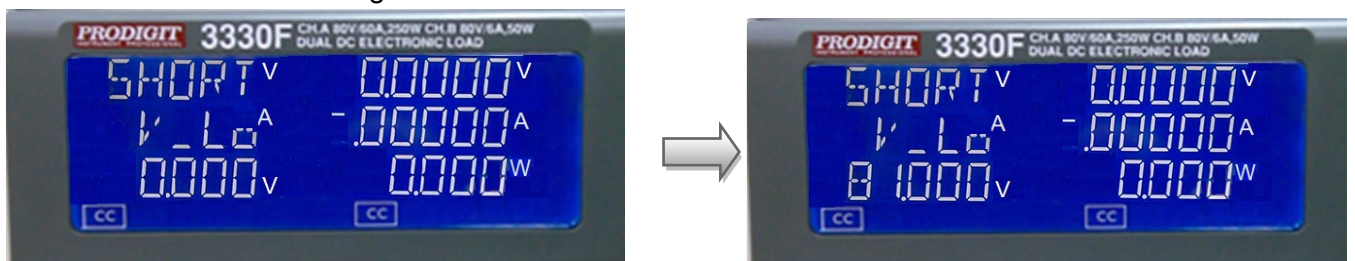

Note. The V-Hi and V-Lo parameter is difference with the V-Hi and V-Lo in the LIMIT function.

4.13.4 START/STOP Test key.

Press START/STOP key to start or stop the short test by SHORT test setting parameter when SHORT test function is enabled.

The Load will goes to “ON” automatically when press START/STOP key to start the short test and the Load will goes to “OFF” automatically when press START/STOP key to stop the short test. The Load will stay to “ON” If load was “ON” before short test.

The SHORT test function for test the UUT's short protection, The SHORT test will sink load's full scale current(3330F CHA 60A) until to fit in with the test condition, and the UUT's drop voltage is between V_Hi and V_Lo limitation, then middle 5 digits LCD display will shows "PASS", otherwise shows "FAIL".
Press any key to goes to normal mode of LCD display.

4.13.5 SHORT Manual control

Example:

4.13.5.1. Setting SHORT test, press Short key to the next step.



4.13.5.2. Press UP key, setting Short time to 10000ms, press Short key to the next Step.

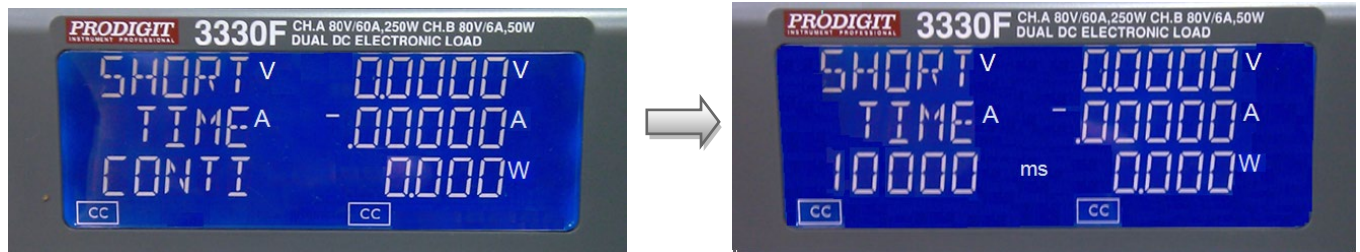

4.13.5.3. Press down key, setting V-Hi voltage to 1V, press Short key to the next Step.



4.13.5.4. Press down key, setting V-Lo voltage to 0V, press Short key to the next Step.



4.13.5.5. Press START/STOP test key.



4.13.5.6. Short test finish, the UUT's drop voltage is between V_Hi and V_Lo limitation, then middle 5 digits LCD display will shows "PASS"



4.13.5.7. The UUT's not drop voltage is between V_Hi and V_Lo limitation, LCD display will shows FAIL.



4.13.6 Remote control SHORT

EX :

REMOTE	(Set Remote)
TCONFIG SHORT	(Set SHORT test)
STIME 1	(Set short time 1ms)
START	(Start SHORT testing)
TESTING?	(Ask Testing? 1 : Testing , 0 : Testing End)
STOP	(Stop SHORT testing)