

Dual Measurement Multimeter

GDM-9052

USER MANUAL

REV. A



ISO-9001 CERTIFIED MANUFACTURER

GW INSTEK

This manual contains proprietary information, which is protected by copyrights. All rights are reserved. No part of this manual may be photocopied, reproduced or translated to another language without prior written consent of Good Will company.

The information in this manual was correct at the time of printing. However, Good Will continues to improve products and reserves the right to change specifications, equipment, and maintenance procedures at any time without notice.

Good Will Instrument Co., Ltd.

No. 7-1, Jhongsing Rd., Tucheng Dist., New Taipei City 236, Taiwan (R.O.C.).

Table of Contents

SAFETY INSTRUCTIONS	5
Safety Symbols.....	5
Safety Guidelines	6
GETTING STARTED	9
Characteristics	10
Front Panel Overview	12
Front Panel Overview	18
Status Bar.....	20
Set Up	23
BASIC MEASUREMENT	25
Basic Measurement Overview.....	27
AC/DC Voltage Measurement	30
AC/DC Current Measurement	36
2W/4W Resistance Measurement	39
Continuity Test.....	42
Diode Measurement.....	44
Frequency/Period Measurement.....	45
Capacitance Measurement	49
Temperature Measurement	52
A.I. (Auto Identification) Measurement.....	55
DUAL MEASUREMENT	56
Dual Measurement.....	57
ADVANCED MEASUREMENT	66
Advanced Measurement Overview.....	67
Relative Value Measurement	68
Hold Measurement	70
Trigger Setting	72
Filter Setting.....	75
Math Measurement	78
DIGITAL I/O	94
Normal Mode	96
User Mode.....	97

SYSTEM & FIRMWARE	98
View System Info	99
MENU SETTING	100
Configure System	101
REMOTE CONTROL	110
Configure Interface	111
Command Syntax	122
Command Set	125
Status system.....	154
APPENDIX	155
Fuse Replacement.....	157
Battery Replacement.....	161
Factory Default Parameters	163
Specifications	166
Additional Specifications	171
Declaration of Conformity	178
INDEX	179

S SAFETY INSTRUCTIONS

This chapter contains important safety instructions that you must follow when operating the GDM-9052 and when keeping it in storage. Read the following before any operation to ensure your safety and to keep the GDM-9052 in the best possible condition.

Safety Symbols

These safety symbols may appear in this manual or on the GDM-9052.



WARNING

Warning: Identifies conditions or practices that could result in injury or loss of life.



CAUTION

Caution: Identifies conditions or practices that could result in damage to the GDM-9052 or to other property.



DANGER High Voltage



Attention Refer to the Manual



Protective Conductor Terminal



Earth (ground) Terminal



Do not dispose electronic equipment as unsorted municipal waste. Please use a separate collection facility or contact the supplier from which this instrument was purchased.

Safety Guidelines

General Guideline



CAUTION

- Make sure that the voltage input level does not exceed DC 1000 V/AC 750 V.
- Make sure the current input level does not exceed 12 A.
- Do not place any heavy object on the instrument.
- Avoid severe impact or rough handling that can lead to damaging the instrument.
- Do not discharge static electricity to the instrument.
- Use only mating connectors, not bare wires, for the terminals.
- Do not perform measurement at the source of a low-voltage installation or at building installations (Note below).
- Do not disassemble the instrument unless you are qualified as service personnel.

(Note) EN 61010-1:2010 specifies the measurement categories and their requirements as follows. The GDM-9052 falls under category II 300 V.

- Measurement category IV is for measurement performed at the source of low-voltage installation.
- Measurement category III is for measurement performed in the building installation.
- Measurement category II is for measurement performed on the circuits directly connected to the low voltage installation.

Power Supply



WARNING

- AC Input voltage: AC 100 V / 120 V / 220 V / 240 V $\pm 10\%$, 50 Hz / 60 Hz
 - The power supply voltage should not fluctuate more than 10 %.
 - Connect the protective grounding conductor of the AC power cord to an earth ground, to avoid electrical shock.
-

Power Cord Requirement If the equipment is used in a manner not specified by the manufacturer, the protection provided by the equipment may be impaired. Do NOT replace the detachable MAINS supply cords by inadequately RATED cords.

Suitable supply cord set for use with the equipment:

- Mains plug: Shall be national approval
- Mains connector: C13 type
- Cable:
 1. Length of power supply cord: less than 3 m
 2. Cross-section of conductors: at least 0.75 mm²
 3. Cord type shall meet the requirements of IEC 60227 or IEC 60245 (e.g.: H05VV-F, H05RN-F)

Fuse



WARNING

- Fuse type: T0.315 A 100 V / 120 VAC
T0.16 A 220 V / 240 VAC
- Make sure the correct type of fuse is installed before power up.
- To avoid risk of fire, replace the fuse only with the specified type and rating.
- Disconnect the power cord before fuse replacement.
- Make sure the cause of a fuse blowout is fixed before fuse replacement.

Cleaning the Instrument

- Disconnect the power cord before cleaning.
- Use a soft cloth dampened in a solution of mild detergent and water. Do not spray any liquid into the GDM-9052.
- Do not use chemicals or cleaners containing harsh material such as benzene, toluene, xylene, and acetone.

Operation Environment

- Location: Indoor, no direct sunlight, dust free, almost non-conductive pollution (Note below)
- Temperature: Full accuracy for 0 °C to 50 °C.
- Humidity:
 - < 30 °C: < 80 %RH(non-condensing);
 - 30 °C to 40 °C:< 70 %RH(non-condensing);
 - > 40 °C: < 50 %RH (non-condensing)
- Altitude: < 2000 m

(Note) EN 61010-1 specifies the pollution degrees and their requirements as follows. The GDM-9052 falls under degree 2.

Pollution refers to “addition of foreign matter, solid, liquid, or gaseous (ionized gases), that may produce a reduction of dielectric strength or surface resistivity”.

- Pollution degree 1: No pollution or only dry, non-conductive pollution occurs. The pollution has no influence.
- Pollution degree 2: Normally only non-conductive pollution occurs. Occasionally, however, a temporary conductivity caused by condensation must be expected.
- Pollution degree 3: Conductive pollution occurs, or dry, non-conductive pollution occurs which becomes conductive due to condensation which is expected. In such conditions, equipment is normally protected against exposure to direct sunlight, precipitation, and full wind pressure, but neither temperature nor humidity is controlled.

Storage Environment

- Location: Indoor
- Temperature: -40 °C to 70 °C
- Humidity: < 90 %RH(non-condensing)

Disposal



Do not dispose this instrument as unsorted municipal waste. Please use a separate collection facility or contact the supplier from which this instrument was purchased. Please make sure discarded electrical waste is properly recycled to reduce environmental impact.

GETTING STARTED

This chapter describes the GDM-9052 in a nutshell, including an Overview of its main features and front / rear panel introduction. After going through the Overview, follow the Power-up sequence to properly setup the GDM-9052.

Please note the information in this manual was correct at the time of printing. However, as GW Instek continues to improve its products, changes can occur at any time without notice. Please see the GW Instek website for the latest information and content.

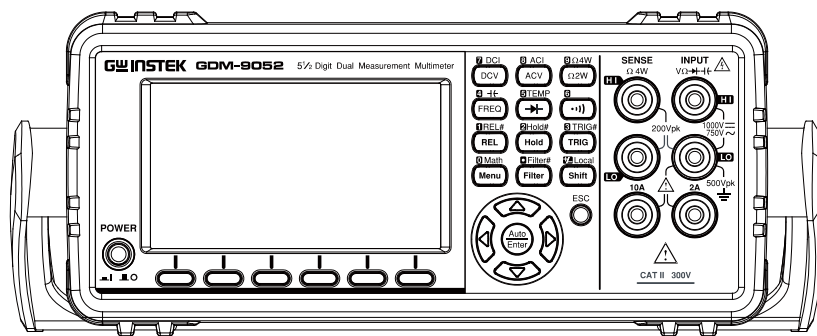

Characteristics	10
Accessories	11
Front Panel Overview	12
Measurement Keys (Basic)	15
Measurement Keys (Advanced)	17
Front Panel Overview	18
Status Bar	20
Set Up	23
Horizontal/Tilt/Vertical Applications	23
Power Up	24

Characteristics

The GDM-9052 is a portable, dual-display digital multimeter suitable for a wide range of applications, such as production testing, research, and field verification.

Performance	<ul style="list-style-type: none">• The highest DCV accuracy: 0.012 %• The highest current: 10 A• The highest voltage: 1000 V• The highest ACV frequency response: 100 kHz
Features	<ul style="list-style-type: none">• The fastest sampling rate is (320 Readings / sec) for ADC and PC transmission.• The diode test open-circuit voltage is $\div 6 \text{ V} / 1 \text{ mA}$.• 240000 count display• Multiple functions: ACV, DCV, ACI, DCI, 2WR, 4WR, Cap, Freq, Period, Temp, Continuity, Diode test, MAX/MIN, Avg, REL, dB, dBm, Hold, MX+B, 1/X, REF, %, Compare.• Manual or Auto ranging• AC true RMS
Software	<ul style="list-style-type: none">• Excel Addins
Interface	<ul style="list-style-type: none">• USB device port supports USB CDC and USB TMC.• RS232• Digital I/O port can be used in either pass/fail testing (Compare function) or have the output state remotely controlled. Only one function at a time can be used.



Accessories

Standard Accessories	Part number	Description
	82DM-90610MA1	Safety Instruction Sheet
	GTL-207A	Test leads: 1x red, 1x black
Optional Accessories	Part number	Description
	GBM-01	4 Wire (kelvin clip) test lead, 90 V (max.), approx. 1100 mm
	GTL-246	USB Cable, USB 2.0, A-B type, 1200 mm
	GTL-205A	Temperature Probe Adapter with Thermal Coupling (K-type)
	GDM-TL1	<ul style="list-style-type: none"> ▪ Test lead probes with CAT IV 600 V sheath x 2 ▪ Fine tip probes x 2 ▪ SMT Grabbers x 2 ▪ Mini Grabber x 1
	GSC-014	Soft carrying case for DMM accessory
	GRA-422	Rack Mount Kit (19" 2U)
	GRA-454	Rack Mount Kit (19", 2U) for two sets

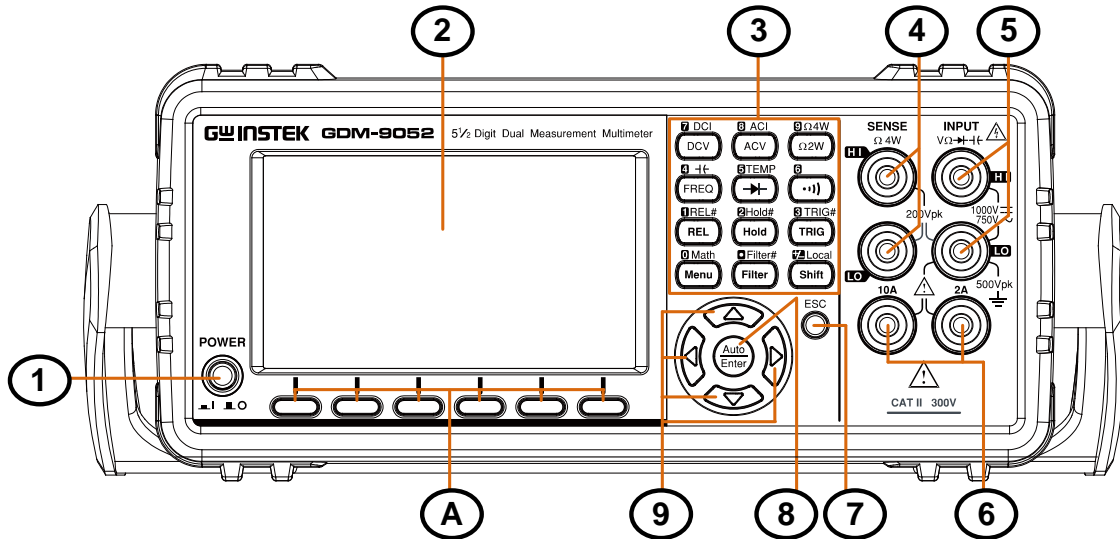
Front Panel Overview



Item	Description
1	Power Switch
2	Main Display
3	Measurement Keys
4	HI and LO Sense Terminals
5	HI and LO Input Terminals
6	AC/DC Current Input Terminals
7	ESC (Escape) Key
8	Auto Range/Enter Key
9	Arrow Keys
A	Function keys (F1 through F6, functions vary per modes)

Power Switch  Turn On  or Off  the main power. For the power up sequence, see page 24.

Main Display The 4.3" TFT LCD shows measurement results and parameters. For display configurations, see page 105.

Measurement Keys There are 4 rows in total of both basic and advanced measurement keys deployed on the front panel. For the details, refer to page 15 and page 17.

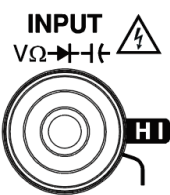
Input HI Terminal  Used as an input port for all measurements except for DC/AC Current measurements.

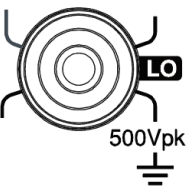
Input LO Terminal  Accepts ground (COM) line in all measurements except the sense line in 4W Resistance (page 39). The maximum withstand voltage between this terminal and earth is 500 Vpk.

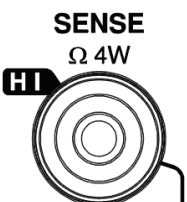
Sense HI Terminal  Accepts HI sense line in 4W resistance measurement. For details, see page 39.

Sense LO Terminal  Accepts LO sense line in 4W resistance measurement. For details, see page 39.

DC/AC 2A Terminal

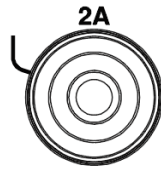

DC/AC current input

DC: 20 mA to 2 A

AC: 20 mA to 2 A

For DCI or ACI details, see page 36.

DC/AC 10A Terminal

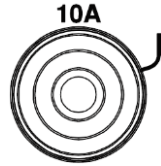

Accept DC/AC Current input.

DC: 2 A to 10 A

AC: 2 A to 10 A

For DCI or ACI details, see page 36.

ESC (Escape) Key



Single press to escape from current page to the previous page.

Range Selection / Enter Key



Press the Auto key to activate auto-range mode when under measurement display. Press the Enter key to confirm setting when under parameter configuration.

Arrow Keys



Press the left or right arrow key to move parameter cursor rightward or leftward. Press the up or down key to increase or decrease value for parameter configuration.

Function Keys

The 6 keys have varied functions per different settings.

Measurement Keys (Basic)

Background The upper 2 rows of measurement keys are used for basic measurements. Each key has a primary and secondary function individually. The secondary function is accessed in conjunction with the Shift key.

Shift  The Shift key is used to select the secondary functions assigned to each front panel key. When pressed, the Shift indicator appears in the display.

Local  For the Local key, it helps release from the remote control and returns the instrument to local panel operation (page 111).

ACV  Measures AC Voltage (page 30).





Shift → ACV (ACI)  →  Measures AC Current (page 36).

DCV  Measures DC Voltage (page 30).

Shift → DCV (DCI)  →  Measures DC Current (page 36).



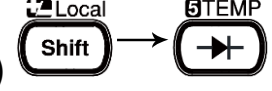

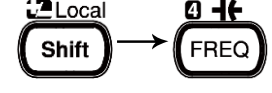









Ω2W (Resistance)  Measures 2-wire Resistance (page 39).

Shift → Ω2W (Ω4W Resistance)  →  Measures 4-wire Resistance (page 39).

••) (Continuity)		Tests Continuity (page 42).
→ (Diode)		Tests Diode (page 44).
Shift → → Diode (TEMP Temperature)		Measures Temperature (page 52).
FREQ (Frequency)		Measures Frequency (page 45).
Shift → FREQ (Capacitance →)		Measures Capacitance (page 49).

Measurement Keys (Advanced)

Background The lower 2 rows of measurement keys are used for more advanced functions. Each key has a primary and secondary function. The secondary function is accessed in conjunction with the Shift key.

REL		Measures the Relative value (page 68).
Shift → REL (REL#)	 → 	Manually sets the reference value for the Relative value measurement (page 68).
Hold		Activates the Hold function (page 70).
Shift → Hold (Hold#)	 → 	Manually sets the parameters for the Hold measurement (page 70).
TRIG (Trigger)		Activates the Trigger function (page 72).
Shift → TRIG (TRIG#)	 → 	Sets the parameters for the Trigger function (page 72).
Menu		Enters the setting pages in various Menus (page 101).
Shift → Menu (Math)	 → 	The Math functions including dB, dBm, Compare, MX+B, 1/X and Percent manually (page 78).
Filter		Manually sets the parameters for the Filter function (page 75).
Shift → Filter (Filter#)	 → 	Activates the Filter function (page 75).

Front Panel Overview

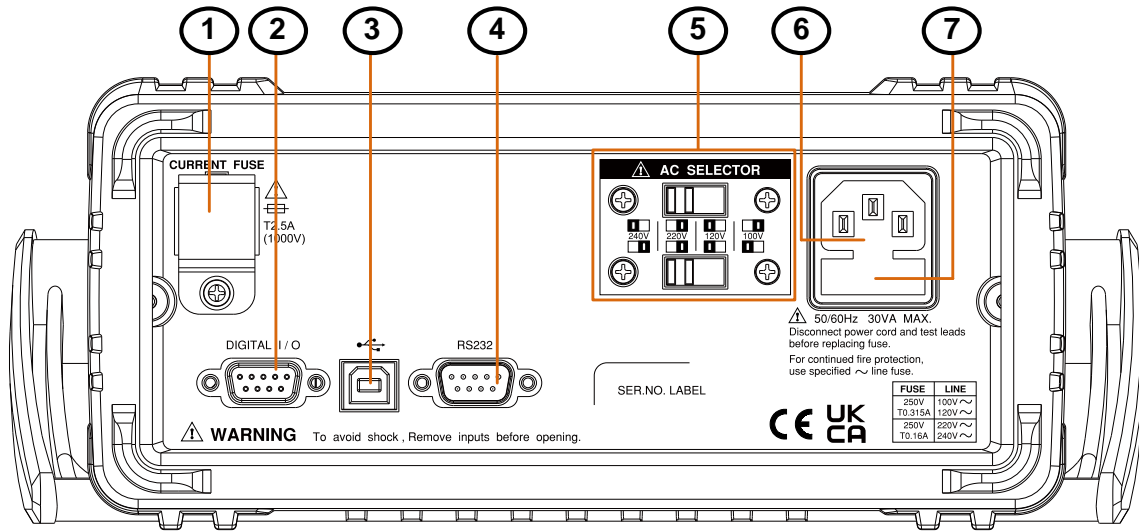

Item	Description
1	Current Fuse Box
2	DIGITAL I/O Connector
3	USB Connector (B Type)
4	RS-232 Interface Connector
5	Alternate Input Switch
6	AC Mains Input (Power Cord Socket)
7	AC Mains Fuse Socket

Current Fuse Box

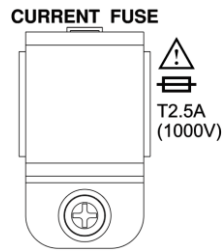

Holds the current fuse: T2.5 A, 1000 V , 6*30 mm

For fuse replacement details, see page 158.

Digital I/O port

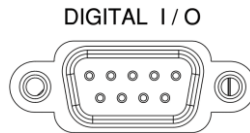

Accepts a digital I/O cable for the Hi/Lo limit tests; DB-9 pin, female connector. For digital I/O details, see page 95.

USB device port

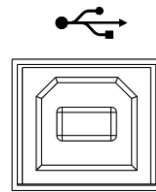

Accepts a USB device cable for remote control; Type B, female connector.

For remote control details, see page 112.

RS-232 port

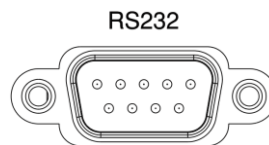

Accepts an RS-232 cable for remote control; DB-9 male connector. For remote control details, see page 116.

Alternate Input Switch

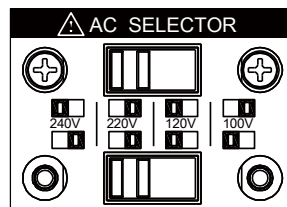

AC voltage selection:

100 V/ 120 V/ 220 V/ 240 V
± 10 %, 50 Hz / 60 Hz

Power Cord Socket

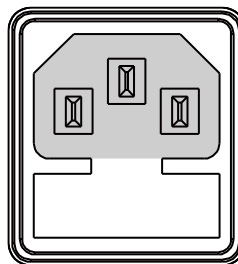

Accepts the power cord. AC 100 V / 120 V / 220 V / 240 V ± 10 %, 50 Hz/60 Hz ± 10 %.

For power on sequence, see page 24.

Fuse Socket

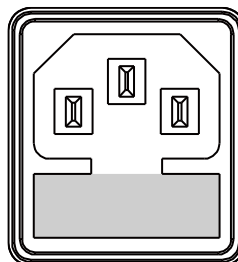

Holds the main fuse:

100 V / 120 VAC: T0.315 A
220 V / 240 VAC: T0.16 A

For fuse replacement details, see page 157.







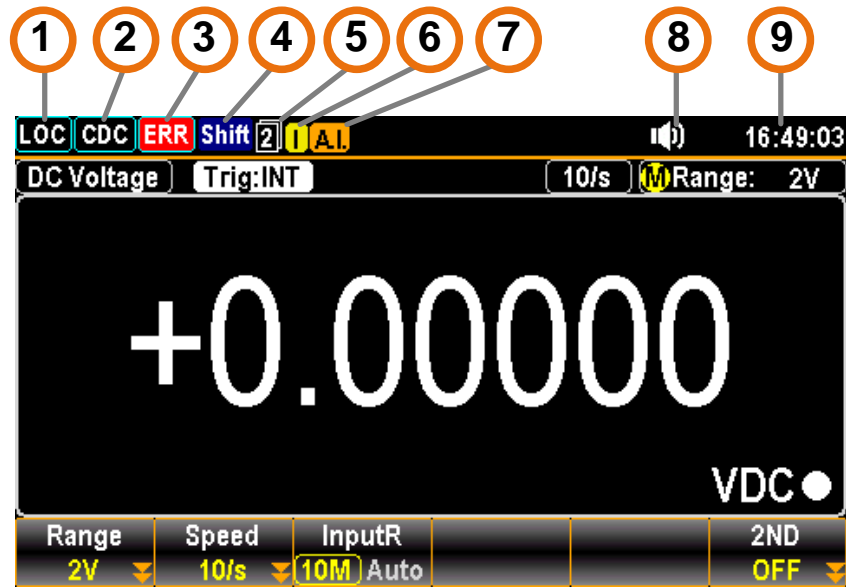





Status Bar





Background Identify each icon within the top status bar.

Status Bar Display



Item	Description
1	Local/Remote control icon
2	USB-CDC/USB-TMC interface icon
3	Error icon for commands from remote control
4	Shift key identification icon
5	The first and second function menu switch icon
6	Digital I/O activation icon
7	Auto Identification for input source measurement
8	Beep/Key Sound setting icon
9	Time display

Local Control		It indicates the unit is under local control mode.
Remote Control		It indicates the unit is under remote control. Refer to page 110 for details.
USB - CDC		It indicates USB - CDC interface is activated. Refer to page 115 for details.
USB - TMC		It indicates USB - TMC interface is activated. Refer to page 115 for details.
RS-232		It indicates RS-232 interface is activated. Refer to page 151 for details.
ERROR		It indicates error occurs in commands. To erase the error icon, it is required to read or sweep the error by remote control commands or reboot action.
Shift		It indicates the shift key is being pressed ready for in conjunction with other keys for additional functions. Refer to page 15 for details.
First function menu		It indicates the active bottom menu corresponding to function keys is the first menu. Click the Enter key to switch to the second function menu.
Second function menu		It indicates the active bottom menu corresponding to functional keys is the second menu. Click the Enter key to switch to the first function menu.
Digital I/O – User mode		It indicates Digital I/O – User mode is enabled. Refer to page 97 for details.
A.I. (Automatic Identification)		It indicates the Auto Identification for measurement of different sources. Refer to page 55 for details.
Sound – Beep		It indicates sound of beep is enabled. Refer to page 101 for details.

Sound - Key		It indicates sound of key is enabled. Refer to page 102 for details.
Sound – All		It indicates sounds of beep and key are both enabled.
Sound – Off		It indicates sounds of beep and key are both disabled.
Time Display		It indicates the time display. For detailed setting, refer to page 104.

Set Up

Horizontal/Tilt/Vertical Applications

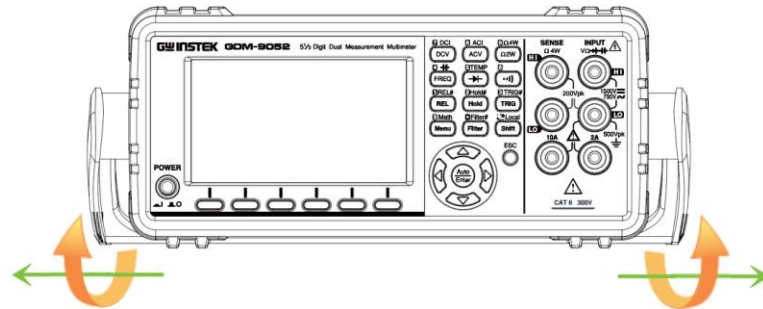

Pull out the handle sideways and rotate it clockwise for the applications below.

Horizontal

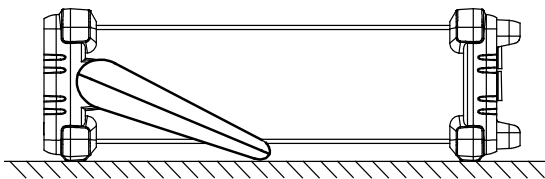

Place the unit horizontally.

Tilt

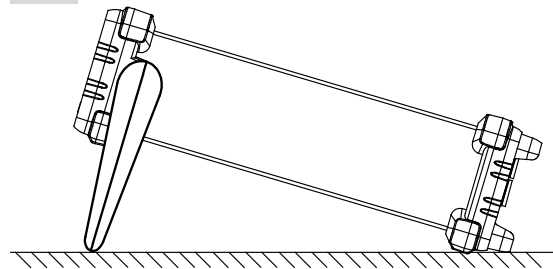

Rotate the handle for tilt stand.

Vertical

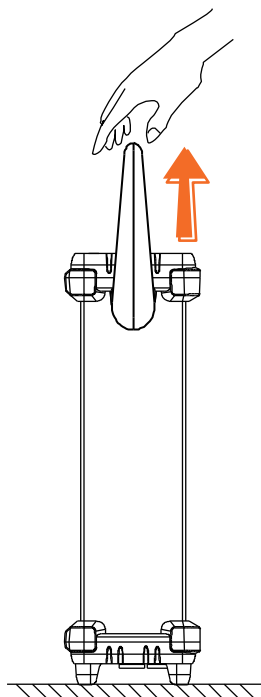

Place the handle vertically for hand carry.

Power Up

Steps

1. Before the power is turned on, confirm the input power supply meets the following conditions:
100 V / 120 V / 220 V / 240 V
 $\pm 10 \%$, 50 Hz / 60 Hz

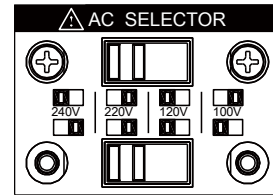

2. The fuse is a slow-blow fuse.
T0.16 A (220 V / 240 V),
T0.315 A (100 V / 120 V)
Confirm that the fuse is of the correct type and rating before connecting the power cord.

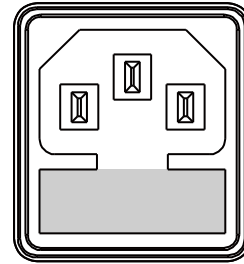

3. Connect the power cord to the the AC Voltage input.

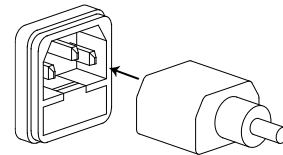

Make sure the ground connector on the power cord is connected to a safety ground. This will affect the measurement accuracy.

4. Push the power button until click to turn on the main power switch on the front panel.

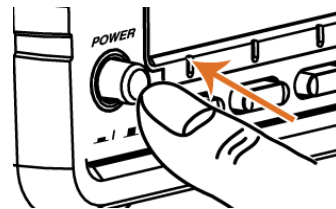

5. The screen firstly shows the logo brand of GWINSTEK followed by the message “Load the parameter [Last] is ok” indicating the last parameter is loaded in the initial startup.

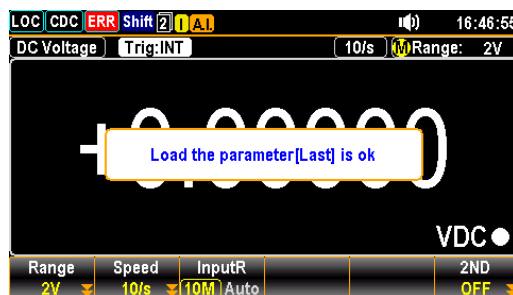

BASIC MEASUREMENT



Basic Measurement Overview	27
Refresh Rate	27
Internal (Automatic) Triggering.....	29
AC/DC Voltage Measurement	30
Select Voltage Range	31
General Voltage Setting.....	32
Voltage Conversion Table	34
Crest Factor Table	35
AC/DC Current Measurement	36
Select Current Range.....	37
General Current Setting.....	38
2W/4W Resistance Measurement	39
Select Resistance Range	41
General Resistance Setting	41
Continuity Test	42
Set Continuity Threshold	43
Diode Measurement	44
Frequency/Period Measurement.....	45
Frequency/Period In-Depth Setting.....	47
Capacitance Measurement	49
Cable Open Function.....	50
Select Capacitance Range	51
Temperature Measurement	52
General Temperature Setting	53
Thermocouple Sensor Type	53

Reference Junction Temperature (SIM Temperature)	54
Thermocouple Setting	54
A.I. (Auto Identification) Measurement	55

Basic Measurement Overview

Background Basic measurement refers to the several types of measurements assigned to the upper 2 row keys on the front panel.



Measurement type	ACV	AC Voltage
	DCV	DC Voltage
	ACI	AC Current
	DCI	DC Current
	Ω 2W/ Ω 4W	2-wire and 4-wire Resistance
	•))	Continuity
	FREQ ⇄	Frequency/Capacitance
	TEMP →	Temperature/Diode

Advanced measurement Advanced measurement (page 64) mainly refers to the operation using the result obtained from one or more of the basic measurements.

Refresh Rate

Background Refresh rate defines how frequently the GDM-9052 captures and updates measurement data. A faster refresh rate yields a lower accuracy and resolution. A slower refresh rate yields a higher accuracy and resolution. Consider these tradeoffs when selecting the refresh rate.

Measurement Type	Refresh Rate Available		
DCV/DCI	10 /s	40 /s	320 /s
ACV/ACI	10 /s	40 /s	320 /s
Continuity / Diode	10/s	40 /s	320 /s
Frequency & Period	1 s	100 ms	10 ms
Temperature	10 /s	40 /s	320 /s
Resistance	10 /s	40 /s	320 /s
Capacitance	2 /s	2 /s	2 /s

Selection Procedure

Press the left or right Arrow keys to change the refresh rate.



Also, press the F2 (Speed) key to select a desired refresh rate. Press corresponding function key in accord with the desired option on display.

Speed



The refresh rate will be shown at the upper right corner of the display. See the example below.

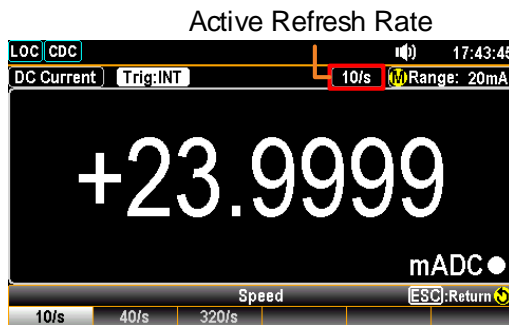

! Note

The refresh rate cannot be set for capacitance measurement.

Reading indicator

The reading indicator , which is located in the lower-right corner of display, flashes according to the defined refresh rate setting.



Reading Indicator

Internal (Automatic) Triggering

Overview By default, the GDM-9052 automatically triggers measurement according to the set refresh rate. See the previous page for refresh rate setting details. The TRIG key, on the other hand, can be used to manually trigger once per click.

SIN (Manual) Trigger Simply press the TRIG key to SIN trigger mode, which signifies manual triggering measurement. Pressing once stands for trigger for single time.



Indicator SIN Trigger Mode

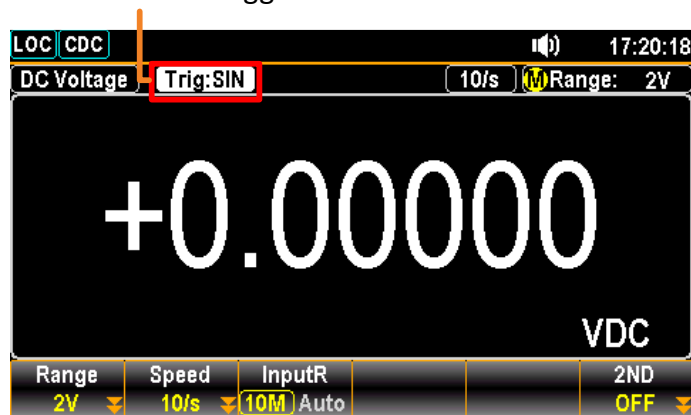

INT (Auto) Trigger Press and hold the TRIG key for 2 seconds to change to INT (Auto) trigger mode, which stands that automatic triggering measurement per refresh rate.



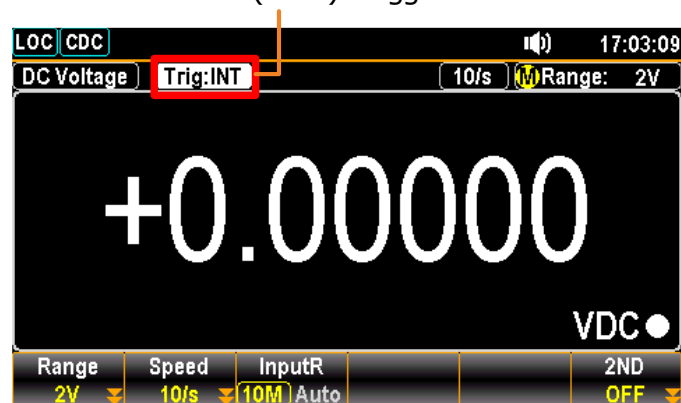

Indicator INT (Auto) Trigger Mode



Note Single triggering is not supported for capacitance measurements.

AC/DC Voltage Measurement

Voltage type	AC	0 to 750 V
	DC	0 to 1000 V

Activate ACV/DCV	Press the ACV key or DCV key to measure AC or DC voltage, respectively.	 or 
------------------	---	--

ACV/DCV mode display appears The mode will switch to ACV, DCV mode immediately. See the figure below for example.

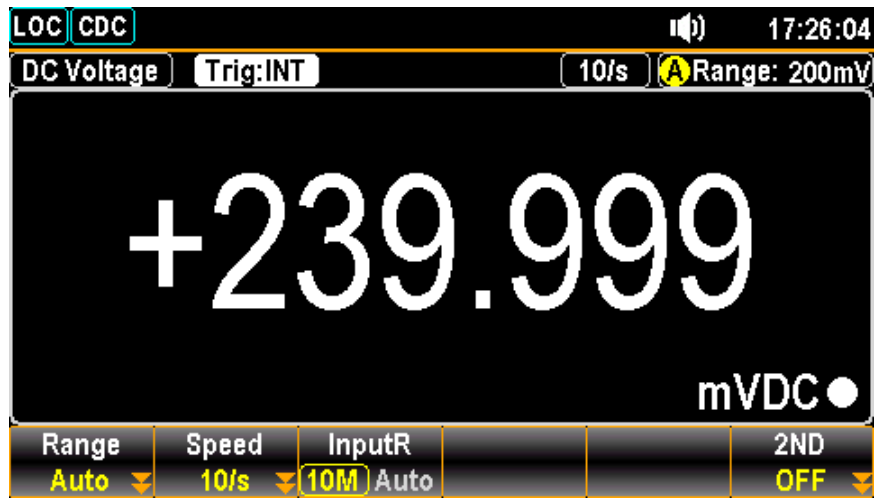



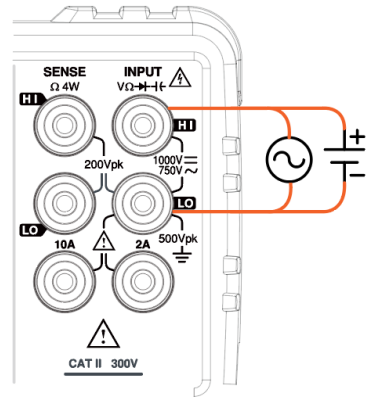

DC or AC Voltage	Indicates DC or AC Voltage mode
10/s	Indicates the active refresh rate
	Indicates Automatic range selection
Range: 200 mV	Indicates the available range of Voltage
+239.999 mVDC	Indicates the exact measured value

Connect the test lead and measure Connect the test lead between the Input HI and Input LO terminals. The display updates the reading.



Select Voltage Range

Auto range To turn the automatic range selection On/Off, press the Auto key. 

Manual range Press the up or down arrow key to select the range. The Auto indicator  turns to  indicating Manual range selection. 

If the appropriate range is unknown, select the highest range.

You can also press the F1 (Range) key to select a desired range. 

Press the F1 to F6 key to select a desired range for the voltage measurement.



Selection list	Range		
	Range	Resolution	Full scale
	200 mV	1 μ V	239.999 mV
	2 V	10 μ V	2.39999 V
	20 V	0.1 mV	23.9999 V
	200 V	1 mV	239.999 V
	750 V	10 mV	765.00 V
	1000 V (DC)	10 mV	1020.00 V

 **Note** For more detailed parameters, see the specifications on page 166.

General Voltage Setting

F2 (Speed) key to select refresh rate

DCV/ACV:

Speed

Press the F1 to F3 key to select the desired rate



F3 (Input R) key to select input resistance

Background Specify the input impedance to the test leads (Input R). This specifies the measurement terminal input impedance, which is either Auto or 10 MΩ.

Input R
10M Auto

The Auto mode selects high impedance (Hi-Z) for the 200 mV, 2 V and **20 V*** ranges, and 10 MΩ for the 200 V and 1000 V ranges. In most situations, 10 MΩ is high enough to not load most circuits, but low enough to make readings stable for high impedance circuits. It also leads to readings with less noise than the (Hi-Z) option, which is included for situations where the 10 MΩ load is significant.

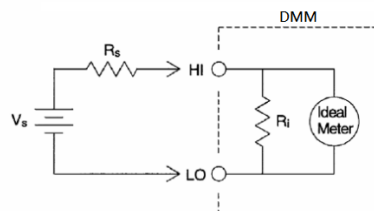

V_s = ideal voltage of DUT

R_s = input impedance of DUT

R_i = input impedance of GDM-9052 (either 10 M or 10 G available (Hi-Z))

$$\text{Deviation (\%)} = \frac{R_s}{R_s + R_i} * 100$$

Note

*The high impedance (Hi-Z) for the range of 20 V is only available when “Auto” is selected for Input R and also the function of F4 (Extend) key is activated.

F4 (Extend) key to Background activate Hi-Z under the range of 20 V



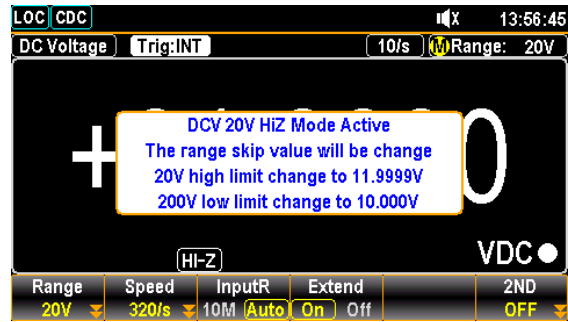

Turn On the Extend function to further activate the Hi-Z when the range is selected under 20 V, which will prompt the warning message where it indicates the 20 V high limit is changed to 11.9999 V due to the technical attribute of GDM-9052 hardware.



In addition, be aware that only when “Auto” is selected for the F3 (InputR) key and the function of F4 (Extend) key is activated, the Hi-Z can be enabled under the range of 20 V.

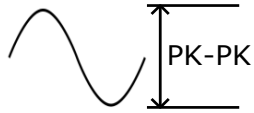
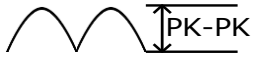

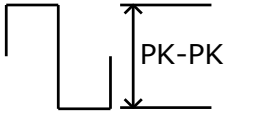

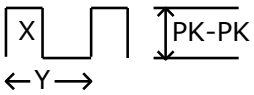
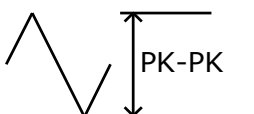

Voltage Conversion Table

Background This table shows the relationship between AC and DC reading in various waveforms.

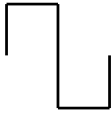
Waveform	Peak to Peak	AC (True RMS)	DC
Sine 	2.828	1.000	0.000
Rectified Sine (full wave) 	1.414	0.435	0.900
Rectified Sine (half wave) 	2.000	0.771	0.636
Square 	2.000	1.000	0.000
Rectified Square 	1.414	0.707	0.707
Rectangular Pulse 	2.000	$2K$ $K = \sqrt{(D - D^2)}$ $D = X/Y$	$2D$ $D = X/Y$
Triangle Sawtooth 	3.464	1.000	0.000

Crest Factor Table

Background Crest factor is the ratio of the peak signal amplitude to the RMS value of the signal. It determines the accuracy of AC measurement. If the crest factor is less than 3.0, voltage measurement will not result in error due to dynamic range limitations at full scale. If the crest factor is more than 3.0, it usually indicates an abnormal waveform as seen from the below table.

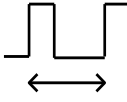
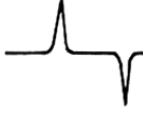
Waveform	Shape	Crest factor
Square wave		1.0
Sine wave		1.414
Triangle sawtooth		1.732
Mixed frequencies		1.414 to 2.0
SCR output 100 % to 10 %		1.414 to 3.0
White noise		3.0 to 4.0
AC Coupled pulse train		>3.0
Spike		>9.0

AC/DC Current Measurement

Background The GDM-9052 series DMMs have two input terminals for current measurement. A 2 A terminal for current less than 2 A and a 10 A terminal for measurements up to 12 A. The units can measure 0 to 10 A for both AC and DC current.

Current type GDM-9052 AC/DC 2 A/10 A

Activate ACI/ DCI Measure Press the Shift → ACV or Shift → DCV key to measure AC or DC current, respectively.

ACI/DCI mode display appears The measurement will switch to ACI, DCI mode immediately. See the figure below for example.

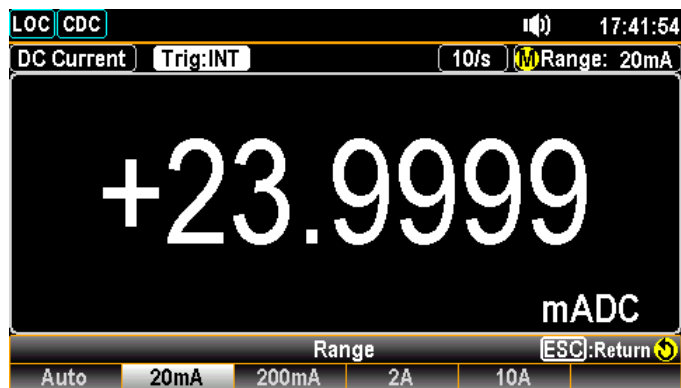

AC or DC Current	Indicates DC or AC Current mode
10 /s	Indicates the active refresh rate
A	Indicates Automatic range selection
Range: 20 mA	Indicates the available range of Current
+23.9999 mADC	Indicates the exact measured value

Connect the test lead and measure

Connect the test lead between the 2 A terminal and the Input LO terminal or DC/AC 10 A terminal and the Input LO terminal, depending on the input current.

The display updates the reading. For current ≤ 2 A use the 2 A terminal.

For current up to 12 A use the 10 A terminal.

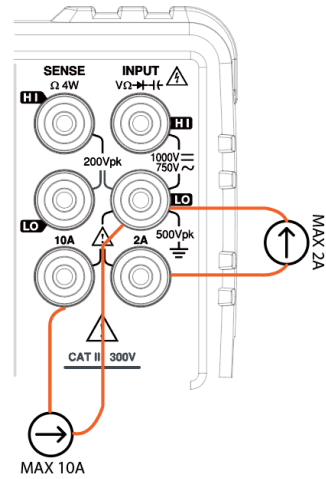

Select Current Range

Auto range

To turn the automatic range selection On/Off, press the AUTO key. The most appropriate range for the currently used input jack will be automatically selected. The GDM-9052 is able to do this by remembering the last manually selected range and using that information to determine the smallest current range that the auto-range function will switch to. When the current input is switched to another terminal, the range must be manually set.



⚠ Auto Range not allowed on 10 A

Manual range

Press the up or down arrow key to select the range. The AUTO indicator **A** turns to **M** indicating Manual range selection.

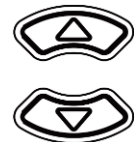

If the appropriate range is unknown, select the highest range.



You can also press F1 (Range) key to select a range for the measurement.

Press the F1 to F5 key to select a desired range for the measurement.



Selectable Current Ranges	Range	Resolution	Full scale	INJACK
	20 mA	100 nA	23.9999 mA	2 A
	200 mA	1 μ A	239.999 mA	2 A
	2 A	100 μ A	2.39999 A	2 A
	10 A	1 mA	11.9999 A	10 A

 **Note** For more detailed parameters, see the specifications on page 166.

General Current Setting

F2 (Speed) key to select the rate

DCI/ACI:



Press the F1 to F3 key to select the desired rate

Speed





2W/4W Resistance Measurement

Measurement type	2-wire OHM	Uses the standard Input HI-LO terminals. Recommended for measuring resistances larger than 1 k Ω .
	4-wire OHM	Compensates the test lead effect using the 4W compensation terminals (SENSE HI/LO terminals), in addition to the standard Input HI-LO terminals. Recommended for measuring sensitive resistances smaller than 1 k Ω .

Activate 2W Measurement	Press the Ω 2W key to activate 2W resistance measurement.	
	Press the Shift \rightarrow Ω 2W key to activate 4W resistance measurement.	 + 

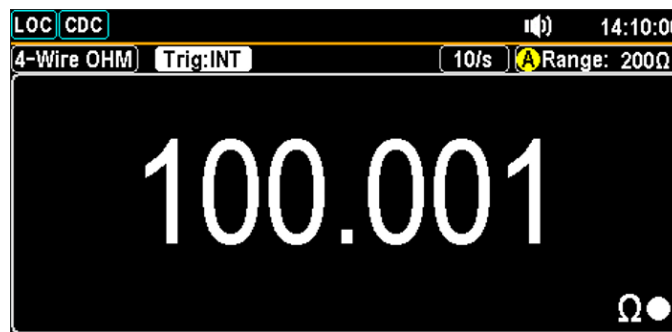
2W/4W resistance mode display appears The mode will switch to the selected resistance mode immediately. Press the Shift \rightarrow Ω 2W key on the front panel as figure shown below.



2 or 4-Wire OHM	Indicates 4W Resistance mode
10 /s	Indicates the active refresh rate
	Indicates Automatic range selection
Range: 200 Ω	Indicates the available range of Resistance
100.001 Ω	Indicates the exact measured value

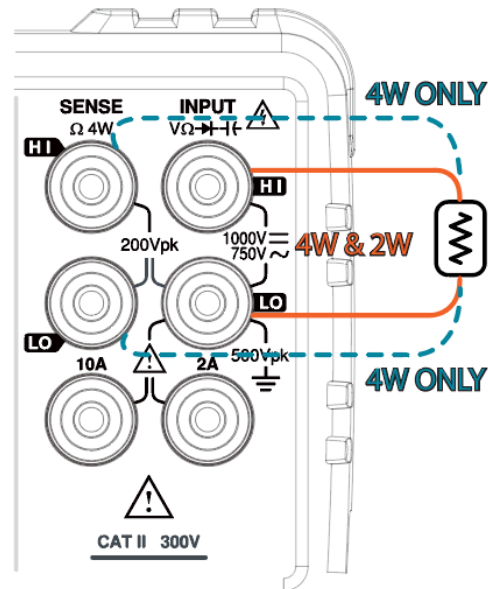

Connect the test lead and measure For 2W measurement, connect the test leads between the Input HI terminal and the LO terminal.

For 4W measurement, connect the test leads between the Input HI terminal and the LO terminal, as the way to 2W measurement. Also, connect another sense leads between the SENSE LO and HI terminals.



Select Resistance Range

Auto range To turn the automatic range selection On/Off, press the Auto key. 

Manual range Press the up or down arrow key to select the range. The Auto indicator **A** turns to **M** indicating Manual range selection. If the appropriate range is unknown, select the highest range. 

You can also press the F1 (Range) key to select a range for the measurement. 

Press the F1 to F5 key to select a desired range for the measurement.



Press the F6 (More 1/2) key for next page with more options as the figure shown below. 



Selectable Resistance Ranges	Range	Resolution	Full scale
	200 Ω	1 mΩ	239.999 Ω
	2 kΩ	10 mΩ	2.39999 kΩ
	20 kΩ	100 mΩ	23.9999 kΩ
	200 kΩ	1 Ω	239.999 kΩ
	2 MΩ	10 Ω	2.39999 MΩ
	10 MΩ	100 Ω	11.9999 MΩ
	100 MΩ	1 kΩ	119.999 MΩ

 **Note** For more detailed parameters, see the specifications on page 166.



General Resistance Setting

F2 (Speed) key to select the rate Press the F1 to F3 key to select the desired rate 





Continuity Test

Background The continuity test checks that the resistance in the DUT is low enough to be considered continuous (of a conductive nature).

Activate continuity test Press the  key to activate continuity testing. 

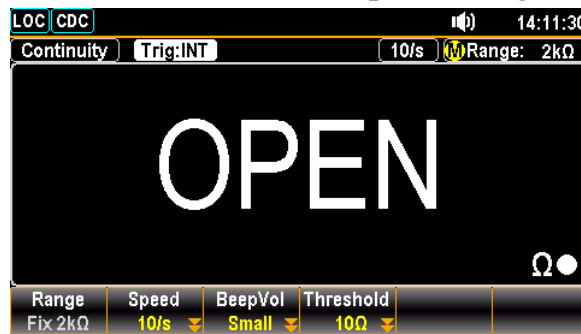
Continuity mode display appears The mode will switch to continuity testing immediately. Press  on the front panel as figure shown below.



Continuity	Indicates Continuity measurement
10 /s	Indicates the active refresh rate
	Indicates Manual range selection
2 kΩ	Indicates the available range of Continuity ⚠ Note: the range selection is fixed in 2 kΩ
OPEN Ω	Indicates the currently measured result

Connect the test lead and measure Connect the test lead between the Input HI terminal and the LO terminal. The display updates the reading.

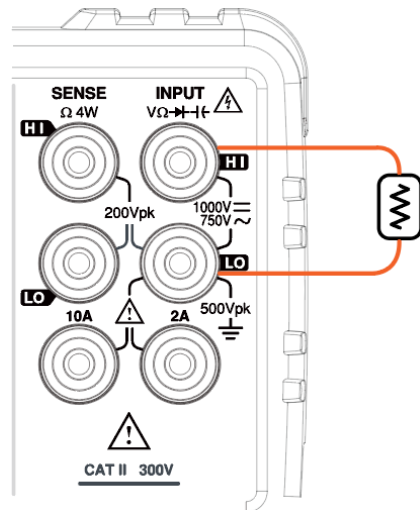

F2 (Speed) key to select the rate.

Press the F1 to F3 key to select the desired rate

Speed



F3 (BeepVol) key to select the Vol

Press the F2 to F4 key to select the volume level or press the F1 key to set Beep volume off

BeepVol



Set Continuity Threshold

Background

The continuity threshold defines the maximum resistance allowed in the DUT when testing the continuity.

Threshold Range

Threshold 1 Ω to 1000 Ω (Default Threshold:10 Ω)

Resolution 1 Ω

Procedure

Press the F4 key to enter the Threshold of Continuity menu as the figure below shown.

Threshold



Set the continuity threshold level.

1. Use the Arrow keys or press Number keys to designate a desired value.
2. Press the Enter key to confirm the set value for threshold setting.





Display





Diode Measurement

Background The diode test checks the forward bias characteristics of a diode by running a constant forward bias current of approximately 1mA through the DUT.

Activate diode test Press the  key to activate diode measurement. 

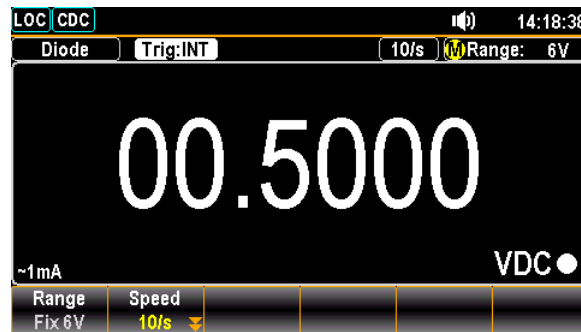
Diode mode display appears The screen will switch to Diode mode immediately as the figure shown below.



Diode	Indicates the Diode measurement
10 /s	Indicates the active refresh rate
	Indicates Manual range selection
6 V	Indicates the available range of Diode ⚠ Note: the range selection is fixed in 6 V
00.5000 VDC	Indicates the exact measured value

Connect the test lead and measure Connect the test lead between the Input HI terminal and the LO terminal; Anode-V, Cathode-COM. The display updates the reading.

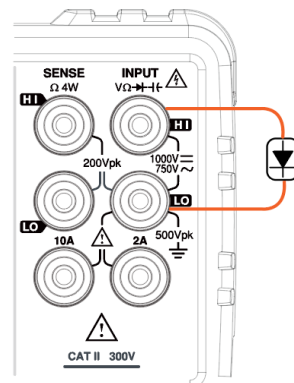

F2 (Speed) key to select the rate. Press the F1 to F3 key to select the desired rate



Frequency/Period Measurement

Description The GDM-9052 can be used to measure the frequency or period of an input signal.

Range	Frequency	10 Hz to 1 MHz
	Period	1.0 μ s to 100 ms

Activate frequency or period test

- To measure Frequency, press the **FREQ** key followed by clicking the **F3 (Measure)** key to enter the Measure menu. Click the **F1 (Frequency)** key and the measured frequency will be displayed on the primary screen with the period value displayed on the sub section beneath.



- To measure Period, press the **FREQ** key followed by clicking the **F3 (Measure)** key to enter the Measure menu. Click the **F2 (Period)** key and the measured period will be displayed on the primary screen with the frequency value displayed on the sub section beneath.



Display

Frequency Mode

Indicator Frequency Mode

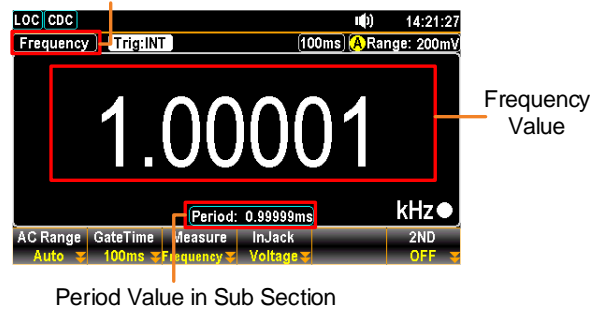

Period Value in Sub Section

Period Mode

Indicator Period Mode

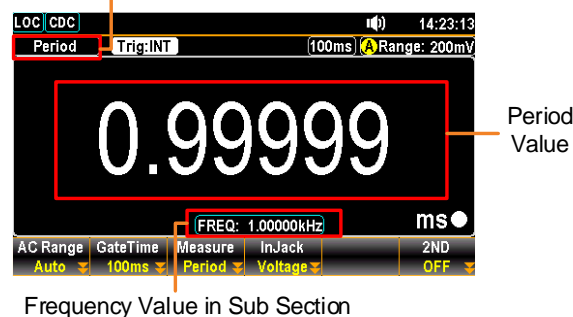

Frequency Value in Sub Section

Frequency mode display appears The mode will switch to the Frequency or Period mode immediately. Press  on the front panel followed by clicking F3 key to choose Frequency as shown below.

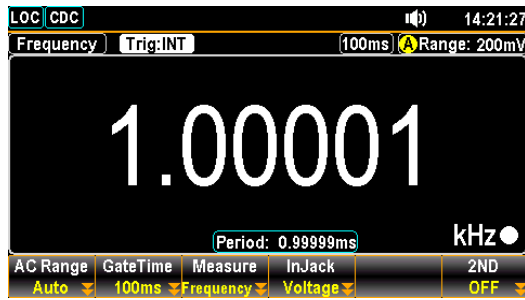

Frequency	Indicates Frequency measurement
100 ms	Indicates the active refresh rate
	Indicates Auto range selection
200 mV	Indicates the available range of Voltage
1.00001 kHz	Indicates the exactly measured Frequency value
0.99999 ns	Indicates the exactly measured Period value

Connection Depending on different inputs, connect test lead to varied terminals. In terms of voltage, connect test leads between the Input HI terminal and the LO terminal. The display updates the reading.

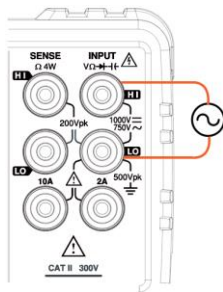

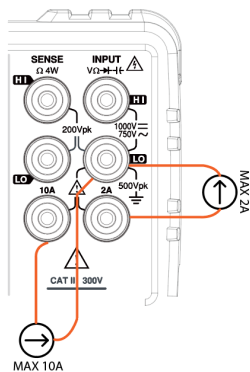

In terms of current, connect test leads between the 2 A terminal and the LO terminal or DC/AC 10 A terminal and the LO terminal. The display updates the reading.



Frequency/Period In-Depth Setting

Background The input voltage/current range for frequency/period measurements can be set to Auto range or to manual. By default, the voltage/current range is set to Auto for both the period and frequency.

Auto range Press the Auto key. Auto  will be displayed on the upper right corner. 

F2 (Gate Time) key to select gate time **Background** It is the threshold to recalculate frequency/period. Slower the gate time, e.g., 1 s, more accurate the reading value.

Press the F2 key to enter gate time menu. Click the F1 – F3 key for the desired gate time. See the figure below with available options. 



F4 (InJack) key to select voltage or current **Background** In accordance with the target inputs, choose the corresponding selection per condition. E.g., select “2 A” when the input current is below 2 A amplitude.

Press the F4 (InJack) key to determine whether the voltage or current 2 A or current 10 A to be measured. Press the F1 – F3 key to select desired option. See the figure shown below with options available. 



F1 (AC Range) key to manually select range setting

Press the up or down arrow key to select desired range. The Auto indicator **A** turns to **M** indicating Manual range selection. If the appropriate range is unknown, select the highest range.



You can also press the F1 (AC Range) key to select a range for the measurement. Depending on the InJack setting, the available options vary. See examples below.



When InJack is Voltage:

Press the F1 to F6 key to select a desired range for the measurement.



When InJack is 2A:

Press the F1 to F4 key to select a desired range for the measurement.





When InJack is 10A:



Press the F1 to F2 key to select a desired parameter for the measurement.





Capacitance Measurement

Background The capacitance measurement function checks the capacitance of a component.

Activate capacitance test Press the Shift → **FREQ** to activate capacitance measurement.  + 

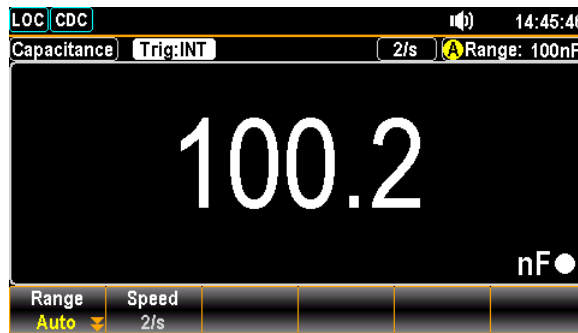
Capacitance mode display appears The screen will switch to capacitance mode immediately. Press  +  on the front panel as shown below.



- Capacitance Indicates the Capacitance measurement
- 2 /s Indicates the active refresh rate
 Note: refresh rate of Capacitance is fixed in 2 /s.
-  Indicates Automatic range selection
- Range: 100nF Indicates the available range of Capacitance
- 100.2 nF Indicates the exact measured value

Connect the test lead and measure Connect the test lead between the Input HI terminal and the LO terminal; Positive-HI, Negative-LO. The display updates the reading.

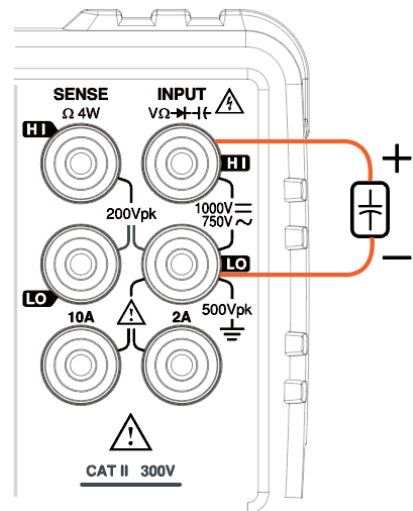

Cable Open Function

Background Cable open function will be activated when capacitance range is in 10 nF. It is required to proceed to Cable Open function when capacitance is in 10 nF in which test leads connected will result in measuring capacity in small scale.

Display

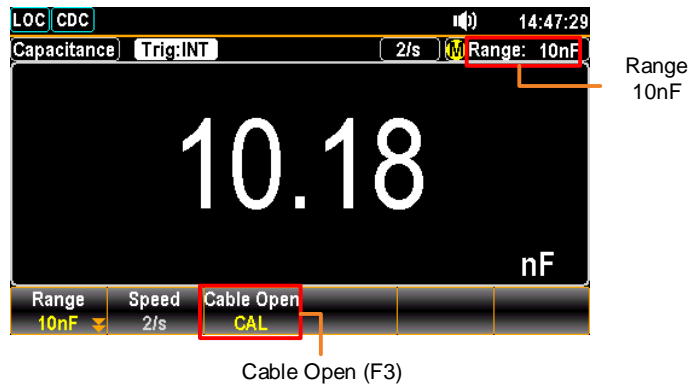

Activate cable open function Connect test leads followed by pressing the F3 (Cable Open) key to proceed to Cable Open function. The measured value will be rectified and returned to zero as the figure shown below.

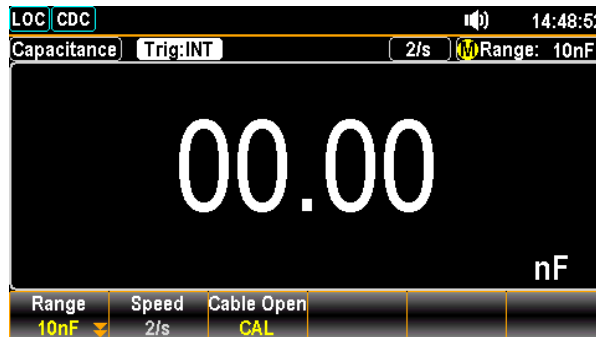



Connect the test lead and measure Follow the connection method of capacitance measurement to measure and obtain precise-prone value.

 **Note**

Except for 10 nF, all are Not applicable to Cable Open function.

Select Capacitance Range

Auto range To turn the automatic range selection On/Off, press the Auto key. 

Manual range Press the up or down arrow key to select desired range. The Auto indicator **A** turns to **M** indicating Manual range selection. If the appropriate range is unknown, select the highest range.  

You can also press the F1 (Range) key to select a  range for the measurement.

Press the F1 to F6 key to select a desired range for the measurement.



Selectable Capacitance Ranges	Range		
	Range	Resolution	Full scale
	10 nF	10 pF	11.99 nF
	100 nF	100 pF	119.9 nF
	1 µF	1 nF	1.199 µF
	10 µF	10 nF	11.99 µF
	100 µF	100 nF	119.9 µF



 **Note** For further details, please see the specifications on page 166.

 **Note** The refresh rate settings cannot be used in the capacitance mode.

Temperature Measurement

Background The GDM-9052 can measure temperature utilizing Thermocouple devices. To measure temperature, the GDM-9052 accepts a device input and calculates the temperature from the voltage fluctuation.

Temperature Range Thermocouple -200 °C to +300 °C, Type: J, K, T

Activate temperature measurement Press the Shift +  key to activate temperature measurement.  + 

Temperature mode display appears

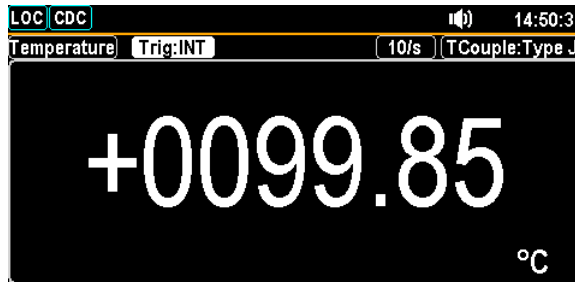

Temperature Indicates Temperature measurement

+ 0099.85 °C Indicates the exact measured value

T Couple Indicates the active Probe

Type J Indicates the active Type

Connect the test lead and measure

Connect the sensor lead between the Input HI terminal and the LO terminal. The display updates the reading.

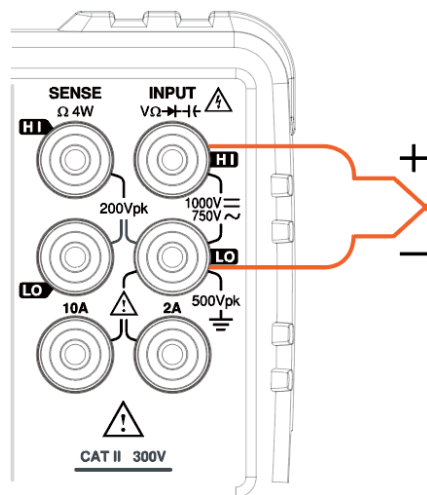

General Temperature Setting

F2 (Speed) key to select the rate Press the F1 to F3 key to select the desired rate

Speed



F3 (Unit) key to select unit of temperature Press the F4 (Unit) key to enter the Temperature Unit menu followed by clicking the F1 – F2 key to choose desired temperature unit. See the figure shown below.

Unit



Thermocouple Sensor Type

Background The GDM-9052 accepts thermocouple inputs and calculates the temperature from the voltage difference of two dissimilar metals. Thermocouple sensor type is one of the main factors to be considered.

Parameter	Thermocouple Sensor Type	Measurement Range	
	J	-200 to +300 °C	0.01 °C
	K	-200 to +300 °C	0.01 °C
	T	-200 to +300 °C	0.01 °C

Reference Junction Temperature (SIM Temperature)

Background
(Thermocouple
only)

When a thermocouple is connected to the GDM-9052, the temperature difference between the thermocouple lead and the GDM-9052 input terminal should be taken into account and be cancelled out; otherwise, an erroneous temperature might be added. The value of the reference junction temperature should be determined by the user.

Type	Range	Resolution
SIM	0 °C to 50 °C (default: 23.00 °C)	0.01 °C

Thermocouple Setting

- Procedure 1. Press the F4 (Type) key **Type** to enter the Sensor Type menu as the figure shown below. Click the F1 – F3 key to select a desired sensor type per situations.



2. Further press the F5 (Simulated) key **Simulated** after returning to the previous menu page. You can input a desired parameter as the following figure (+23 for example) for the so-called "Reference Junction Temperature".



A.I. (Auto Identification) Measurement

Background The GDM-9052 can identify the connected sources and switch to the corresponding measurements automatically, which allows user to operate the unit in a more friendly manner with ease.

Applicable measurement	ACV	DCV	2W	Diode	Continuity
	●	●	●	●	●

- Step**
1. Press and hold the physical Enter key for 2 seconds to activate the A.I. function. The icon of A.I., which appears in orange background signifying auto identification is underway, on the upper status bar pops up accordingly.



(Press & hold for 2 seconds)

The A.I. function is identifying source

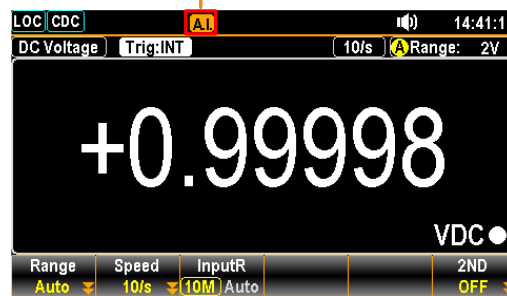

2. After the auto identification is finished, the A.I. icon becomes in green background, which represents that the A.I. function is in Standby mode and ready for next identifying of connected source.

The A.I. function is in Standby mode



DUAL MEASUREMENT



Dual Measurement	57
Refresh Rate	60
Connect the Test Leads	61
The error influence on Dual Measurement (V & I)	63
The error of current shunt	64

Dual Measurement

Background

The dual measurement mode allows you to use the 2nd display to show another item, thus viewing two different measurement results at once.

When the multimeter is used in dual measurement mode, both displays are updated from either a single measurement or from two separate measurements. If the primary and secondary measurement modes have the same range, rate and rely on the same fundamental measurement, then a single measurement is taken for both displays; such as ACV and frequency/period measurements. If the primary and secondary displays use different measurement functions, ranges or rates, then separate measurements will be taken for each display. For example, ACV and DCV measurements.

Most of the basic measurement functions, except for temperature/continuity/diode/capacitance can be used in the dual measurement mode.

The following table shows the available measurement combinations.

Primary Display	Secondary Display					
	ACV	DCV	ACI	DCI	Hz/P	Ω
ACV	●	●	●	●	●	X
DCV	●	●	●	●	X	X
ACI	●	●	●	●	●	X
DCI	●	●	●	●	X	X
Hz/P	●	X	●	X	●	X
Ω	X	X	X	X	X	●

Note

When two different measurements are taken, there is a switching delay between the first measurement and the second measurement.

1st Measurement item setting

Choose one of the basic measurement functions from the table above to set the measurement mode for the primary display.



For example, press DCV to set the first display to DCV measurement.

2nd Measurement item setting

To set a measurement mode for the second display, press the F6 (2ND) key and the 2ND Function options appear subsequently.



For example, press the F3 (ACV) key to select ACV measurement for the second display.

Display

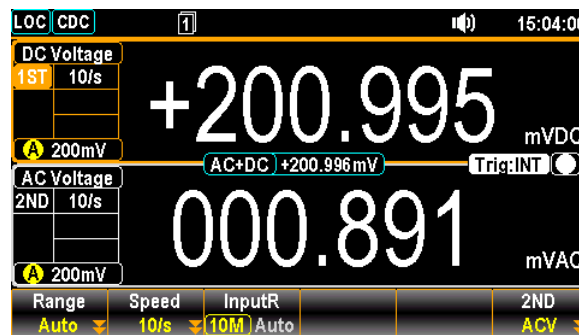

1ST Display Shows the DCV measurement

2ND Display Shows the ACV measurement





1ST in orange Indicates that 1ST display is the currently active display.

Editing 1st or 2nd measurement item settings

After the secondary measurement function has been activated, the rate, range and measurement item can be edited for either the primary or secondary display.

Note, however, it is more practical to configure the first or second measurement items before activating dual measurement mode.

To edit measurement parameters in dual measurement mode, you must first set which display is the active display. The orange outline covering either 1ST or 2ND icon indicates the active display.

1. Select active display	<p>Toggle the active display between the 1ST and 2ND display by long pressing the Shift key for 2 seconds:</p> <p>Primary display: 1ST highlighted in orange outline.</p> <p>Secondary display: 2ND highlighted in orange outline.</p>	 <p>(Press & hold for 2 seconds)</p>
Display	<p>1ST in active display: </p> <p>2ND in active display: </p>	
2. Edit active display settings	<p>Edit the range, rate or measurement item for the active display in the same way as for single measurement operation. See the Basic Measurement on page 25 for details.</p>	
Turn Off 2nd Measurement	<p>To turn Off the 2ND measurement, first toggle in 1ST active display followed by pressing the F6 (2ND) key. Click the F6 (OFF) key again to disable the 2ND measurement.</p>	

Refresh Rate

Background Refresh rate defines how frequently the GDM-9052 captures and updates measurement data. A faster refresh rate yields a lower accuracy and resolution. A slower refresh rate yields a higher accuracy and resolution. Consider these tradeoffs when selecting the refresh rate.

Measurement Type	Refresh Rate		
DCV/DCI	10 /s	40 s	320 /s
ACV/ACI	10 /s	40 /s	320 /s
Frequency/Period	1 s	100 ms	10 ms

- Selection steps**
1. Toggle the active display between the 1ST and 2ND display by long pressing the Shift key for 2 seconds:

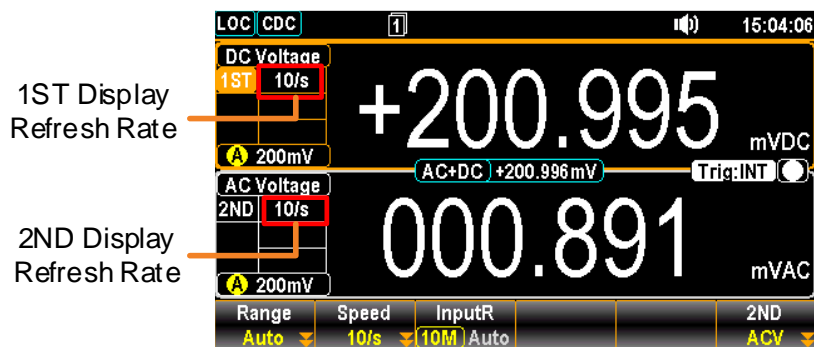

 (Press & hold for 2 seconds)
 2. Press the F2 (Speed) key to select a desired rate for measurement.

 3. The refresh rate will be shown at the left side of each display. See the figure below shown.

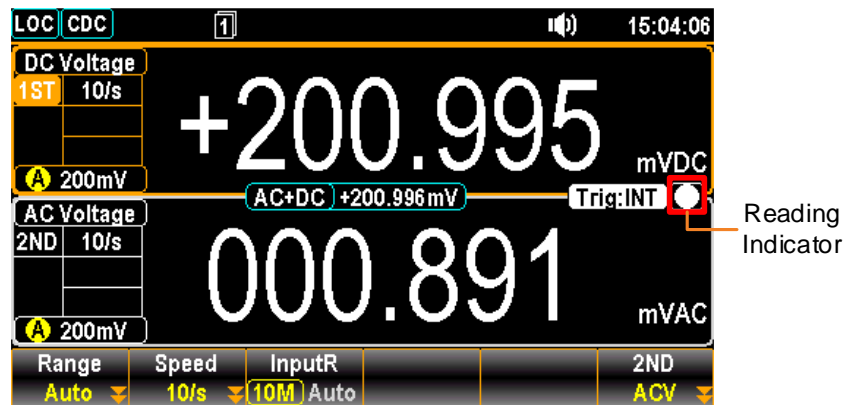

Reading Indicator

The reading indicator  flashes according to the defined refresh rate setting of the active display.



Connect the Test Leads

Connect the test leads and measure

When using the dual measurement function, the connection method and number of test leads required depends on the measurement combination. Use the connect diagrams below as guide when taking dual measurements.

Voltage and Frequency/Period Measurement

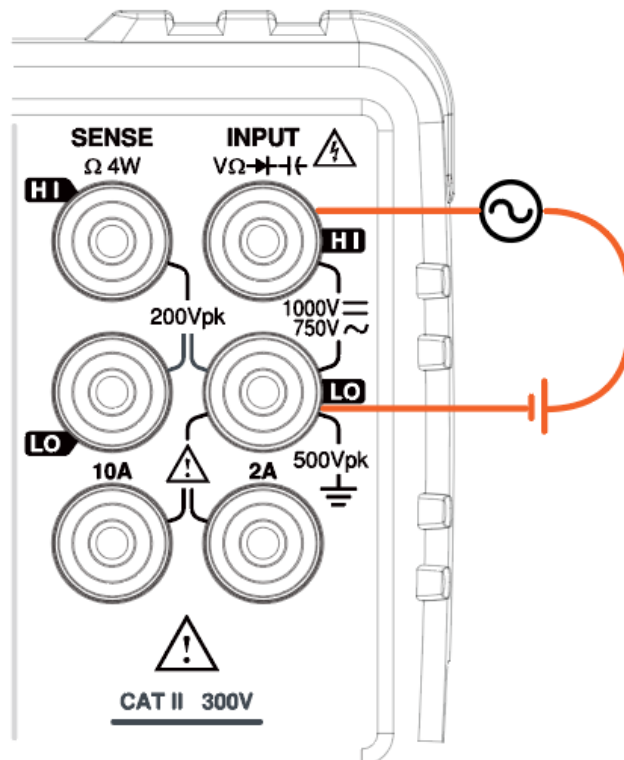

Voltage/Frequency/
Period and Current
Measurement

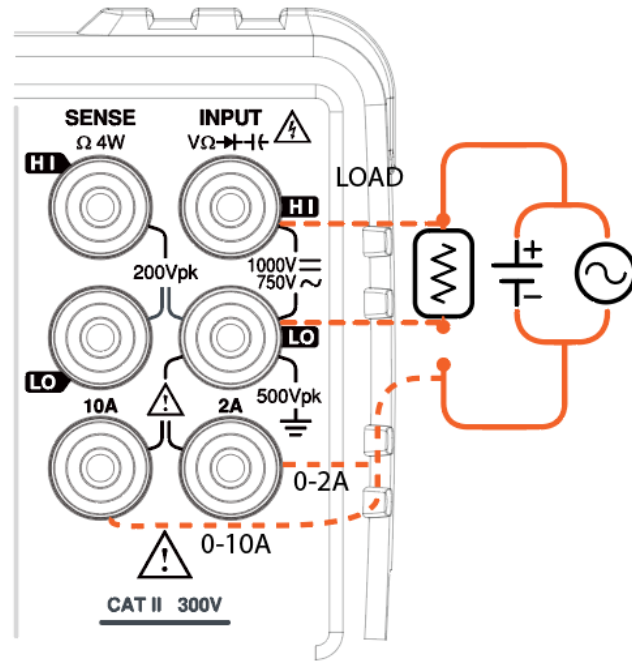

 Note

DC Current measurements will be displayed as a negative value as the polarity of the current leads has been reversed.

Please take into account the resistance of the test leads and internal resistance of the current connection as it is in series with the test circuit.

The above measuring configuration is used to measure the voltage present on the resistance under test and the current through the resistance under test when using the DCI/DCV or ACI/ACV dual measurement function.

When dual measurement (DCI/DCV or ACI/ACV) is underway, the input impedance will change, thus resulting in load deviation due to the fluctuation of different measuring range.

The error influence on Dual Measurement (V & I)

Background

While dual measurement of voltage and current is being executed, the route from DMM internal circuit to the LO terminal circuit for measuring voltage is totally identical with that for measuring current, and thus the resistor within the route is commonly shared by the two measuring circuits. While measuring current, the resistor within the circuit will generate a voltage drop. When the internal resistor of LO terminal is added to the external load resistor within the circuit, the accuracy of voltage reading will be influenced.

Diagram

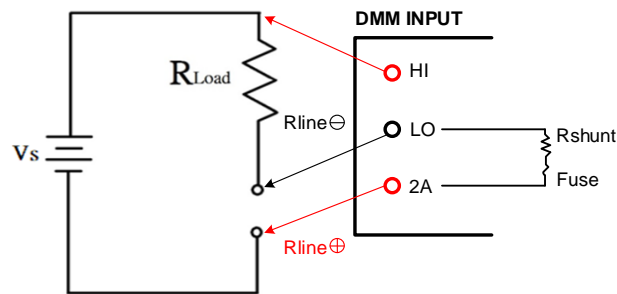

Example

V_s = Voltage source

R_{Load} = Load under test

R_{int} = Current terminal total impedance containing $R_{shunt} + Fuse + R_{line\oplus} + R_{line\ominus}$

When different current range for measurement is selected, R_{shunt} will vary accordingly.

For example,

$V_s = 10\text{ V}$, $R_{Load} = 10\ \Omega$, $V_s = 10\text{ V}$, $R_{Load} = 10\ \Omega$

If the total impedance passing through current terminal is $R_{int} = 0.5\ \Omega$, the ideal measured voltage will be 10 V regardless of impact on load from voltmeter input impedance. The calculation for actual

measured value is $10\text{ V} * \frac{10\ \Omega}{(10\ \Omega + 0.5\ \Omega)} = 9.5238\text{ V}$.

Error (%) = $\frac{R_{int}}{(R_{Load} + R_{int})} * 100$, this error is applicable to not only DC but AC measurement as well. The influence will be probably more serious depending on varied actual conditions.

The error of current shunt

Background

The principle of current measuring is to obtain current via the voltage proportionated by the measured shunt resistor and the current under test. The circuit is basically designed by high impedance (0.01Ω to 1Ω approximately) and with shortcoming of voltage drop by shunt. There will be obvious error occurred while measuring low current due to the measurable voltage generated by a larger shunt.

An ideal ammeter never changes flowing route of current, and thus it owns the characteristics of both zero-input resistor and zero-input voltage drop. In practice, however, ammeter always generates an input voltage drop while measuring, which is known as burden voltage in series.

Diagram

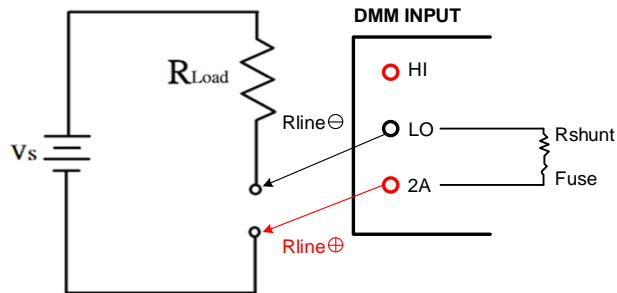

Example

V_s = Voltage source

R_{Load} = Load under test

R_{int} = Current terminal total impedance containing
 $R_{shunt} + Fuse + R_{line}^{\oplus} + R_{line}^{\ominus}$

When different current range for measurement is selected, R_{shunt} will vary accordingly.

For example,

$V_s = 10\text{ V}$, $R_{load} = 10\ \Omega$, $R_{int} =$ total impedance flowing through current terminal $0.5\ \Omega$

The theoretical value for current reading should be

$I = \frac{V_s}{R_{load}} = 1\text{ A}$ in that the DMM internal resistor R_{int} , which contains Shunt, R_{line}^{\oplus} , R_{line}^{\ominus} and Fuse, will cause impact on the measuring reading.

The measured value is $I = \frac{V_s}{(R_{load} + R_{int})} = \frac{10\text{V}}{(10\Omega + 0.5\Omega)} = 0.95238\text{ A}$.

$$\text{Error (\%)} = \frac{R_{int}}{(R_{load} + R_{int})} * 100$$

This error is applicable to not only DC but AC measurement, and the burden voltage, per varied current measuring range, is generally within the range of several hundreds mV.

	Range	Shunt	Burden Voltage
DC Current	20 mA	1 Ω	0.14 VMax.
	200 mA	0.1 Ω	1.41 VMax.
	2 A	10 m Ω	0.5 VMax.
	10 A	10 m Ω	0.8 VMax.

The above table indicates the maximum burden voltage caused by the maximum current within the applicable range.

ADVANCED

MEASUREMENT



Advanced Measurement Overview	67
Relative Value Measurement	68
Hold Measurement	70
Trigger Setting	72
Automatic/Single Triggering	72
Use External Trigger	73
Filter Setting	75
Digital Filter Overview	75
Digital Filter Setting	77
Math Measurement	78
dBm/dB/Watt Measurement	78
Compare Mode	85
MX+B Measurement	88
1/X Measurement	90
Measure Percent	92

Advanced Measurement Overview

Background Advanced measurement mainly refers to the type of measurement which uses the result obtained by one of the basic measurements: ACV, DCV, ACI, DCI, 2W, 4W, Diode/Continuity, Frequency/Period, and Temperature.

Advanced Measurement	Basic Measurement						
	AC/DCV	AC/DCI	2W/4W	Hz/P	TEMP	→+/(•))	+±
Relative	●	●	●	●	●	—	—
Hold	●	●	●	●	●	—	—
Trigger	●	●	●	●	●	●	—
Filter	●	●	●	●	●	—	—
dB	●	—	—	—	—	—	—
dBm	●	—	—	—	—	—	—
Compare	●	●	●	●	●	—	●
MX+B	●	●	●	●	●	—	—
1/X	●	●	●	●	●	—	—
Percent	●	●	●	●	●	—	—

Relative Value Measurement

Applicable to **8 ACI** **7 DCI** **9 Ω4W** **4 $\frac{1}{f}$** **5 TEMP**
 ACV DCV Ω2W FREQ \rightarrow

Background Relative measurement stores a value, typically the data at the moment, as the reference. The following measurement is shown as the delta between the references. The reference value will be cleared upon exit.

REL, basically, is to subtract a certain value in the following measurement. The value is fixed and remains its effect even user exits and returns back to this function again.

One of the most seen purposes of REL is to eliminate impedance of test lead from measurement. Before operating impedance measurement, short circuit the test lead followed by pressing the [REL] button. For other measurements, press the [REL] button after putting test lead in a null circuit.

Alternatively, user can modify the value by pressing the [REL#] button followed by using the knob or number keys to enter a specified value. Press the [REL] button again to disable null operation.

Activate Relative measurement Press the REL key. The measurement reading at the moment becomes the reference value.



Relative measurement display appears

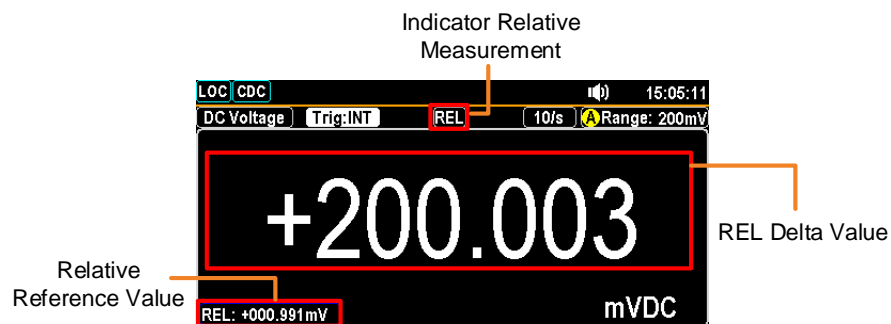

REL Indicates Relative value measurement

REL: 000.991 mV Shows the stored reference value

+049.99

Shows the delta between the current measurement data and the reference value

Manually set the reference value

To set the reference (REL) value manually, press the Shift key followed by the REL key. The setting appears.

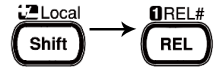

First use function keys to decide unit value. Then use the Left/Right arrow keys to move cursor and Up/Down arrow keys or press Number keys to enter the desired value.



Press the F6 (Enter) key or the physical Enter key to confirm the relative value setting.



Deactivate Relative measurement

To cancel the Relative measurement, press the REL key again, or simply activate another measurement.



Hold Measurement

Applicable to **8 ACI** **7 DCI** **9 Ω4W** **4 $\frac{1}{f}$** **5 TEMP**
 (ACV) (DCV) (Ω2W) (FREQ) (→+)

Background The Hold Measurement function retains the current measurement data and updates it only when it exceeds the set threshold (as a percentage of the retained value).

Activate Hold measurement Press the Hold key to activate Hold measurement. 

Hold measurement display appears

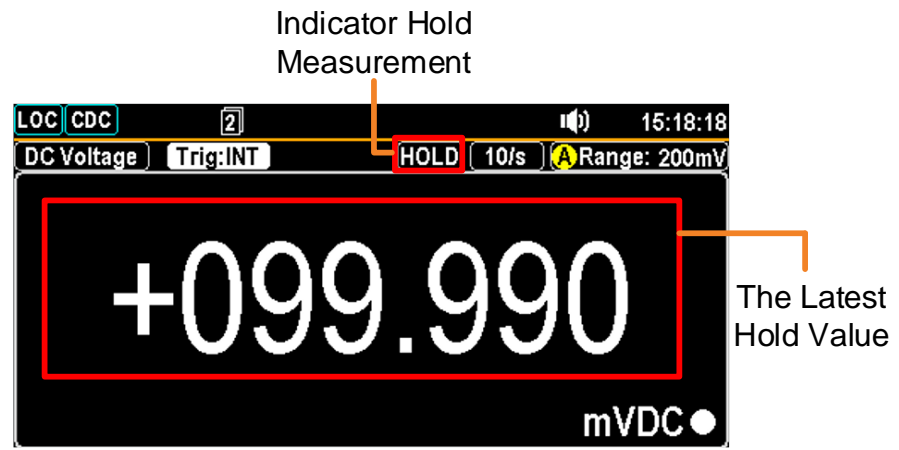

Hold Indicates Hold measurement

+099.990 mVDC Shows the latest hold value

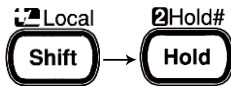
Enter hold settings Press the Shift + Hold key to activate detailed setting menu of Hold mode as the figure below. 



F2 (BeepVol) key to define beep volume Press the F2 (BeepVol) key to show the menu of Volume level of Beep as the following. 



Press the F2 - F4 key to select volume level. Once the latest hold value is updated, the beep sounds based on the defined volume. Press the F1 key to set Beep volume off.

F3 (Percent)
key to define
threshold

Press the F3 (Percent) key to show the setting menu of Hold Percent as the figure below.

Percent



Press F1 to F4 key to select desired hold percent. For example, once the measured value is beyond 10 %, which corresponds to the selected 10 % option here, the latest hold value will be updated on the main reading.

F6 (HoldValue)
key to restart

Press the F6 (HoldValue) key to simply Restart the hold value.

HoldValue



Trigger Setting

Automatic/Single Triggering

Applicable to 8 ACI 7 DCI 9 Ω4W 6 4 5 TEMP
ACV DCV Ω2W ..) FREQ →

INT (Auto) triggering (default) By default, the GDM-9052 triggers according to the refresh rate automatically. See the previous page for refresh rate setting details. The figure below shows the screen of INT (Auto) Trigger measurement.

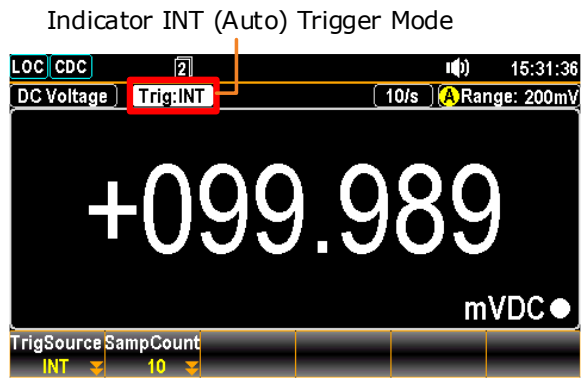

SIN (Manual) Triggering Press the TRIG key to SIN (Manual) trigger measurement. See below for details.

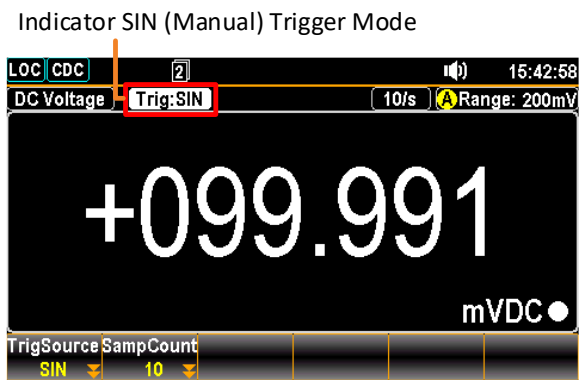

- Change mode**
- Under SIN (Manual) Trigger mode, press and hold the TRIG button for at least 2 second to return to INT (Auto) Trigger mode.
 - Under INT (Auto) Trigger mode, simply press the TRIG button to return to SIN (Manual) Trigger mode.



Use External Trigger

Background The GDM-9052 uses the internal trigger, by default, to count the frequency and the period. On the other hands, using an external trigger allows customized triggering conditions.

Signal connection Connect the external trigger signal to the Digital I/O port located on the rear panel.

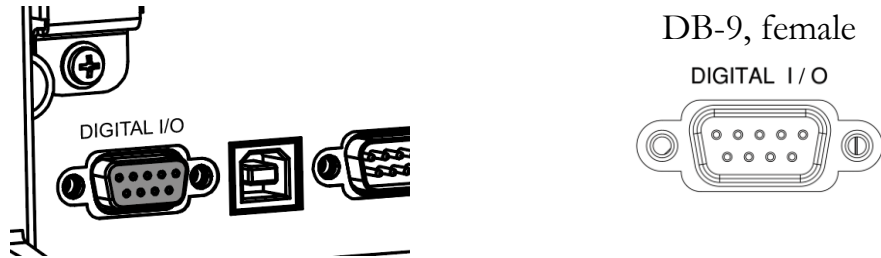

Digital I/O pin assignment

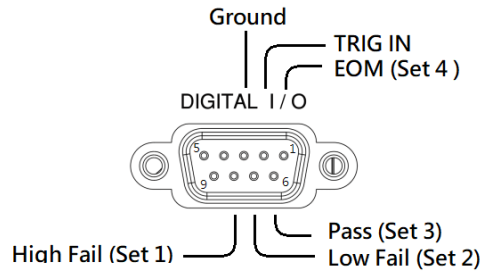

Activate external trigger

Press the Shift + TRIG key to activate setting menu of trigger.

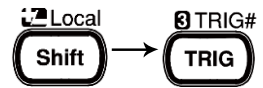

Press the F1 (TrigSource) key to enter the trigger source menu followed by pressing the F3 (EXT) to select External Trigger mode.



The "EXT" indicator appears on the display.

External Trigger Mode

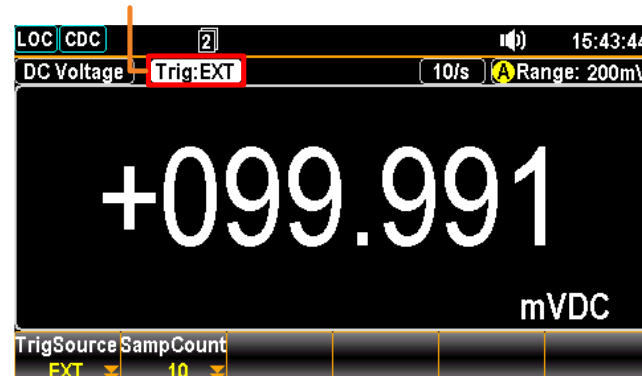

Set sample count

1. Under the setting menu of trigger, press the F2 (SampCount) key to enter the ensuing setting of Sample Count. Use the Left/Right arrow keys to move cursor and Up/Down arrow keys or press Number keys to enter the desired value.
2. Press the F6 (Enter) key or the Physical Enter key to confirm the SampCount settings.



Enter or



Reading indicator

The reading indicator  does not flash before triggering (can be on or off). After triggering, the indicator flashes according to the external signal trigger timing.

Exit external trigger

Press the F1 (TrigSource) key to reenter the TrigSource menu followed by pressing the F1 (INT) or the F2 (SIN) key to switch to other trigger modes.



Alternatively, it is viable to simply click the TRIG button to change to Trig:SIN mode or click and hold the TRIG button for 2 seconds to enter the Trig:Auto mode.

Filter Setting

Digital Filter Overview

Applicable to

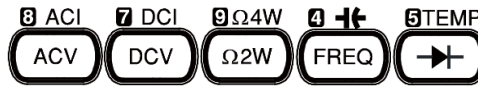

Filter basics

The GDM-9052 internal digital filter converts the analog input signal into digital format before passing it to internal circuits for processing. The filter affects the amount of noise included in the measurement result.

Filter type

The digital filter averages a specific number of input signal samples to generate one reading. The filter type defines the averaging method. The following diagrams highlight the differences between the Moving and Repeating filter using 4 samples per reading.

Moving (default)

The Moving filter takes in one new sample and discards the oldest sample per reading. This is the default behavior when the digital filter is not specified, and is recommended for most applications.

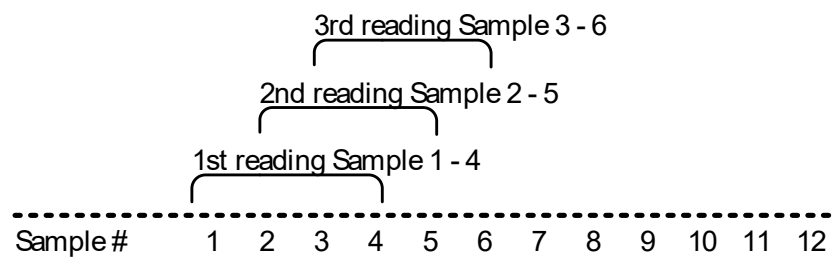

Repeating

The Repeating filter renews a whole group of samples per reading.

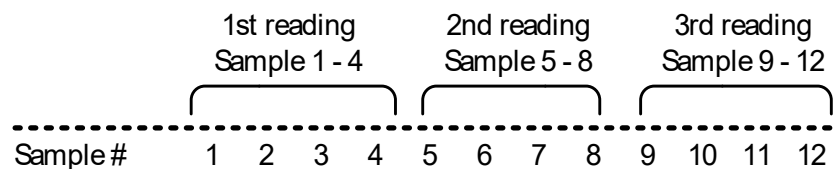

Filter count Filter count defines the number of samples to be averaged per reading. More samples offer low noise but a long delay. Less samples offer high noise but a short delay.

Range 2 to 320

Filter window Filter window defines the threshold for when the digital filter data is updated again. When the AD data falls in the range between TH and TL, the filter keeps processing. When the AD data falls out of the range between TH and TL, the filter will restart. When measuring unstable signals, appropriately setting the filter window can improve the measurement speed.

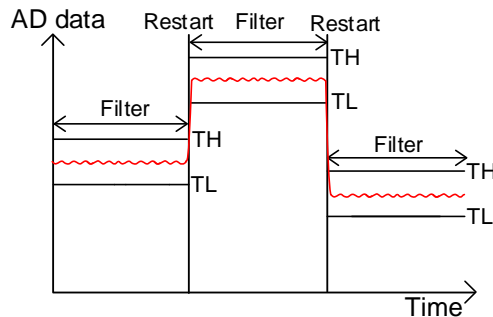

TH: Threshold High, TL: Threshold Low

Filter window Formula

Measure:

$$\text{Previous Meas} * (1 - \text{window}) < \text{threshold} < \text{Previous Meas} * (1 + \text{window}).$$

Range:

$$\text{Previous Measure} + (\text{Range} * \text{window}) < \text{threshold} < \text{Previous Measure} + (\text{Range} * \text{window})$$

There are 5 windows range settings that can be chosen: 10 %, 1 %, 0.1 %, 0.01 % and none

Digital Filter Setting

Filter setting Press the Shift + Filter keys. The Filter setting menu will be shown as the figure below.

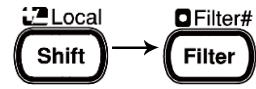

Choose Filter Type Press the F1 (FilterType) key to enter the subsequent menu. Press the F1 or F2 keys to select desired filter type.



Define Filter Count Press the F2 (FilterCount) key to enter the subsequent menu. Use the Left/Right arrow keys to move cursor and Up/Down arrow keys or press Number keys to enter the desired value. Press the F6 (Enter) key or the Physical Enter key to confirm the filter count settings.



Enter or



Range: 2 to 320



Define Filter Window Press the F3 (Window) key to enter the subsequent menu. Press the F1 – F5 keys to choose desired Filter Window percentage.



Range 0.01 %, 0.1 %, 1 %, 10 %, None

Turn On/Off Filter Press the Filter key to toggle between On and Off the Filter function. When it is turned On, the Filter indicator appears on the display.



Filter function indicator

Indicator Filter function

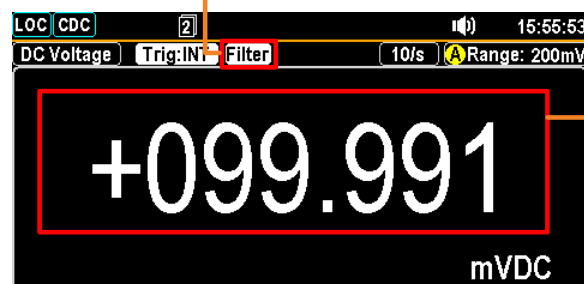

The filtered value



Math Measurement

Applicable to		
Background	Math measurement runs 6 types of mathematical operations, dBm, dB, Compare, MX+B, 1/X and Percent, based on the other measurement results.	
Math Equation	dBm	$10 \times \log_{10} (1000 \times V_{\text{reading}}^2 / R_{\text{ref}})$
	dB	$\text{dBm} - \text{dBm}_{\text{ref}}$
	Compare	Checks and updates if measurement data stays between the specified upper (high) and lower (low) limit.
	MX+B	Multiplies the reading (X) by the factor (M) and adds/subtracts offset (B).
	1/X	Divides 1 by the reading (X).
	Percentage	Runs the following equation. $\frac{(\text{ReadingX} - \text{Reference})}{\text{Reference}} \times 100 \%$

dBm/dB/Watt Measurement

Applicable to		
Background	Using the ACV or DCV measurement result, the GDM-9052 calculates the dBm, dB or Watt value based on a reference resistance value in the following way.	
Equation	dBm	$10 \times \log_{10} (1000 \times V_{\text{reading}}^2 / R_{\text{ref}})$
	dB	$\text{dBm} - \text{dBm}_{\text{ref}}$
	Watt	$V_{\text{reading}}^2 / R_{\text{ref}}$
Parameters	Vreading	Input Voltage, ACV or DCV
	Rref	Reference resistance simulating an output load
	dBmref	Reference dBm value

Measure dBm/Watt

Applicable to	 
Equation	dBm $10 \times \log_{10} (1000 \times V_{\text{reading}}^2 / R_{\text{ref}})$
	Watt $V_{\text{reading}}^2 / R_{\text{ref}}$
Parameters	Vreading Input Voltage, ACV or DCV
	Rref (REF Ω) Reference resistance simulating an output load

Activate dBm Press the Shift key + Math key to activate Math setting menu as the following figure shown.

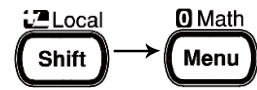

Further press the F1 (Function) key to enter the Math Function menu as the figure shown below.



Press F3 (dBm) key to enable the dBm function. The screen, after activation, will appear as figure below.



Indicator dBm On

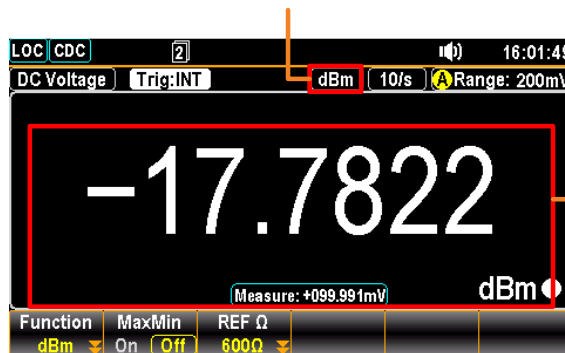

Measured dBm Value

Maximum & Minimum display Press the F2 (MaxMin) key to have the maximum and minimum measured values shown on the display.



Max. and Min measured values



Max/Min display On

Select reference resistance (REF Ω) To change the reference resistance, press the F3 (REF Ω) key to enter the setting menu. Use the Left/Right arrow keys to move cursor and Up/Down arrow keys or press Number keys to enter the desired value of reference resistance.



Push the physical Enter key or press the F6 (Enter) key to confirm the input reference resistance.



Resistance List	2	4	8	16	50	75	93
	110	124	125	135	150	250	300
	500	600	800	900	1000	1200	8000

View result in Watt When the reference resistance is less than 50 Ω, it is possible to calculate the watt value. If the reference resistance is greater than 50 Ω, please ignore this step.

To calculate the Watt power, press the F1 (Function) key followed by clicking the F3 (dBm) key again.



Watt result appears

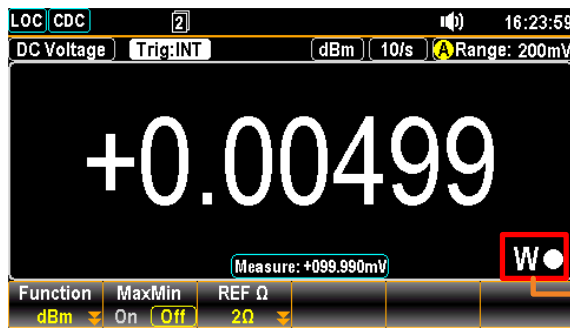

The measured B (Watt) reading

Deactivate dBm/Watt measurement

To cancel the dBm/Watt measurement, press the F1 (Function) key followed by clicking F1 (OFF) key to deactivate it or simply activate another measurement.



Measure dB

Applicable to



Equation

dB	$dBm - dBm_{ref}$
dBm	$10 \times \log_{10} (1000 \times V_{reading}^2 / R_{ref})$

Parameters

dBmref	Reference dBm value
--------	---------------------

Background

dB is, specifically, defined as [dBm-dBmref]. When the dB measurement is activated, the GDM-9052 calculates the dBm using the reading at the first moment and stores it as dBmref.

Activate dB

Press the Shift + Math key to activate Math setting menu as the following figure shown.

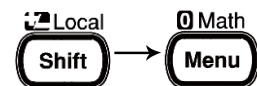

Further press the F1 (Function) key to enter the Math Function menu as the figure shown below.



Press F2 (dB) key to enable the dB function. The screen, after activation, will appear as figure below.



dB result appears

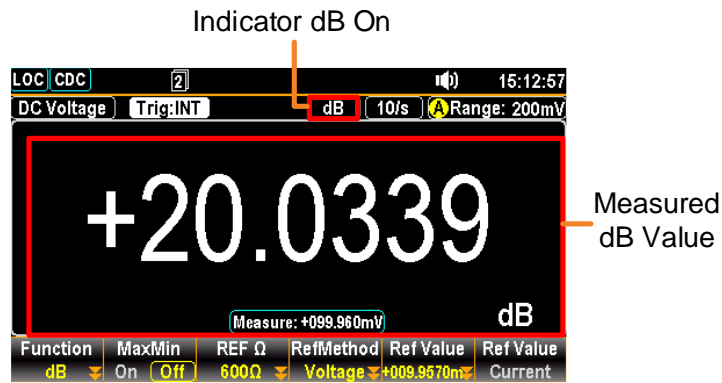

Max & Min display

Press the F2 (MaxMin) key to have the maximum and minimum measured values shown on the display.



Max. and Min measured values

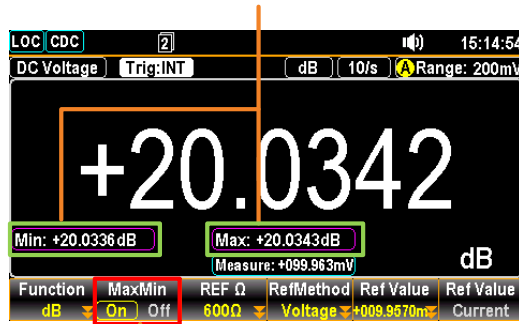

Max/Min display On

Select reference resistance (REF Ω)

To change the reference resistance, press the F3 (REF Ω) key to enter the setting menu. Use the Left/Right arrow keys to move cursor and Up/Down arrow keys or press Number keys to enter the desired value of reference resistance.



Push the physical Enter key or press the F6 (Enter) key to confirm the input reference resistance.

Enter or



Resistance List	2	4	8	16	50	75	93
	110	124	125	135	150	250	300
	500	600	800	900	1000	1200	8000

F4 (Ref Method) to select dB reference method Reference method involves the ways to calculate dB value. When dBm option is selected, user can specify a definite dBm value for dB calculation. If selecting Voltage option, system regards the defined voltage value as the Vreading parameter for dBm calculation, thus resulting in different dB value than the previous option.

Press the F4 (RefMethod) key to enter the dB Ref Method menu followed by clicking the F1 (dBm) or F2 (Voltage) key to determine which method of calculation to proceed to.

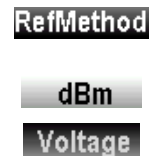



F5 (Ref Value) to define reference value (voltage or dBm)

In order to define either voltage or dBm reference value, both of which are corresponding to the previous F4 (Ref Method) option, press the F5 (Ref Value) to enter the dB Ref Value menu, and use the Left/Right arrow keys to move cursor and Up/Down arrow keys or press Number keys to enter the desired Ref value. Press the F6 (Enter) key or Physical Enter key to confirm the input value.

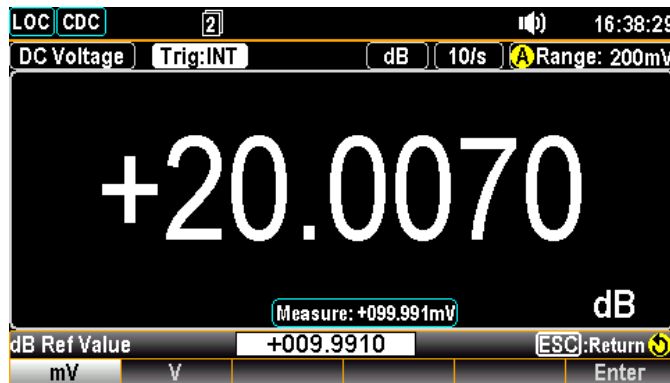

Note: when setting voltage Ref value, press the function keys to promptly define the unit.



F6 (Ref Value) key to set the dBm reference	Press the F6 (Ref Value_Current) key to instantly make the current dBm value, which is calculated by the current input voltage with the equation, as the Ref dBm (dBm reference).	
Deactivate dB measurement	To cancel the dB measurement, press the F1 (Function) key followed by clicking F1 (OFF) to deactivate it or simply activate another measurement.	

Compare Mode

Applicable to **8 ACI** **7 DCI** **9 Ω4W** **4 \leftarrow** **5 TEMP**

Background The Compare mode checks and updates if measurement data stays between the specified upper (high) and lower (low) limit.

Activate Compare mode Press the Shift + Math key to activate Math setting menu as the following figure shown.

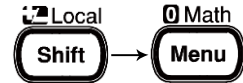

Further press the F1 (Function) key to enter the Math Function menu as the figure shown below.



Press F4 (COMP) key to enable the Compare function. The screen, after activation, will appear as figure below.

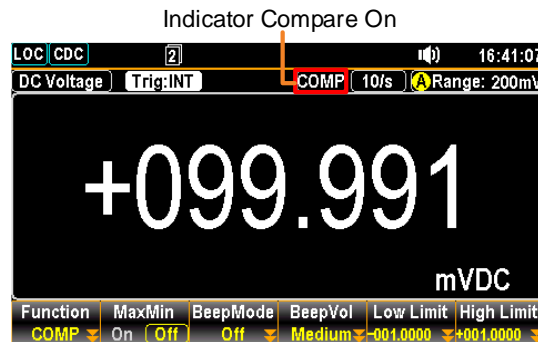

Max & Min display

Press the F2 (MaxMin) key to have the maximum and minimum measured values shown on the display.



Max. and Min measured values

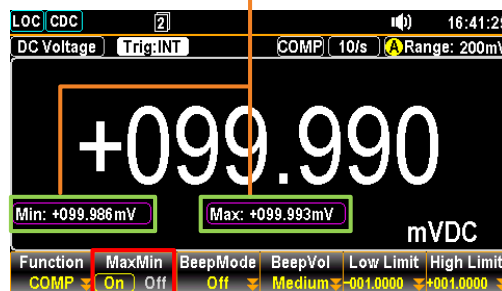

Max/Min display On

F6 (High Limit) to set high limit

Press the F6 (High Limit) key to enter the setting menu.

High Limit

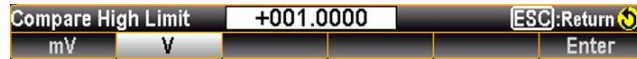

First use the functions keys to determine the unit, which varies by different measure modes. Then use function keys to decide unit value. Then use the Left/Right arrow keys to move cursor and Up/Down arrow keys or press Number keys to enter the desired value of high limit.



Push the F6 (Enter) key or the physical Enter key to make the setting into effect.

Enter or



F5 (Low Limit) to set low limit

Press the F5 (Low Limit) key to enter the setting menu.

Low Limit



First use the functions keys to determine the unit, which varies by different measure modes. Then use function keys to decide unit value. Then use the Left/Right arrow keys to move cursor and Up/Down arrow keys or press Number keys to enter the desired value of low limit.



Push the F6 (Enter) key or the physical Enter key to make the setting into effect.

Enter or



F3 (BeepMode) to define beep mode

Press the F3 (BeepMode) key to enter the beep mode setting. By enabling beep mode, user can be aware of the latest state promptly by beep voice.

BeepMode

The display shows as the figure below. Press the F2 (Pass) or F3 (Fail) key to determine the condition of beep alarm.

Press the F1 (Off) key to disable beep mode.

Pass

or

Fail

Off



F4 (BeepVol) to select beep volume

Press the F4 (BeepVol) key to enter the beep volume setting.

Select the intensity of beep volume via pressing F1 – F3 key for desired level as the figure shown below.

BeepVol

Small or **Medium** or **Large**



Compare mode result

When the measured result is within the range of high and low limit, the display shows as the figure below with purely black background indicating the state of “Pass”.

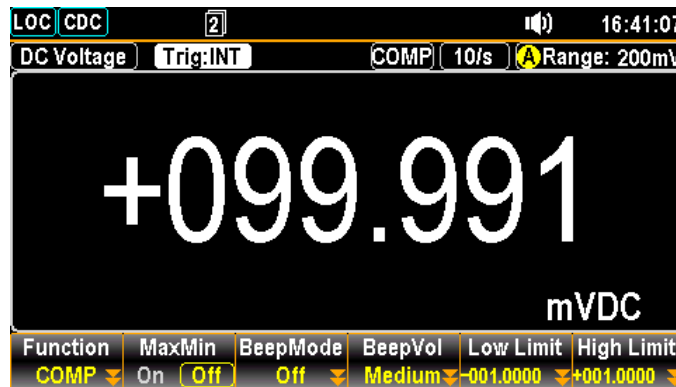

However, when measured result is either above or less than the limit range, the display appears as the figure below with boldly red background indicating the state of “Fail”.

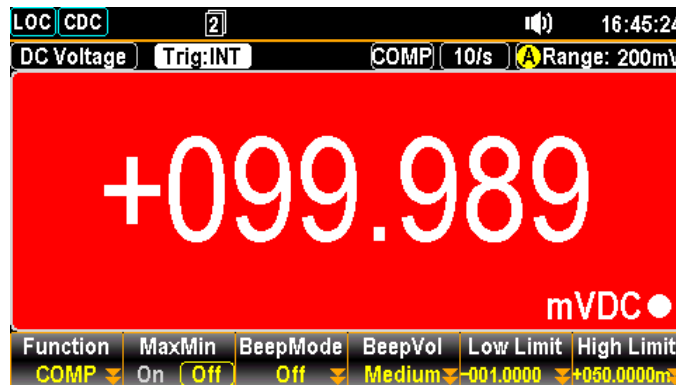

See the contents below for more details of each state in compare mode

Deactivate Compare measurement

To cancel the Compare measurement, press the F1 (Function) key followed by clicking F1 (OFF) to deactivate it or simply activate another measurement.

Function

OFF

MX+B Measurement

Applicable to **8 ACI** **7 DCI** **9 Ω4W** **4 \pm** **5 TEMP**
 ACV DCV Ω2W FREQ \rightarrow

Activate MX+B Press the Shift + Math key to activate Math setting menu as the following figure shown.

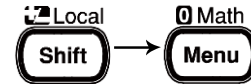

Further press the F1 (Function) key to enter the Math Function menu as the figure shown below.

Function



Press F5 (MX+B) key to enable the MX+B function. The screen, after activation, will appear as figure below.

MX+B

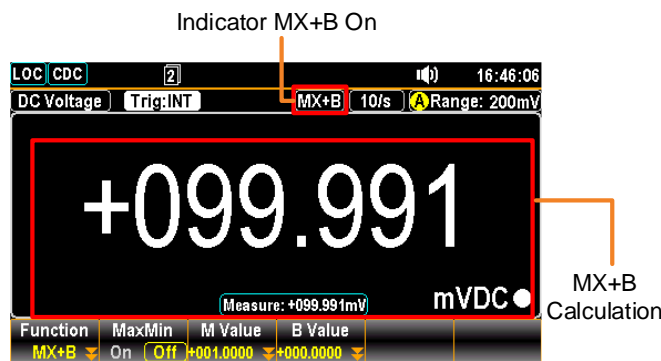

Max & Min display Press the F2 (MaxMin) key to have the maximum and minimum measured values shown on the display.

MaxMin

Max. and Min measured values

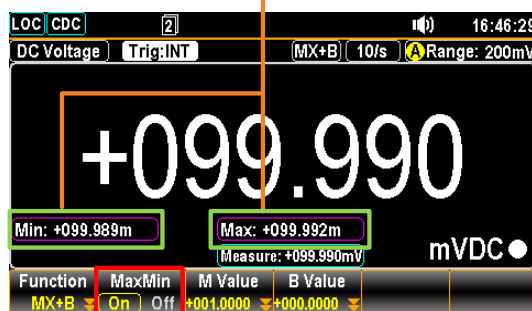

Max/Min display On

F3 (M Value) key to set the factor M Press the F3 (M Value) key to enter the MX+B M Value menu. First use function keys to decide unit value, which may vary by different measurements. Then use the Left/Right arrow keys to move cursor and Up/Down arrow keys or press Number keys to enter the desired value. See the figure below.

M Value



Press the F6 (Enter) key or the physical Enter key to confirm the input M value.

Enter or



F4 (B Value) key to set the offset B Press the F4 (B Value) key to enter the setting B Value menu. First use function keys to decide unit value, which may vary by different measurements. Then use the Left/Right arrow keys to move cursor and Up/Down arrow keys or press Number keys to enter the desired value. See the figure below.

B Value



Press the F6 (Enter) key or the physical Enter key to confirm the input B value.

Enter or



Deactivate MX+B measure To cancel the MX+B measurement, press the F1 (Function) key followed by clicking F1 (OFF) key to deactivate it or simply activate another measurement.

Function

OFF

1/X Measurement

Applicable to **8 ACI** **7 DCI** **9 Ω4W** **4 $\frac{1}{X}$** **5 TEMP**
 ACV DCV Ω2W FREQ \rightarrow

Activate 1/X Press the Shift + Math key to activate Math setting menu as the following figure shown.

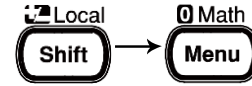

Further press the F1 (Function) key to enter the Math Function menu as the figure shown below.

Function



Press F6 (More 1/2) key to enter the next page followed by pressing the F1 (1/X) key.

More 1/2

1/X



The 1/X function will be activated as the figure below.

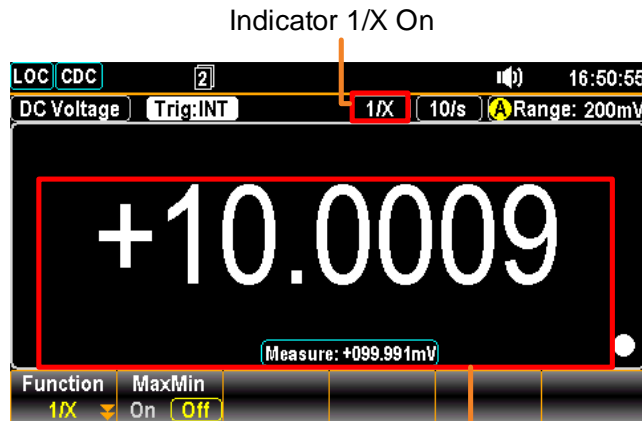

The Measured 1/X Value

Max & Min display

Press the F2 (MaxMin) key to have the maximum and minimum measured values shown on the display.

MaxMin

Max. and Min measured values

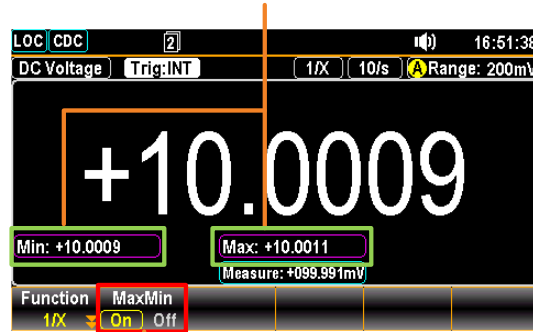

Max/Min display On

Deactivate 1/X measurement

To cancel the 1/X measurement, press the F1 (Function) key followed by clicking the F1 (OFF) key to deactivate it or simply activate another measurement.

Function
OFF

Measure Percent

Applicable to **8 ACI** **7 DCI** **9 Ω4W** **4 $\frac{1}{2}$** **5 TEMP**
 ACV DCV Ω2W FREQ →

Activate percent Press the Shift + Math key to activate Math setting menu as the following figure shown.

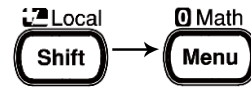

Further press the F1 (Function) key to enter the Math Function menu as the figure shown below.



Press F6 (More 1/2) key to enter the next page followed by pressing the F2 (PERC) key.



The Percent function will be activated as the figure below.

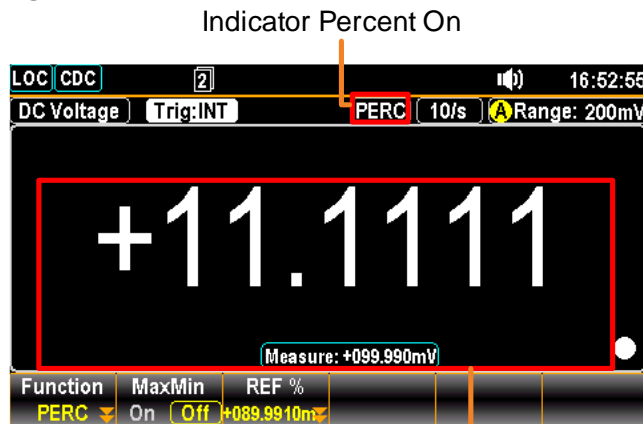

The Measured Percent Value

Max & Min display Press the F2 (MaxMin) key to have the maximum and minimum measured values shown on the display.



Max. and Min measured values

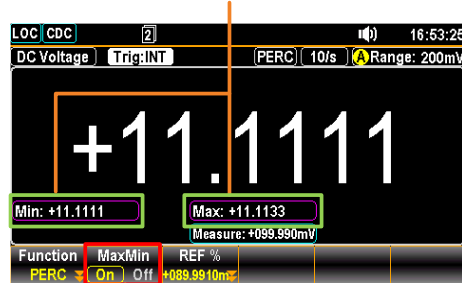

Max/Min display On

F3 (REF %) Press the F3 (REF %) key to enter the Percent REF % menu. First use the functions keys to determine the unit, which may vary by different measure modes. Then use the Left/Right arrow keys to move cursor and Up/Down arrow keys or press Number keys to enter the desired value. See the figure below.

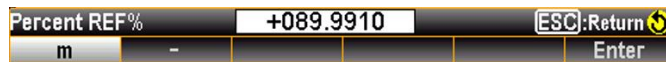

Push the physical Enter key or press the F6 (Enter) key to confirm the input value.



Deactivate percent measurement To cancel the percent measurement, press the F1 (Function) key followed by clicking F1 (OFF) to deactivate it or simply activate another measurement.



DIGITAL I/O

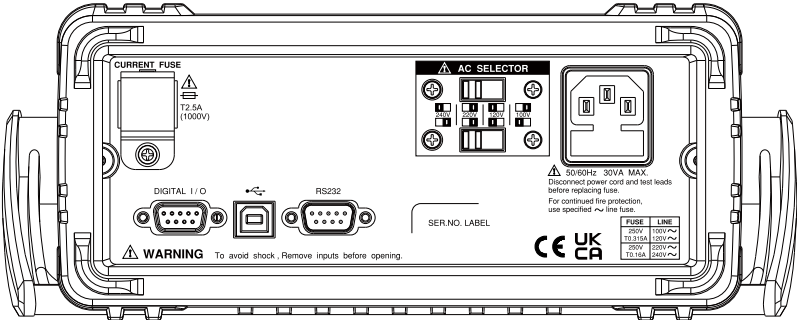

Digital I/O Overview	95
Normal Mode	96
User Mode	97

Digital I/O Overview

Background The Digital I/O port is a dual function port. By default (Normal Mode) the port is used with the compare function to output Hi Fail, Lo Fail, Pass, and EOM (end of measurement) signals. In addition, there is also a TRIG IN input pin.

As a secondary function (User Mode), the Digital I/O port can have the output state of pins 1,6,7,8 controlled via remote control.

Related Commands DIGitalio:MODE?
 DIGitalio:MODE {NORM | USER}
 DIGitalio:SETup (For User Mode)

Pin Assignment

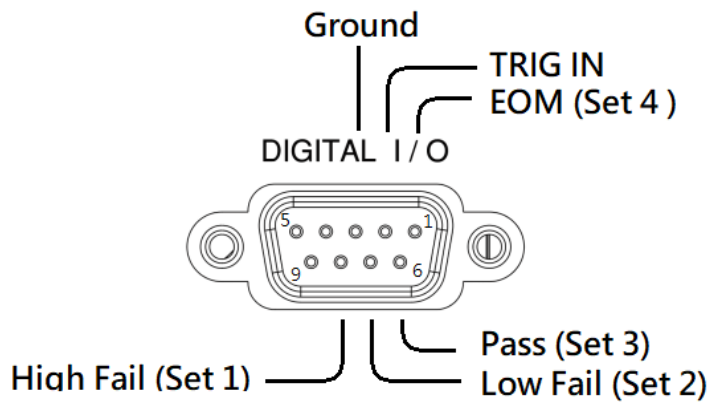

Pin No.	Normal Mode	User Mode
1	EOM	Set 4
2	TRIG IN	TRIG IN
3	Ground	Ground
4	NC	NC
5	NC	NC
6	Pass	Set 3
7	Low Fail	Set 2
8	High Fail	Set 1
9	NC	NC

Wiring Diagram
Pins 1,6,7,8

Pins 1, 6, 7, 8 are open-collector outputs, with a max input of 30 mA and Driver Voltage ranging from 3.6 VDC to 30 VDC. All outputs are active low.

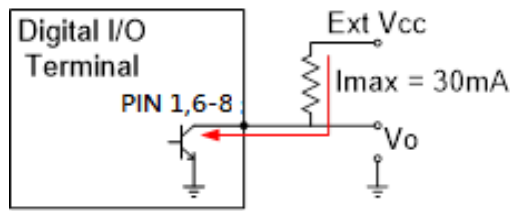

Wiring Diagram
Trig In (Pin 2)

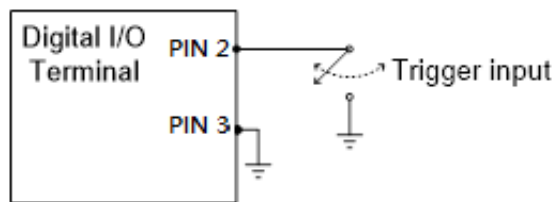

Normal Mode

Overview

The Normal Mode outputs the pass/fail results of the Compare function. Each signal is an active low signal. In addition, an active low pulse of approximately 5 μ s is output to indicate the end of compare measurement (EOM).

When the input signal exceeds the high threshold or the low threshold, the High Fail or Low Fail pin is pulled low. When the signal stays within the threshold levels, the Pass pin is pulled low.

Timing Diagram

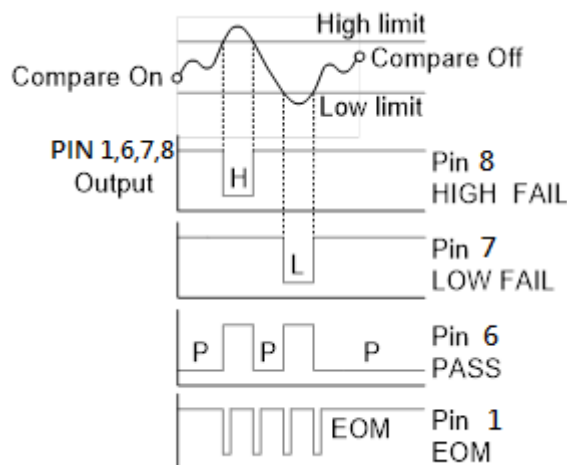

User Mode

Overview User mode can only be used when using a remote control interface. Likewise this mode can only be enabled or disabled via remote control. Please see the digital I/O commands on page 131 for full usage details.

Related Commands DIGitalio:MODE {USER|NORM|?}
DIGitalio{X}:SETup {ON|OFF}

- Procedure**
1. Connect to the GDM-9052 remotely, see page 111 for remote control options.
 2. Enable the user mode using the DIGitalio:MODE command. See page 147.
 3. Set the state of pins 1 ~ 4 using the DIGitalio{X}:SETup command. See page 147.
-

Example	DIG:MODE?	Queries the mode.
	>NORM	Returns Norm mode.
	DIG:MODE USER	Sets to USER mode.
	DIG1:SETup ON	Turns pin1 output on.
	DIG2:SETup ON	Turns pin2 output on.
	DIG3:SETup ON	Turns pin3 output on.
	DIG4:SETup ON	Turns pin4 output on.
	DIG4:SETup?	Queries pin4 output state.
	>1	Returns pin4 output state.
	DIG:MODE NORM	Sets back to NORM mode.

SYSTEM & FIRMWARE

View System Info 99

View System Info

Background View system information including Vendor, Model Name, Serial Number, Master Firmware and Slave Firmware.

- Step**
1. Press the Menu key, the System configuration menu appears. And press the NEXT key repeatedly to move to the Cali&Info – SystemInfo field.

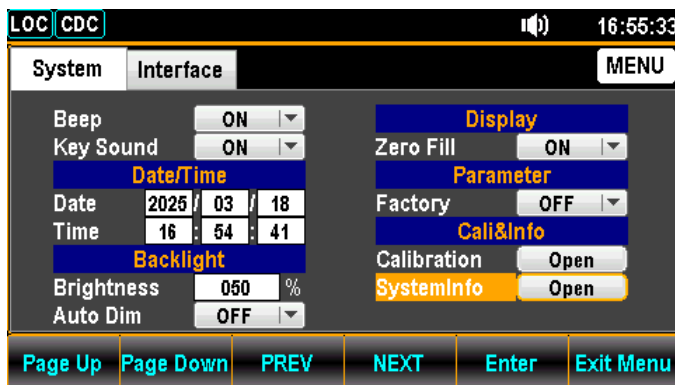
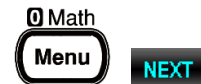

2. Press the F5 (Enter) key or physical Enter key to enter the System Information where all the contents are clearly exposed.

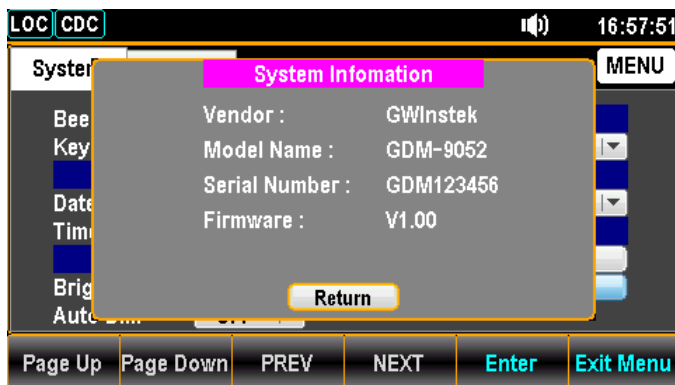

MENU SETTING

Configure System	101
Beep Setting	101
Key Sound Setting	102
Date Setting	103
Time Setting	104
Brightness Setting	105
Auto Dim Setting.....	106
Zero Fill Setting.....	107
Factory Setting.....	108
Calibration Setting	109
View System Info	109

Configure System

Beep Setting

Background Enable or Disable Beep Sound.

- Step 1. Press the Menu key, the System configuration menu appears.

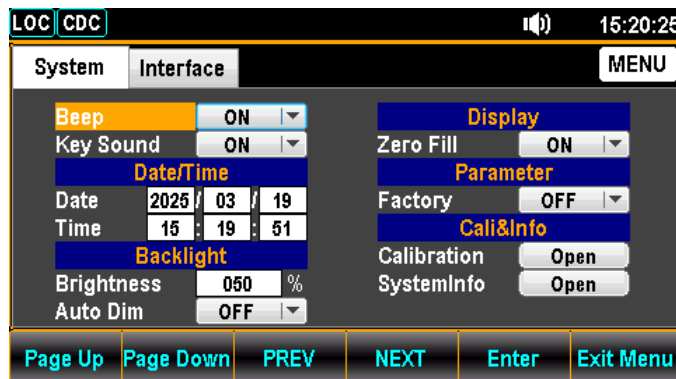

2. Press the F5 (Enter) key or physical Enter key followed by pressing up and down arrow keys to land on the ON option.

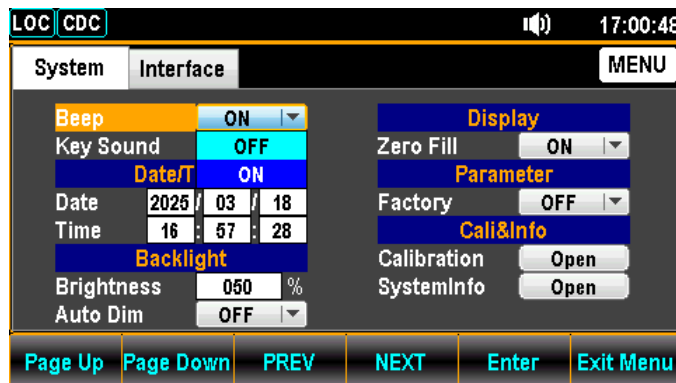

3. Press the F5 (Enter) key or physical Enter key to select the ON option for beep setting.



Key Sound Setting

Background Enable or Disable Key Sound.

- Step 1. Press the Menu key, the System configuration menu appears. And press the NEXT key repeatedly to move to the Key Sound field.

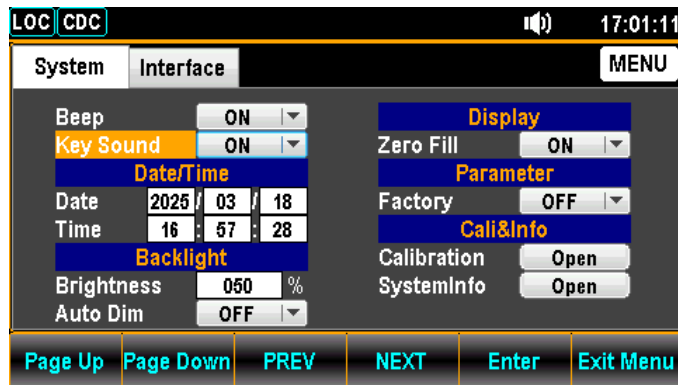
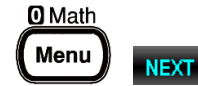

2. Press the F5 (Enter) key or physical Enter key followed by pressing up and down arrow keys to land on the ON option.

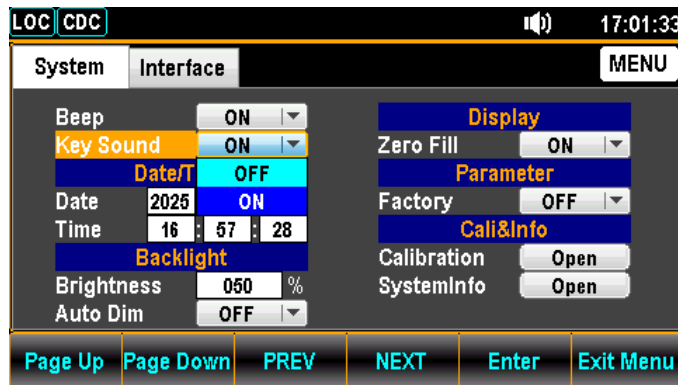
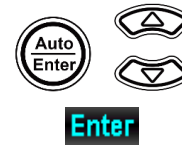

3. Press the F5 (Enter) key or physical Enter key to select the ON option for key sound.



Date Setting

Background Manually adjust date for system.

- Step
1. Press the Menu key, the System configuration menu appears. And press the NEXT key repeatedly to move to the Date/Time – Date field.

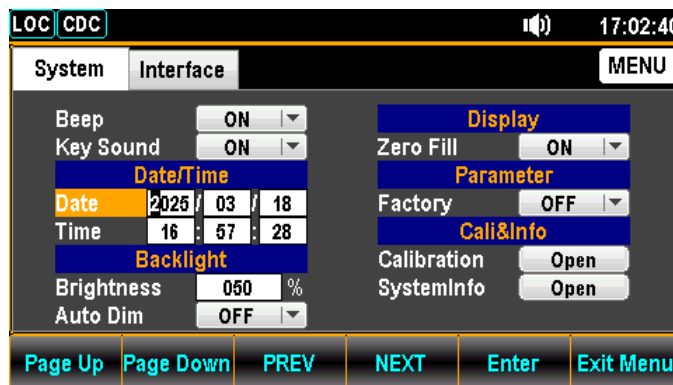

2. Use the Left/Right arrow keys to move the cursor followed by pressing Up/Down arrow keys or press Number keys to define year of Date.

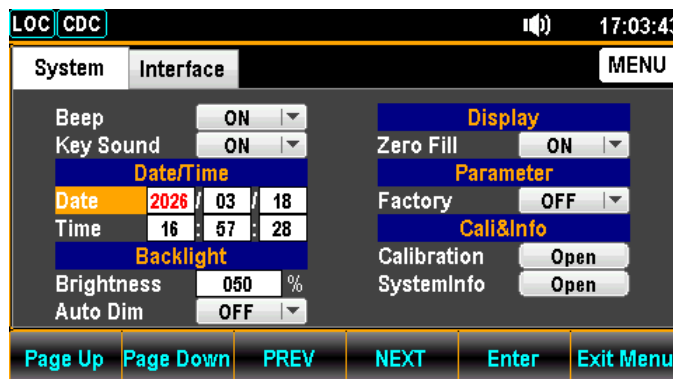

3. Press the F5 (Enter) key or physical Enter key to confirm the input digit for year of Date.

Enter



4. Repeat steps 2 to 3 for month and day.

Time Setting

Background Manually adjust time for system.

- Step 1. Press the Menu key, the System configuration menu appears. And press the NEXT key repeatedly to move to the Date/Time – Time field.

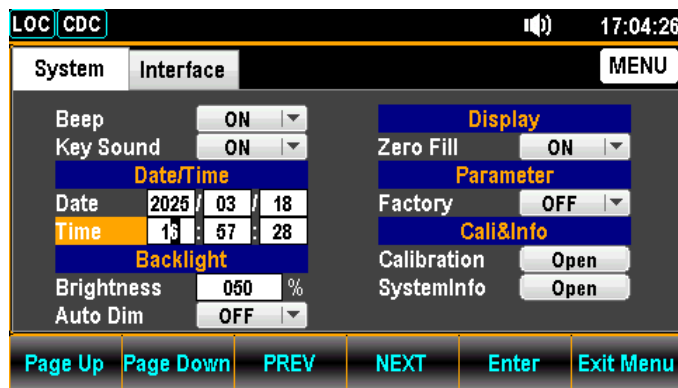

2. Use the Left/Right arrow keys to move the cursor followed by pressing Up/Down arrow keys or press Number keys to define hour of Time.

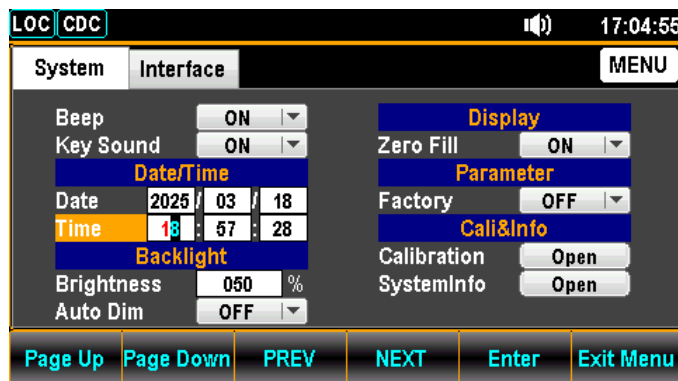

3. Press the F5 (Enter) key or physical Enter key to confirm the input digit for hour of Time.



4. Repeat steps 2 to 3 for minute and second.

Brightness Setting

Background Backlight brightness adjustment

Step

1. Press the Menu key, the System configuration menu appears. And press the NEXT key repeatedly to move to the Backlight – Brightness field.

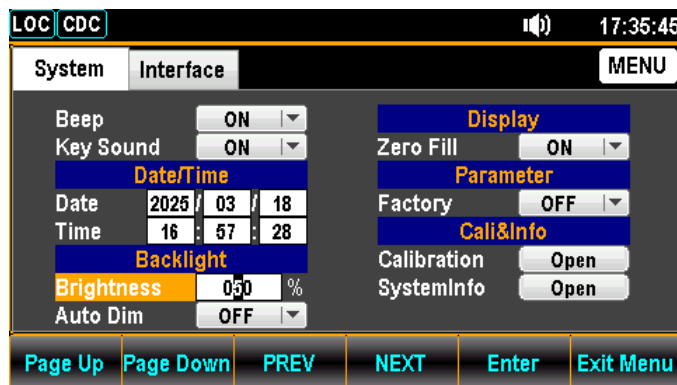

2. Use the Left/Right arrow keys to move the cursor followed by pressing Up/Down arrow keys or press Number keys to define digit.

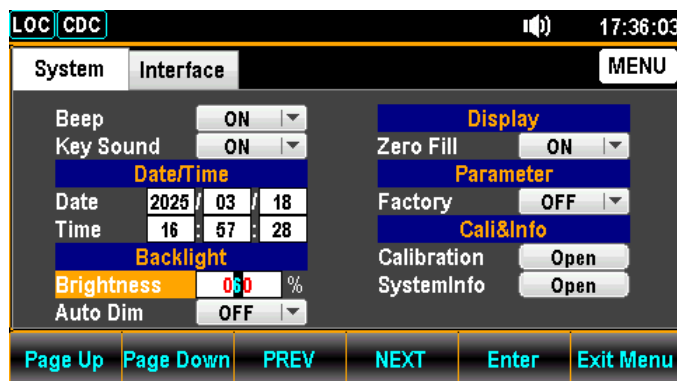

3. Press the F5 (Enter) key or physical Enter key to confirm the input digit for backlight brightness.



Auto Dim Setting

Background Set a duration before activation of automatic dim out for screen display.

- Step**
1. Press the Menu key, the System configuration menu appears. And press the NEXT key repeatedly to move to the Backlight – Auto Dim field.

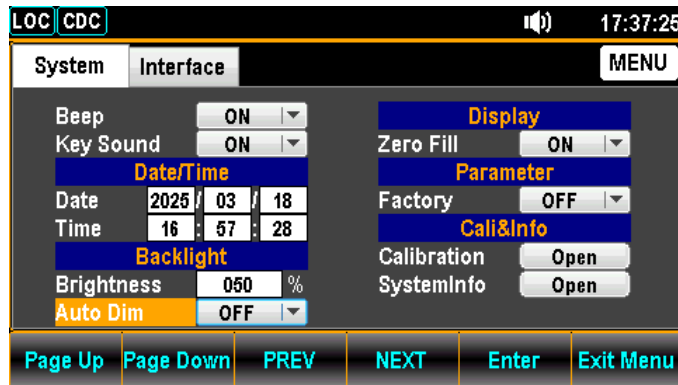
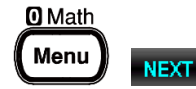

2. Press the F5 (Enter) key or physical Enter key followed by pressing up and down arrow keys to land on a desired option.

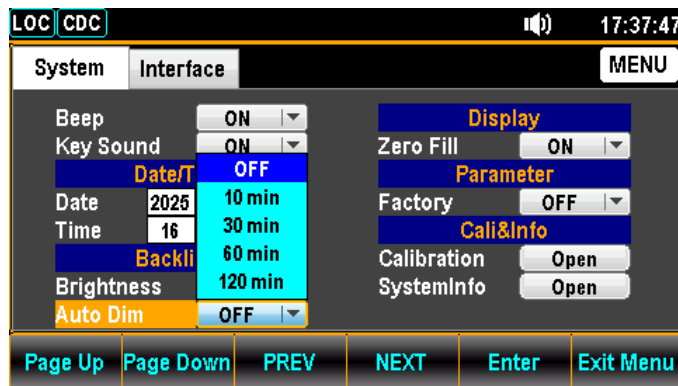

3. Press the F5 (Enter) key or physical Enter key to confirm the setting for backlight auto dim.



Zero Fill Setting

Background Automatically omit the redundant zero “0” values displayed, which makes measured reading more concise.

- Step**
1. Press the Menu key, the System configuration menu appears. And press the NEXT key repeatedly to move to the Display – Zero Fill field.

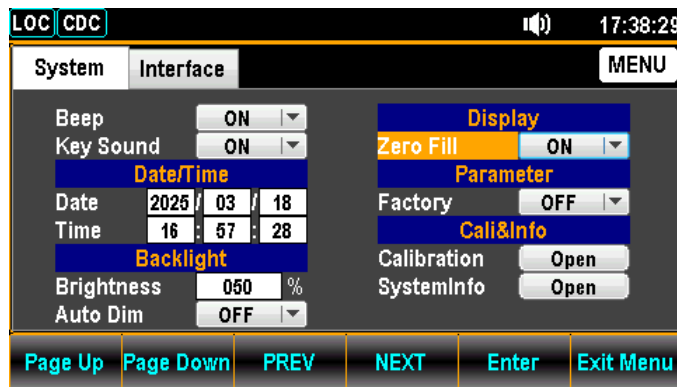
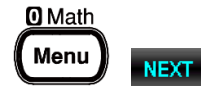

2. Press the F5 (Enter) key or physical Enter key followed by pressing up and down arrow keys to land on the ON option.

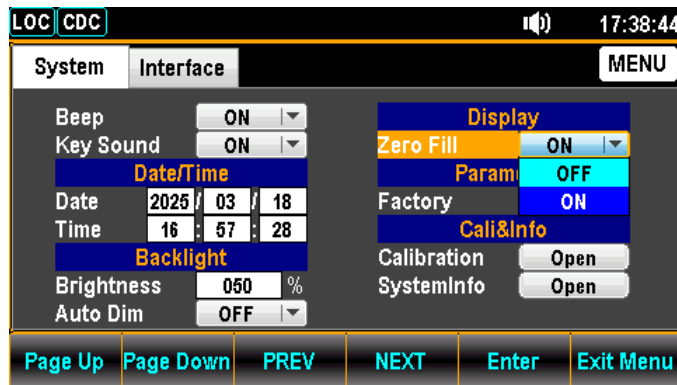

3. Press the F5 (Enter) key or physical Enter key to select the ON option for zero fill.



Factory Setting

Background The Factory function restores the unit back to the factory default settings.

- Step**
1. Press the Menu key, the System configuration menu appears. And press the NEXT key repeatedly to move to the Parameter - Factory field.

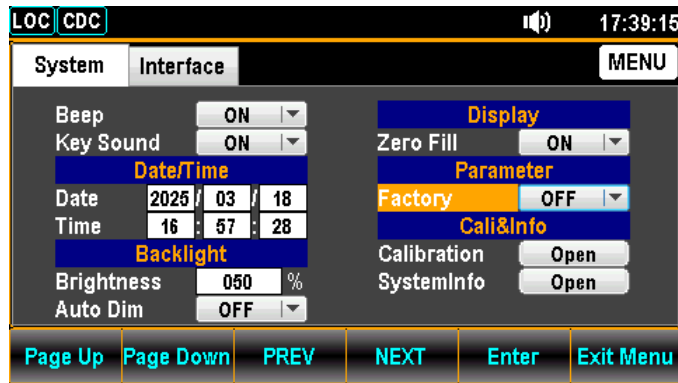

2. Press the F5 (Enter) key or physical Enter key followed by pressing up and down arrow keys to land on the ON option.

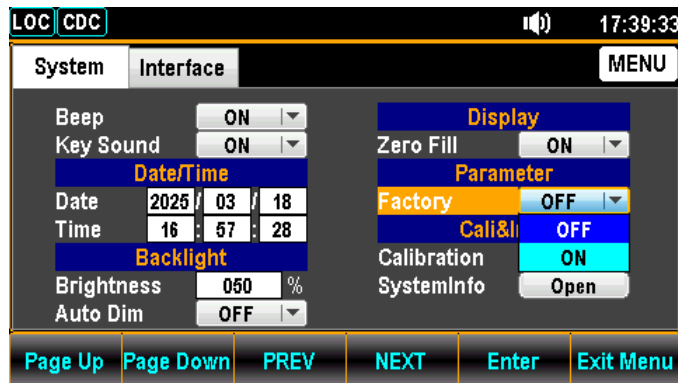

3. Press the F5 (Enter) key or physical Enter key to restore back to the default settings.



Calibration Setting

Background With granted password, the calibration procedure can be only executed by the certified technician in accordance with the standard instruments. Refer to the manufacturer or qualified personnel of authorized dealer for details.

View System Info

Background View system information including Vendor, Model Name, Serial Number, Master Firmware and Slave Firmware.

- Step**
1. Press the Menu key, the System configuration menu appears. And press the NEXT key repeatedly to move to the Security&Info – SystemInfo field.

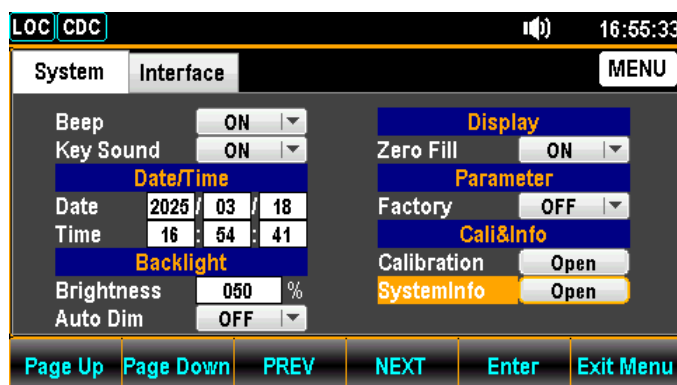
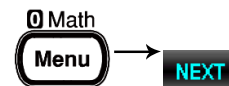

2. Press the F5 (Enter) key or physical Enter key to enter the System Information where all the critical contents are exposed for check.



REMOTE CONTROL

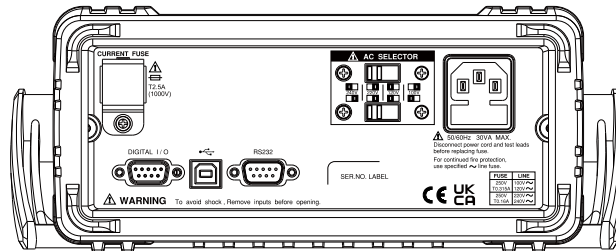

Configure Interface	111
Return to Local Control Mode	111
Configure SCPI ID Setting.....	111
Configure USB Interface	112
Set the USB Protocol	115
Configure RS232 Interface	116
Set the EOL Character	121
Set the Separation Character	121
Command Syntax.....	122
Command Set	125
Configure Commands (1 st).....	125
Configure Commands (2 nd)	125
Measure Commands	126
Sense Commands.....	126
Calculate Commands.....	127
Trigger Commands	128
Display Commands.....	128
DIGital IO Commands	129
System Commands.....	129
Status Commands	130
Interface Commands	130
Common Commands	130
CONFigure Commands(1 st).....	131
Status system	154

Configure Interface

Return to Local Control Mode

Background When the unit is in remote control mode, the RMT icon  above the main display can be seen. When this icon is not displayed, it indicates that the unit is in local control mode.

In order to switch back to the Local control mode (front panel operation), press the Shift key.



Configure SCPI ID Setting

Background The SCPI ID can be manually configured by user. When Identity of SCPI ID is set to 834X, it indicates the pattern of commands is compatible with the previous GDM-834X models also manufactured by GW INSTEK.

Step 1. Press the Menu key, and then the Page Down key repeatedly until the Interface configuration menu appears.

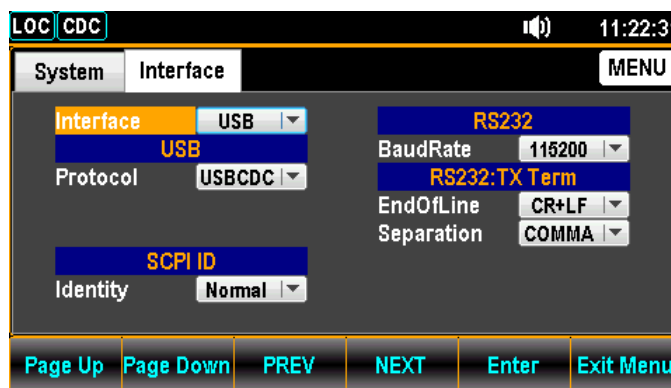
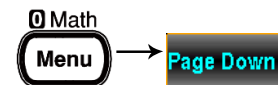

2. Press the F4 (NEXT) key repeatedly to move to the SCPI ID field.



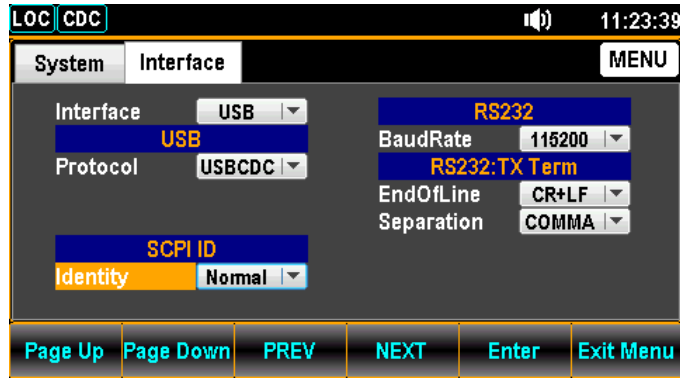

3. Press the F5 (Enter) key or physical Enter key followed by pressing up and down arrow keys to land on the desired SCPI ID Identity option.

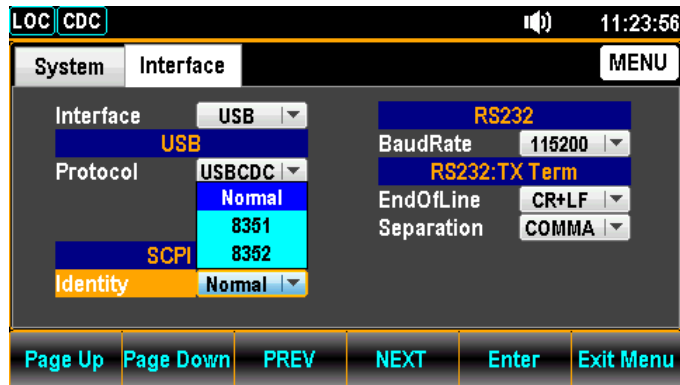

4. Press the F5 (Enter) key or physical Enter key to confirm the desired SCPI ID Identity option



Configure USB Interface

USB Configuration Unit side connector Real panel, Type B, device

USB Speed 2.0 (Full speed)

- Step
1. Press the Menu key, and then the Page Down key repeatedly until the Interface configuration menu appears.



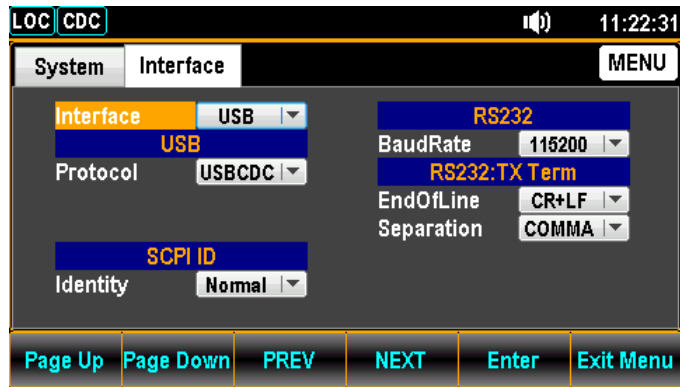

2. Press the F5 (Enter) key or physical Enter key followed by pressing up and down arrow keys to land on the USB option.

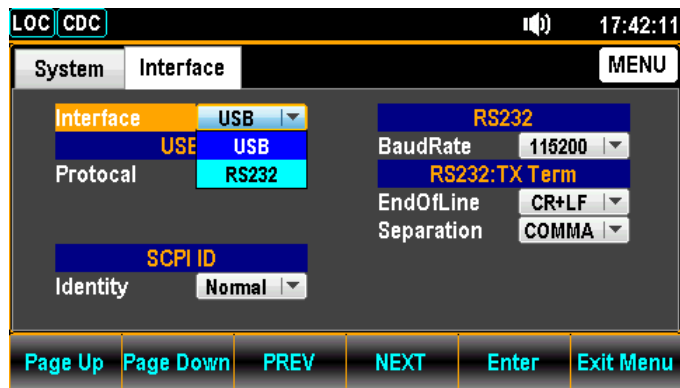

3. Press the F5 (Enter) key or physical Enter key to select the USB option.



4. Press the F4 (NEXT) key repeatedly to move to the USB - Protocol field.

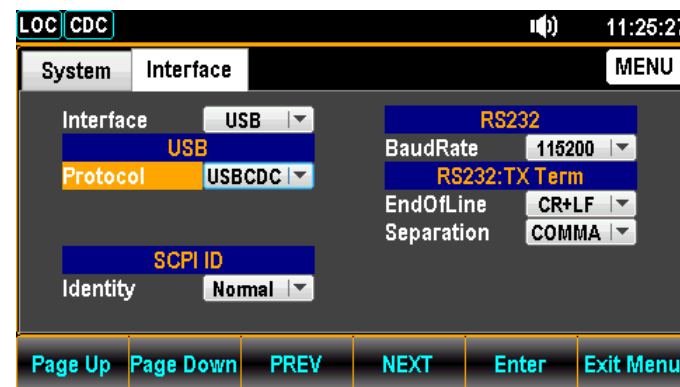

5. Press the F5 (Enter) key or physical Enter key followed by pressing up and down arrow keys to land on the desired USB Protocol option.

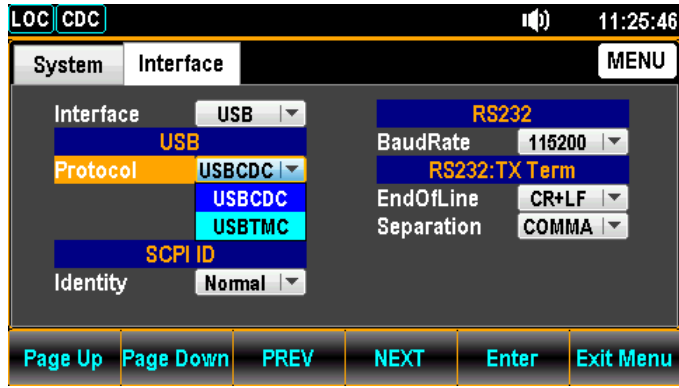

6. Press the F5 (Enter) key or physical Enter key to confirm the USB Protocol option.



7. Connect the USB cable to the rear panel terminal (upper port).



Set the USB Protocol

Description The USB device port on the rear panel is used for remote control. The USB port can be configured as either a TMC or CDC interface.

Before the GDM-9052 can be used for remote control utilizing the CDC or TMC USB class, install the appropriate CDC or TMC USB driver included on the User Manual CD.

USBCDC:

The USB port on the GDM-9052 will appear as a virtual COM port to a connected PC.

USBTMC:

The GDM-9052 can be controlled using National Instruments NI-Visa software*. NI-Visa supports USB TMC.



*To use the TMC interface National Instruments Measurement and Automation Explorer can be used. This program is available on the NI website, www.ni.com, via a search for the VISA Run-time Engine page, or “downloads” at the following URL, <http://www.ni.com/visa/>

Configure RS232 Interface

RS232 Configuration	Connector	D-sub 9 pin, male
	Baud rate	115200/57600/38400/19200/9600
	Data bits	8
	Parity	none
	Stop bits	1

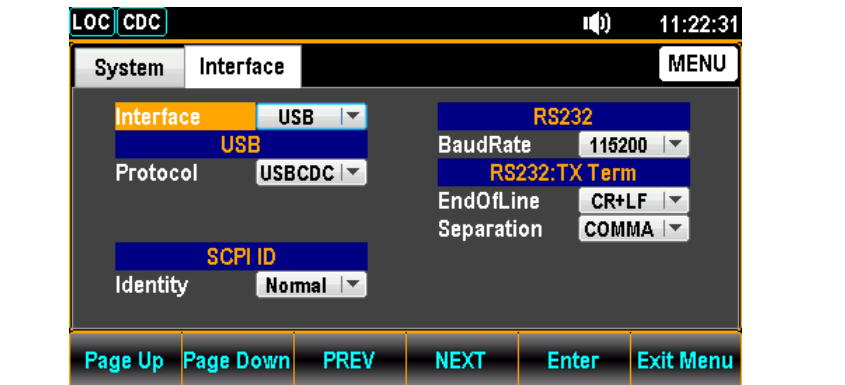
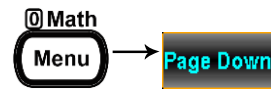

Step

1. Press the Menu key, and then the Page Down key repeatedly until the Interface configuration menu appears.



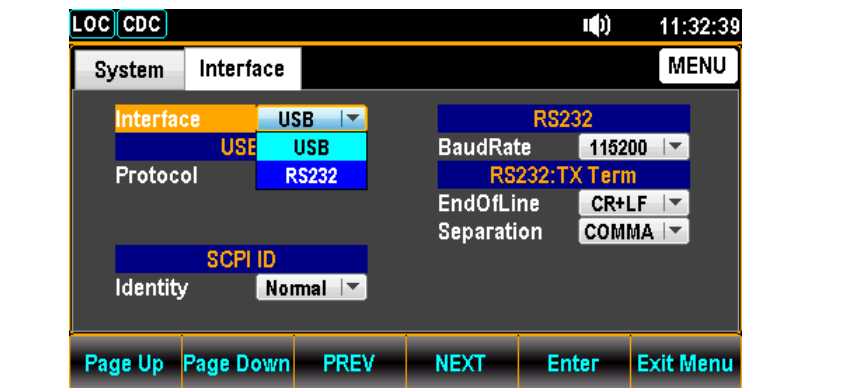



2. Press the F5 (Enter) key or physical Enter key followed by pressing up and down arrow keys to land on the RS232 option.



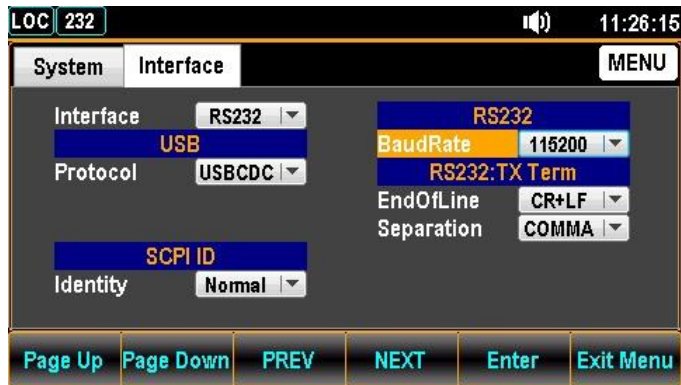

3. Press the F5 (Enter) key or physical Enter key to select the RS232 option.  

4. Press the F4 (NEXT) key repeatedly to move to the RS232 - Baud Rate field. 

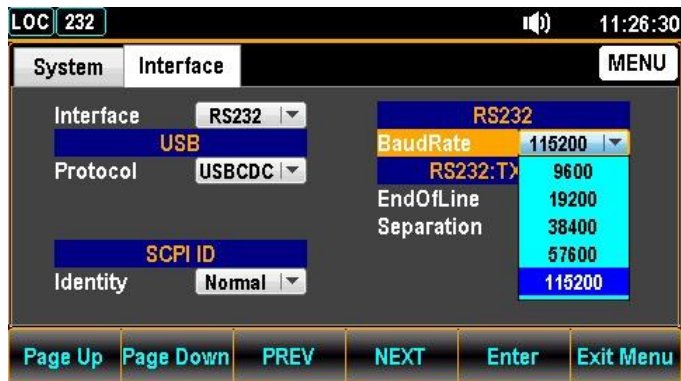

5. Press the F5 (Enter) key or physical Enter key followed by pressing up and down arrow keys to land on the desired RS232 Baud Rate option.    



6. Press the F5 (Enter) key or physical Enter key again to confirm the desired RS232 Baud Rate option.  

7. Press the F4 (NEXT) key repeatedly to move to the RS232: TX Term - EndOfLine field. 

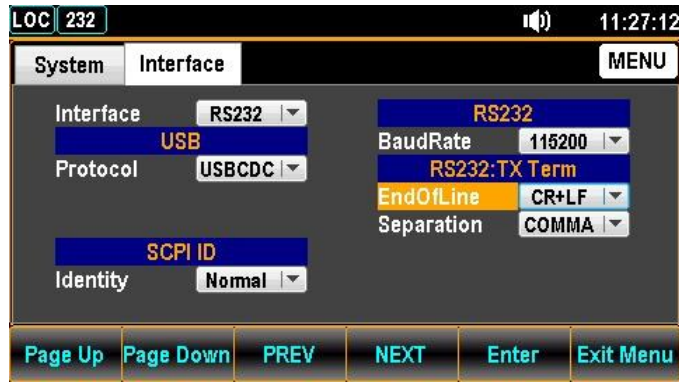

8. Press the F5 (Enter) key or physical Enter key followed by pressing up and down arrow keys to land on the desired RS232: TX Term - EndOfLine option.



Enter

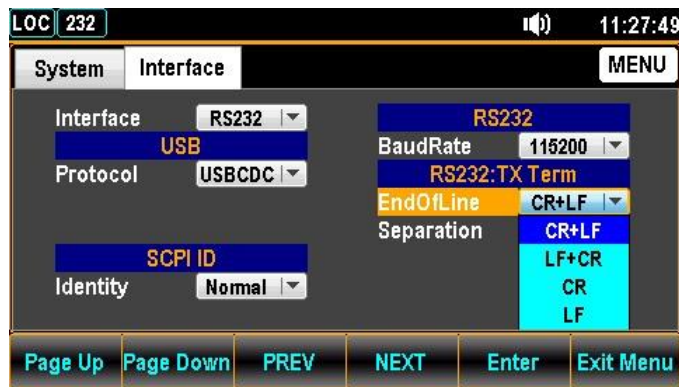

9. Press the F5 (Enter) key or physical Enter key again to confirm the desired RS232: TX Term EndOfLine option.



Enter



NOTE USBTMC is fixed with only LF option.

10. Press the F4 (NEXT) key repeatedly to move to the RS232: TX Term - Separation field.

NEXT

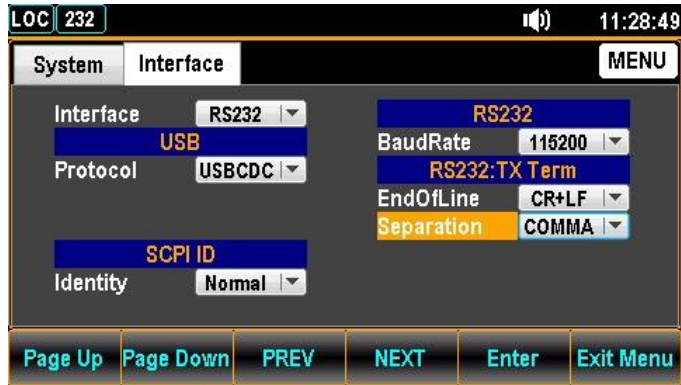

11. Press the F5 (Enter) key or physical Enter key followed by pressing up and down arrow keys to land on the desired RS232: TX Term - Separation option.

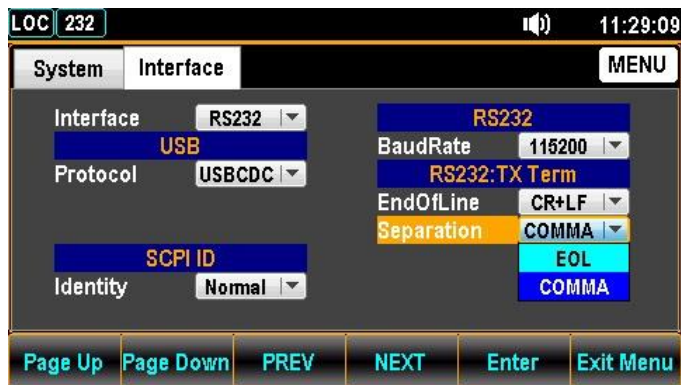

12. Press the F5 (Enter) key or physical Enter key again to confirm the desired RS232: TX Term - Separation option.



13. Connect the RS232 cable to the rear panel terminal.

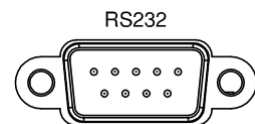

RS232 Pin Assignment	Pin	Input/Output	Description
	1	-----	No Connection
	2	Input	Receive Data (RxD)
	3	Output	Transmit Data (TxD)
	4	-----	No Connection
	5	-----	Signal Ground (SG)
	6	-----	No Connection
	7	-----	No Connection
	8	-----	No Connection
	9	-----	No Connection

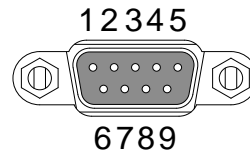

RS-232 Connection

GDM-9052 provides the complete RS-232 signals control. Select the corresponding null-modem cable, which has the DB-9 female connectors on both ends, when the port of DB-9 male connector on PC is utilized. The connecting diagram is shown as the following figure where the pin 2 (TxD) crossly links with the pin 3 (RxD) and the pin 5 (GND) is the necessary connection.

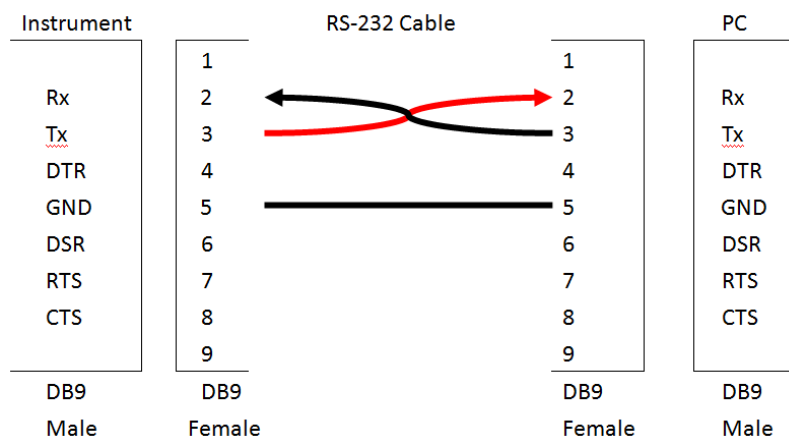

Set the EOL Character

Description The TX TERM configuration menu can set the EOL (end-of-line) character for return messages.

The EOL characters that can be received from the PC include CR+LF, LF+CR, CR or LF. The most common EOL character is CR+LF.



The USBTMC's EOL character is fixed with LF.

EOL CR+LF, LF+CR, CR, LF (default = CR+LF)

Set the Separation Character

Description The TX TERM configuration menu can set the separation character for multiple return measurement values.



The USBTMC's separation character is fixed with comma.

Command Syntax

Compatible Standard	IEEE488.2	Partial compatibility
	SCPI, 1994	Partial compatibility

Command Structure SCPI (Standard Commands for Programmable Instruments) commands follow a tree-like structure, organized into nodes. Each level of the command tree is a node. Each keyword in a SCPI command represents each node in the command tree. Each keyword (node) of a SCPI command is separated by a colon (:).

For example, the diagram below shows an SCPI sub-structure and a command example.

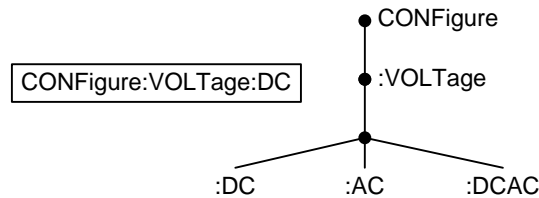

Command Types There are a number of different instrument commands and queries. A command sends instructions or data to the unit and a query receives data or status information from the unit.

Command types

Simple A single command with/without a parameter

Example CONFigure:VOLTagE:DC

Query A query is a simple or compound command followed by a question mark (?). A parameter (data) is returned.

Example CONFigure:RANGe?

Command Forms Commands and queries have two different forms, long and short. The command syntax is written with the short form of the command in capitals and the remainder (long form) in lower case.

The commands can be written either in capitals or lower-case, just so long as the short or long forms are complete. An incomplete command will not be recognized.

Below are examples of correctly written commands.

Long form CONFigure:DIODe
 CONFIGURE:DIODE
 Configure:diode

Short form CONF:DIOD
 conf:diod

Square Brackets

Commands that contain square brackets indicate that the contents are optional. The function of the command is the same with or without the square bracketed items, as shown below. For example, for the query:

[SENSe:]UNIT?

Both **SENSe:UNIT?** and **UNIT?** are valid forms.

Command Format

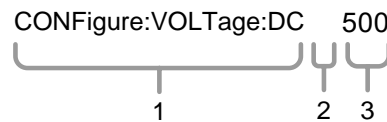

- 1. Command header
- 2. Space
- 3. Parameter 1

Common Input Parameters

Type	Description	Example
<Boolean>	boolean logic	0, 1
<NR1>	integers	0, 1, 2, 3
<NR2>	decimal numbers	0.1, 3.14, 8.5
<NR3>	floating point with exponent	4.5e-1, 8.25e+1
<NRf>	any of NR1, 2, 3	1, 1.5, 4.5e-1
[MIN] (Optional parameter)	For commands, this will set the setting to the lowest value. This parameter can be used in place of any numerical parameter where indicated. For queries, it will return the lowest possible value allowed for the particular setting.	

[MAX] (Optional parameter)	For commands, this will set the setting to the default value. This parameter can be used in place of any numerical parameter where indicated.	For queries, it will return the highest possible value allowed for the particular setting.			
DEF	For commands, this will set the setting to the default value. This parameter can be used in place of any numerical parameter where indicated.	For queries, it will return the default value allowed for the particular setting.			
Automatic parameter range selection	The GDM-9052 automatically sets the command parameter to the next available value.				
Example	<p>conf:volt:dc 5</p> <p>This will set the measurement item to DC Voltage and the range to 5 V. There is no 1 V range so the DMM selects the next available range, 5 V.</p>				
Message Terminator (EOL)	Remote Command	<p>Marks the end of a command line. The following messages are in accordance with IEEE488.2 standard.</p> <table border="0"> <tr> <td data-bbox="687 1395 927 1426">LF, CR, CR+LF</td> <td data-bbox="1023 1395 1310 1507" rowspan="2">The most common EOL character is CR+LF</td> </tr> <tr> <td data-bbox="687 1449 807 1480">LF+CR</td> </tr> </table>	LF, CR, CR+LF	The most common EOL character is CR+LF	LF+CR
LF, CR, CR+LF	The most common EOL character is CR+LF				
LF+CR					
Message Separator	EOL or ; (semicolon)	Command Separator			

Command Set

Configure Commands (1st)

CONFigure:VOLTage:DC	131
CONFigure:VOLTage:AC.....	131
CONFigure:CURRent:DC.....	131
CONFigure:CURRent:AC.....	131
CONFigure:RESistance	131
CONFigure:FRESistance.....	131
CONFigure:FREQuency	131
CONFigure:PERiod	132
CONFigure:CONTinuity	132
CONFigure:DIODE	132
CONFigure:TEMPerature:TCouple.....	132
CONFigure:CAPacitance.....	132
CONFigure:FUNction?	132
CONFigure:RANGE?	132
CONFigure:AUTO	132
CONFigure:AUTO?.....	133

Configure Commands (2nd)

CONFigure2:VOLTage:DC	133
CONFigure2:VOLTage:AC.....	133
CONFigure2:CURRent:DC.....	133
CONFigure2:CURRent:AC.....	133
CONFigure2:RESistance	133
CONFigure2:FRESistance.....	133
CONFigure2:FREQuency	133
CONFigure2:PERiod	134
CONFigure2:OFF	134
CONFigure2:FUNction?	134
CONFigure2:RANGE?	134
CONFigure2:AUTO	134
CONFigure2:AUTO?	134

Measure Commands

MEASure:VOLTage:DC?	135
MEASure:VOLTage:AC?	135
MEASure:CURRent:DC?	135
MEASure:CURRent:AC?	135
MEASure:RESistance?	135
MEASure:FRESistance?	135
MEASure:FREQuency?	136
MEASure:PERiod?	136
MEASure:CONTinuity?	136
MEASure:DIODE?	136
MEASure:TEMPerature:TCouple?	136
MEASure:CAPacitance?	136
MEASure2:VOLTage:DC?	136
MEASure2:VOLTage:AC?	137
MEASure2:CURRent:DC?	137
MEASure2:CURRent:AC?	137
MEASure2:RESistance?	137
MEASure2:FRESistance?	137
MEASure2:FREQuency?	137
MEASure2:PERiod?	137

Sense Commands

[SENSe:]TEMPerature:TCouple:TYPE	138
[SENSe:]TEMPerature:TCouple:TYPE?	138
[SENSe:]TEMPerature:RJUNction:SIMulated	138
[SENSe:]TEMPerature:RJUNction:SIMulated?	138
[SENSe:]DETEctor:RATE	138
[SENSe:]DETEctor:RATE?	138
[SENSe:]FREQuency:INPutjack	138
[SENSe:]FREQuency:INPutjack?	138
[SENSe:]PERiod:INPutjack	138
[SENSe:]PERiod:INPutjack?	139
[SENSe:]CONTInuity:THReshold	139
[SENSe:]CONTInuity:THReshold?	139

[SENSe:]UNIT	139
[SENSe:]UNIT?	139
[SENSe:]FUNctIon[X]	139
[SENSe:]FUNctIon[X]?	139
[SENSe:]DATA?	139
[SENSe:]CAPacItance:CABLe:CALibratIon	140
[SENSe:] VOLTagE:DC:IMPedance:AUTO	140
[SENSe:]VOLTagE:DC:IMPedance:AUTO?	140
[SENSe:] VOLTagE:DC:IMPedance:EXTend	140
[SENSe:]VOLTagE:DC:IMPedance:EXTend?	140
[SENSe:]FILTer:COUnT	140
[SENSe:]FILTer:COUnT?	140
[SENSe:]FILTer:STATe	140
[SENSe:]FILTer:STATe?	140
[SENSe:]FILTer:TCONtrol.....	141
[SENSe:]FILTer:TCONtrol?	141
[SENSe:]FILTer:WINDow.....	141
[SENSe:]FILTer:WINDow?	141

Calculate Commands

CALCulate:FUNctIon	142
CALCulate:FUNctIon?	142
CALCulate:STATe.....	142
CALCulate:STATe?	142
CALCulate:MINImum?	142
CALCulate:MAXImum?.....	142
CALCulate:HOLD:REFerence	142
CALCulate:HOLD:REFerence?.....	142
CALCulate:REL:REFerence	142
CALCulate:REL:REFerence?	142
CALCulate:LIMit:LOWer	143
CALCulate:LIMit:LOWer?	143
CALCulate:LIMit:UPPer	143
CALCulate:LIMit:UPPer?	143
CALCulate:LIMit:BEEPer:MODE	143
CALCulate:LIMit:BEEPer:MODE?.....	143
CALCulate:DB:REFerence	143

CALCulate:DB:REference?	143
CALCulate:DB:REference:MEthod	143
CALCulate:DB:REference:MEthod?	143
CALCulate:DBM:REference	144
CALCulate:DBM:REference?	144
CALCulate:MATH:MMFactor	144
CALCulate:MATH:MMFactor?	144
CALCulate:MATH:MBFactor	144
CALCulate:MATH:MBFactor?.....	144
CALCulate:MATH:PERCent	144
CALCulate:MATH:PERCent?.....	144

Trigger Commands

READ?.....	145
VAL1?	145
VAL2?	145
TRIGger:SOURce	145
TRIGger:SOURce?.....	145
TRIGger:AUTO	145
TRIGger:AUTO?	145
SAMPlE:COUNT.....	145
SAMPlE:COUNT?.....	146
TRIGger:COUNT	146
TRIGger:COUNT?	146

Display Commands

DISPlay[:STATe]	146
DISPlay[:STATe]?	146
DISPlay:TEXT:CLEar	146
DISPlay:TEXT[:DATA].....	146
DISPlay:TEXT[:DATA]?	146

DIGital IO Commands

DIGitalio:MODE	147
DIGitalio:MODE?	147
DIGitalio[1 2 3 4]:SETup	147
DIGitalio[1 2 3 4]:SETup?	147

System Commands

SYSTem:BEEPer:STATe	148
SYSTem:BEEPer:STATe?	148
SYSTem:BEEPer:ERRor	148
SYSTem:BEEPer:ERRor?	148
SYSTem:BEEPer:COMPare:VOLume	148
SYSTem:BEEPer:COMPare:VOLume?	148
SYSTem:BEEPer:CONTInuity:VOLume	148
SYSTem:BEEPer:CONTInuity:VOLume?	148
SYSTem:BEEPer:HOLD:VOLume	148
SYSTem:BEEPer:HOLD:VOLume?	149
SYSTem:CLICk:STATe	149
SYSTem:CLICk:STATe?	149
SYSTem:DATE	149
SYSTem:DATE?	149
SYSTem:DISPlay	149
SYSTem:DISPlay?	149
SYSTem:ERRor?	149
SYSTem:SCPi:MODE	149
SYSTem:SCPi:MODE?	149
SYSTem:SERial?	150
SYSTem:TIME	150
SYSTem:TIME?	150
SYSTem:UPTime?	150
SYSTem:VERSion?	150

Status Commands

STATus:QUEStionable:ENABle	151
STATus:QUEStionable:ENABle?	151
STATus:QUEStionable:EVENT?	151
STATus:PRESet	151

Interface Commands

SYSTem:LOCAl	151
SYSTem:REMote	151
SYSTem:RWLock	151

Common Commands

*CLS.....	152
*ESE?.....	152
*ESE.....	152
*ESR?	152
*IDN?	152
*OPC?.....	152
*OPC	152
*PSC?	152
*PSC	152
*RST	152
*SRE?	153
*SRE	153
*STB?	153
*TRG.....	153

CONFigure Commands(1st)

CONFigure:VOLTage:DC

Sets measurement to DC Voltage on the 1st display and specifies the range.

Parameter: [None] | [Range(<NRf> | MIN | MAX | DEF)]

Example: CONF:VOLT:DC 2

Sets the voltage range to 2 volts.

CONFigure:VOLTage:AC

Sets measurement to AC Voltage on the 1st display and specifies the range.

Parameter: [None] | [Range(<NRf> | MIN | MAX | DEF)]

Example: CONF:VOLT:AC

Sets the AC range to auto range.

CONFigure:CURRent:DC

Sets measurement to DC Current on the 1st display and specifies the range.

Parameter: [None] | [Range(<NRf> | MIN | MAX | DEF)]

Example: CONF:CURR:DC 20e-3

Sets the DC current range to 20 mA.

CONFigure:CURRent:AC

Sets measurement to AC Current on the 1st display and specifies range.

Parameter: [None] | [Range(<NRf> | MIN | MAX | DEF)]

Example: CONF:CURR:AC 20e-2

Sets the measurement mode to ACI with a 200 mA range.

CONFigure:RESistance

Sets measurement to 2W Resistance on the 1st display and specifies range.

Parameter: [None] | [Range(<NRf> | MIN | MAX | DEF)]

Example: CONF:RES 20e3

Sets the range to 20 k Ω .

CONFigure:FRESistance

Sets measurement to 4W Resistance on the 1st display and specifies range.

Parameter: [None] | [Range(<NRf> | MIN | MAX | DEF)]

Example: CONF:FRES 20e3

Sets the range to 20 k Ω .

CONFigure:FREQuency

Sets measurement to Frequency on the 1st display and specifies the range.

Parameter: [None] | [Range(<NRf> | MIN | MAX | DEF)]

Example: CONF:FREQ MAX

Sets the frequency measurement range to max.

CONFigure:PERiod

Sets measurement to Period on the 1st display and specifies the range.

Parameter: [None] | [Range(<NRf> | MIN | MAX | DEF)]

Example: CONF:PER

Sets the DMM to period measurement using the previous range.

CONFigure:CONTinuity

Sets measurement to Continuity on the 1st display.

Parameter: None

CONFigure:DIODE

Sets measurement to Diode on the 1st display.

Parameter: None

CONFigure:TEMPerature:TCouple

Sets measurement to Temperature thermocouple (T-CUP) on the 1st display.

Parameter: [None] | [Type(J | K | T)]

Example: CONF:TEMP:TCO J

Sets the measurement mode to TCO with a type J sensor.

CONFigure:CAPacitance

Sets measurement to Capacitance on the 1st display.

Parameter: [None] | [Range(<NRf> | MIN | MAX | DEF)]

Example: CONF:CAP 10E-6

Sets the measurement mode to Capacitance with a 10 μ F Range.

CONFigure:FUNCTION?

Returns the current function on the 1st display.

Return parameter: VOLT, VOLT:AC, CURR, CURR:AC, RES, FRES, FREQ, PER, TEMP, DIOD, CONT, CAP

CONFigure:RANGe?

Returns the current range on the 1st display.

Return Parameter:

DCV: 0.2(200 mV), 2(2 V), 20(20 V), 200(200 V), 1000(1000 V)

ACV: 0.2(200 mV), 2(2 V), 20(20 V), 200(200 V), 750(750 V)

DCI: 0.02(20 mA), 0.2(200 mA), 2(2 A), 10(10 A)

ACI: 0.02(20 mA), 0.2(200 mA), 2(2 A), 10(10 A)

RES: 20E+1(200 Ω), 20E+2(2 k Ω), 20E+3(20 k Ω), 20E+4 (200 k Ω), 20E+5(2 M Ω),
10E+6(10 M Ω) , 10E+7(100 M Ω)

FRES: 20E+1(200 Ω), 20E+2(2 k Ω), 20E+3(20 k Ω), 20E+4 (200 k Ω), 20E+5(2 M Ω),
10E+6(10 M Ω) , 10E+7(100 M Ω)

CAP: 10E-9(10 nF), 10E-8(100 nF), 10E-7(1 μ F), 10E-6(10 μ F), 10E-5(100 μ F)

CONFigure:AUTO

Sets Auto-Range on or off on the 1st display.

Parameter: 0 | 1 | ON | OFF

Example: CONF:AUTO ON

CONFigure:AUTO?

Returns the Auto-Range status of the function on the 1st display.

Return Parameter: 0 | 1, 1=Auto range, 0=Manual range

CONFigure2 Commands(2nd)

CONFigure2:VOLTage:DC

Sets measurement to DC Voltage on the 2nd display and specifies the range.

Parameter: [None] | [Range(<NRf> | MIN | MAX | DEF)]

Example: CONF2:VOLT:DC 2

Sets the voltage range to 2 volts.

CONFigure2:VOLTage:AC

Sets measurement to AC Voltage on the 2nd display and specifies the range.

Parameter: [None] | [Range(<NRf> | MIN | MAX | DEF)]

Example: CONF2:VOLT:AC

Sets the measurement mode to AC voltage.

CONFigure2:CURREnt:DC

Sets measurement to DC Current on the 2nd display and specifies the range.

Parameter: [None] | [Range(<NRf> | MIN | MAX | DEF)]

Example: CONF2:CURR:DC 20e-3

Sets the DC current range to 20 mA on the second display.

CONFigure2:CURREnt:AC

Sets measurement to AC Current on the 2nd display and specifies the range.

Parameter: [None] | [Range(<NRf> | MIN | MAX | DEF)]

Example: CONF2:CURR:AC 20e-2

Sets the measurement mode to ACI with a 200 mA range on the second display.

CONFigure2:RESistance

Sets measurement to 2W Resistance on the 2nd display and specifies the range.

Parameter: [None] | [Range(<NRf> | MIN | MAX | DEF)]

Example: CONF2:RES 20e3

Sets the range to 20 k Ω on the second display.

CONFigure2:FRESistance

Sets measurement to 4W Resistance on the 2nd display and specifies the range.

Parameter: [None] | [Range(<NRf> | MIN | MAX | DEF)]

Example: CONF2:FRES 20e2

Sets the range to 2 k Ω on the second display.

CONFigure2:FREQuency

Sets measurement to Frequency on the 2nd display and specifies the range.

Parameter: [None] | [Range(<NRf> | MIN | MAX | DEF)]

Example: CONF2:FREQ MAX

Sets the frequency measurement range to max on the second display.

CONFigure2:PERiod

Sets measurement to Period on the 2nd display and specifies the range.

Parameter: [None] | [Range(<NRf> | MIN | MAX | DEF)]

Example: CONF2:PER

Sets the DMM to period measurement using the previous range.

CONFigure2:OFF

Turns the 2nd display function off.

Parameter: None.

CONFigure2:FUNcTION?

Returns the current function on the 2nd display.

Return parameter: VOLT, VOLT:AC, CURR, CURR:AC, RES, FRES, FREQ, PER, NON

CONFigure2:RANGe?

Returns the range of the current function on the 2nd display.

Return parameter:

DCV: 0.2(200 mV), 2(2 V), 20(20 V), 200(200 V), 1000(1000 V)

ACV: 0.2(200 mV), 2(2 V), 20(20 V), 200(200 V), 750(750 V)

DCI: 0.02(20 mA), 0.2(200 mA), 2(2 A), 10(10 A)

ACI: 0.02(20 mA), 0.2(200 mA), 2(2 A), 10(10 A)

RES: 20E+1(200 Ω) 20E+2(2 kΩ), 20E+3(20 kΩ), 20E+4 (200 kΩ), 20E+5(2 MΩ),
10E+6(10 MΩ), 10E+7(100 MΩ)

FRES: 20E+1(200 Ω) 20E+2(2 kΩ), 20E+3(20 kΩ), 20E+4 (200 kΩ), 20E+5(2 MΩ),
10E+6(10 MΩ), 10E+7(100 MΩ)

CONFigure2:AUTO

Sets Auto-Range on or off on the 2nd display.

Parameter: 0 | 1 | ON | OFF

Example: CONF2:AUTO ON

CONFigure2:AUTO?

Returns the Auto-Range status of the function on the 2nd display.

Return Parameter: 0 | 1, 1=Auto range, 0=Manual range

Measure Commands

MEASure:VOLTage:DC?

Returns the DC voltage measurement on the 1st display.

Parameter: [None] | [Range(<NRf> | MIN | MAX | DEF)]

Example: MEAS:VOLT:DC?

> +0.48280E-04

Returns the DC voltage measurement as 0.04828 mV.

MEASure:VOLTage:AC?

Returns the AC voltage measurement on the 1st display.

Parameter: [None] | [Range(<NRf> | MIN | MAX | DEF)]

Example: MEAS:VOLT:AC?

> +0.51210E-03

Returns the AC voltage measurement as 0.5121 mV.

MEASure:CURREnt:DC?

Returns the DC current measurement on the 1st display.

Parameter: [None] | [Range(<NRf> | MIN | MAX | DEF)]

Example: MEAS:CURR:DC?

> +0.23240E-04

Returns the DC current measurement as 0.02324 mA.

MEASure:CURREnt:AC?

Returns the AC current measurement on the 1st display.

Parameter: [None] | [Range(<NRf> | MIN | MAX | DEF)]

Example: MEAS:CURR:AC?

> +1.38272E-02

Returns the AC current measurement as 13.8272 mA.

MEASure:RESistance?

Returns the 2W resistance measurement on the 1st display.

Parameter: [None] | [Range(<NRf> | MIN | MAX | DEF)]

Example: MEAS:RES?

> +1.19237E+03

Returns the 2W measurement as 1.19237 k Ω .

MEASure:FRESistance?

Returns the 4W resistance measurement on the 1st display.

Parameter: [None] | [Range(<NRf> | MIN | MAX | DEF)]

Example: MEAS:RES?

> +1.92371E+03

Returns the 4W measurement as 1.92371 k Ω .

MEASure:FREQuency?

Returns the frequency measurement on the 1st display.

Parameter: [None] | [Range(<NRf> | MIN | MAX | DEF)]

Example: MEAS:FREQ?

> +2.37208E+02

Returns the frequency (237.208 Hz).

MEASure:PERiod?

Returns the period measurement on the 1st display.

Parameter: [None] | [Range(<NRf> | MIN | MAX | DEF)]

Example: MEAS:PER? MAX

Returns the period at the maximum range.

MEASure:CONTInuity?

Returns the continuity measurement on the 1st display.

Example: MEAS:CONT?

Returns the continuity.

MEASure:DIODE?

Returns the diode measurement on the 1st display.

Example: MEAS:DIOD?

Returns the diode measurement.

MEASure:TEMPerature:TCouple?

Returns the temperature for the selected thermocouple type on the 1st display.

Parameter:[NONE] | J | K | T

Example: MEAS:TEMP:TCO? J

> +2.50200E+01

Returns the temperature.

MEASure:CAPacitance?

Returns the capacitance measurement on the 1st display.

Parameter: [None] | [Range(<NRf> | MIN | MAX | DEF)]

Example: MEAS:CAP?

Returns the capacitance measurement.

MEASure2:VOLTage:DC?

Returns the DC voltage measurement on the 2nd display.

Parameter: [None] | [Range(<NRf> | MIN | MAX | DEF)]

Example: MEAS2:VOLT:DC?

> +0.48280E-04

Returns the DC voltage measurement as 0.04828 mV.

MEASure2:VOLTage:AC?

Returns the AC voltage measurement on the 2nd display.

Parameter: [None] | [Range(<NRf> | MIN | MAX | DEF)]

Example: MEAS2:VOLT:AC?

> +0.51210E-03

Returns the AC voltage measurement as 0.5121 mV.

MEASure2:CURRent:DC?

Returns the DC current measurement on the 2nd display.

Parameter: [None] | [Range(<NRf> | MIN | MAX | DEF)]

Example: MEAS2:CURR:DC?

> +0.23240E-04

Returns the DC current measurement as 0.02324 mA.

MEASure2:CURRent:AC?

Returns the AC current measurement on the 2nd display.

Parameter: [None] | [Range(<NRf> | MIN | MAX | DEF)]

Example: MEAS2:CURR:AC?

> +0.38270E-02

Returns the AC current measurement as 3.827 mA.

MEASure2:RESistance?

Returns the 2W resistance measurement on the 2nd display.

Parameter: [None] | [Range(<NRf> | MIN | MAX | DEF)]

Example: MEAS2:RES?

> +1.19212E+03

Returns the 2W measurement as 1.19212 k Ω .

MEASure2:FRESistance?

Returns the 4W resistance measurement on the 2nd display.

Parameter: [None] | [Range(<NRf> | MIN | MAX | DEF)]

Example: MEAS2:RES?

> +1.92121E+03

Returns the 4W measurement as 1.92121 k Ω .

MEASure2:FREQuency?

Returns the frequency measurement on the 2nd display.

Parameter: [None] | [Range(<NRf> | MIN | MAX | DEF)]

Example: MEAS2:FREQ?

> +2.37212E+02

Returns the frequency (237.212 Hz).

MEASure2:PERiod?

Returns the period measurement on the 2nd display.

Parameter: [None] | [Range(<NRf> | MIN | MAX | DEF)]

Example: MEAS2:PER? MAX

Returns the period at the maximum range.

SENSe Commands

[SENSe:]TEMPerature:TCouple:TYPE

Sets thermocouple type.

Parameter: Type(J | K | T)

Example: SENS:TEMP:TCO:TYPE J

Sets the thermocouple to type J.

[SENSe:]TEMPerature:TCouple:TYPE?

Returns the thermocouple type.

Return parameter: J, K, T

[SENSe:]TEMPerature:RJUNction:SIMulated

Set temperature simulation value.

Parameter: <NRf>(0.00 ~ 50.00)

Example: SENS:TEMP:RJUN:SIM 25.00

Sets the thermocouple junction temperature to 25 °C.

[SENSe:]TEMPerature:RJUNction:SIMulated?

Returns temperature simulation value.

Return parameter: <NR1> (+0000~+5000) ,where +0000=0.00 °C, +5000=50.00 °C

[SENSe:]DETEctor:RATE

Sets the detection rate (sample rate)

Parameter: RATE(S | M | F)

Example: SENS:DET:RATE S

Sets the rate to slow (S).

[SENSe:]DETEctor:RATE?

Returns the sample rate.

Return parameter: SLOW, MID, FAST

[SENSe:]FREQuency:INPutjack

Assigns an input terminal for the frequency function.

Parameter: (0 | 1 | 2) 0=volt, 1=2 A, 2=10 A

Example: SENS:FREQ:INP 0

Sets the input jack to the Volt input terminal.

[SENSe:]FREQuency:INPutjack?

Returns the assigned input terminal used for the frequency function.

Return Parameter: VOLT, 2 A, 10 A

[SENSe:]PERiod:INPutjack

Assigns an input terminal for the period function.

Parameter: (0 | 1 | 2) 0=volt, 1=2 A, 2=10 A

Example: SENS:PER:INP 0

Sets the input jack to the Volt input terminal.

[SENSe:]PERiod:INPutjack?

Returns the assigned input terminal used for the period function.

Return Parameter: VOLT, 2 A, 10 A

[SENSe:]CONTInuity:THReshold

Sets the continuity threshold in ohms.

Parameter: <NR1> (0 ~ 1000)

Example: SENS:CONT:THR 500

Sets the continuity threshold to 500 Ω

[SENSe:]CONTInuity:THReshold?

Returns the continuity threshold.

[SENSe:]UNIT

Sets the temperature unit.

Parameter: C|F

Example: SENS:UNIT C

Sets the temperature unit to °C.

[SENSe:]UNIT?

Returns the temperature unit.

[SENSe:]FUNCTion[X]

Sets the function for the 1st or 2nd display, which X = 1 indicate 1st display, X = 2 indicate 2nd display.

Parameter:

(1st): "VOLT[:DC]", "VOLT:AC", "CURR[:DC]", "CURR:AC", "RES", "FRES", "FREQ", "PER", "TEMP:TCO", "DIOD", "CONT", "CAP"

(2nd): "VOLT[:DC]", "VOLT:AC", "CURR[:DC]", "CURR:AC", "RES", "FRES", "FREQ", "PER", "NON"

Example: SENS:FUNC1 "VOLT:DC"

Sets the 1st display to the DCV function.

[SENSe:]FUNCTion[X]?

Returns the function for the 1st or 2nd display, which X = 1 indicate 1st display, X = 2 indicate 2nd display.

Return parameter:

(1st): VOLT, VOLT:AC, CURR, CURR:AC, RES, FRES, FREQ, PER, TEMP:TCO, DIOD, CONT, CAP

(2nd): VOLT, VOLT:AC, CURR, CURR:AC, RES, FRES, FREQ, PER, NON

[SENSe:]DATA?

Returns the auxiliary measurement value.

[SENSe:]CAPacitance:CABLe:CALibration

It is used like Relative function before capacitance measurement, (only be used at range 10nF).

Parameter: [None]

Example: CONF:CAP 10e-9

SENS:CAP:CABL:CAL

Makes test lead to zero before capacitance measurement.

[SENSe:] VOLTage:DC:IMPedance:AUTO

Sets the Automatic input impedance for DC Voltage measurement.

Parameter: 0 | 1 | ON(10G) | OFF(10M)

Example: SENS:VOLT:DC:IMP:AUTO ON

Turns the Automatic input impedance on.

[SENSe:]VOLTage:DC:IMPedance:AUTO?

Returns the Automatic input impedance mode.

Return parameter: 0 | 1, 1=ON(10G), 0=OFF(10M)

[SENSe:] VOLTage:DC:IMPedance:EXTend

Sets the Hi input impedance mode for DC Voltage measurement.(only be used at range 20V).

Parameter: 0 | 1 | ON | OFF

Example: SENS:VOLT:DC:IMP:EXT ON

Turns the Hi input impedance on.

[SENSe:]VOLTage:DC:IMPedance:EXTend?

Returns the Hi input impedance mode.

Return parameter: 0 | 1, 1=ON, 0=OFF

[SENSe:]FILTer:COUNT

Sets the digital filter count.

Parameter: <NR1> (2 ~ 320) | MIN | MAX | DEF

Example: SENS:FILT:COUN 100

Sets digital filter count number to 100.

[SENSe:]FILTer:COUNT?

Returns the digital filter count.

Return parameter: <NR1>, Ex: +002

[SENSe:]FILTer:STATE

Turns the digital filter function On/Off.

Return parameter:

Parameter: 0 | 1 | ON | OFF

Example: SENS:FILT:STAT ON

Turns digital filter function on

[SENSe:]FILTer:STATE?

Returns the state of the digital filter function (on or off).

Return parameter: 0 | 1, 1=ON, 0=OFF

[SENSe:]FILTEr:TCONtrol

Selects the digital filter type.

Parameter: MOV | REP

Example: SENS:FILT:TCON MOV

Sets digital filter type to the moving filter.

[SENSe:]FILTEr:TCONtrol?

Returns the digital filter type.

Return parameter: MOV (moving) | REP (repeating)

[SENSe:]FILTEr:WINDow

Selects a digital filter window.

Parameters: 0.01 | 0.1 | 1 | 10 | NONE

Example: SENS:FILT:WIND 0.1

Sets digital filter window to 0.1 %

[SENSe:]FILTEr:WINDow?

Returns the digital filter window value.

Return parameter: 0.01 | 0.1 | 1 | 10 | NONE

CALCulate Commands

CALCulate:FUNCtion

Sets the Advanced function.

Parameter: OFF | MIN | MAX | HOLD | REL | COMP | DB | DBM | MXB | INV | REF

Example: CALC:FUNC REL

Sets the Advanced function to REL (relative)

CALCulate:FUNCtion?

Returns the current Advanced function.

CALCulate:STATe

Turns the Advanced function on/off.

Parameter: 0 | 1 | ON | OFF

Example: CALC:STAT OFF

Turns the Advanced function off.

CALCulate:STATe?

Returns the status of the Advanced function.

Return Parameter: 0 | 1, 1=ON, 0=OFF

CALCulate:MINimum?

Returns the minimum value from the Max/Min measurement.

CALCulate:MAXimum?

Returns the maximum value from the Max/Min measurement.

CALCulate:HOLD:REFerence

Sets the percentage threshold for the Hold function.

Parameter: <NRf> (0.01, 0.1, 1, 10)

Example: CALC:HOLD:REF 10

Sets the hold percentage to 10 %.

CALCulate:HOLD:REFerence?

Returns the percentage threshold from the Hold function.

CALCulate:REL:REFerence

Sets the reference value for the relative function.

Parameter: <NRf> | MIN | MAX

Example: CALC:REL:REF MAX

Sets the reference value to the maximum allowed.

CALCulate:REL:REFerence?

Returns the reference value from the relative function.

CALCulate:LIMit:LOWer

Sets the lower limit of the compare function.

Parameter: <NRf> | MIN | MAX

Example: CALC:LIM:LOW 1.0

Sets the lower limit to 1.0

CALCulate:LIMit:LOWer?

Returns the lower limit of the compare function.

CALCulate:LIMit:UPPer

Sets the upper limit of the compare function.

Parameter: <NRf> | MIN | MAX

Example: CALC:LIM:UPP 1.0

Sets the upper limit to 1.0

CALCulate:LIMit:UPPer?

Returns the upper limit of the compare function.

CALCulate:LIMit:BEEPer:MODE

Sets the beeper alarm mode of the compare function.

Parameter: <NR1> (0~2) 0(OFF), 1(PASS), 2(FAIL)

Example: CALC:LIM:BEEP:MODE PASS

Sets the pass alarm to compare function.

CALCulate:LIMit:BEEPer:MODE?

Returns the beeper alarm mode of the compare function.

Return Parameter: OFF | PASS | FAIL

CALCulate:DB:REFErrence

Sets the reference value for the dB function.

Parameter: <NRf> | MIN | MAX

Example: CALC:DB:REF MAX

Sets the reference voltage for dB measurements to the maximum allowed.

CALCulate:DB:REFErrence?

Returns the reference voltage from the dB function.

CALCulate:DB:REFErrence:METHod

Sets the unit of reference value for the dB function.

Parameter: DBM | VOLTage

Example: CALC:DB:REF:METH DBM

Sets the unit to dbm of reference value for dB function.

CALCulate:DB:REFErrence:METHod?

Returns the unit of reference value from the dB function.

Return parameter: dBm | Voltage

CALCulate:DBM:REference

Sets the resistance value for the dBm function.

Parameter: <NR1> (2, 4, 8, 16, 50, 75, 93, 110, 124, 125, 135, 150, 250, 300, 500, 600, 800, 900, 1000, 1200, 8000) | MIN | MAX | DEF

Example: CALC:DBM:REF MAX

Sets the resistance value for dBm measurements to the maximum allowed.

CALCulate:DBM:REference?

Returns the resistance value from the dBm function.

CALCulate:MATH:MMFactor

Sets the scale factor M for math measurements.

Parameter: <NRf> | MIN | MAX

Example: CALC:MATH:MMF MIN

Sets the scale factor M to the minimum allowed value.

CALCulate:MATH:MMFactor?

Returns the scale factor M used in the math measurement.

CALCulate:MATH:MBFactor

Sets the offset factor B for math measurements.

Parameter: <NRf> | MIN | MAX

Example: CALC:MATH:MBF MIN

Sets the offset factor B to the minimum allowed value.

CALCulate:MATH:MBFactor?

Returns the offset factor B used in the math measurement.

CALCulate:MATH:PERCent

Sets the reference value for the Percent function.

Parameter: <NRf> | MIN | MAX

Example: CALC:MATH:PERC MAX

Sets the reference value for the Percent function to the maximum.

CALCulate:MATH:PERCent?

Returns the reference value setting for the Percent function.

TRIGger Commands

READ?

Returns 1st and 2nd display value.

VAL1?

Returns the 1st display reading

Example: SAMP:COUN 100

VAL1?

>+0.33231E-04,

>+0.38292E-04,

> etc, for 100 counts.

Queries 100 counts of stored samples from the 1st display.

VAL2?

Returns the 2nd display reading.

Example: SAMP:COUN 100

VAL2?

>+0.34253E-04,

>+0.39218E-04,

> etc, for 100 counts.

Queries 100 counts of stored samples from the 2nd display.

TRIGger:SOURce

Selects the trigger source.

Parameter: INT | SIN | EXT

Example: TRIG:SOUR INT

Sets the trigger source as internal.

TRIGger:SOURce?

Returns current trigger source.

TRIGger:AUTO

Turns Trigger Auto mode on/off.

Parameters: 0 | 1 | ON | OFF

Example: TRIG:AUTO OFF

Turns the Trigger Auto mode off.

TRIGger:AUTO?

Returns the Trigger Auto mode.

Return parameter: 0|1, 1=ON, 0=OFF

SAMPle:COUNT

Sets the number of samples.

Parameter: <NR1>(1 ~ 9999) | MIN | MAX

Example: SAMP:COUN 10

Sets the number of samples to 10.

SAMPlE:COUNT?

Returns the number of samples.

TRIGger:COUNT

Sets the number of trigger counts.

Parameter: <NR1>(1 ~ 9999) | MIN | MAX

Example: TRIG:COUN 10

Sets the number of trigger counts to 10.

TRIGger:COUNT?

Returns the number of trigger counts.

DISPlay Commands

DISPlay[:STATe]

Sets TFT LCD display screen on/off.

Parameter: 0 | 1 | ON | OFF

Example: DISP OFF

Turns the TFT LCD display screen OFF.

DISPlay[:STATe]?

Returns the TFT LCD display screen state.

Return parameter: 0 | 1, 1=ON, 0=OFF

DISPlay:TEXT:CLEAr

Clears the text message from the display.

- With DISP:STAT ON, DISP:TEXT:CLE returns the display to its normal mode.
 - With DISP:STAT OFF, DISP:TEXT:CLE clears the message and the display remains disabled. To enable the display, send DISPlay ON or press the front panel Shift key(Local).
-

DISPlay:TEXT[:DATA]

Sets the text message to TFT LCD display screen.

Parameter: "<message>", max length = 15 characters

Example: DISP:TEXT:DATA "testing"

Prints the testing characters to TFT LCD display screen.

DISPlay:TEXT[:DATA]?

Returns the text message of TFT LCD display screen.

Return parameter: "<message>", Ex: "testing".

DIGital IO Commands

DIGitalio:MODE

Sets the mode for Digital I/O.

Parameter: NORM | USER

Example: DIG:MODE NORM

Sets the Digital I/O Mode to normal.

DIGitalio:MODE?

Returns the Digital I/O mode.

Return parameter: NORM | USER

DIGitalio[1 | 2 | 3 | 4]:SETup

Sets the status for Digital I/O(only for user mode).

Parameter: 0 | 1 | ON | OFF

Example: DIG1:SET ON

Sets OUT1 to high

DIGitalio[1 | 2 | 3 | 4]:SETup?

Returns the Digital I/O status (only for User mode).

Return parameter: 0 | 1, 1=ON, 0=OFF.

SYSTEM Related Commands

SYSTEM:BEEPer:STATe

Turns the buzzer on/off.

Parameter: 0 | 1 | ON | OFF

Example: SYST:BEEP:STAT 0

Turns the buzzer off.

SYSTEM:BEEPer:STATe?

Returns the buzzer state.

Return parameter: 0 | 1, 1=ON, 0=OFF

SYSTEM:BEEPer:ERRor

Sets the beeper to sound on an SCPI error.

Parameter: 0 | 1 | ON | OFF

Example: SYST:BEEP:ERR ON

Allows the beeper to sound when an SCPI error occurs.

SYSTEM:BEEPer:ERRor?

Returns the beeper error mode.

Return parameter: 0 | 1, 1=ON, 0=OFF

SYSTEM:BEEPer:COMPare:VOLume

Sets the beeper volume of Compare function.

Parameter: <NR1> (0~2) 0(Small), 1(Medium) , 2(Large)

Example: SYST:BEEP:COMP:VOL 2

Sets the beeper volume to large of Compare function.

SYSTEM:BEEPer:COMPare:VOLume?

Returns the beeper volume of Compare function.

Return parameter: SMALL | MEDIUM | LARGE

SYSTEM:BEEPer:CONTInuity:VOLume

Sets the beeper volume of Continuity function.

Parameter: <NR1> (0~3) 0(Off), 1(Small), 2(Medium) , 3(Large)

Example: SYST:BEEP:CONT:VOL 1

Sets the beeper volume to small of Continuity function.

SYSTEM:BEEPer:CONTInuity:VOLume?

Returns the beeper volume of Continuity function.

Return parameter: OFF | SMALL | MEDIUM | LARGE

SYSTEM:BEEPer:HOLD:VOLume

Sets the beeper volume of Hold function.

Parameter: <NR1> (0~3) 0(Off), 1(Small), 2(Medium) , 3(Large)

Example: SYST:BEEP:HOLD:VOL 2

Sets the beeper volume to medium of Hold function.

SYSTem:BEEPer:HOLD:VOLume?

Returns the beeper volume of Hold function.

Return parameter: OFF | SMALL | MEDIUM | LARGE

SYSTem:CLICk:STATe

Turns the key sound of front panel on/off.

Parameter: 0 | 1 | ON | OFF

Example: SYST:CLIC:STAT 0

Turns key sound off.

SYSTem:CLICk:STATe?

Returns the key sound of front panel state.

Return parameter: 0|1, 1=ON, 0=OFF

SYSTem:DATE

Sets the date for the instrument's real-time clock.

Parameter: <NR1> (year, month, day)

Example: SYST:DATE 2025,02,25

Sets the date to 2025/2/25.

year: 2000~2099

month: 1~12

day: 1~31.

SYSTem:DATE?

Returns system date.

Return parameter: <Date>, Ex: 2025,2,25

SYSTem:DISPlay

Turns the Display on/off.

Parameter: 0 | 1 | ON | OFF

Example: SYST:DISP ON

Turns the display on.

SYSTem:DISPlay?

Returns the status of the display

Return parameter: 0|1, 1=ON, 0=OFF

SYSTem:ERRor?

Returns the current system error, if any.

SYSTem:SCPi:MODE

Sets the SCPI mode.

Parameter: NORM | 8351 | 8352

(NORM=Normal, 8351=GDM8351, 8352=GDM8352)

Example: SYST:SCP:MODE NORM

Sets the SCPI mode to normal.

SYSTem:SCPi:MODE?

Returns the SCPI mode.

Return parameter: NORMAL | 8351 | 8352

SYSTem:SERial?

Returns the serial number (nine characters/numbers)

SYSTem:TIME

Sets the time for the instrument's real-time clock.

Parameter: <NR1> (hour, minute, second)

Example: SYST:TIME 16,20,30

Sets the time to 16:20:30

hour: 0~23

minute: 0~59

second: 0~59

SYSTem:TIME?

Returns system time.

Return parameter: <Time>, Ex: 16:20:40

SYSTem:UPTime?

Returns the amount of time that the instrument has been running since the last power-on.

Return parameter: +0, +1, +25, +53 (day, hour, minute, second)

SYSTem:VERSion?

Returns SCPI version.

Return parameter: 1994.0.

STATus Report Commands

STATus:QUEStionable:ENABle

Set bits in the Questionable Data Enable register.

STATus:QUEStionable:ENABle?

Returns the contents of the Questionable Data Enable register.

STATus:QUEStionable:EVENT?

Returns the contents of the Questionable Data Event register.

STATus:PRESet

Clears the Questionable Data Enable register.

Example: STAT:PRES

Interface Commands

SYSTem:LOCAl

Enables local control (front panel control) and disables remote control.

SYSTem:REMote

Enables remote control and disables local control (front panel control, all key are disable except Shift key(return to local control)).

SYSTem:RWLock

Enables remote control and disables local control (front panel control, all key are disable).The only way to return local mode is to issue the SYSTem:LOCAl command.

IEEE 488.2 Common Commands

*CLS

Clears the Event Status register (Output Queue, Operation Event Status, Questionable Event Status, Standard Event Status)

*ESE?

Returns the ESER (Event Status Enable Register) contents.

Example: *ESE?

>130

Returns 130. ESER=10000010

*ESE

Sets the ESER contents.

Parameter: <NR1> (0~255)

Example: *ESE 65

Sets the ESER to 01000001

*ESR?

Returns SESR (Standard Event Status Register) contents.

Example: *ESR?

>198

Returns 198. SESR=11000110

*IDN?

Returns the manufacturer, model No., serial number and system version number.

Example: *IDN?

>GWInstek,GDM-9052,000000000,1.00

*OPC?

"1" is placed in the output queue when all the pending operations are completed.

*OPC

Sets operation complete bit (bit0) in SERS (Standard Event Status Register) when all pending operations are completed.

*PSC?

Returns power On clear status.

Return parameter: <Boolean>(0|1) 0= don't clear, 1=clear

*PSC

Clears power On status.

Parameter: <Boolean>(0|1) 0=don't clear, 1= clear

*RST

Recalls default panel setup.

***SRE?**

Returns the SRER (Service Request Enable Register) contents.

***SRE**

Sets SRER contents.

Parameter: <NR1>(0~255)

Example: *SRE 7

Sets the SRER to 00000111.

***STB?**

Returns the SBR (Status Byte Register) contents.

Example:*STB?

>81

Returns the contents of the SBR as 01010001.

***TRG**

Manually triggers the DMM.

For the following command sets, please refer to the status system diagram on page 154.

STAT:QUES:EVEN?

STAT:QUES:ENAB

STAT:QUES:ENAB?

*ESR?

*ESE

*ESE?

*STB?

*SRE

*SRE?

**Note**

By sending the query command, STAT:QUES:EVEN?, user can obtain the judgements from Compare function as follows:

- When compare judgement is PASS, it returns "00000".
 - When compare judgement is High, it returns "04097".
 - When compare judgement is Low, it returns "02049".
-

Status system

The diagram below is a description of the status system

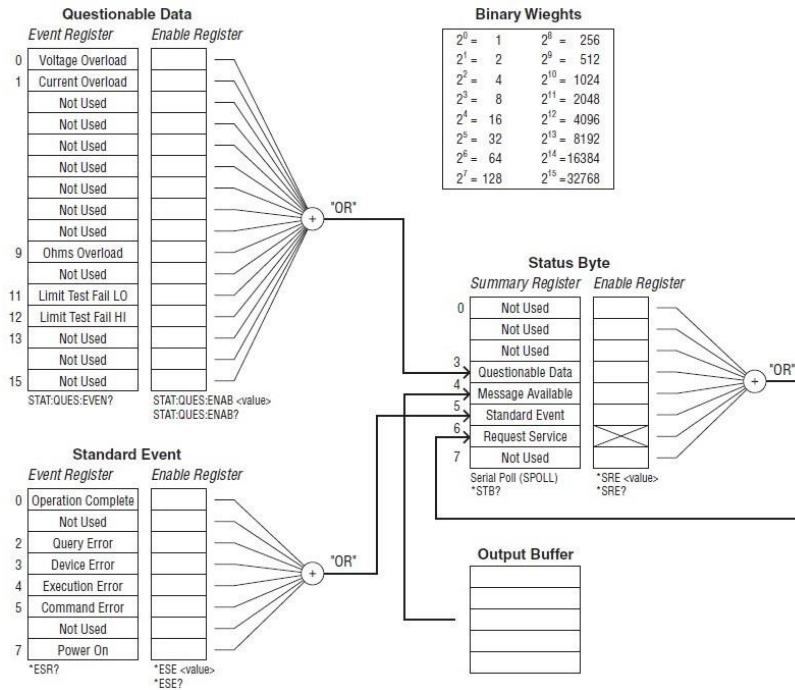

For the following command sets, please refer to the diagram above.

- STAT: QUES: EVEN?
- STAT: QUES: ENAB
- STAT: QUES: ENAB?
- *ESR?
- *ESE
- *ESE?
- *STB?
- *SRE
- *SRE?

APPENDIX

Fuse Replacement	157
Replace AC Source Fuse.....	157
Replace 2A Input Current Fuse.....	158
Replace Internal 10 A Input Current Fuse	159
Battery Replacement	161
Factory Default Parameters	163
Specifications	166
General Specifications	166
DC Voltage	167
DC Current.....	167
Diode	167
Continuity.....	167
Resistance ^[1] ^[2]	168
AC Voltage ^[1] ^[2]	168
AC Current.....	169
Frequency Accuracy	169
Thermocouple Specifications	170
Capacitance	170
Additional Specifications	171
DC Voltage	171
DC Current.....	171
AC Voltage (AC Coupling Mode/AC + DC Coupling Mode)	172
AC Current (AC Coupling Mode/AC + DC Coupling Mode)	173
Resistance (2-wire resistance and 4-wire resistance)	174
Diode	174
Continuity.....	174
Frequency.....	175
Capacitance	175
Measurement Noise Rejection	176
Temperature Coefficients	176

Dimensions..... 177

Declaration of Conformity 178

Fuse Replacement

Replace AC Source Fuse

Steps Remove the power cord followed by taking out the fuse box via using a small screw driver.

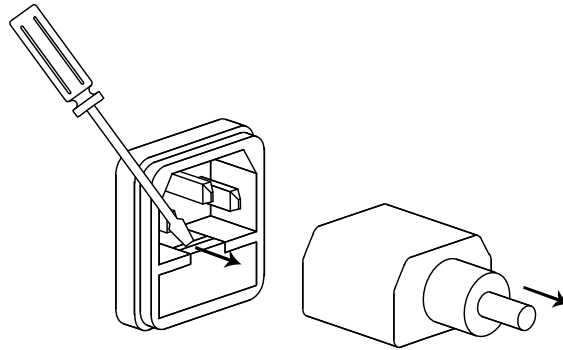

The AC source fuse is stored within the housing.

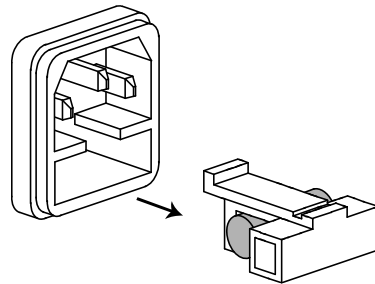

Rating

- 100 V/ 120 VAC: T0.315 A
- 220 V/ 240 VAC: T0.16 A

Replace 2A Input Current Fuse

Preparation To make sure if 2 A input current needs to be replaced, press the **•))** button to set GDM-9052 in Continuity mode and short circuit the HI input terminal with the 2A input current terminal.

If the test result shows OPEN, the fuse, which is accessible from the rear panel, requires replacement.

If the fuse of 2 A input current is damaged, please first check the one (2.5 A, 1000 V) in the upper-left corner of rear panel.

- Step**
1. Turn the instrument off
 2. Remove the fuse cover by loosening the screw, and the fuse holder is shown accordingly.

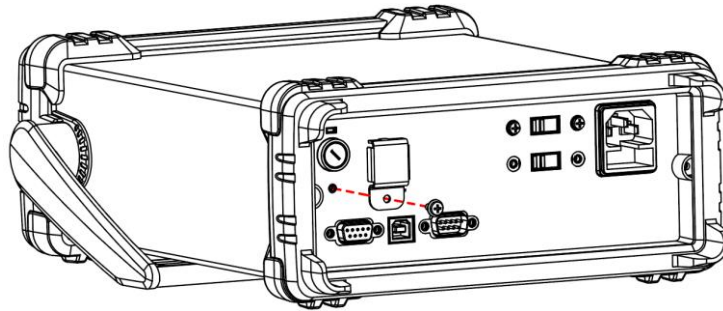

3. Press and hold the fuse holder in the rear panel followed by rotating it counterclockwise with a flat-blade screwdriver.

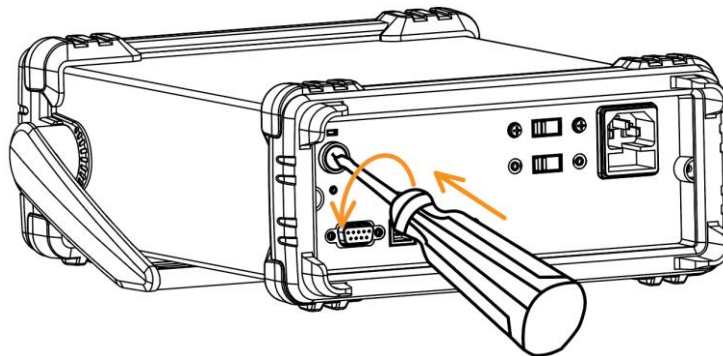

- The fuse holder comes out. Replace the fuse inserted at the end of the holder followed by rotating the fuser holder clockwise to fasten it firmly.

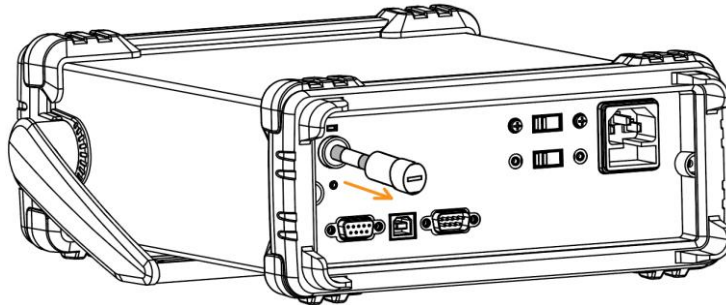

Rating T2.5 A, 1000 V, 6*30 mm

Replace Internal 10 A Input Current Fuse

Preparation **Replace internal 10A input fuse** To make sure if 10 A input current needs to be replaced, press the **•))** button to set GDM-9052 in Continuity mode and short circuit the HI input terminal with the 10 A input current terminal. If the test result shows OPEN, follow the following section to replace fuse of internal 10 A input current.

Internal Fuse Spec	Location	Current	Voltage	Type	Dimension
Internal 10 A input current fuse	F201	12 A	1000 V	Fast-blo w type	10 x 38 mm

- Steps for Internal Fuse**
- Power off properly and disconnect all the test leads, cables including power cord.

Replacement

-
2. Disassemble the instrument case in light of the disassembling instructions.
-
3. Make sure the certain fuse to be replaced as the figures below shown.

Internal 10 A
input current fuse



-
4. Pull the fuse out from the fuse holder with a flat-blade screwdriver. Be cautious Not to damage the printed circuit board (PCB).
-
5. Disassemble the fuse.
-
6. Place the new fuse into the fuse holder. Gently push the fuse downwards to make it firmly fixed within the fuse holder.
-
7. Reassemble the instrument properly followed by connecting all the cables and cords.
-
8. Fuse replacement is completed.

Battery Replacement

Beforehand

This chapter describes the procedure of battery replacement in the front panel.

Before start, it is required to let a certified and trained technician properly aware of potential risks to disassemble instrument case. Unplug power cord and disconnect external circuit from the instrument before opening the case. Some of the electrical connections are dynamic and even available after powering off the instrument.

Consequently, Do disconnect all the inputs, cords and cables before disassembling the instrument.

The steps to replace battery

1. Power off properly and disconnect all the test leads, cables including power cord.

2. Disassemble the instrument case in light of the disassembling instructions.

3. Find the battery (CR2032) on the main board, which is perfectly located in the BT101 behind the transformer.

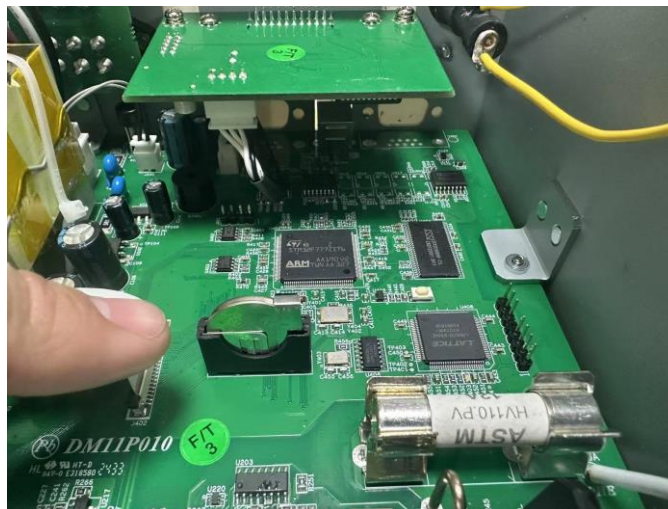





4. Gently remove the metal guard plate on top of the battery followed by pinching the battery out off the compartment with 2 fingers..



5. Remove the battery and dispose or recycle it in accord with the applicable regulations.
6. Place the new battery (CR2032) into the compartment and beware of the polarity (+, -). “+” is way close to the metal guard plate. Gently press the battery downwards to make it firmly fixed.
7. Connect every cable and cord in need and reassemble the instrument in proper order. The procedure of battery replacement is completed.

Factory Default Parameters

Measurement			
Item List	Factory Default Parameter	Parameter	
1ST Function	DCV	✓	
1ST Range	Auto Range	✓	
1ST Speed	10 /s	✓	
2ND Function	Off	✓	
Filter	Off	✓	
Filter Type	Move	✓	
Filter Count	10	✓	
Filter Windows	0.10 %	✓	
Input Impedance	10 M (fixed for DCV)	✓	
Freq GateTime	1 s	✓	
Freq InJack	Voltage	✓	
Continuity Threshold	10 Ω	✓	
Continuity Beep Volume	Small	✓	
Temperature			
Item List	Factory Default Parameter	Parameter	
Probe	Themocouple	✓	
Unit	°C	✓	
Themocouple	Type	J	
	Simulated junction	23	

Math			
Item List	Factory Default	Parameter	
Math Function	Off		✓
	Function	Off	✓
Hold	Beep Volume	Small	✓
	Threshold	0.10 %	✓
Rel	Function	Off	✓
dB	Reference Method	dBm	✓
	Reference Resistance	600 Ω	✓
dBm	Reference Resistance	600 Ω	✓
Compare	Beep Mode	Off	✓
	Beep Volume	Medium	✓
	Low Limit	-1	✓
	High Limit	1	✓
MX+B	M Value	1	✓
	B Value	0	✓
Trigger			
Item List	Factory Default	Parameter	
	Trigger Source	INT	✓
	Sample Count	1	✓

Menu			
Item List		Factory Default Parameter	Parameter
System	Beep	On	✓
	Key Sound	On	✓
	Brightness	50 %	✓
	Auto Dim	OFF	✓
	Zero Fill	On	✓
	Factory	Off	✓
Interface	Interface	USB	✓
	USB Protocol	USBCDC	✓
	BaudRate	115200	✓
	EOL Character	CR+LF	✓
	Separation Character	Comma	✓
	Identity	Normal	✓



Only utilized parameters are listed here due to over-amount parameters. The rest of the parameters unlisted, however, can be saved and loaded as well.



It indicates parameters can be saved and loaded.

Specifications

The specifications apply when the DMM is warmed up for at least 30 minutes and operates in the slow rate.

Below are the basic conditions required to operate the DMM within specifications:

- Calibration: Yearly
- Accuracy: \pm (% of Reading + Digits)
- The power supply cable must be grounded to ensure accuracy.
- All specifications are applicable to the main (1st) display only.

General Specifications

Specification Conditions:

Temperature: 23 °C \pm 5 °C

Humidity: < 80 %RH, 75 %RH for resistance measurement readings greater than 10 M Ω

Operating Environment: (0 °C to 50 °C)

Temperature Range:

< 30 °C, Relative Humidity: < 80 %RH(non-condensing);

30 °C to 40 °C, Relative Humidity: < 70 %RH(non-condensing);

> 40 °C, Relative Humidity: < 50 %RH(non-condensing)

Indoor use only

Altitude: 2000 meters

Pollution degree 2

Storage Conditions (-40 °C to 70 °C)

Temperature Range: (-40 °C to 70 °C),

Relative Humidity: < 90 %RH(non-condensing)

General:

AC Input voltage: 100 V / 120 V / 220 V / 240 VAC, 50 Hz / 60 Hz. The power supply voltage should not fluctuate more than 10 %.

Power Consumption: Max 30 VA

Dimensions: 107 (H) mm X 268 (D) mm X 302 (W) mm

Weight: Approximately 3.2 kg

DC Voltage

Range ^[1]	Resolution	Full Scale	Accuracy
200.000 mV	0.001 mV	239.999	0.012 % + 8
2.00000 V	0.00001 V	2.39999	0.012 % + 5
20.0000 V	0.0001 V	23.9999	0.012 % + 5
200.000 V	0.001 V	239.999	0.012 % + 5
1000.00 V ^[2]	0.01 V	1020.00	0.012 % + 5

[1] When the input value exceeds the full scale of the selected range, the display will show -OL- (over load) on the display.

[2] The specifications are guaranteed to an input voltage of 1000 V. A beeping alarm will go off when the input voltage is higher than 1000 V.

DC Current

Range ^[1]	Resolution	full scale	Accuracy
20.0000 mA	0.0001 mA	23.9999	0.05 % + 15
200.000 mA	0.001 mA	239.999	0.05 % + 5
2.00000 A	0.00001 A	2.39999	0.2 % + 5
10.0000 A ^[2]	0.0001 A	11.9999	0.2 % + 5

[1] When the input value exceeds the full scale of the selected range, the display will show -OL- (over load) on the display.

[2] The specifications are guaranteed to an input of 10 A. A beeping alarm will go off when the input value is higher than 10 A.

Diode

Range	Resolution	Maximum reading	Accuracy
6 V	0.0001 V	5.9999 V	0.05 % + 15

*The diode test Current is 1 mA.

*Accuracy specifications are for the voltage measured at the input terminals only.

Continuity

Range	Resolution	Maximum reading	Accuracy
2000.00 Ω	0.01 Ω	2399.99	0.05 % + 5

* Without REL function, add 0.2 Ω additional error.

Resistance ^[1] ^[2]

Range	Resolution	full scale	Current source	Accuracy (4W)
200.000 Ω	0.001 Ω	239.999	1 mA	0.05 % + 8
2.00000 kΩ	0.00001 kΩ	2.39999	1 mA	0.05 % + 5
20.0000 kΩ	0.0001 kΩ	23.9999	100 μA	0.05 % + 5
200.000 kΩ	0.001 kΩ	239.999	10 μA	0.05 % + 5
2.00000 MΩ	0.00001 MΩ	2.39999	1 μA	0.05 % + 5
10.0000 MΩ	0.0001 MΩ	11.9999	0.5 μA	0.3 % + 5
100.000 MΩ	0.001 MΩ	119.999	0.5 μA//10 MΩ	3.0 % + 8

[1] Specifications are for 4-wire resistance measurement, or 2-wire resistance measurement using the REL function. Without the REL function, add 0.2 Ω additional error when using 2-wire resistance measurement.

[2] When measuring resistances greater than 500 kΩ, please use shielded test leads to eliminate the noise interference that may be induced by standard test leads.

AC Voltage ^[1] ^[2]

Range	Resolution	Full Scale	20 Hz to 45 Hz	45 Hz to 10kHz	10 kHz to 30 kHz	30 kHz to 100 kHz
200.000mV	0.001 mV	239.999	1 % + 100	0.3 % + 100	1.5 % +300	5 % + 300
2.00000 V	0.00001 V	2.39999	1 % + 100	0.2 % + 100	1 % +100	3 % + 200
20.0000 V	0.0001 V	23.9999	1 % + 100	0.2 % + 100	1 % +100	3 % + 200
200.000 V	0.001 V	239.999	1 % + 100	0.2 % + 100	1 % +100	3 % + 200
750.00 V ^[3]	0.01 V	765.00	1 % + 100	0.2 % + 100	1 % +100	3 % + 200

[1] Specifications are for sine wave inputs that are greater than 5 % range.

[2] Rate in Fast, Input ACV Frequency > 200 Hz.

[3] The specifications are guaranteed to an input of 750 V. A beeping alarm will go off when the input value is higher than 750 V.

AC Current

Range ^{[1][3]}	Resolution	Full Scale	Accuracy		
			20 Hz to 45 Hz	45 Hz to 2 kHz	2 kHz to 10kHz
20.0000 mA	0.0001 mA	23.9999	1.5 % + 100	0.5 % + 100	2 % + 200
200.000 mA	0.001 mA	239.999	1.5 % + 100	0.5 % + 100	2 % + 200
2.00000 A	0.00001 A	2.39999	1.5 % + 100	0.5 % + 100	2 % + 200 ^[2]
10.0000 A ^[4]	0.0001 A	11.9999	1.5 % + 100	1 % + 100	-

[1] Specifications are for sine wave inputs that are greater than 5 % of range.

[2] Input current (5 k ~ 10 kHz) < 220 mArms.

[3] The accuracy of ACI+DCI is equal to ACI's with 10 more digits added.

[4] The specifications are guaranteed to 10 A. A beeping alarm will go off when the input current being measured is higher than 10 A.

Frequency Accuracy

Rate	10Hz to 1MHz ^[1]
Slow (>10 Hz)	0.01 % + 3
Med (>20 Hz)	
Fast (>200 Hz)	

[1] 750 Vac range limited to 100 kHz or 8x10⁷ Volt-Hz on other ranges.

Voltage Measurement Sensitivity

Range	10 Hz to 100kHz	100kHz to 1MHz
200 mV	40 mVrms	0.3 Vrms
2 V	At least 5 % of voltage range	1 Vrms
20 V to 750 V	At least 5 % of voltage range	At least 5 % of voltage range

* Note: When the input level is greater than the full scale range, "VAC OL", will be shown.

Current Measurement Sensitivity

Range	20 Hz to 10 kHz
20 mA ~ 10 A	At least 5 % of current range

* Note: When the input level is greater than the full scale range, "IAC OL", will be shown.

Thermocouple Specifications

Type	Measurement Range	Accuracy
J, K, T	-200 °C to 0 °C	0.6 °C
	0 °C to +300 °C	0.3 °C

*Specifications do not include probe accuracy.

Capacitance

Range	Resolution	Full Scale	Test Current	Accuracy
10.00 nF ^[1]	0.01 nF	11.99	10 µA	2.0 % + 10
100.0 nF	0.1 nF	119.9	10 µA	2.0 % + 4
1.000 µF	0.001 µF	1.199	100 µA	2.0 % + 4
10.00 µF	0.01 µF	11.99	1 mA	2.0 % + 4
100.0 µF	0.1 µF	119.9	1 mA	2.0 % + 4

*Specifications are for film Capacitance inputs that are greater than 10 % range.

[1]10 nF capacitance measurements may be affected by the stray capacitance on the test cables. Before testing, use the REL function to compensate for the stray capacitance from the test cables.

Additional Specifications

The Additional Specifications apply to the previous Specifications chapter on the condition of the unit operating in the temperature exceeding 18°C to 28°C.

DC Voltage

Measurement method: Sigma Delta A-to-D converter.

Input protection: 1000V peak on all ranges.

Range	Typical Input Impedance
200 mV / 2 V	10.0 MΩ ± 2 % or >10 GΩ
20 V	11.1 MΩ ± 2 %
200 V	10.1 MΩ ± 2 %
1000 V	10.0 MΩ ± 2 %

Rate	Additional Rate Error Count
Med	50
Fast	200

DC Current

* 20 mA to 2 A range has a 3 V voltage limit protection and F2.5 A / 1000 V fuse protection.

And 10A range has a F12 A / 1000 V fuse protection.

Shunt resistance

Range	Shunt	Burden voltage
20 mA	1.1 Ω	< 0.08 V
200 mA	1.1 Ω	< 0.8 V
2 A	0.1 Ω	< 0.8 V
10 A	0.01 Ω	< 0.6 V

Rate	Additional Rate Error Count
Med	60
Fast	200

AC Voltage (AC Coupling Mode/AC + DC Coupling Mode)

Measurement method: AC coupled true RMS - measure the AC component with up to 400 VDC bias on any range.

Crest Factor: Maximum 3 at full scale.

Input Impedance: 1 MΩ ± 2 % in parallel with <100 pF on all ranges.

Maximum input voltage: 750 Vrms on all ranges.

Input protection: 1200 V peak on all ranges with gas discharge.

Rate		[1] Frequency			
Med		> 20 Hz			
Fast		> 200 Hz			
Rate	Range	Accuracy			
		20 Hz to 45 Hz	45 Hz to 10 kHz	10 kHz to 30 kHz	30 kHz to 100 kHz
Med	200.000 mV	1.0 %	0.3 %	1.5 %	5.0 %
		+ 200	+ 400	+ 800	+ 1200
	2.00000 V	1.0 %	0.2 %	1.0 %	3.0 %
		+ 200	+ 400	+ 400	+ 800
	20.0000 V	1.0 %	0.2 %	1.0 %	3.0 %
		+ 200	+ 400	+ 400	+ 800
	200.000 V	1.0 %	0.2 %	1.0 %	3.0 %
		+ 200	+ 400	+ 400	+ 800
	750.00 V	1.0 %	0.2 %	1.0 %	3. % +
		+ 200	+ 400	+ 400	800
Fast	200.000 mV	-	0.3 %	1.5 %	5.0 %
			+ 1000	+ 1000	+ 1500
	2.00000 V	-	0.2 %	1.0 %	3.0 %
			+ 500	+ 500	+ 1000
	20.0000 V	-	0.2 %	1.0 %	3.0 %
			+ 500	+ 500	+ 1000
	200.000 V	-	0.2 %	1.0 %	3.0 %
			+ 500	+ 500	+ 1000
	750.00 V	-	0.2 %	1.0 %	3.0 %
			+ 500	+ 500	+ 1000

*The accuracy of ACV+DCV is equal to ACV's with 10 more digits added.

[1] The accuracy of the AC voltage measurement is guaranteed only when the signal being measured has frequencies higher than what is listed here.

AC Current (AC Coupling Mode/AC + DC Coupling Mode)

Measurement method: Current to the fuse and current shunt, AC coupled true RMS measurement (measures the AC component only).

Crest factor: Maximum of 3 at full scale.

Rate	Range	Accuracy		
		20 Hz to 45 Hz	45 Hz to 2 kHz	2 kHz to 10kHz
Med	20.0000 mA	1.5 % + 400	0.5 % + 400	2.0 % + 800
	200.000 mA	1.5 % + 120	0.5 % + 120	2.0 % + 300
	2.00000 A	1.5 % + 120	0.5 % + 120	2.0 % + 300
	10.0000 A	2.0 % + 120	1.0 % + 120	-
Fast	20.0000 mA	-	0.5 % + 500	2.0 % + 1000
	200.000 mA	-	0.5 % + 200	2.0 % + 500
	2.00000 A	-	0.5 % + 200	2.0 % + 500
	10.0000 A	-	1.0 % + 200	-

Rate	Additional Rate Error Count
Med	50
Fast	500

Shunt resistance

Range	SHUNT	Burden voltage
20 mA	1.1 Ω	< 0.08 V
200 mA	1.1 Ω	< 0.8 V
2 A	0.1 Ω	< 0.8 V
10 A	0.01 Ω	< 0.6 V

Resistance (2-wire resistance and 4-wire resistance)

Measurement method: 2-wire resistance or 4-wire resistance.

Open-circuit voltage: Approximately 7.5 VDC.

Input protection: 500 V_{peak} on all ranges.

Diode

Measurement method: 1 mA ± 2 % constant current source.

Open-circuit voltage: Approximately 7.5 VDC.

Input protection: Input protection of 500 V peak.

Rate	Additional Rate Error Count
Med	50
Fast	200

Continuity

Measurement method: 1 mA ± 2 % constant current source.

Open-circuit voltage: Approximately 7.5 VDC.

Input protection: Input protection of 500 V peak.

Continuity threshold: 0 Ω to 2000 Ω.

Threshold step: 1 Ω.

Rate	Additional Rate Error Count
Med	60
Fast	200

Frequency

Measurement method: Reciprocal counting technique.

Input impedance: $1\text{ M}\Omega \pm 2\%$ in parallel with $< 100\text{ pF}$ on all ranges.

Maximum input voltage: $750\text{ V}_{\text{rms}}$ on all ranges.

Input protection: 1200 V peak on all ranges with gas discharge.

Refresh Rate	Gate Time(sec)
Slow	1
Med	0.1
Fast	0.01

Capacitance

Measurement method: DC recharge & discharge.

Input protection: $500\text{ V}_{\text{peak}}$ on all ranges.

The capacitor under test (C_x) is charged using a constant current source. The time to charge C_x is recorded. The capacitor is then discharged using a known resistance and the discharge time is recorded. The value of the resistance depends on the capacitance range that is selected. The charge and discharge time is used to calculate the capacitance of C_x if the selected capacitance range is equal to or less than 10 nF . Only the charge time is used to calculate the capacitance of C_x if the selected capacitance range is equal to or greater than 100 nF .

As measuring capacitance with the DMM is effectively a DC measurement, the measured capacitance tends to be higher than what is measured by LCR meters.

For best measurement results, first perform a zeroing of the test leads when the cables are "open" to compensate for the test lead capacitance.

Measurement Noise Rejection

CMR (Common Mode Rejection) for 1 k Ω unbalance LO lead, 50 Hz / 60 Hz \pm 0.1 %: DC >120 dB, AC > 70 dB

Temperature Coefficients

Specified ambient temperature range accuracy is typically within the calibration temperature (Tcal) \pm 5 $^{\circ}$ C range. If the operating environment of the multimeter is within 0 $^{\circ}$ C to (Tcal)-5 $^{\circ}$ C or (Tcal)+5 $^{\circ}$ C to 50 $^{\circ}$ C (specification units/ $^{\circ}$ C), you must add the additional temperature coefficient errors to the accuracy specifications.

Temperature Coefficient = add \pm 0.15 x [the applicable accuracy]/ $^{\circ}$ C].

Dimensions

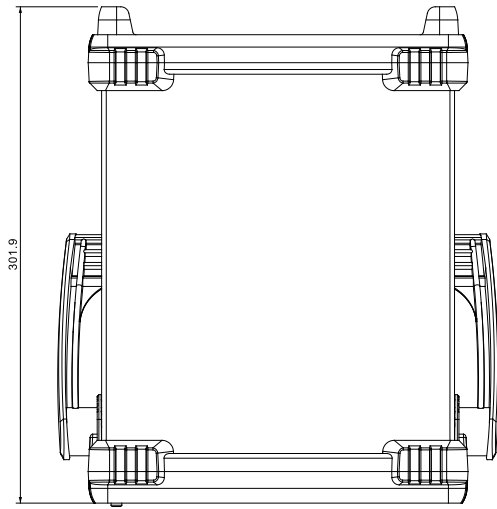

All dimensions are shown in millimeters.

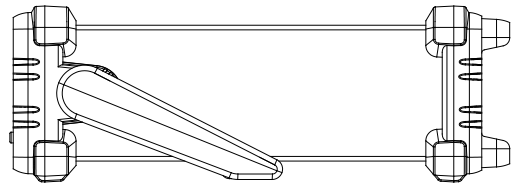
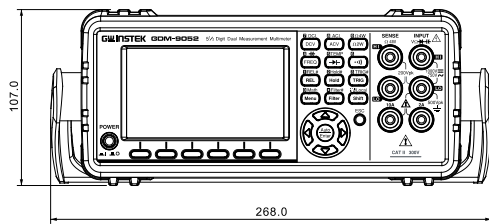

Declaration of Conformity

We

GOOD WILL INSTRUMENT CO., LTD.

declare that the CE marking mentioned product satisfies all the technical relations application to the product within the scope of council:

Directive: EMC; LVD; WEEE; RoHS

The product is in conformity with the following standards or other normative documents:

© EMC	
EN 61326-1 :	Electrical equipment for measurement, control and laboratory use — EMC requirements
Conducted & Radiated Emission EN 55011 / EN 55032	Electrical Fast Transients EN 61000-4-4
Current Harmonics EN 61000-3-2 / EN 61000-3-12	Surge Immunity EN 61000-4-5
Voltage Fluctuations EN 61000-3-3 / EN 61000-3-11	Conducted Susceptibility EN 61000-4-6
Electrostatic Discharge EN 61000-4-2	Power Frequency Magnetic Field EN 61000-4-8
Radiated Immunity EN 61000-4-3	Voltage Dip/ Interruption EN 61000-4-11 / EN 61000-4-34
© Safety	
EN 61010-1 :	Safety requirements for electrical equipment for measurement, control, and laboratory use - Part 1: General requirements

GOODWILL INSTRUMENT CO., LTD.

No. 7-1, Jhongsing Road, Tucheng District, New Taipei City 236, Taiwan

Tel: [+886-2-2268-0389](tel:+886-2-2268-0389)

Fax: [+886-2-2268-0639](tel:+886-2-2268-0639)

Web: <http://www.gwinstek.com>

Email: marketing@goodwill.com.tw

GOODWILL INSTRUMENT (SUZHOU) CO., LTD.

No. 521, Zhujiang Road, Snd, Suzhou Jiangsu 215011, China

Tel: [+86-512-6661-7177](tel:+86-512-6661-7177)

Fax: [+86-512-6661-7277](tel:+86-512-6661-7277)

Web: <http://www.instek.com.cn>

Email: marketing@instek.com.cn

GOODWILL INSTRUMENT EURO B.V.

De Run 5427A, 5504DG Veldhoven, The Netherlands

Tel: [+31-\(0\)40-2557790](tel:+31-(0)40-2557790)

Fax: [+31-\(0\)40-2541194](tel:+31-(0)40-2541194)

Email: sales@gw-instek.eu

INDEX

Accessories	11	EN 61010	
Command IEE488.2 commands	152	pollution degree	8
Command set		Environment	
CALCulate commands.....	142	operation	7
CONFigure commands.....	131	storage	8
CONFigure2 commands.....	133	Frequency	
Measure commands.....	135	setting.....	45
Remote commands	151	Front panel	
SENSe commands.....	138	overview	13, 21
STATus report commands	151	fuse	
SYSTem related commands	148	rating.....	157
TRIGger commands	145	Fuse	
Continuity		AC fuse replacement.....	157
setting	42, 49	current fuse replacement	158, 159
Crest factor.....	34, 35	safety instruction	7
Current		Getting Started chapter	9
setting	36	Indicator	
dB		reading.....	28
setting	78	Main features	10
Declaration of conformity	178	Math	
Digital filter		1/X	90, 92
setting	75	setting.....	78, 85, 88, 90, 92
window.....	76	Measurement keys	
Digital I/O		overview	15
Compare application	95, 97	Period	
configuration	95	setting.....	45
User mode.....	97	Rear panel	
Diode test		overview	19
setting	44	Refresh rate	27, 60
Disposal instructions.....	8	Relative value	
Dual measurement		setting.....	68
operation.....	57	Remote control	
overview.....	57	Command list....	125, 126, 127, 128, 129, 130

Command syntax	122	setting	52, 55
Resistance		Thermocouple	
setting.....	39	junction setting	54
RS-232C configuration.....	116	setting	53
Safety instruction		Trigger	
fuse.....	7	external	73
symbol	5	Triggering	29
Specifications	166	Voltage	
Dimensions.....	177	setting	30
Status system	154	W	
Table of contents	3	setting	78
Temperature			